

6 & 8 VERSIONS

8 VERSION SHOWN

CIRCUIT 1
(8 CKTS VERSION)

CIRCUIT 1
(6 CKTS VERSION)

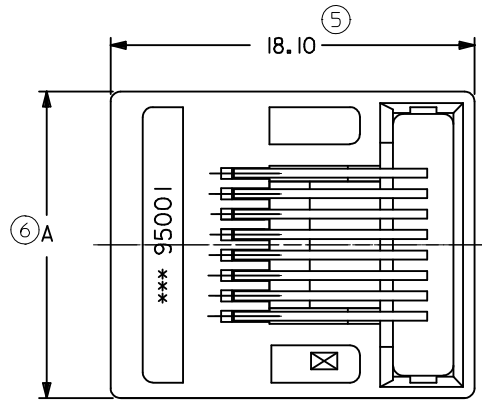
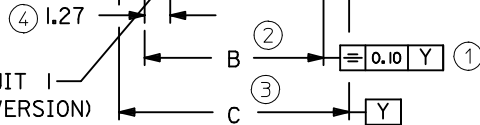

VIEW Z

4 VERSION ONLY

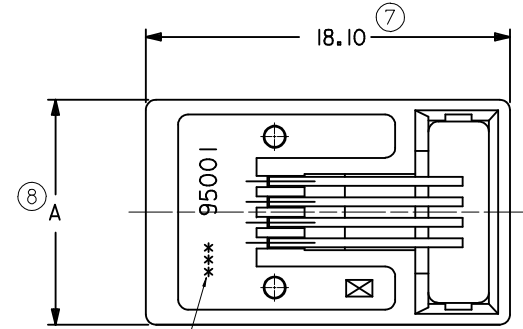

NOTE 5

NOTES :

1- MATERIAL:

- HOUSING: LCP GLASS FILLED UL 94V-0, COLOUR BLACK.
- TERMINAL: COPPER ALLOY
- BASE FINISH: NICKEL
- CONTACT SURFACE FINISH:
GOLD
OR
GOLD FLASH OVER PALLADIUM NICKEL.

- EXCEEDS PRODUCT REQUIREMENTS BASED ON PS-95501
- 2- JACK FOR MATING WITH F.C.C. 68 PLUGS 90075 MOLEX SERIES.
- 3- PRODUCT SPECIFICATION PS-95501.
- 4- PACKAGING SPECIFICATION PK-95001: STANDARD PACKAGING SHEET 1.
SPECIAL PACKAGING SHEET 2. TUBE PACKAGING SHEET 3.
- 5- MANUFACTURING I.D. CAN BE EITHER MXF, MG OR MXI.
- 6- RECOMMENDED PCB THICKNESS: 1.57mm
INSPECTION NUMBERS USED: 1 - 50
LAST INSPECTION NUMBER: 21

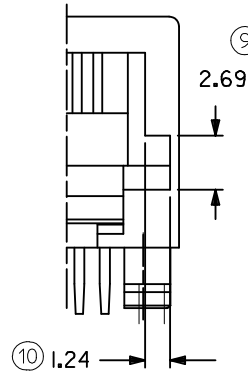

OPTIONAL
KEYING

CIRCUIT 1
(4 CKTS VERSION)

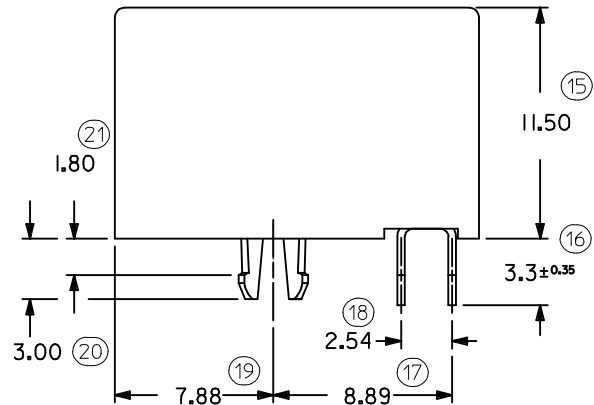
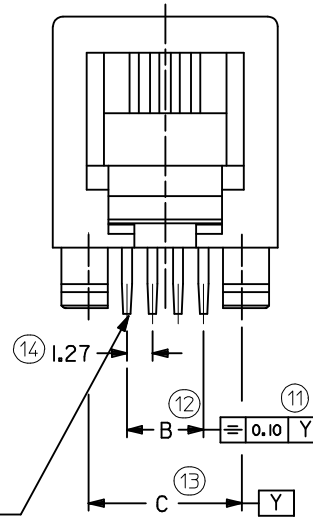

DIM.	TYPE	POS. 4		POS. 6		POS. 8
		4 CKTS.	4 CKTS.	6 CKTS.	8 CKTS.	8 CKTS.
A		11.18	13.21	13.21	15.24	
C		7.62	10.16	10.16	11.43	
B		3.81	3.81	6.35	8.89	

MODIFIED NOTES.

EC NO: IPG2012-0602	2012/03/30
DRW:DBYRNES	2012/03/30
CHKD:MSHAHAN	2012/03/30
APPR:EFOLAN	2012/06/26

QUALITY SYMBOLS	DESCRIPTION
▼ = 0	
∇ = 0	

GENERAL TOLERANCES (UNLESS SPECIFIED)	
	mm INCH
4 PLACES	± --- ± ---
3 PLACES	± --- ± ---
2 PLACES	± 0.15 ± ---
1 PLACE	± 0.25 ± ---
ANGULAR ± --- °	

DRAFT WHERE APPLICABLE
MUST REMAIN
WITHIN DIMENSIONS

DIMENSION STYLE	
MM ONLY	
DRAWN BY	DATE
DBYRNES	2006/08/02
CHECKED BY	DATE
EOMAHONY	2006/08/12
APPROVED BY	DATE
EOMAHONY	2006/08/12
MATERIAL NO.	
SEE CHART, SHEETS 4 & 5	

SCALE	DESIGN UNITS	THIRD ANGLE PROJECTION
4:1	METRIC	
TITLE		
R/A LOW PROFILE PC JACK 4,6,8 CKTS SIZE THROUGH HOLE VERSION		
MOLEX MOLEX INCORPORATED		
DOCUMENT NO.	SHEET NO.	
SD-95501-001	1 OF 5	
THIS DRAWING CONTAINS INFORMATION THAT IS PROPRIETARY TO MOLEX INCORPORATED AND SHOULD NOT BE USED WITHOUT WRITTEN PERMISSION		

TYPE \ DIM.	POS. 4	POS. 6		POS. 8
	4 CKTS.	4 CKTS.	6 CKTS.	8 CKTS.
Y ±0.05	7.62	10.16	10.16	11.43
X ±0.05	3.81	3.81	6.35	8.89

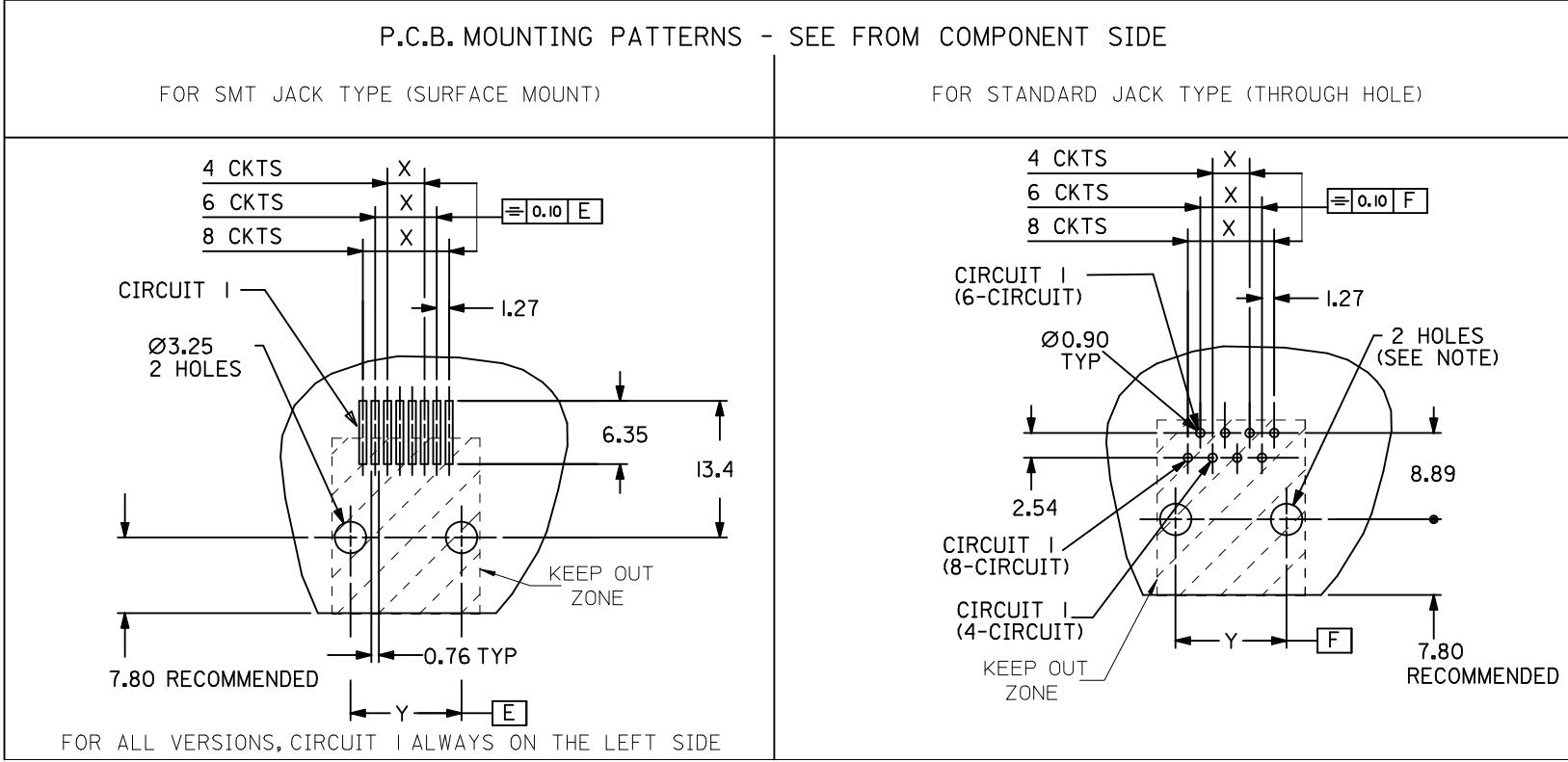

NOTE:
 FOR CONVECTION SOLDERING: DIA 3.25±0.05
 FOR WAVE SOLDERING: DIA 3.20±0.10
 ALL DIMENSIONS REF DIMENSIONS

REMOVED INCHES EC NO: E2012-0079 DRWN: JOCONNOR 2011/02/23 CHKD: APPR: EFOLAN 2011/09/28	QUALITY SYMBOLS ▽=0 ◻=0	GENERAL TOLERANCES (UNLESS SPECIFIED) mm INCH 4 PLACES ± --- ± --- 3 PLACES ± --- ± --- 2 PLACES ± 0.15 ± --- 1 PLACE ± 0.25 ± --- ANGULAR ± ---°	DIMENSION STYLE MM ONLY DRAWN BY: DBYRNES DATE: 2006/08/02 CHECKED BY: EOMAHONY DATE: 2006/08/12 APPROVED BY: EOMAHONY DATE: 2006/08/12	SCALE: 2:1 DESIGN UNITS: METRIC THIRD ANGLE PROJECTION	TITLE: R/A LOW PROFILE JACK PC JACK 4,6,8 CKT SIZE SMT AND STANDARD VERSION MOLEX INCORPORATED DOCUMENT NO: SD-95501-001 SHEET NO: 3 OF 5	
	DRAFT WHERE APPLICABLE MUST REMAIN WITHIN DIMENSIONS	MATERIAL NO. SEE CHART SHEETS 4 & 5	SIZE: A3 THIS DRAWING CONTAINS INFORMATION THAT IS PROPRIETARY TO MOLEX INCORPORATED AND SHOULD NOT BE USED WITHOUT WRITTEN PERMISSION			

SPECIAL PACKAGING TUBE, SEE PACKAGING SPEC PK95001 SHEET 3



PART NO FOR JACK ASSEMBLY
THROUGH HOLE VERSION

PART NO FOR JACK ASSEMBLY
SMT VERSION

HOUSING SIZE	LOADED CONTACTS
4	4
6	4
6	6
8	8

LCP GLASS FILED 94V0,COLOR BLACK.							
NO KEY	TOOLED	KEY	TOOLED		TOOLED		TOOLED
NOT RIBBED	TOOLED	NOT RIBBED	TOOLED		TOOLED		TOOLED
95501-2401	X						
95501-2601	X						
95501-2611	X						
95501-2821	X						

LCP GLASS FILLED 94V0 COLOUR BLACK							
NO KEY	TOOLED	KEY	TOOLED	NO KEY	TOOLED	KEY	TOOLED
NOT RIBBED	TOOLED	NOT RIBBED	TOOLED	NOT RIBBED	TOOLED	NOT RIBBED	TOOLED
95501-6449	X						
95501-6649	X						
95501-6669	X						
95501-6889	X	95501-6890	X				

REMOVED OPTIONS EC NO: IPG2012-0602 DRW:DBYRNES 2012/03/30 CHKD:MSHAHAN 2012/03/30 APPR:EFOLAN 2012/06/26	QUALITY SYMBOLS  =0  =0	GENERAL TOLERANCES (UNLESS SPECIFIED)	DIMENSION STYLE MM ONLY	SCALE ---	DESIGN UNITS METRIC	 THIRD ANGLE PROJECTION																			
			<table border="1" style="width: 100%; border-collapse: collapse;"> <thead> <tr> <th></th> <th>mm</th> <th>INCH</th> </tr> </thead> <tbody> <tr> <td>4 PLACES</td> <td>± ---</td> <td>± ---</td> </tr> <tr> <td>3 PLACES</td> <td>± ---</td> <td>± ---</td> </tr> <tr> <td>2 PLACES</td> <td>± ---</td> <td>± ---</td> </tr> <tr> <td>1 PLACE</td> <td>± ---</td> <td>± ---</td> </tr> <tr> <td colspan="3" style="text-align: center;">ANGULAR ± ---°</td> </tr> </tbody> </table>		mm	INCH	4 PLACES	± ---	± ---	3 PLACES	± ---	± ---	2 PLACES	± ---	± ---	1 PLACE	± ---	± ---	ANGULAR ± ---°			DRAWN BY: DBYRNES DATE: 2006/08/02 CHECKED BY: EOMAHONY DATE: 2006/08/12 APPROVED BY: EOMAHONY DATE: 2006/08/12	TITLE LOW PROFILE R/A JACK STANDARD AND SMT VERSION TUBE PACKAGING		
		mm	INCH																						
	4 PLACES	± ---	± ---																						
3 PLACES	± ---	± ---																							
2 PLACES	± ---	± ---																							
1 PLACE	± ---	± ---																							
ANGULAR ± ---°																									
		DRAFT WHERE APPLICABLE MUST REMAIN WITHIN DIMENSIONS	MATERIAL NO. SEE CHART	DOCUMENT NO. SD-95501-001		SHEET NO. 5 OF 5																			
			SIZE A3	THIS DRAWING CONTAINS INFORMATION THAT IS PROPRIETARY TO MOLEX INCORPORATED AND SHOULD NOT BE USED WITHOUT WRITTEN PERMISSION																					