

## N-Channel Power MOSFET

900V, 4A, 4.0Ω

### FEATURES

- Low  $R_{DS(ON)}$  4Ω (Max.)
- Low gate charge typical @ 25nC (Typ.)
- Improve dV/dt capability

### APPLICATION

- High efficiency switch mode power Supply
- Lighting

KEY PERFORMANCE PARAMETERS		
PARAMETER	VALUE	UNIT
$V_{DS}$	900	V
$R_{DS(on)}$ (max)	4	Ω
$Q_g$	25	nC



**Notes:** Moisture sensitivity level: level 3. Per J-STD-020

ABSOLUTE MAXIMUM RATINGS ( $T_A = 25^\circ\text{C}$ unless otherwise noted)				
PARAMETER	SYMBOL	TO-220	ITO-220	UNIT
Drain-Source Voltage	$V_{DS}$	900		V
Gate-Source Voltage	$V_{GS}$	±30		V
Continuous Drain Current <sup>(Note 4)</sup>	$I_D$	$T_C = 25^\circ\text{C}$	4	4*
		$T_C = 100^\circ\text{C}$	2.2	2.2*
Pulsed Drain Current <sup>(Note 2)</sup>	$I_{DM}$	16	16 *	A
Total Power Dissipation @ $T_C = 25^\circ\text{C}$	$P_{DTOT}$	123	38.7	W
Single Pulsed Avalanche Energy <sup>(Note 3)</sup>	$E_{AS}$	474		mJ
Single Pulsed Avalanche Current <sup>(Note 3)</sup>	$I_{AS}$	4		A
Repetitive Avalanche Energy <sup>(Note 2)</sup>	$E_{AR}$	12.3		mJ
Peak Diode Recovery <sup>(Note 7)</sup>	dV/dt	4.5		V
Operating Junction and Storage Temperature Range	$T_J, T_{STG}$	- 55 to +150		°C

THERMAL PERFORMANCE				
PARAMETER	SYMBOL	TO-220	ITO-220	UNIT
Junction to Case Thermal Resistance	$R_{\theta JC}$	1.01	3.23	°C/W
Junction to Ambient Thermal Resistance	$R_{\theta JA}$	62.5		°C/W

**Notes:**  $R_{\theta JA}$  is the sum of the junction-to-case and case-to-ambient thermal resistances. The case thermal reference is defined at the solder mounting surface of the drain pins.  $R_{\theta JA}$  is guaranteed by design while  $R_{\theta CA}$  is determined by the user's board design.  $R_{\theta JA}$  shown below for single device operation on FR-4 PCB in still air.

<b>ELECTRICAL SPECIFICATIONS</b> ( $T_A = 25^\circ\text{C}$ unless otherwise noted)						
PARAMETER	CONDITIONS	SYMBOL	MIN	TYP	MAX	UNIT
<b>Static</b> (Note 4)						
Drain-Source Breakdown Voltage	$V_{GS} = 0V, I_D = 250\mu A$	$BV_{DSS}$	900	--	--	V
Gate Threshold Voltage	$V_{DS} = V_{GS}, I_D = 250\mu A$	$V_{GS(TH)}$	2	--	4	V
Gate Body Leakage	$V_{GS} = \pm 30V, V_{DS} = 0V$	$I_{GSS}$	--	--	$\pm 100$	nA
Zero Gate Voltage Drain Current	$V_{DS} = 900V, V_{GS} = 0V$	$I_{DSS}$	--	--	10	$\mu A$
Drain-Source On-State Resistance	$V_{GS} = 10V, I_D = 2.0A$	$R_{DS(on)}$	--	3.2	4.0	$\Omega$
Forward Transconductance	$V_{DS} = 30V, I_D = 2.0A$	$g_{fs}$	--	6	--	S
<b>Dynamic</b> (Note 5)						
Total Gate Charge	$V_{DS} = 720V, I_D = 4.0A, V_{GS} = 10V$	$Q_g$	--	25	--	nC
Gate-Source Charge		$Q_{gs}$	--	4.8	--	
Gate-Drain Charge		$Q_{gd}$	--	10.2	--	
Input Capacitance	$V_{DS} = 25V, V_{GS} = 0V, f = 1.0MHz$	$C_{iss}$	--	955	--	pF
Output Capacitance		$C_{oss}$	--	80	--	
Gate Resistance	$F = 1MHz, \text{open drain}$	$R_g$	--	--	4	$\Omega$
<b>Switching</b> (Note 6)						
Turn-On Delay Time	$V_{DD} = 450V, R_{GEN} = 25\Omega, I_D = 4.0A, V_{GS} = 10V,$	$t_{d(on)}$	--	49	--	ns
Turn-On Rise Time		$t_r$	--	38	--	
Turn-Off Delay Time		$t_{d(off)}$	--	146	--	
Turn-Off Fall Time		$t_f$	--	50	--	
<b>Source-Drain Diode</b> (Note 4)						
Forward On Voltage	$I_S = 4.0A, V_{GS} = 0V$	$V_{SD}$	--	--	1.5	V
Reverse Recovery Time	$V_{GS} = 0V, I_S = 4A$	$t_{rr}$	--	487	--	ns
Reverse Recovery Charge	$di_f/dt = 100A/\mu s$	$Q_{rr}$	--	2.8	--	$\mu C$

**Notes:**

1. Current limited by package.
2. Pulse width limited by the maximum junction temperature.
3.  $L = 56mH, I_{AS} = 4.0A, V_{DD} = 50V, R_G = 25\Omega, \text{Starting } T_J = 25^\circ\text{C}.$
4. Pulse test:  $PW \leq 300\mu s, \text{duty cycle} \leq 2\%.$
5. For DESIGN AID ONLY, not subject to production testing.
6. Switching time is essentially independent of operating temperature.
7.  $I_{SD} \leq 4A, di/dt \leq 200A/\mu s, V_{DD} \leq BV_{DSS}, \text{Starting } T_J = 25^\circ\text{C}.$

**ORDERING INFORMATION**

<b>PART NO.</b>	<b>PACKAGE</b>	<b>PACKING</b>
TSM4N90CZ C0G	TO-220	50pcs / Tube
TSM4N90CI C0G	ITO-220	50pcs / Tube

**Note:**

1. Compliant to RoHS Directive 2011/65/EU and in accordance to WEEE 2002/96/EC
2. Halogen-free according to IEC 61249-2-21 definition

**Not Recommended**

**CHARACTERISTICS CURVES**

( $T_C = 25^\circ\text{C}$  unless otherwise noted)

**Output Characteristics**

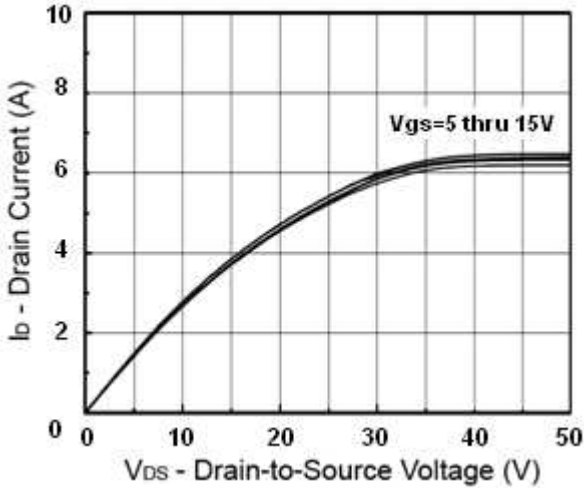

**Transfer Characteristics**

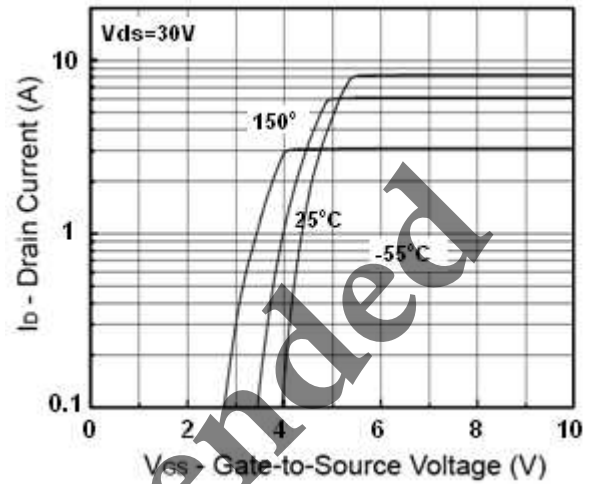

**On-Resistance vs. Drain Current**

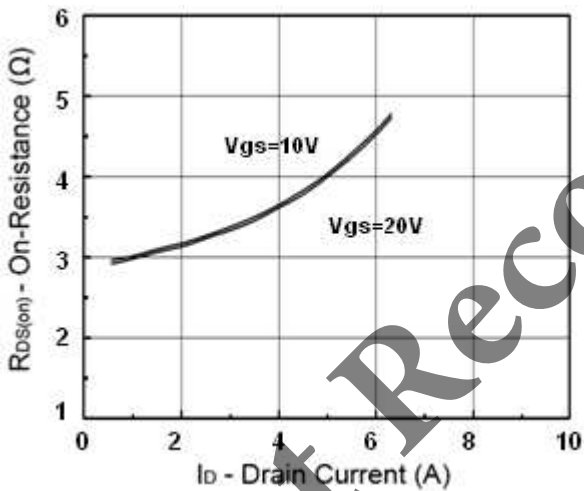

**Gate Charge**

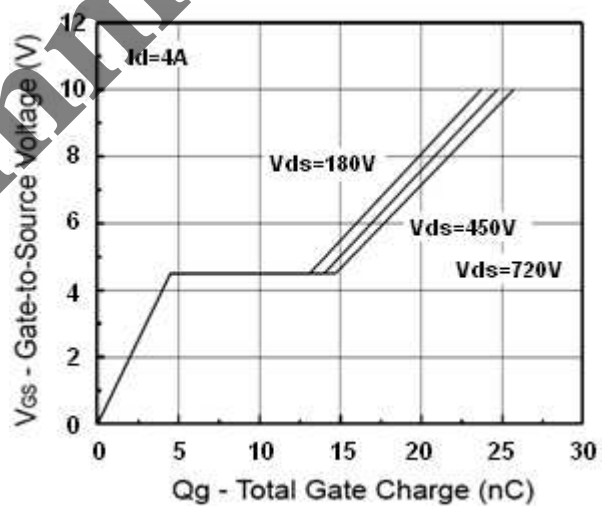

**On-Resistance vs. Junction Temperature**

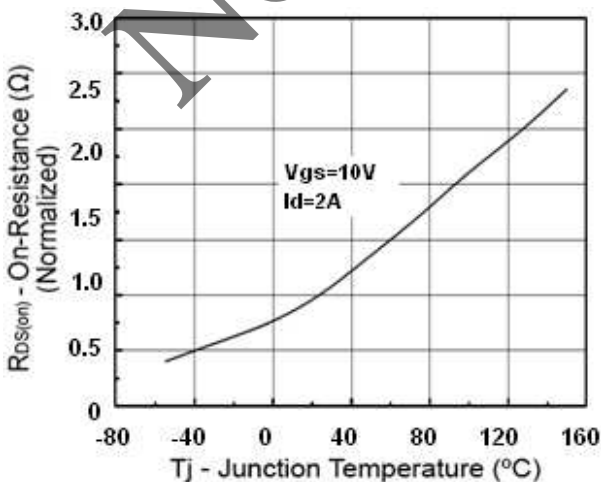

**Source-Drain Diode Forward Voltage**

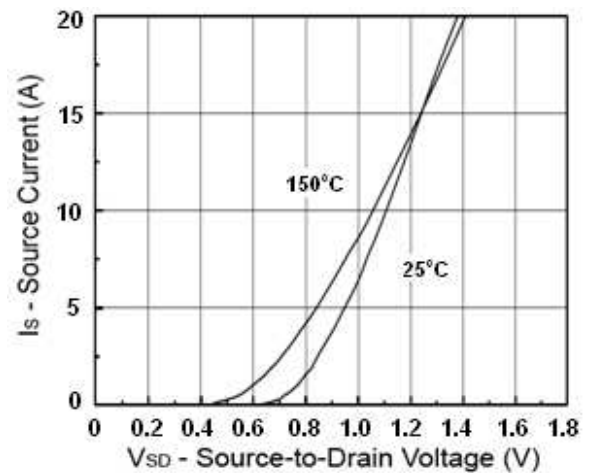

**CHARACTERISTICS CURVES**

( $T_C = 25^\circ\text{C}$  unless otherwise noted)

**Drain Current vs. Case Temperature**

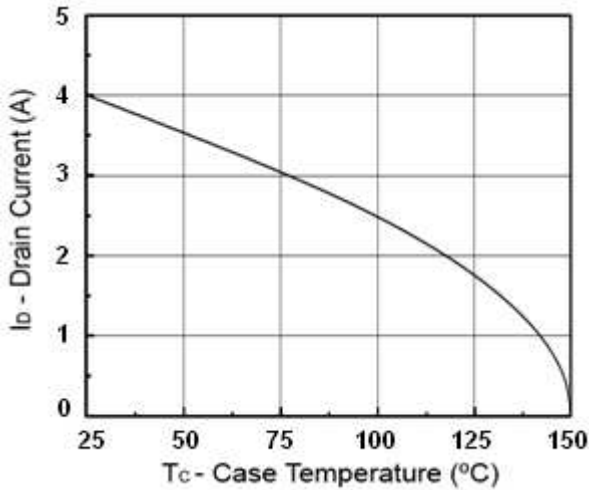

**$BV_{DSS}$  vs. Junction Temperature**

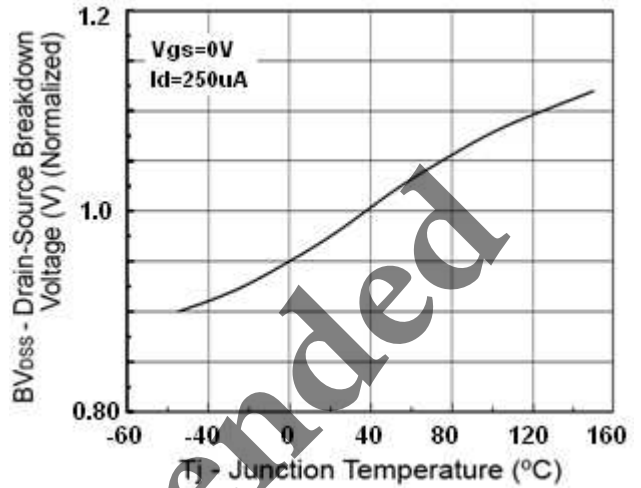

**Maximum Safe Operating Area**

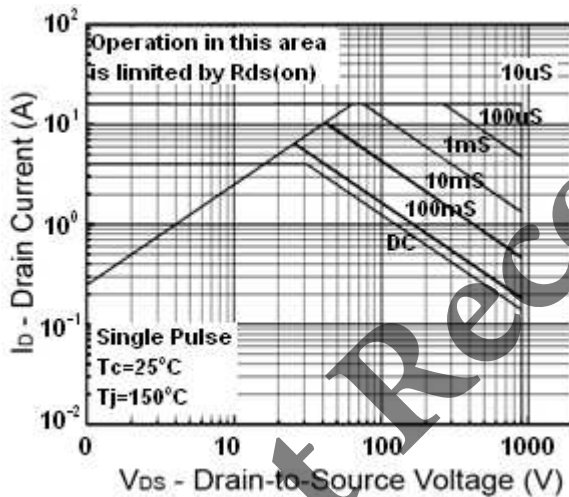

**Capacitance vs. Drain-Source Voltage**

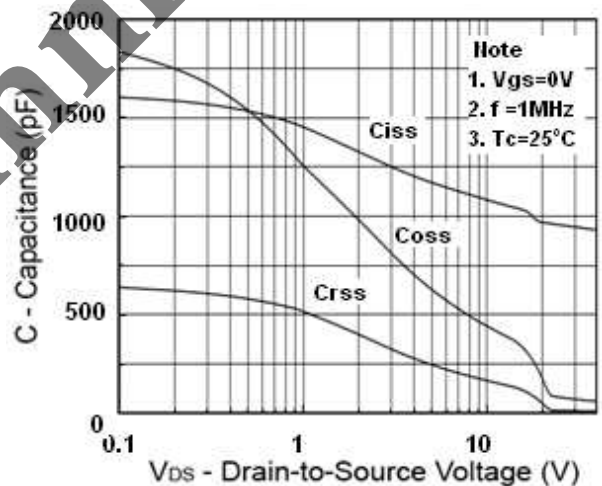

**Maximum Safe Operating Area (ITO-220)**

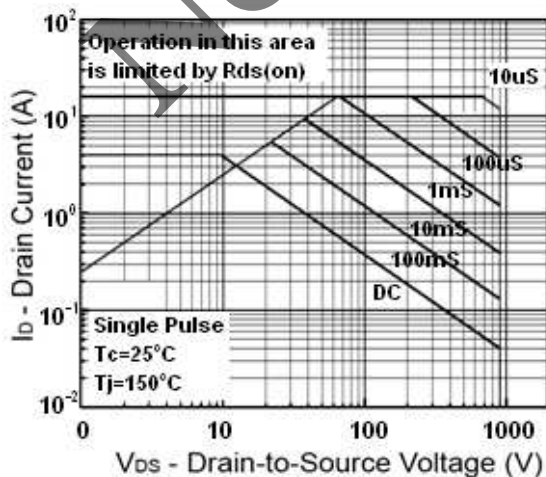

**CHARACTERISTICS CURVES**

( $T_C = 25^\circ\text{C}$  unless otherwise noted)

**Normalized Thermal Transient Impedance, Junction-to-Ambient (TO-220)**

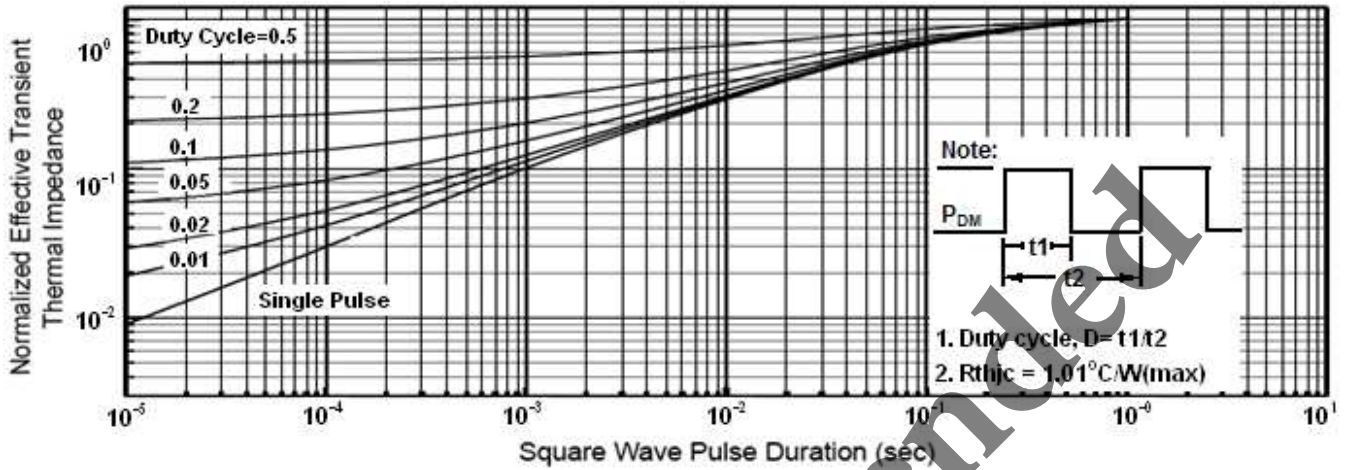

**Normalized Thermal Transient Impedance, Junction-to-Ambient (ITO-220)**

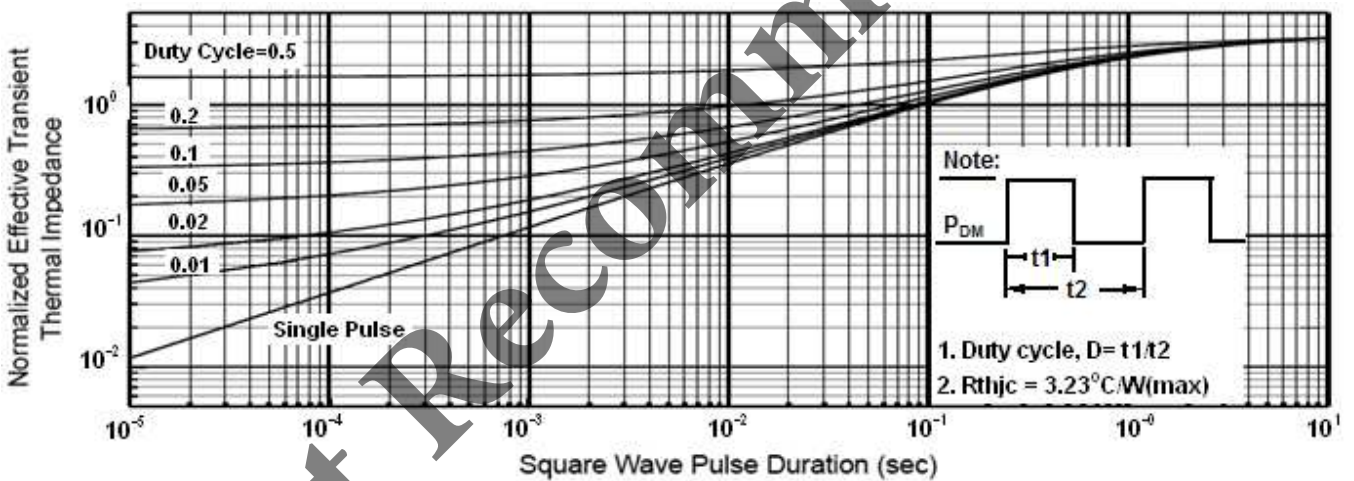

**PACKAGE OUTLINE DIMENSIONS** (Unit: Millimeters)

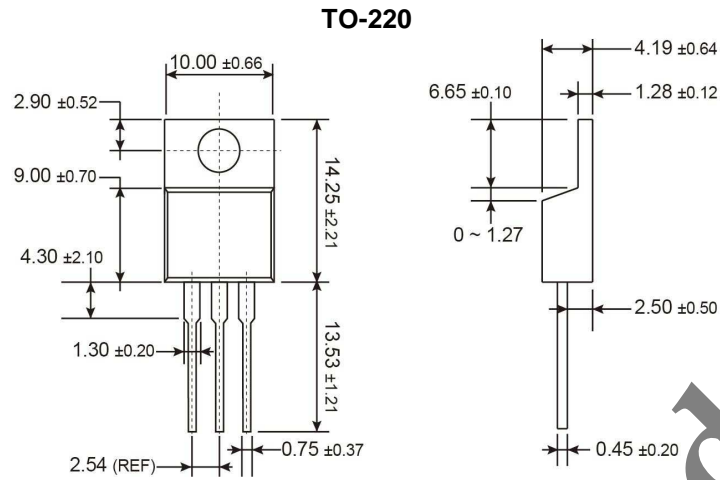

**MARKING DIAGRAM**

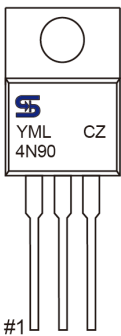

- Y** = Year Code
- M** = Month Code for Halogen Free Product
- O** =Jan    **P** =Feb    **Q** =Mar    **R** =Apr
- S** =May    **T** =Jun    **U** =Jul    **V** =Aug
- W** =Sep    **X** =Oct    **Y** =Nov    **Z** =Dec
- L** = Lot Code (1~9, A~Z)

Not Recommended

**PACKAGE OUTLINE DIMENSIONS** (Unit: Millimeters)

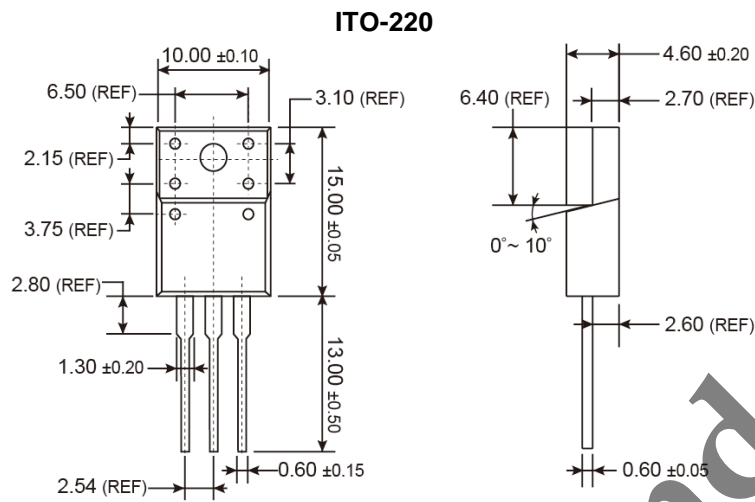

**MARKING DIAGRAM**

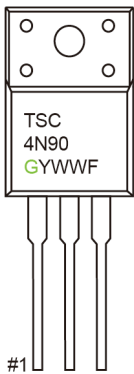

- G** = Halogen Free
- Y** = Year Code
- WW** = Week Code (01~52)
- F** = Factory Code

Not Recommended



**Not Recommended**

### **Notice**

Specifications of the products displayed herein are subject to change without notice. TSC or anyone on its behalf, assumes no responsibility or liability for any errors or inaccuracies.

Information contained herein is intended to provide a product description only. No license, express or implied, to any intellectual property rights is granted by this document. Except as provided in TSC's terms and conditions of sale for such products, TSC assumes no liability whatsoever, and disclaims any express or implied warranty, relating to sale and/or use of TSC products including liability or warranties relating to fitness for a particular purpose, merchantability, or infringement of any patent, copyright, or other intellectual property right.

The products shown herein are not designed for use in medical, life-saving, or life-sustaining applications. Customers using or selling these products for use in such applications do so at their own risk and agree to fully indemnify TSC for any damages resulting from such improper use or sale.