

1-Phase Solid State Contactors, 'U'- type connection



Benefits

- **Panel space savings.** The slimmest product in the range accommodates up to 25 AAC in a width of only 17.5 mm giving 25% space saving per SSR compared to 22.5 mm solutions.
- **Less maintenance costs.** Wire bonding technology reduces thermal and mechanical stresses of the output chips resulting in a larger number of operational cycles compared to other assembly technologies.
- **Low machine downtime.** Integrated overvoltage protection prevents the solid state relay from breaking down due to uncontrolled transients that may occur on the lines.
- **Ease of use.** The RGC ready-to-use solution is provided with integrated heatsink thus eliminating the need for the user to calculate the size of heatsink needed for adequate thermal dissipation.
- **Cost effective protection co-ordination.** The high I²t specification permits easy Type 2 protection co-ordination with B-type Miniature Circuit Breakers.
- **Fast wiring.** Power connections for models rated >30 A are equipped with terminals that can handle cables up to 25 mm² / AWG3 cables.
- **Accommodates UL508A requirements for Industrial Control Panels.** The RGC is certified as a listed product. All models carry a 100 kArms Short Circuit Current Rating.
- **Protection against SSR overheat.** Optional feature with integrated over temperature protection protects the RGC output from getting damaged in case of overheating. This feature is present by default on the variants with integrated fan and optional on other variants.

Description

This slimline range of solid state contactors is an evolution of solid state switches for which Carlo Gavazzi is very well known. The RG solid state contactors present a unique opportunity for panel space savings thanks to their very slim footprint.

The **RGC** is the ready-to-use range that is provided with an integrated heatsink. The smallest footprint occupies only a width of 17.5 mm with ratings up to 25 AAC.

The RGC output is protected against overvoltages by means of an integrated varistor. Control ON indication is provided through a green LED.

Specifications are at a surrounding temperature of 25°C unless otherwise specified.

Applications

Plastic injection machines, extrusion machines, blow moulding machines, thermoformers, dryers, electrical ovens, fryers, shrink tunnels, air handling units, sterilisation equipment, climatic chambers, ovens and furnaces, ambient heating.

Main features

- Ratings up to 660 VAC, 85 A @ T_A 40°C
- Up to 18000 A²s for I²t for protection coordination with M.C.Bs
- 100 kA short circuit current rating according to UL508
- Conformance to Railway standards

Order code

RGC1 **KGU**

 Enter the code option instead of . Refer to the selection guide section for valid part numbers.

| Code | Option | Description | Comments |
|--------------------------|------------|--|---------------------------------|
| R | - | Solid State Relay (RG) | |
| G | - | | |
| C | - | With integrated heatsink | |
| 1 | - | 1-pole switching | |
| <input type="checkbox"/> | A | Zero Cross switching (ZC) | |
| | B | Instant ON switching (IO) | |
| <input type="checkbox"/> | 23 | Rated voltage: 24-264 VAC, 800 Vp | |
| | 60 | Rated voltage: 42-660 VAC, 1200 Vp | |
| <input type="checkbox"/> | D | Control voltage: 3-32 VDC | 4-32 VDC for 600 VAC version |
| | A | Control voltage: 20-275 VAC, 24-190 VDC | |
| <input type="checkbox"/> | 15 | Rated current: 20 AAC (525 A ² s) | 17.5 mm wide, low depth |
| | 20 | Rated current: 23 AAC (525 A ² s) | 17.5 mm wide |
| | 25 | Rated current: 25 AAC (1800 A ² s) | 17.5 mm wide, low depth |
| | 30 | Rated current: 30 AAC (1800 A ² s) | 22.5 mm wide |
| | 40 | Rated current: 40 AAC (3200 A ² s) | 35 mm wide |
| | 42 | Rated current: 43 AAC (18000 A ² s) | 35 mm wide |
| | 60 | Rated current: 60 AAC (3200 A ² s) | 70 mm wide |
| | 62 | Rated current: 65 AAC (18000 A ² s) | 70 mm wide |
| K | - | Screw connection for control terminals | |
| G | - | Box clamp connection for power terminals | |
| U | - | SSR configuration | |
| <input type="checkbox"/> | - | | Single packaging |
| | X20 | Bulk packaging of 20 pcs. | Applicable only to: RGC..15, 25 |

Refer to page 3 for the Order Code of the RGC with integrated Over Temperature Protection

Order code - integrated Over Temperature Protection

RGC1 **60** **GGUP**

 Enter the code option instead of . Refer to selection guide section for valid part numbers.

| Code | Option | Description | Comments |
|--------------------------|--------|---|---------------------|
| R | - | Solid State Relay (RG) | |
| G | - | | |
| C | - | With integrated heatsink | |
| 1 | - | 1-pole switching | |
| <input type="checkbox"/> | A | Zero Cross switching (ZC) | |
| | B | Instant ON switching (IO) | |
| 60 | - | Rated voltage: 42-660 VAC, 1200 Vp | |
| <input type="checkbox"/> | D | Control voltage: 5-32 VDC | |
| | A | Control voltage: 20-275 VAC, 24-190 VDC | |
| <input type="checkbox"/> | 40 | Rated current: 40 AAC (3200 A ² s) | 35 mm wide |
| | 60 | Rated current: 60 AAC (3200 A ² s) | 70 mm wide |
| | 90 | Rated current: 85 AAC (6600 A ² s) | 70 mm wide with fan |
| G | - | Box clamp connection for control terminals | |
| G | - | Box clamp connection for power terminals | |
| U | - | SSR configuration | |
| P | - | Integrated Over Temperature Protection | |

Selection guide

For 17.5 mm wide and 22.5 mm wide variants:

| Rated voltage, Switching mode | Control voltage | Rated operational current @ 40°C | | | |
|----------------------------------|---------------------------|----------------------------------|----------------------------------|-----------------------------------|-----------------------------------|
| | | 20 AAC (525 A ² s) | 23 AAC (525 A ² s) | 25 AAC (1800 A ² s) | 30 AAC (1800 A ² s) |
| | | Product width | | | |
| | | 17.5 mm, low depth | 17.5 mm | 17.5 mm, low depth | 22.5 mm |
| 230 VAC, ZC | 3 - 32 VDC | RGC1A23D15KGU | RGC1A23D20KGU | RGC1A23D25KGU | RGC1A23D30KGU |
| | 20-275 VAC, 24-190 VDC | RGC1A23A15KGU | RGC1A23A20KGU | RGC1A23A25KGU | RGC1A23A30KGU |
| 600 VAC, ZC | 4 - 32 VDC | RGC1A60D15KGU | RGC1A60D20KGU | RGC1A60D25KGU | RGC1A60D30KGU |
| | 20-275 VAC, 24-190 VDC | RGC1A60A15KGU | RGC1A60A20KGU | RGC1A60A25KGU | RGC1A60A30KGU |
| 600 VAC, IO | 4 - 32 VDC | RGC1B60D15KGU | RGC1B60D20KGU | RGC1B60D25KGU | RGC1B60D30KGU |

For 35 mm wide and 70 mm wide variants:

| Rated voltage, Switching mode | Control voltage | Rated operational current @ 40°C | | | |
|----------------------------------|---------------------------|-----------------------------------|------------------------------------|-----------------------------------|------------------------------------|
| | | 40 AAC (3200 A ² s) | 43 AAC (18000 A ² s) | 60 AAC (3200 A ² s) | 65 AAC (18000 A ² s) |
| | | Product width | | | |
| | | 35 mm | 35 mm | 70 mm | 70 mm |
| 600 VAC, ZC | 4 - 32 VDC | RGC1A60D40KGU | RGC1A60D42KGU | RGC1A60D60KGU | RGC1A60D62KGU |
| | 20-275 VAC, 24-190 VDC | RGC1A60A40KGU | RGC1A60A42KGU | RGC1A60A60KGU | RGC1A60A62KGU |
| 600 VAC, IO | 4 - 32 VDC | RGC1B60D40KGU | RGC1B60D42KGU | RGC1B60D60KGU | RGC1B60D62KGU |

For variants with integrated Over Temperature Protection:

| Rated voltage, Switching mode | Control voltage | Rated operational current @ 40°C | | |
|----------------------------------|---------------------------|-----------------------------------|-----------------------------------|-----------------------------------|
| | | 40 AAC (3200 A ² s) | 60 AAC (3200 A ² s) | 85 AAC (6600 A ² s) |
| | | Product width | | |
| | | 35 mm | 70 mm | 70 mm + fan |
| 600 VAC, ZC | 5 - 32 VDC | RGC1A60D40GGUP | RGC1A60D60GGUP | RGC1A60D90GGUP |
| | 20-275 VAC, 24-190 VDC | RGC1A60A40GGUP | RGC1A60A60GGUP | RGC1A60A90GGUP |
| 600 VAC, IO | 5 - 32 VDC | - | - | RGC1B60D90GGUP |

KGU: input terminals = screw
GGUP: input terminals = box clamp

output terminals = box clamp
output terminals = box clamp

Selection guide - continued

For variants with bulk packaging of 20 pcs.

| Rated voltage, Switching mode | Control voltage | Rated operational current @ 40°C | | | |
|-------------------------------|-----------------|----------------------------------|--------------------|---|---|
| | | 20 AAC (525 A²s) | 25 AAC (1800 A²s) | - | - |
| | | Product width | | | |
| | | 17.5 mm, low depth | 17.5 mm, low depth | - | - |
| 600 VAC, ZC | 4 - 32 VDC | RGC1A60D15KGUX20 | RGC1A60D25KGUX20 | - | - |

Carlo Gavazzi further reading

| Information | Where to find it | Notes |
|-------------|---|---|
| Datasheet | https://gavazziautomation.com/images/PIM/DATASHEET/ENG/rgc.pdf | Solid state contactor, RGC with 'E' - type configuration |
| Datasheet | https://gavazziautomation.com/images/PIM/DATASHEET/ENG/RGS_U.pdf | Solid state relay, RGS series without integrated heatsink |

Structure

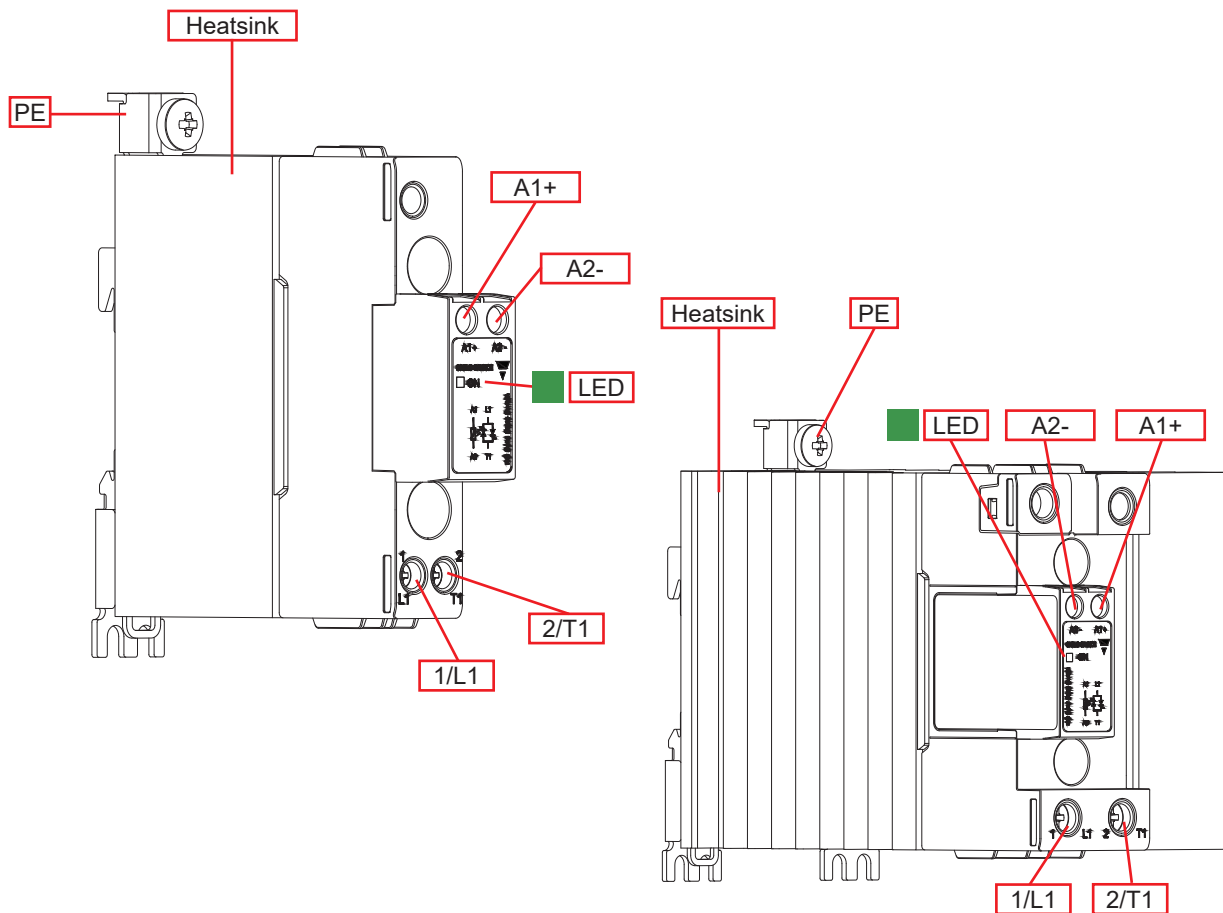

| Element | Component | Function |
|----------|---------------------|---|
| 1/L1 | Power connection | Mains connection |
| 2/T1 | Power connection | Load connection |
| A1+, A2- | Control connection | Terminals for control voltage |
| LED | ON indicator | Indicates presence of control voltage |
| Heatsink | Integrated heatsink | DIN rail mounting (panel mounting also possible) |
| PE | Protective Earth | Connection for Protective Earth, PE screw not provided with RGC |

Structure

RGC...40GGUP

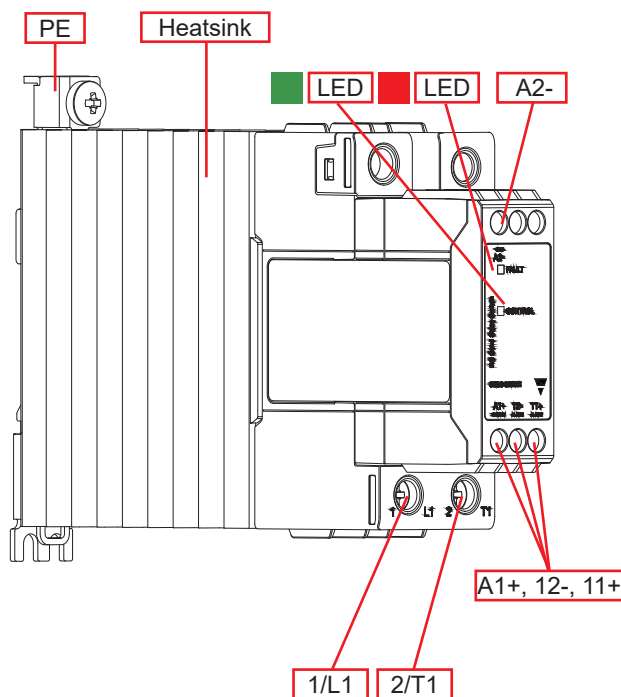

RGC...90GGUP*

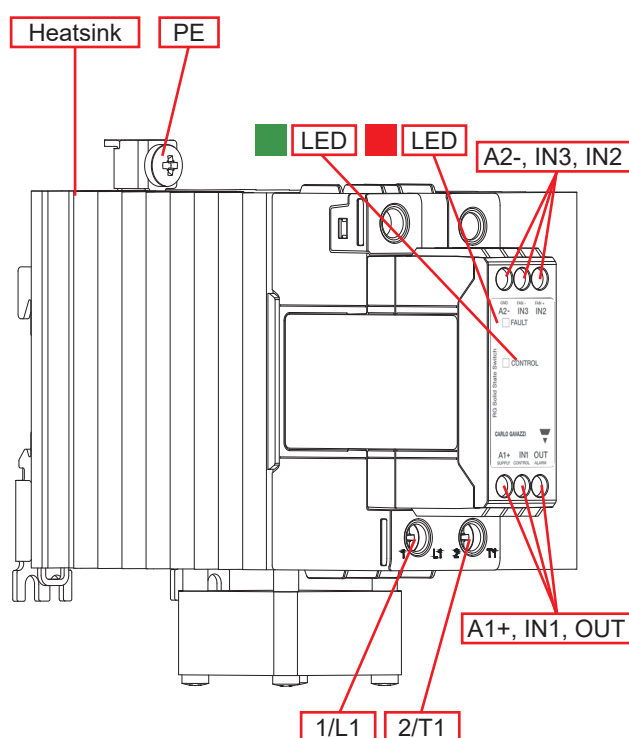

| Element | Component | Function |
|---------------|-----------------------|--|
| 1/L1 | Power connection | Mains connection |
| 2/T1 | Power connection | Load connection |
| A1+, A2- | Supply connection | Terminals for supply voltage |
| IN1 | Control connection | Terminals for control voltage (Only for RGC..D90GGUP) |
| 11+, 12-, OUT | Alarm output | Alarm output signal, Normally closed (OUT only for RGC..D90GGUP) |
| IN2, IN3 | Fan supply connection | Terminals for fan supply |
| LED, Green | CONTROL indicator | Indicates presence of control voltage |
| LED, Red | FAULT indicator | Indicates presence of an over temperature fault |
| Heatsink | Integrated heatsink | DIN rail mounting (panel mounting also possible) |
| PE | Protective Earth | Connection for Protective Earth, PE screw not provided with RGC |

* Refer to Terminal layout section for terminal labelling reference of RGC..A90GGUP

Features

General data

| | |
|-----------------------------|--|
| Material | PA66 or PA6 (UL94 V0), RAL7035 Glow wire ignition temperature and Glow wire flammability index conform to EN 60335-1 requirements |
| Mounting | DIN rail (panel mount also possible) |
| Touch protection | IP20 |
| Overvoltage category | III, 6 kV (1.2/50 μ s) rated impulse withstand voltage |
| Isolation | Input and Output to Case: 4000 Vrms Input to Output: 4000 Vrms, 2500 Vrms for RGC..D..P Input to FAN / Alarm Output: 2500 Vrms applicable only to RGC..A..P |
| Weight | RGC..15: approx. 260 g RGC..20: approx. 315 g RGC..25: approx. 260 g RGC..30: approx. 375 g RGC..4x / P: approx. 515 g / 581 g RGC..6x / P: approx. 972 g / 1020 g RGC..9xP approx. 1100 g |

Performance

Output specifications

| | RGC..15.. | RGC..20.. | RGC..25.. | RGC..30.. |
|--|-----------------------|----------------------|-----------------------|-----------------------|
| Max. operational current¹: AC-51 @ Ta=25°C | 20 AAC | 25.5 AAC | 30 AAC | 30 AAC |
| Max. operational current¹: AC-51 @ Ta=40°C | 20 AAC | 23 AAC | 25 AAC | 30 AAC |
| Max. operational current¹: AC-53a @ Ta=40°C | 5 AAC | 5 AAC | 5 AAC | 8 AAC |
| Operational frequency range | 45 to 65 Hz | | | |
| Output protection | Integrated varistor | | | |
| Leakage current @ rated voltage | <3 mAAC | | | |
| Minimum operational current | 150 mAAC | 150 mAAC | 250 mAAC | 250 mAAC |
| Repetitive overload current (Motor rating) UL508: Ta=40°C, t_{ON}=1 s, t_{OFF}=9 s, 50 cycles | 51 AAC | 60 AAC | 51 AAC | 84 AAC |
| Non-repetitive surge current (I_{TSM}), t=10 ms | 325 Ap | 325 Ap | 600 Ap | 600 Ap |
| I²t for fusing (t=10 ms), minimum | 525 A ² s | 525 A ² s | 1800 A ² s | 1800 A ² s |
| No. of motor starts per hour² (x=6, Tx=6s, F=50%) @ 40°C | 30 | | | |
| Power factor | >0.5 at rated voltage | | | |
| Critical dV/dt (@T_j init = 40°C) | 1000 V/ μ s | | | |

1. Refer to Current derating curves

2. Overload profile for AC-53a; I_e: AC-53a: x-Tx: F-S, where I_e = nominal current (AC-53a AAC), x = overload current factor, Tx = duration of overload current (s), F = duty cycle (%), S = number of starts per hour. Example; 5A: AC-53a: 6 - 6 : 50 - 30 = max. 30 starts for the RGC..15 with an overload profile of 30A for 6 seconds with a duty cycle of 50%

Output specifications - continued

| | RGC..40.. | RGC..42.. | RGC..60.. | RGC..62.. | RGC..90.. |
|---|-----------------------|------------------------|-----------------------|------------------------|-----------------------|
| Max. operational current ¹ : AC-51 @ Ta=25°C | 47 AAC | 50 AAC | 70 AAC | 75 AAC | 85 AAC |
| Max. operational current ¹ : AC-51 @ Ta=40°C | 40 AAC | 43 AAC | 60 AAC | 65 AAC | 85 AAC |
| Max. operational current ¹ : AC-53a @ Ta=40°C | 13 AAC | 16 AAC | 14.8 AAC | 20 AAC | 18 AAC |
| Operational frequency range | 45 to 65 Hz | | | | |
| Output protection | Integrated varistor | | | | |
| Leakage current @ rated voltage | <3 mAAC | | | | |
| Minimum operational current | 400 mAAC | 500 mAAC | 400 mAAC | 500 mAAC | 400 mAAC |
| Repetitive overload current (Motor rating) UL508: Ta=40°C, t _{ON} =1 s, t _{OFF} =9 s, 50 cycles | 126 AAC | 126 AAC | 126 AAC | 168 AAC | 168 AAC |
| Non-repetitive surge current (I _{TSM}), t=10 ms | 800 Ap | 1900 Ap | 800 Ap | 1900 Ap | 1150 Ap |
| I ² t for fusing (t=10 ms), minimum | 3200 A ² s | 18000 A ² s | 3200 A ² s | 18000 A ² s | 6600 A ² s |
| No. of motor starts per hour ² (x=6, Tx=6s, F=50%) @ 40°C | 30 | | | | |
| Power factor | >0.5 at rated voltage | | | | |
| Critical dV/dt (@T _j init = 40°C) | 1000 V/μs | | | | |

1. Refer to Current derating curves

2. Overload profile for AC-53a; I_e: AC-53a: x-Tx: F-S, where I_e = nominal current (AC-53a AAC), x = overload current factor, Tx = duration of overload current (s), F = duty cycle (%), S = number of starts per hour. Example; 5A: AC-53a: 6 - 6 : 50 - 30 = max. 30 starts for the RGC..15 with an overload profile of 30A for 6 seconds with a duty cycle of 50%

Output voltage specifications

| | RGC..23.. | RGC..60.. |
|---------------------------|---------------------------------|---------------------------------|
| Operational voltage range | 24-240 VAC, +10% -15% on max | 42-600 VAC, +10% -15% on max |
| Blocking voltage | 800 Vp | 1200 Vp |
| Internal varistor | 275 V | 625 V |

Motor ratings: HP (UL508) / kW (EN/IEC 60947-4-2) @ 40°C

| | 115 VAC | 230 VAC | 400 VAC | 480 VAC | 600 VAC |
|---------|---------------|---------------|--------------|--------------|--------------|
| RGC..15 | ½HP / 0.18kW | 1HP / 0.37kW | 2HP / 0.75kW | 3HP / 1.1kW | 3HP / 1.5kW |
| RGC..20 | ½HP / 0.18kW | 1½HP / 0.37kW | 2HP / 0.75kW | 3HP / 1.1kW | 3HP / 1.5kW |
| RGC..25 | ½HP / 0.18kW | 1HP / 0.37kW | 2HP / 0.75kW | 3HP / 1.1kW | 3HP / 1.5kW |
| RGC..30 | ¾HP / 0.37kW | 2HP / 1.1kW | 3HP / 1.5kW | 5HP / 2.2kW | 5HP / 3.7kW |
| RGC..40 | 1HP / 0.56kW | 3HP / 1.5kW | 5HP / 2.2kW | 5HP / 2.2kW | 7½HP / 4kW |
| RGC..42 | 1½HP / 0.56kW | 3HP / 1.5kW | 5HP / 2.2kW | 7½HP / 3.7kW | 10HP / 4kW |
| RGC..60 | 1½HP / 0.56kW | 3HP / 1.5kW | 5HP / 3kW | 7½HP / 4kW | 10HP / 4kW |
| RGC..62 | 2HP / 0.75kW | 5HP / 1.5kW | 7½HP / 4kW | 10HP / 4kW | 15HP / 5.5kW |
| RGC..90 | 2HP / 0.75kW | 5HP / 1.5kW | 7½HP / 4kW | 10HP / 4kW | 15HP / 5.5kW |

Input specifications

| | | RGC..D.. | RGC..A.. |
|--------------------------------------|------------------------|-----------------------------|-------------------------------------|
| Control voltage range ^{3,4} | RGC..23.. RGC..60.. | 3 - 32 VDC 4 - 32 VDC | 20-275 VAC, 24 (-10%) -190 VDC |
| Control voltage range | RGC...P | 5 - 32 VDC | |
| Pick-up voltage | RGC..23.. RGC..60.. | 3.0 VDC 3.8 VDC | 20 VAC/DC |
| Pick-up voltage | RGC..P | 5 VDC | 20 VAC/ 24 VDC |
| Drop-out voltage | | 1.0 VDC | 5 VAC/DC |
| Maximum reverse voltage | | 32 VDC | - |
| Maximum response time | RGC1A.. | 0.5 cycle + 500 μs @ 24 VDC | 2 cycles @ 230 VAC/110 VDC |
| Maximum response time | RGC1B.. | 350μs @ 24 VDC | - |
| Response time drop-out | | 0.5 cycle + 500 μs @ 24 VDC | 0.5 cycle + 40 μs @ 230 VAC/110 VDC |
| Input current @ 40°C | | See diagrams below | |

3. DC control to be supplied by class 2 power source according to UL1310

4. For GL approved models control range for RGC1.23... is 4-32VDC and for RGC1.60... 5-32VDC

Input current vs. input voltage

RGC..D

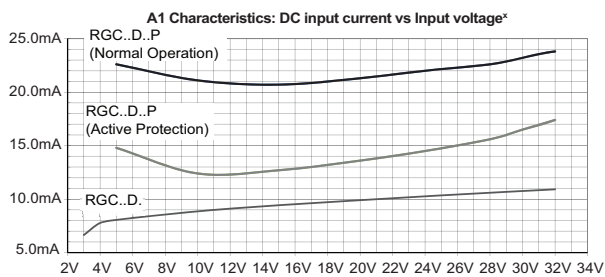

x: Input currents for RGC1..D15, RGC1..D20, RGC1..D25, RGC1..D30, RGC1..D4x, RGC1..D6x

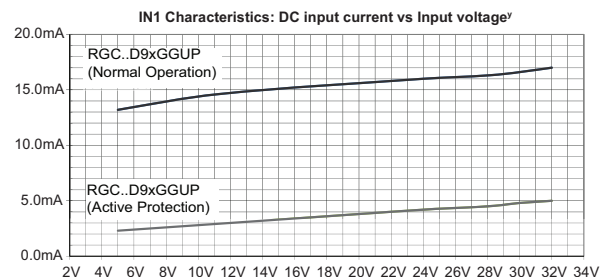

y: input currents valid only for RGC1..D90GGUP

RGC..A

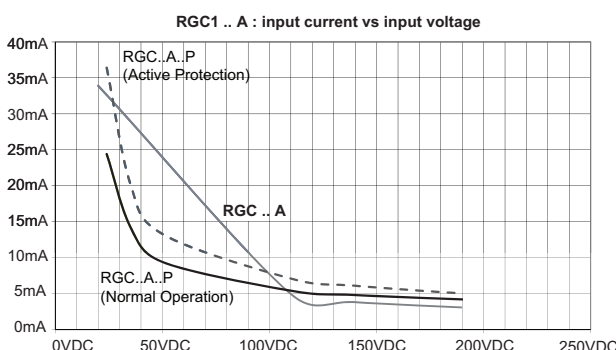
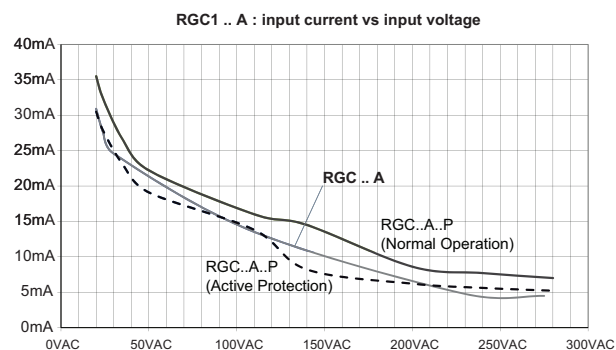

Overtemperature alarm specifications - RGC..P

| | RGC..D..P | RGC..A..P |
|---|---|--------------------------------|
| Output type | PNP open collector | Potential Free |
| Normal state | Closed | |
| Visual indication | Continuous red LED when fault (over temperature) is present | |
| Maximum current rating | 50 mADC | |
| Rated voltage, Ua (11, 12, OUT) ^{5, 6} | 24 VDC -15%, +20% | |
| Rated supply voltage, Us (A1) only for RGC..D90GGUP | 24V DC \pm 10% | N/A |
| Fan supply rating, Uf (IN2, IN3) only for RGC..A90GGUP | N/A | 24 VDC \pm 10%, 50mA nominal |
| Alarm voltage drop | | |
| | Typical Maximum | 1.8 VDC 3.5 VDC |
| | 2.8 VDC 4.0 VDC | |

5. According to EN 61131-2: 2003. DC supply for alarm signal should be supplied from a Class 2 power source

6. Maximum voltage to be applied between 11+ and 12- (Ua) terminals should be 35VDC maximum with reference to A2-

Output power dissipation

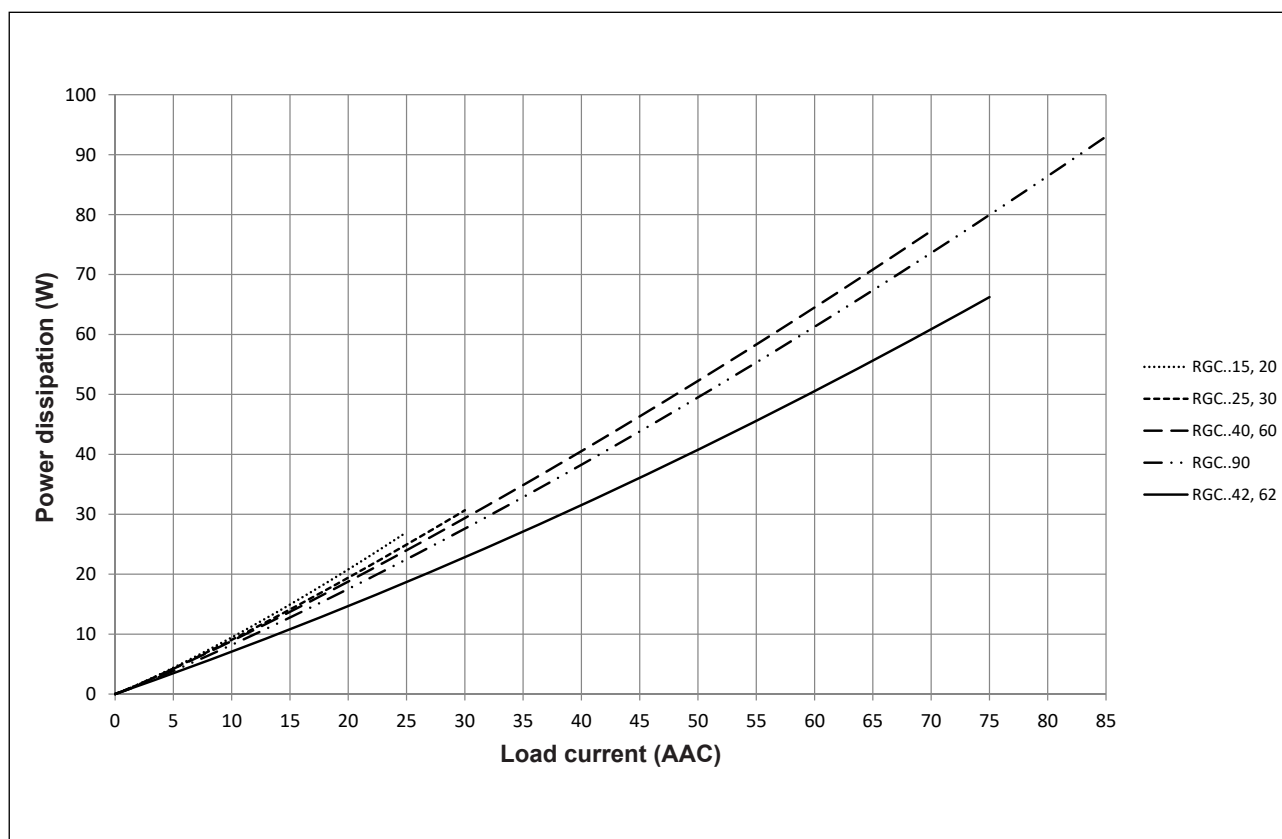

Current derating

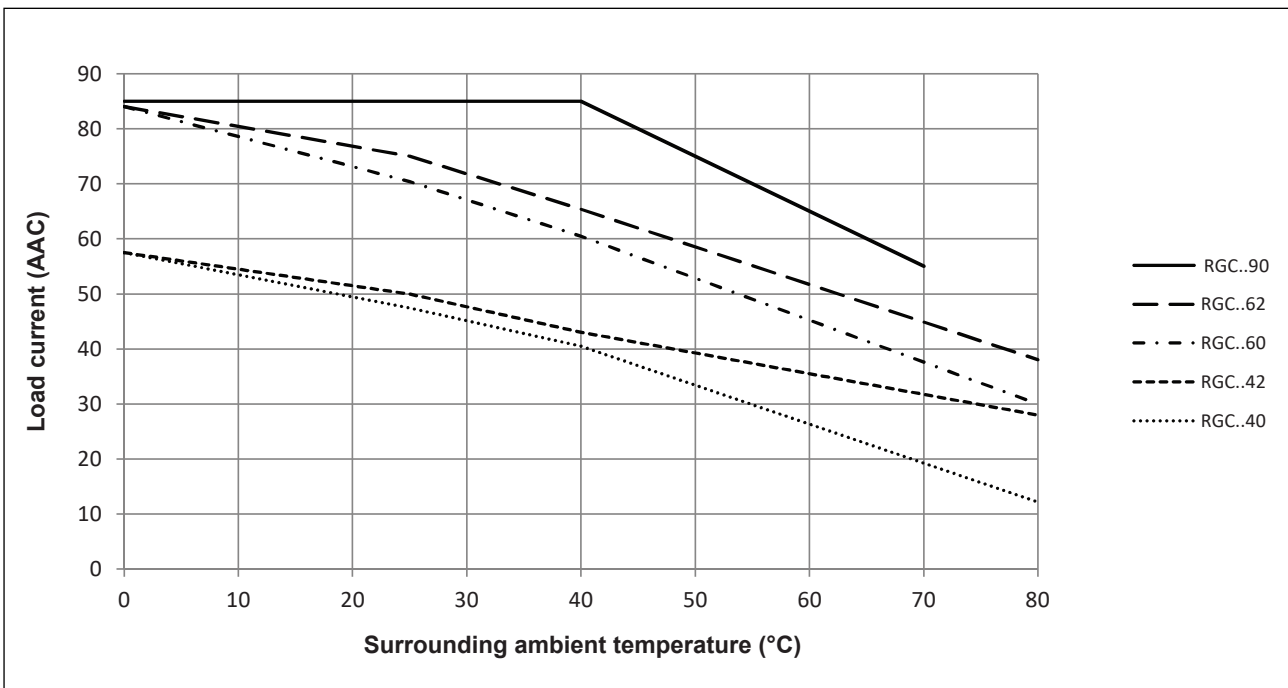
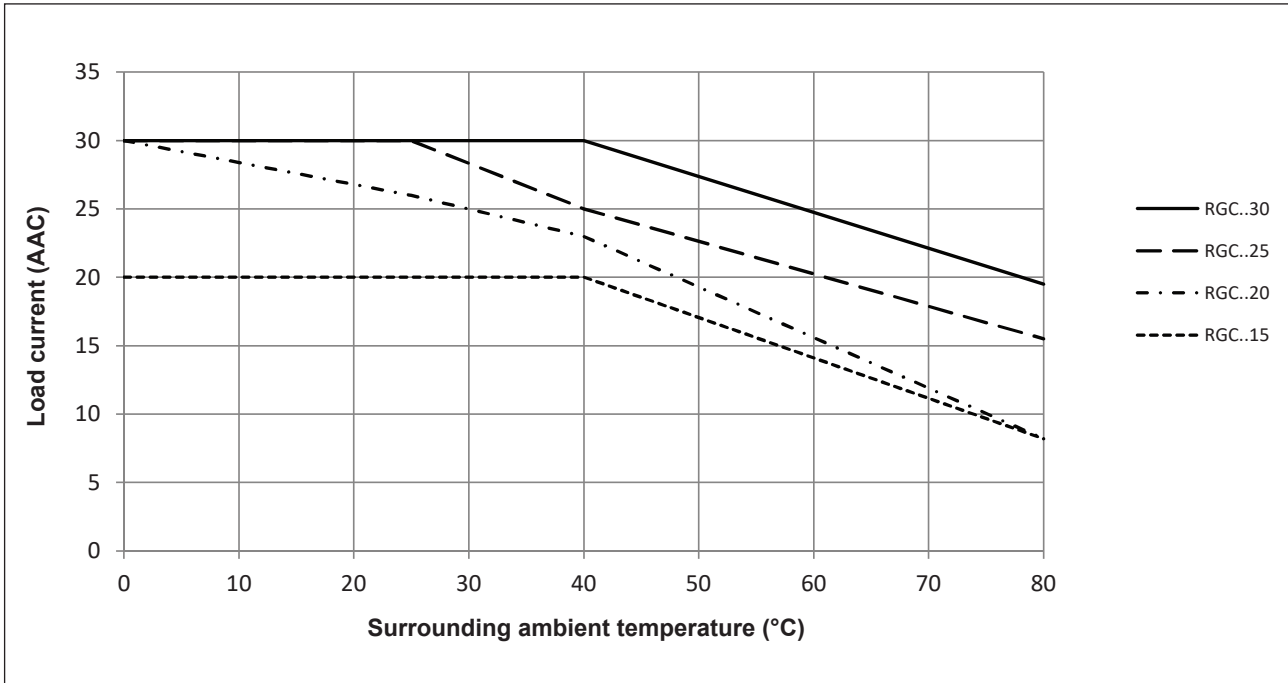

RGC...P models max. operating temperature is + 70°C / + 158°F

Derating vs. spacing curves

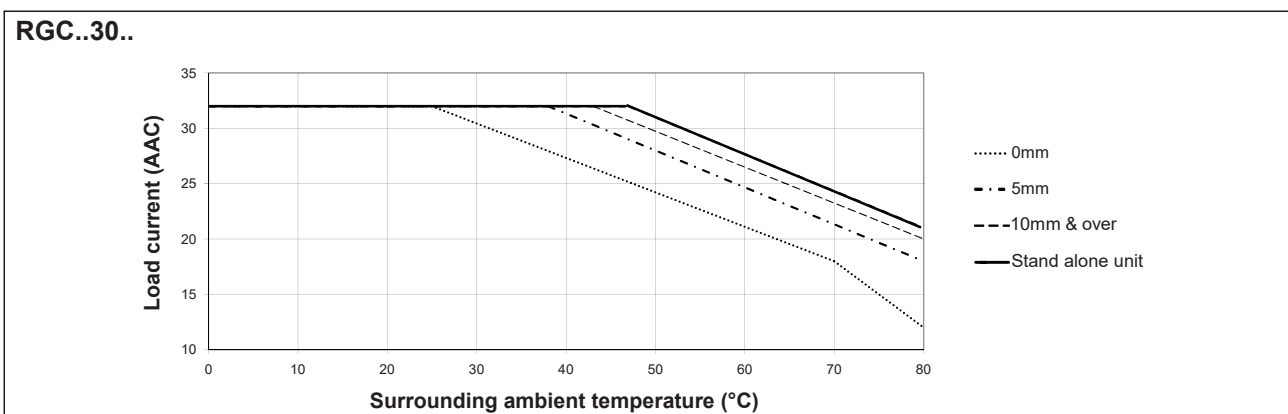
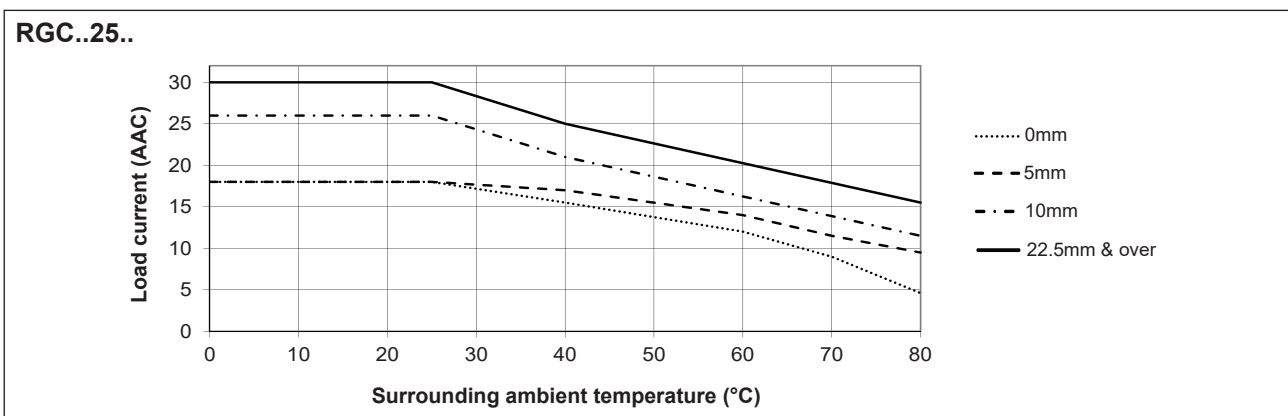
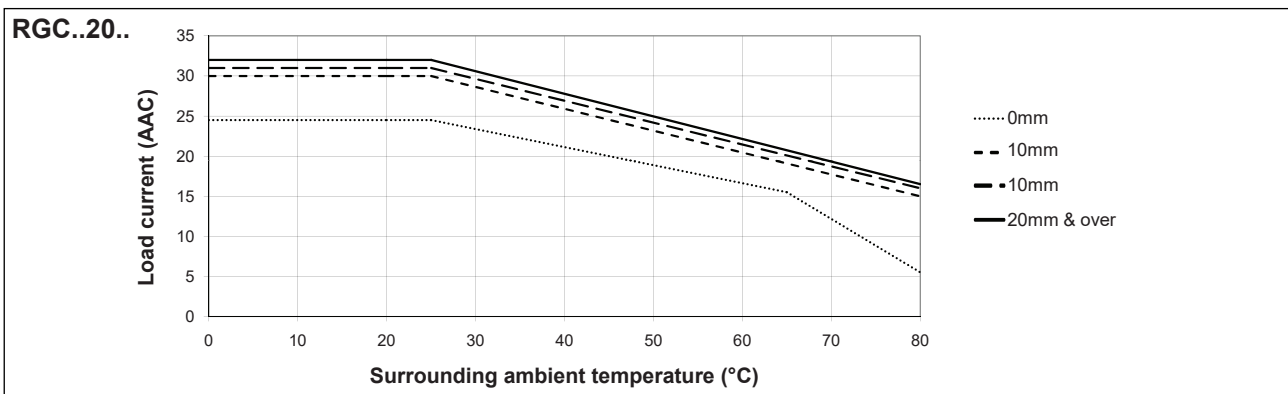
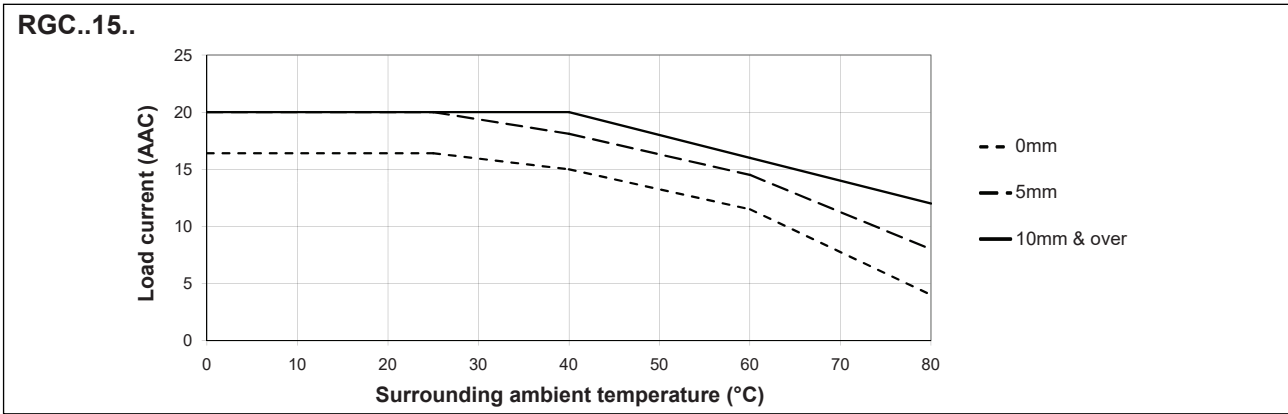



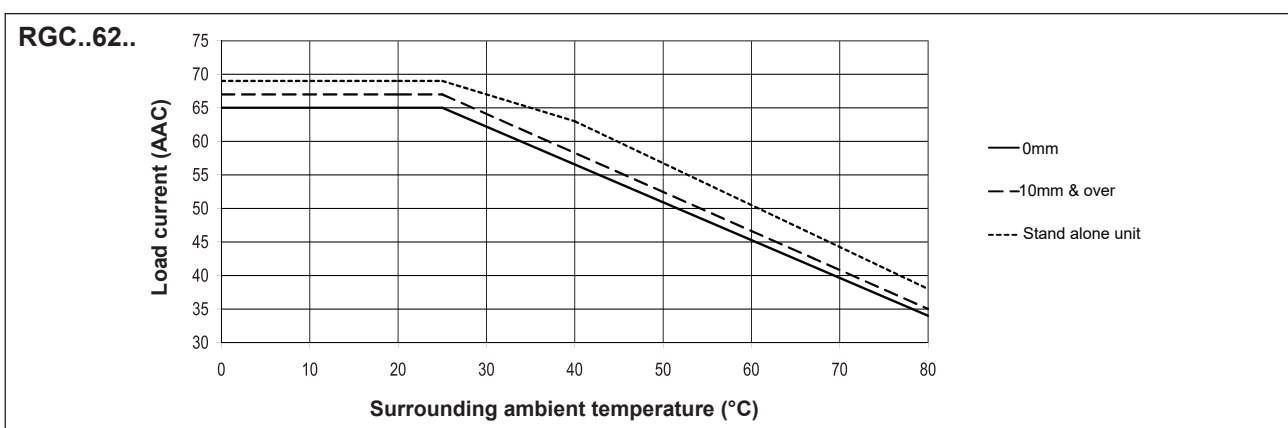
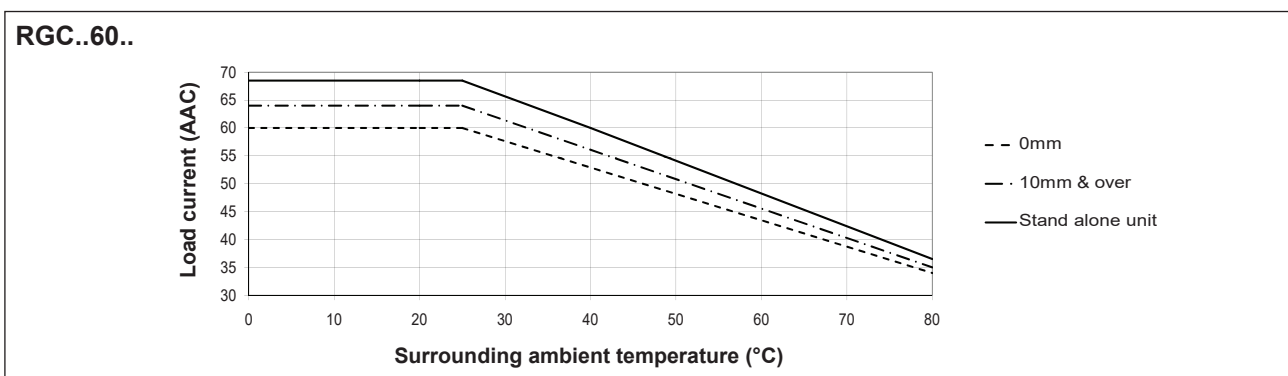
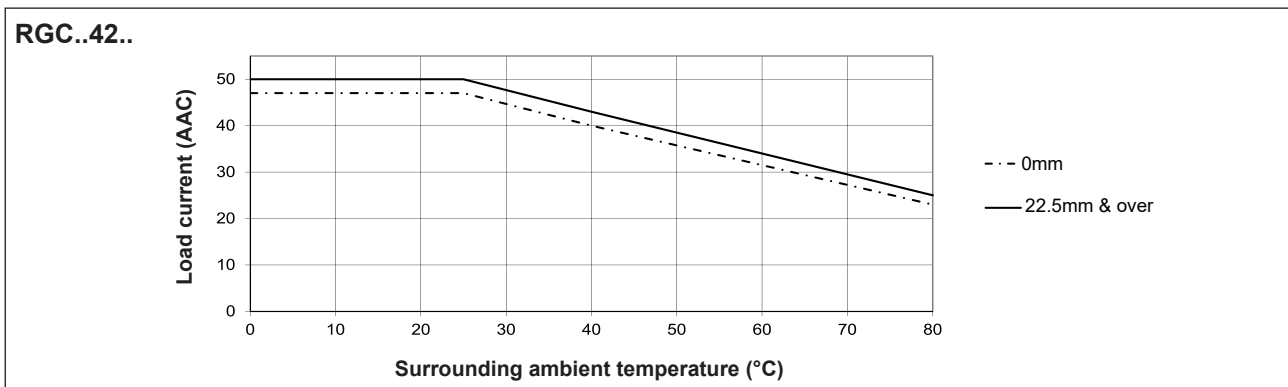
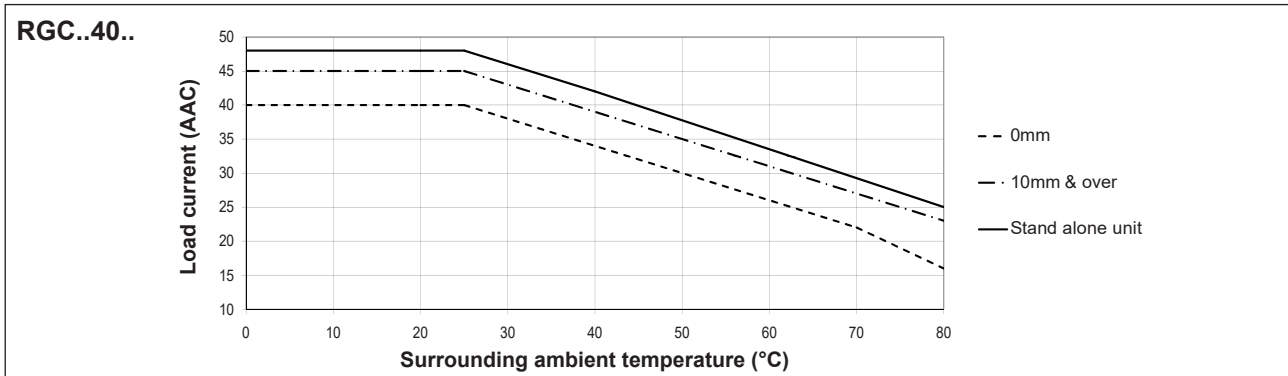

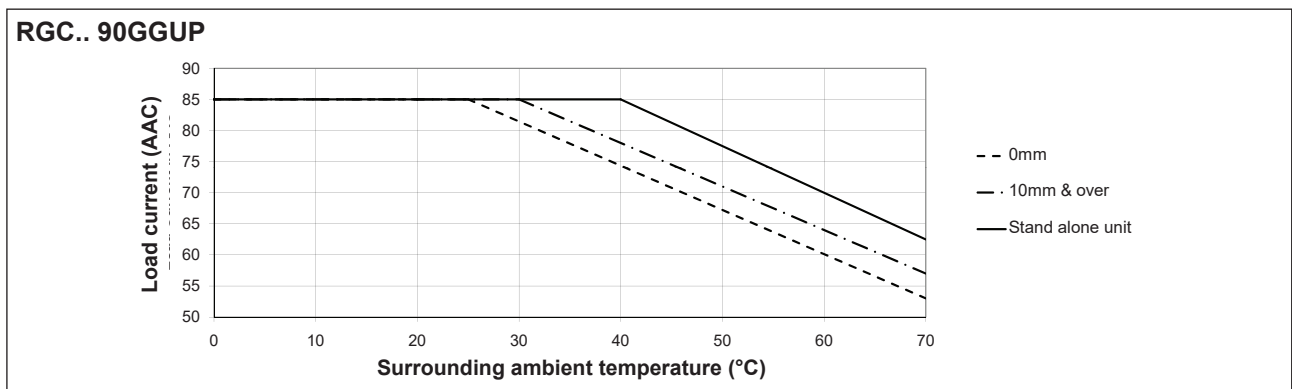

▶ Derating vs. Spacing curves



Derating vs. Spacing curves



Compatibility and conformance

| | |
|--|--|
| Approvals |       |
| Standards compliance | LVD: EN/IEC 60947-4-2, EN/IEC 60947-4-3 EMCD: EN/IEC 60947-4-3 EE: EN 60947-4-3 EMC: EN 60947-4-3 UL: UL508 (E172877), NMFT cUL: C22.2 No. 14 (E172877), NMFT7 VDE: VDE0660-109 GL |
| UL short circuit current rating | 100k Arms (refer to short circuit current section, Type 1 – UL508) |

7. Germanischer Lloyd approval applicable only to models RGC..15, RGC..20, RGC..25 and RGC..30

| Electromagnetic compatibility (EMC) - Immunity | |
|--|--|
| Electrostatic discharge (ESD) | EN/IEC 61000-4-2 8 kV air discharge, 4 kV contact (PC1) |
| Radiated radio frequency | EN/IEC 61000-4-3 10 V/m, from 80 MHz to 1 GHz (PC1) 10 V/m, from 1.4 to 2 GHz (PC1) 10 V/m, from 2 to 2.7 GHz (PC1) |
| Electrical fast transient (burst) | EN/IEC 61000-4-4 Output: 2 kV, 5 kHz (PC1) Input: 1 kV, 5 kHz (PC1) |
| Conducted radio frequency | EN/IEC 61000-4-6 10 V/m, from 0.15 to 80 MHz (PC1) |
| Electrical surge | EN/IEC 61000-4-5 Output, line to line: 1 kV (PC1) Output, line to earth: 2 kV (PC1) Input, line to line, 1kV (PC2) Input, line to earth, 2kV (PC2) RGC..P DC lines, line to line, 500V (PC2) RGC..P DC lines, line to earth, 500V (PC2) RGC..P Signal lines, line to earth, 1kV (PC2) |
| Voltage dips | EN/IEC 61000-4-11 0% for 0.5, 1 cycle (PC2) 40% for 10 cycles (PC2) 70% for 25 cycles (PC2) 80% for 250 cycles (PC2) |
| Voltage interruptions | EN/IEC 61000-4-11 0% for 5000 ms (PC2) |

| Electromagnetic compatibility (EMC) - Emissions | |
|--|--|
| Radio interference field emission (radiated) | EN/IEC 55011 Class A: from 30 to 1000 MHz |
| Radio interference voltage emissions (conducted) | EN/IEC 55011 Class A: from 0.15 to 30 MHz (External filter may be required - refer to Filtering section) |

Additional conformance to railway standards

| | |
|---|---|
| Applicable to variants | RGC.. |
| Additional conformance specific to railway applications | EN 50155 EN 45545-2 EN 50121-3-2 |
| Hazardous level conformance according to EN 45545-2 | HL1, HL2 for requirement R23 HL1 for requirement R22 |
| Operating temperature class according to EN 50155 | OT3 (-25 °C to +70 °C) |
| Vibration and shock | EN 61373 Category 1, Class B |
| Additional EMC conformance | according to EN 50121-3-2 |
| Radiated radio frequency immunity | EN/IEC 61000-4-3 20 V/m, from 80 MHz to 1 GHz (PC1) 10 V/m, from 1.4 to 2 GHz (PC1) 5 V/m, from 2 to 2.7 GHz (PC1) 3 V/m, 5.1 - 6 GHz (PC1) |
| Power quality measurement | EN/IEC 61000-4-30 50 Hz - 2 kHz, <8% THD (PASS) |

Filter connection diagram

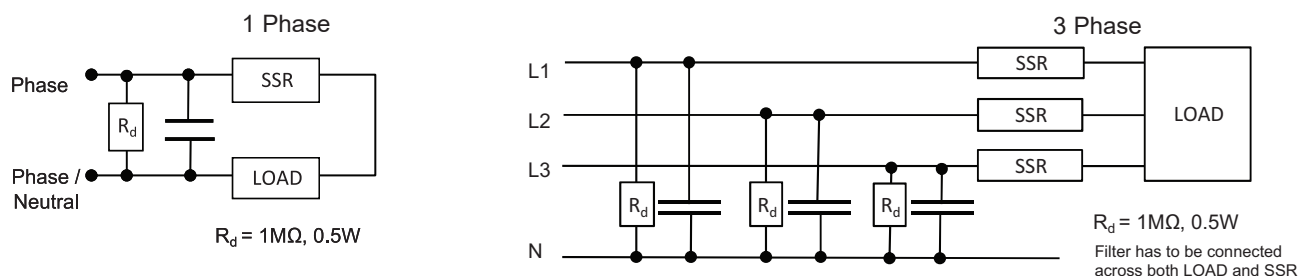

Filtering

| Part number | Suggested filter for EN 55011 Class A compliance | Maximum heater current [AAC] |
|--|--|------------------------------|
| RGC1A23..15 | 68nF / 275 V / X1 | 20 AAC |
| RGC1A23..20 | 68nF / 275 V / X1 | 20 AAC |
| RGC1A23..25, RGC1A23..30 | 220 nF / 275V / X1 | 30 AAC |
| RGC1A60..15 | 100 nF / 760V / X1 | 20 AAC |
| RGC1A60..20 | 100 nF / 760V / X1 | 20 AAC |
| RGC1A60..25, RGC1A60..30 | 220 nF / 760V / X1 | 30 AAC |
| RGC1A60..40 | 220 nF / 760V / X1 330 nF / 760V / X1 | 25 AAC 45 AAC |
| RGC1A60..60 | 220 nF / 760V / X1 330 nF / 760V / X1 | 25 AAC 45 AAC |
| RGC1A60..42, RGC1A60..62, RGC1A60..90 | 330 nF / 760V / X1 680 nF / 760V / X1 | 40 AAC 65 AAC |

Note:

- Control input lines must be installed together to maintain products' susceptibility to Radio Frequency interference.
- Use of AC solid state relays may, according to the application and the load current, cause conducted radio interferences. Use of mains filters may be necessary for cases where the user must meet E.M.C requirements. The capacitor values given inside the filtering specification tables should be taken only as indications, the filter attenuation will depend on the final application.
- This product has been designed for Class A equipment. Use of this product in domestic environments may cause radio interference, in which case the user may be required to employ additional mitigation methods.
- Performance Criteria 1 (PC1): No degradation of performance or loss of function is allowed when the product is operated as intended.
- Performance Criteria 2 (PC2): During the test, degradation of performance or partial loss of function is allowed. However when the test is complete the product should return operating as intended by itself.
- Performance Criteria 3 (PC3): Temporary loss of function is allowed, provided the function can be restored by manual operation of the controls.

Environmental specifications

| | |
|--|---|
| Operating temperature RGC..P | -40°C to +80°C (-40°F to +176°F) -30°C to +70°C (-22°F to +158°F) |
| Storage temperature | -40 to +100°C (-40 to +212 °F) |
| Relative humidity | 95% non-condensing @ 40°C |
| Pollution degree | 2 |
| Installation altitude | 0-1000 m. Above 1000 m derate linearly by 1% of FLC per 100 m up to a maximum of 2000 m |
| Vibration resistance | 2g / axis (2-100Hz, IEC 60068-2-6, EN 50155, EN 61373) |
| Impact resistance | 15/11 g/ms (EN50155, EN61373) |
| EU RoHS compliant | Yes |
| China RoHS |  |

The declaration in this section is prepared in compliance with People's Republic of China Electronic Industry Standard SJ/T11364-2014: Marking for the Restricted Use of Hazardous Substances in Electronic and Electrical Products.

| Part Name | Toxic or Harardous Substances and Elements | | | | | |
|----------------------------|--|--------------|--------------|------------------------------|--------------------------------|---------------------------------------|
| | Lead (Pb) | Mercury (Hg) | Cadmium (Cd) | Hexavalent Chromium (Cr(VI)) | Polybrominated biphenyls (PBB) | Polybrominated diphenyl ethers (PBDE) |
| Power Unit Assembly | x | o | o | o | o | o |

O: Indicates that said hazardous substance contained in homogeneous materials for this part are below the limit requirement of GB/T 26572.

X: Indicates that said hazardous substance contained in one of the homogeneous materials used for this part is above the limit requirement of GB/T 26572.

这份申明根据中华人民共和国电子工业标准
SJ/T11364-2014：标注在电子电气产品中限定使用的有害物质

| 零件名称 | 有毒或有害物质与元素 | | | | | |
|------|------------|--------|--------|--------------|-------------|--------------|
| | 铅 (Pb) | 汞 (Hg) | 镉 (Cd) | 六价铬 (Cr(VI)) | 多溴化联苯 (PBB) | 多溴联苯醚 (PBDE) |
| 功率单元 | x | o | o | o | o | o |

O:此零件所有材料中含有的该有害物低于GB/T 26572的限定。

X: 此零件某种材料中含有的该有害物高于GB/T 26572的限定。

Short circuit protection

Protection Co-ordination, Type 1 vs Type 2:

Type 1 protection implies that after a short circuit, the device under test will no longer be in a functioning state. In Type 2 co-ordination the device under test will still be functional after the short circuit. In both cases, however the short circuit has to be interrupted. The fuse between enclosure and supply shall not open. The door or cover of the enclosure shall not be blown open. There shall be no damage to conductors or terminals and the conductors shall not separate from terminals. there shall be no breakage or cracking of insulating bases to the extent that the integrity of the mounting of live parts is impaired. Discharge of parts or any risk of fire shall not occur.

The product variants listed in the table hereunder are suitable for use on a circuit capable of delivering not more than 100,000 Arms Symmetrical Amperes, 600 Volts maximum when protected by fuses. Tests at 100,000 A were performed with Class J fuses, fast acting; please refer to the table below for maximum allowed ampere rating of the fuse. Use fuses only.

Tests with Class J fuses are representative of Class CC fuses.

| Protection co-ordination Type 1 according to UL 508 | | | | |
|---|---|-------------------|---------|---------------|
| Part No. | Prospective short circuit current [kArms] | Max fuse size [A] | Class | Voltage [VAC] |
| RGC..15 | 100 | 10 | J | Max. 600 |
| | | 15 | CC | |
| RGC..20 | | 10 | J | |
| | | 15 | CC | |
| RGC..25 | | 30 | J or CC | |
| RGC..30 | | 30 | J or CC | |
| RGC..40 | | 40 | J | |
| RGC..42 | | 90 | J | |
| RGC..60 | | 40 | J | |
| RGC..62 | | 90 | J | |
| RGC..90 | | 40 | J | |

| Protection co-ordination Type 2 (IEC/EN 60947-4-2/ -4-3) | | | | | | |
|--|---|-------------------------|-------------------------|-------------------|---------------|--------------------|
| Part No. | Prospective short circuit current [kArms] | Ferraz Shawmut (Mersen) | | Siba | | Max. voltage [VAC] |
| | | Max fuse size [A] | Part number | Max fuse size [A] | Part number | |
| RGC..15 | 10 | 25 | 6.9xx CP GRC 14x51 /25 | 32 | 50 142 06.32 | 600 |
| | 100 | | | | | |
| RGC..20 | 10 | 40 | 6.6xx CP URD 22x58 /40 | 32 | 50 142 06.32 | 600 |
| | 100 | | | | | |
| RGC..25 | 10 | 40 | 6.6xx CP URD 22x58 /40 | 32 | 50 142 06.32 | 600 |
| | 100 | | | | | |
| RGC..30 | 10 | 40 | 6.9xx CP GRC 22x58 /40 | 32 | 50 142 06.32 | 600 |
| | 100 | | | | | |
| RGC..40 | 10 | 63 | 6.621 CP URGD 27x60 /63 | 63 | 50 194 20.63 | 600 |
| | | 70 | A70QS70-4 | | | |
| | 100 | 63 | 6.621 CP URQ 27x60 /63 | | | |
| RGC..42 | 10 | 70 | A70QS70-4 | 80 | 50 194 20.80 | 600 |
| | | 63 | 6.9xx CP URC 14x51 /63 | | | |
| | 70 | | A70QS70-4 | | | |
| RGC..60 up to 65AAC | 10 | 80 | 6.621 CP URQ 27x60 /80 | 80 | 50 194 20.80 | 600 |
| | 100 | - | - | | | |
| RGC..62 | 10 | 100 | 6.9xx CP GRC 22x58 /100 | 100 | 50 194 20.100 | 600 |
| | | | A70QS100-4 | | | |
| | 6.621 CP URGD 27x60 /100 | | | | | |
| | A70QS100-4 | | | | | |
| RGC..90 up to 80AAC | 10 | 100 | 6.621 CP URQ 27x60 /100 | 100 | 50 194 20.100 | 600 |
| | | | A70QS100-4 | | | |
| | 100 | | - | | | |

xx = 00, without fuse trip indication, xx= 21, with fuse trip indication

| Protection co-ordination Type 2 with Miniature Circuit Breakers (M.C.B.s) | | | | |
|---|---|---|--|--|
| Solid State Relay type | ABB Model no. for Z - type M. C. B. (rated current) | ABB Model no. for B - type M. C. B. (rated current) | Wire cross sectional area [mm ²] | Minimum length of Cu wire conductor [m] ^a |
| RGC..15 RGC..20 (525 A ² s) | S201 - Z4 (4A) | S201 - B2 (2A) | 1.0 | 21.0 |
| | S201 - Z6 UC (6A) | S201 - B2 (2A) | 1.0 | 21.0 |
| | | | 1.5 | 31.5 |
| RGC..25 RGC..30 (1800 A ² s) | S201 - Z10 (10A) | S201-B4 (4A) | 1.0 | 7.6 |
| | | | 1.5 | 11.4 |
| | | | 2.5 | 19.0 |
| | S201 - Z16 (16A) | S201-B6 (6A) | 1.0 | 5.2 |
| | | | 1.5 | 7.8 |
| | | | 2.5 | 13.0 |
| | | | 4.0 | 20.8 |
| | S201 - Z20 (20A) | S201-B10 (10A) | 1.5 | 12.6 |
| | | | 2.5 | 21.0 |
| | S201 - Z25 (25A) | S201-B13 (13A) | 2.5 | 25.0 |
| 4.0 | | | 40.0 | |
| S202 - Z25 (25A) | S202-B13 (13A) | 2.5 | 19.0 | |
| | | 4.0 | 30.4 | |
| RGC..40 (3200 A ² s) | S201 - Z25 (25A) | S201 - B13 (13A) | 2.5 | 7.0 |
| | | | 4.0 | 11.2 |
| | | | 6.0 | 16.8 |
| RGC..60 (3200 A ² s) | S201 - Z25 (25) | S201 - B13 (13A) | 2.5 | 7.0 |
| | | | 4.0 | 11.2 |
| | | | 6.0 | 16.8 |
| RGC..90GGUP (6600 A ² s) | S201 - Z20 (20A) | S201-B10 (10A) | 1.5 | 4.2 |
| | | | 2.5 | 7.0 |
| | | | 4.0 | 11.2 |
| | S201 - Z32 (32A) | S201-B16 (16A) | 2.5 | 13.0 |
| | | | 4.0 | 20.8 |
| | | | 6.0 | 31.2 |
| | S202 - Z20 (20A) | S202-B10 (10A) | 1.5 | 1.8 |
| | | | 2.5 | 3.0 |
| | | | 4.0 | 4.8 |
| | S202 - Z32 (32A) | S202-B16 (16A) | 2.5 | 5.0 |
| 4.0 | | | 8.0 | |
| 6.0 | | | 12.0 | |
| 10.0 | | | 20.0 | |
| S202 - Z50 (50A) | S202-B25 (25A) | 4.0 | 14.8 | |
| | | 6.0 | 22.2 | |
| | | 10.0 | 37.0 | |
| RGC..42 RGC..62 (18000 A ² s) | S201-Z32 (32A) | S201-B16 (16A) | 2.5 | 3.0 |
| | | | 4.0 | 4.8 |
| | | | 6.0 | 7.2 |
| | S201-Z50 (50A) | S201-B25 (25A) | 4.0 | 4.8 |
| | | | 6.0 | 7.2 |
| | | | 10.0 | 12.0 |
| | | | 16.0 | 19.2 |
| | S201-Z63 (63A) | S201-B32 (32A) | 6.0 | 7.2 |
| | | | 10.0 | 12.0 |
| 16.0 | | | 19.2 | |

8. Between MCB and Load (including return path which goes back to the mains)

Note: A prospective current of 6 kA and a 230 / 400 V power supply is assumed for the above suggested specifications. For cables with different cross section than those mentioned above please consult Carlo Gavazzi's Technical Support Group.

S201 models refer to 1-pole M.C.B., S202 models refer to 2-poles M.C.B.

Over temperature alarm procedure and fan operation for versions with integrated fan

ALARM Signal and Fan
(applicable to RGC..D90GGUP)

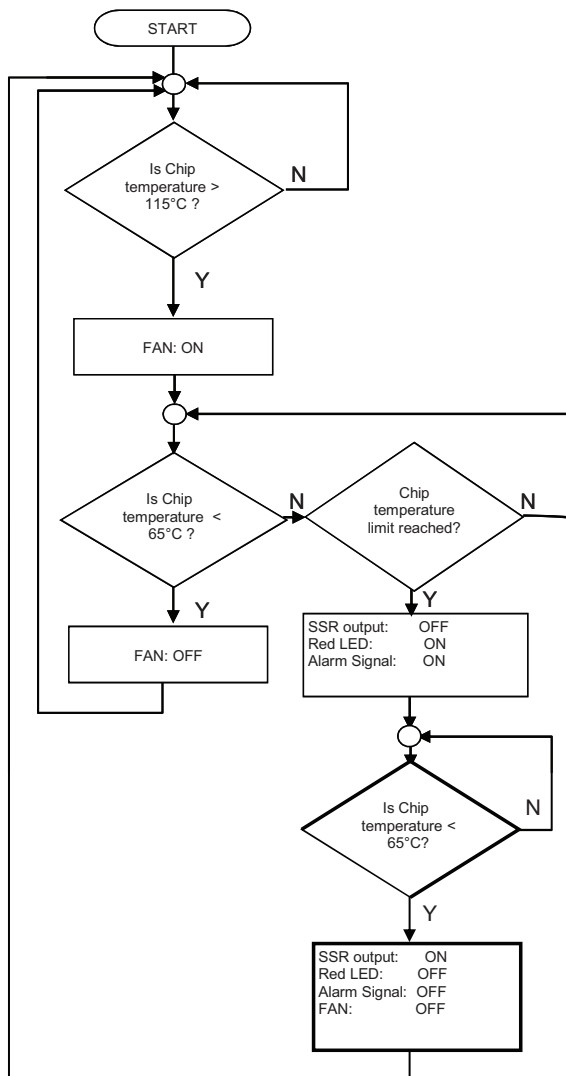

ALARM Signal only

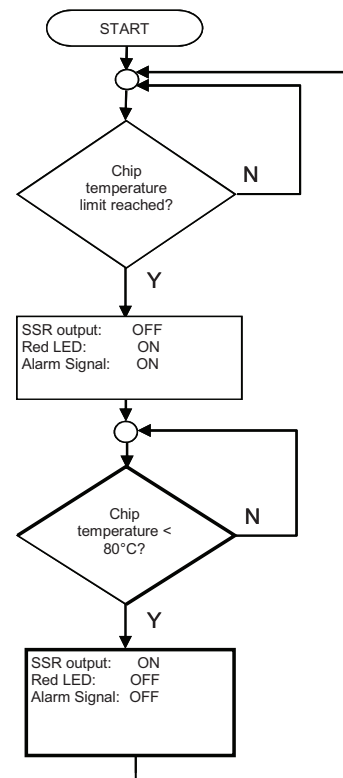

CAUTION

- Alarm condition resets whenever the voltage signal is removed from terminal A1 (+)
- In the case of RGC1A60D90GGUP, if the voltage signal is not applied across A1(+) and A2 (-) terminals, the overtemperature detection and functionality is lost (including fan operation and alarm signalling)
- In the case of RGC1A60A90GGUP it is necessary to supply IN2 and IN3 with 24VDC for fan operation.
- Alarm procedure for RGC1A60A90GGUP follows 'Alarm signal only' flow since fan is continuously operating.
- Alarm condition automatically resets ONLY when power semiconductor temperature < 80 °C
- Temperatures indicated are typical figures.

Dimensions

RGC..15KGU, RGC..25KGU

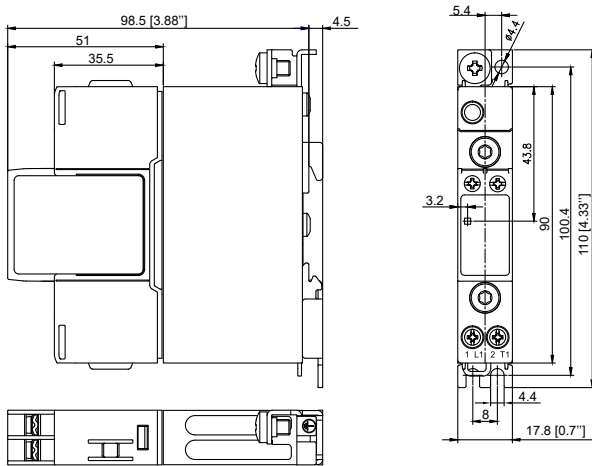

RGC..20KGU

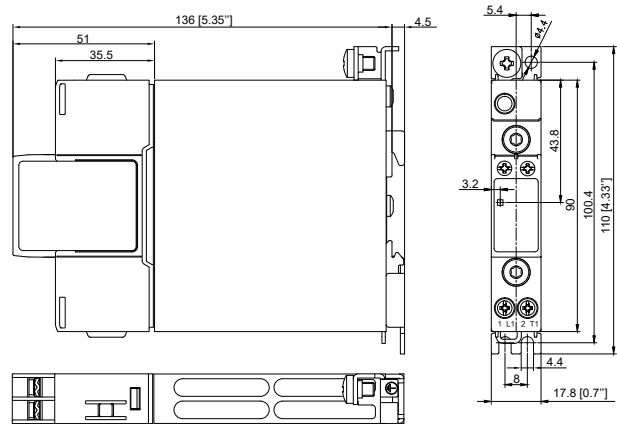

RGC..30KGU

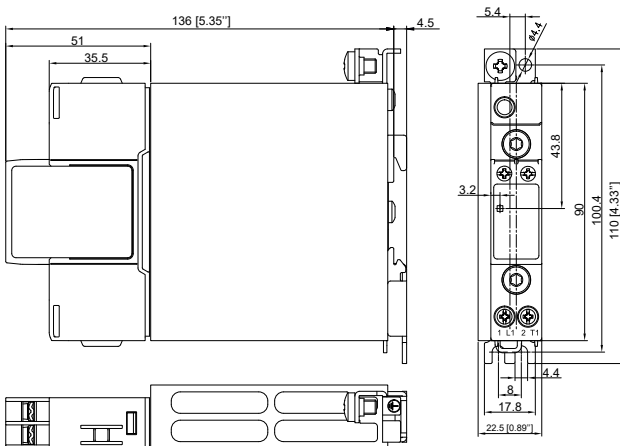

RGC..40KGU, RGC..42KGU

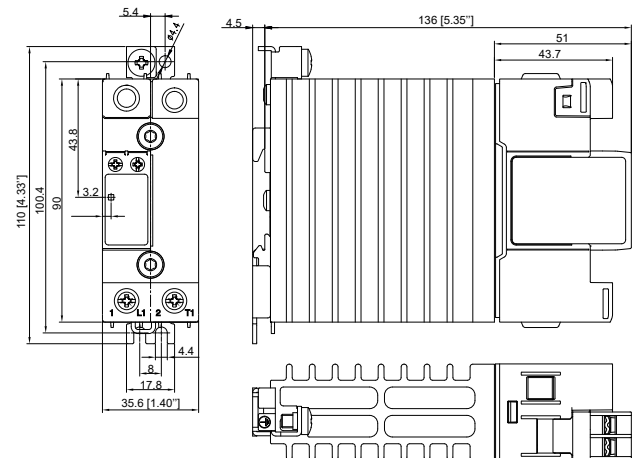

RGC..60KGU, RGC..62KGU

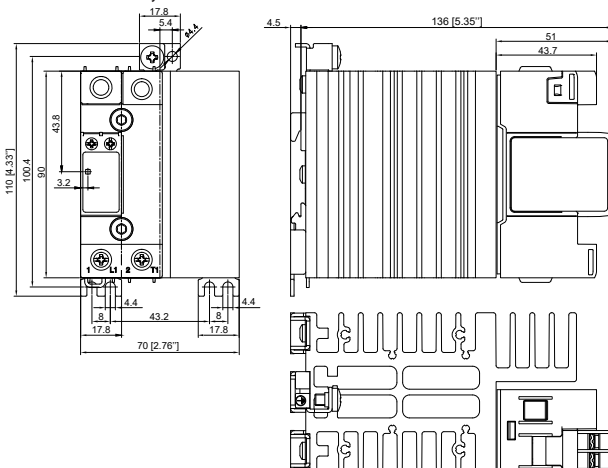

Housing width tolerance +0.5mm, -0mm as per DIN 43880. All other tolerances +/- 0.5mm. Dimensions in mm.

Dimensions - Over Temperature Protection

RGC...40GGUP

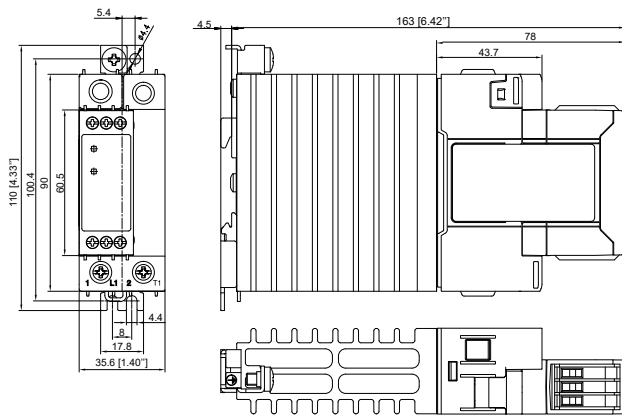

RGC...60GGUP

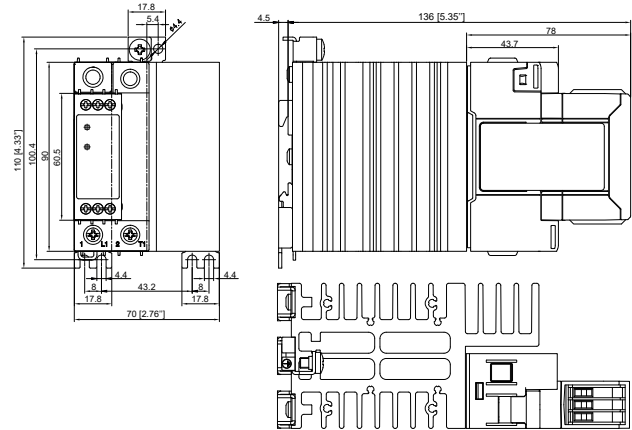

RGC...90GGUP

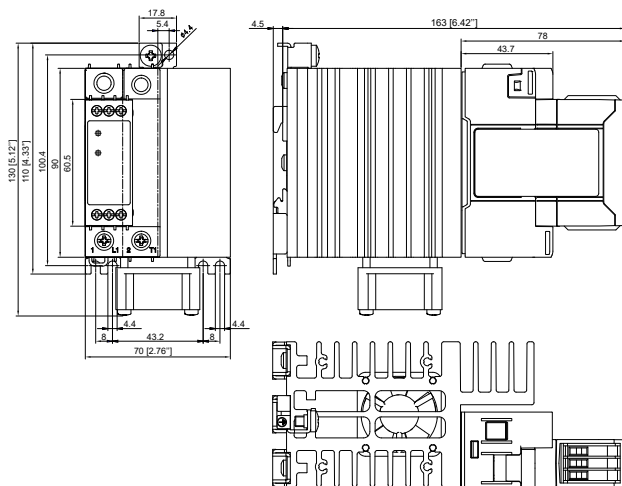

Housing width tolerance +0.5mm, -0mm as per DIN 43880. All other tolerances +/- 0.5mm. Dimensions in mm.

Terminal layout

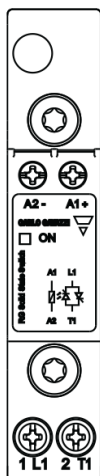

RGC..15KGU, RGC..20KGU,
RGC..25KGU, RGC..30KGU

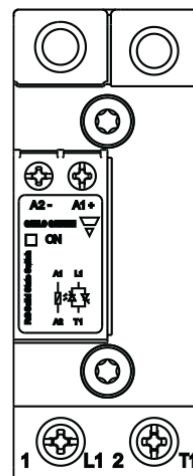

RGC..40KGU, RGC..42KGU,
RGC..60KGU, RGC..62KGU

- 1/L1: Mains supply connection
- 2/T1: Load connection
- A1(+): Positive control signal
- A2(-): Control ground
- ⊕: Protective Earth

Terminal layout - Over Temperature Protection

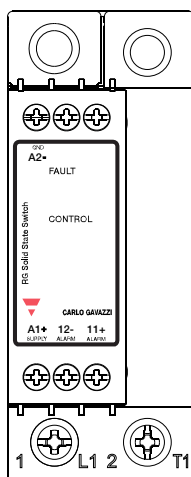

RGC...40GGUP
RGC...60GGUP

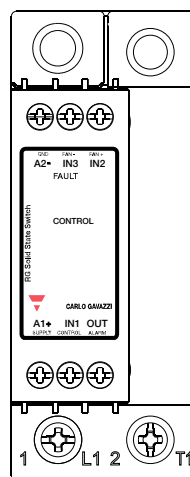

RGC...D90GGUP

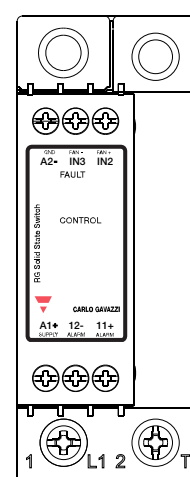

RGC...A90GGUP

- 1/L1: Mains supply connection
- 2/T1: Load connection
- A1(+): Positive control signal, Positive supply voltage in case of RGC1A60D90GGUP
- A2 (-): Control ground
- IN1: Control signal (only for RGC1A60D90GGUP)
- IN2: Fan +supply (only for RGC1A60A90GGUP)
- IN3: Fan -supply (only for RGC1A60A90GGUP)
- 11+ : Alarm output (+)
- OUT, 12 - : Alarm output (-), OUT
- ⊕: Protective earth

Connection diagram

Variant without Over Temperature Protection

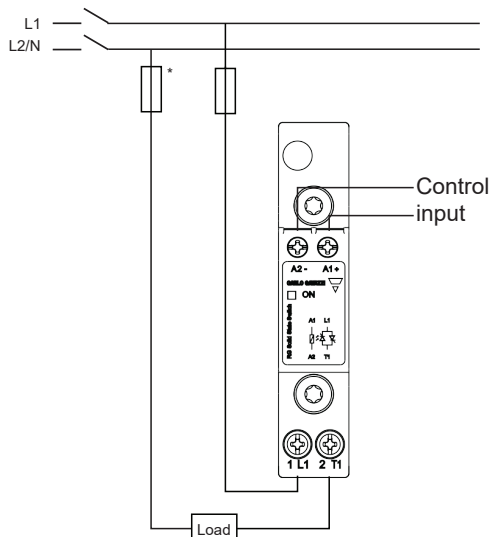

Variant with Over Temperature Protection

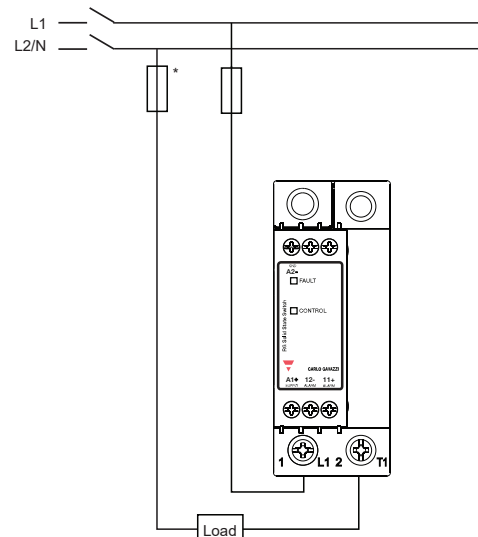

* depends on system requirements

Connection diagram - Auxiliary connections for Over Temperature Protection variants

DC Control
RGC1..D4xGGUP
RGC1..D6xGGUP

Uc: 5 - 32 VDC
Ua: max 35VDC
Alarm Output: max. 50mA

A1, A2: Control voltage
11, 12: Alarm output

RGC1..D90GGUP

Uc: 5 - 32 VDC
Us: 24 VDC
Alarm Output: max. 50mA
Note: Fan is internally supplied

A1, A2: Supply voltage
IN1: Control voltage
OUT: Alarm output

AC Control
RGC1..A4xGGUP
RGC1..A6xGGUP

Uc: 24 - 275 VAC
24 - 190 VDC
Ua: max 35VDC
Alarm Output: max. 50mA

A1, A2: Control voltage
11, 12: Alarm output

RGC1..A90GGUP

Uc: 24 - 275 VAC
24 - 190 VDC
Ua: max. 35 VDC
Alarm Output: max. 50mA
Uf: 24 VDC (needs to be supplied externally)

A1, A2: Control voltage
11, 12: Alarm output
IN2, IN3: Fan supply

Functional diagram

DC control

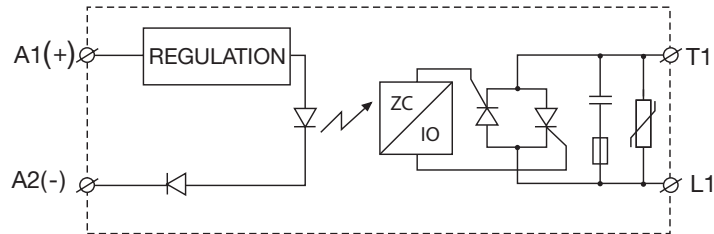

AC control

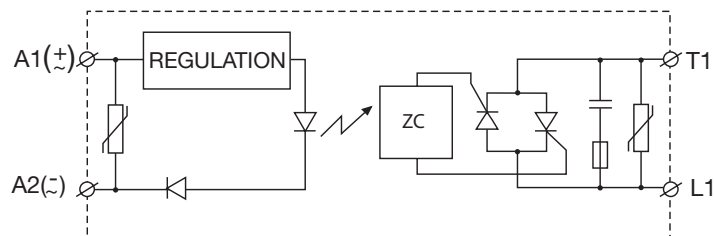

Installation

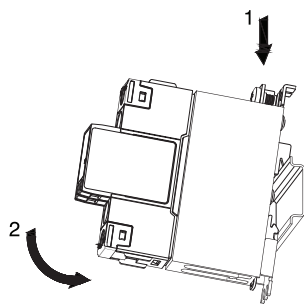

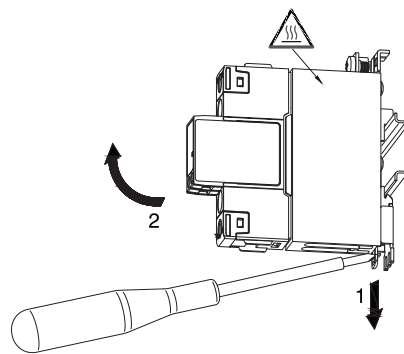

Mounting on DIN rail



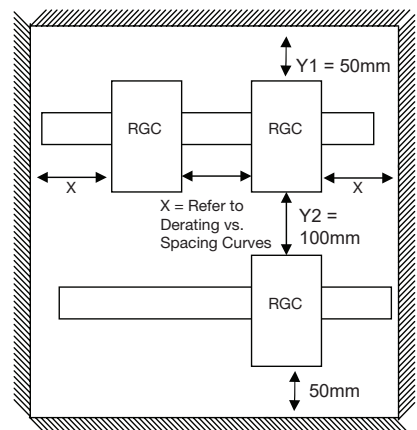

Dismounting from DIN rail

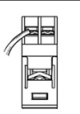
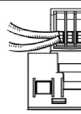
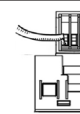

Connection Specifications

| Power connections | | |
|---|--|---|
| Terminals | 1/L1, 2/T1 | |
| Conductors | Use 75°C copper (Cu) conductors | |
| | RGC...KGU (RG..15, 20, 25, 30) | RGC..KGU, RGC...GGUP (RG..40, 42, 60, 62, 90) |
| |  |  |
| Connection type | M3.5 screw with box clamp | M5 screw with box clamp |
| Stripping length | 12 mm | 11 mm |
| Rigid (solid & stranded) UL/cUL rated data | 1x 1.0 – 6.0 mm ² 1x 18 – 10 AWG | 1x 2.5 – 25.0 mm ² 1x 14 – 3 AWG |
| Flexible with end sleeve | 1x 0.5 – 2.5 mm ² 1x 20 – 2.5 mm ² | 1x 2.5 – 16.0 mm ² 1x 14 – 6 AWG |
| Flexible without end sleeve | 1x 1 – 4 mm ² 1x 18 – 12 mm ² | 1x 4.0 – 25.0 mm ² 1x 12 – 3 AWG |
| Torque specifications | Posidrive bit 1 UL: 1.0 Nm (8.85 lb-in) IEC: 0.9 - 1.1Nm (8 - 9.7 lb-in) | Posidrive bit 2 UL: 2.5 Nm (22 lb-in) IEC: 2.5 – 3.0 Nm (22 – 26.6 lb-in) |
| Protective Earth (PE) connection | M5, 1.5 Nm (13.3 lb-in) M5 PE screw is not provided with the solid state relay. PE connection is required when product is intended to be used in Class 1 applications according to EN/IEC 61140 | |

| Control connections | | | | |
|---|---|---|---|---|
| Terminals | A1+, A2- | | A1+, A2-, IN1, IN2, IN3, 11+, 12-, OUT | |
| Conductors | Use 60/75°C copper (Cu) conductors | | | |
| | RG..KGU screw control terminal | | RG..GGUP | |
| |  |  |  |  |
| Connection type | M3 screw with captivated washer | | M3 screw with box clamp | |
| Stripping length | 8 mm | | 6 mm | |
| Rigid (solid & stranded) UL/cUL rated data | 2x 0.5 - 2.5 mm ² 2x 18 - 12 AWG | 1x 0.5 - 2.5 mm ² 1x 18 - 12 AWG | 2x 1.0 - 2.5 mm ² 2x 18 - 14 AWG | 1x 1.0 - 2.5 mm ² 1x 18 - 14 AWG |
| Flexible with end sleeve | 2x 0.5 - 2.5 mm ² 2x 18 - 12 AWG | 1x 0.5 - 2.5 mm ² 1x 18 - 12 AWG | 2x 1.0 - 2.5 mm ² 2x 18 - 14 AWG | 1x 1.0 - 2.5 mm ² 1x 18 - 14 AWG |
| Torque specification | Posidrive 1 UL: 0.5 Nm (4.4 lb-in), IEC: 0.5-0.6 Nm (4.4-5.3 lb-in) | | M3, Pozidriv 1 UL: 0.5 Nm (4.4 lb-in) IEC: 0.4 - 0.5Nm (3.5 - 4.4lb-in) | |

 **Bulk packaging option**

- Packing qty.: 20 pcs.
- Total weight : 4.75 kg

Applicable only to RGC..15 and RGC..25 models



COPYRIGHT ©2022
Content subject to change.
Download the PDF: <https://gavazziautomation.com>