

ARTESYN DA45C SERIES

External Power Adapter
USB PD 3.0



PRODUCT DESCRIPTION

Advanced Energy's Artesyn new standard 45W USB PD 3.0 Type-C charging adapter provides small-size, high efficiency and rapid charging features. It complies with USB-PD 3.0 charging technology and meets new European CoC v5 Tier 2 and US DoE Level VI energy saving requirements.

The highly integrated features chip topology provides simplified & compact design. It meets extremely low standby power (< 75mW at 5Vdc) and high average loading efficiency (> 88% at 20Vdc) requirements. The enclosure temperature rise is less than 45 °C in 0 to 40 °C full operating temperature range.

Additional features include over-voltage, over-current, short-circuit and over-temperature protections.

AT A GLANCE

Total Power

45 Watts

Input Voltage

90 to 264 Vac

of Outputs

Single



SPECIAL FEATURES

- Small Size 58 x 40.2 x 27 mm Excluding AC Pins
- Input Range 90-264 Vac
- High Average Loading Efficiency 88% min. @ 20Vdc
- USB Type C Connector Output
- 2-Pin Input Class II
- Operating Temperature Range 0 °C to +40 °C
- Reinforced Insulation 3000 Vac
- Over Voltage Protection
- Over Temperature Protection
- Over Current Protection
- Elegant Enclosure ID Design
- USB-PD 3.0 Technology Compliant

- European CoC v5 T2 & US DoE VI Compliant
- EN62368-1 Safety Standard
- One Year Warranty

SAFETY

- cUL/UL 62368-1
- IEC/EN 62368-1
- CCC
- CE
- PSE
- FCC
- NRCAN

MODEL NUMBERS

Standard	Ordering / Safety Model Number	Input Voltage Range	Output Voltage Level ¹	Maximum Load
DA45C-J3WUS	700-014340-0000	90-264Vac	5V	3.0A
			9V	3.0A
			15V	3.0A
			20V	2.25A
DA45C-J3WCH	700-014340-0100	90-264Vac	5V	3.0A
			9V	3.0A
			15V	3.0A
			20V	2.25A
DA45C-J3WEU	700-014340-0200	90-264Vac	5V	3.0A
			9V	3.0A
			15V	3.0A
			20V	2.25A

Note 1 - The DA45C series complies with USB-PD 3.0. It will shift to different output voltage levels according to different loading devices.

Options

AC Plug Configuration for Fixed Plug	
U.S. 2-prong	DA45C-J3WUS
China 2-prong	DA45C-J3WCH
Europe 2-prong	DA45C-J3WEU



ELECTRICAL SPECIFICATIONS

Absolute Maximum Ratings

Stress in excess of those listed in the “Absolute Maximum Ratings” may cause permanent damage to the power supply. These are stress ratings only and functional operation of the unit is not implied at these or any other conditions above those given in the operational sections of this TRN. Exposure to any absolute maximum rated condition for extended periods may adversely affect the power supply’s reliability.

Table 1. Absolute Maximum Ratings						
Parameter	Model	Symbol	Min	Typ	Max	Unit
Input Voltage AC continuous operation	All models	$V_{IN,AC}$	90	-	264	Vac
Maximum Output Power	All models	$P_{O,max}$	-	-	45	W
Insulation Resistance 500Vdc / 90% RH	All models		100	-	-	Mohm
Isolation Voltage Input to output	All models		3000	-	-	Vac
Ambient Operating Temperature	All models	T_A	0	-	+40	°C
Storage Temperature	All models	T_{STG}	-40	-	+85	°C
Humidity (non-condensing)	All models		5	-	95	%

ELECTRICAL SPECIFICATIONS

Input Specifications

Table 2. Input Specifications						
Parameter	Condition	Symbol	Min	Typ	Max	Unit
Operating Input Voltage, AC	All	$V_{IN,AC}$	90	-	264	Vac
Input AC Frequency	All	f_{IN}	47	50 / 60	63	Hz
Input Surge Voltage	$V_{IN,AC} = 264\text{Vac}$ to 300Vac (100mS, max) and back to 264Vac	$V_{IN,surge}$	-	-	300	Vac
Inrush Current	Discharge from E-cap. (Pre-charged by 264Vac line)	No Damage				
Brown-out / Recovery	Start decreasing at 90Vac	No Damage				
Maximum Input Current	$V_{IN,AC} = 90\text{Vac} / 60\text{Hz}$ $V_O = 20\text{Vdc}$ $I_O = 2.25\text{A}$	$I_{IN,max}$	-	-	1220	mA
No Load Input Power ($V_O = \text{On}$, $I_O = 0\text{A}$)	$V_{IN,AC} = 230 / 115\text{Vac}$ Output Unplugged	$P_{IN,standby}$	-	-	75	mW
Efficiency -10% Load	$V_{IN,AC} = 230\text{Vac}$ $V_O = 5\text{Vdc}$, $I_O = 0.3\text{A}$ $V_O = 9\text{Vdc}$, $I_O = 0.3\text{A}$ $V_O = 15\text{Vdc}$, $I_O = 0.3\text{A}$ $V_O = 20\text{Vdc}$, $I_O = 0.225\text{A}$	η	72.48 76.35 77.28 77.28	- - - -	- - - -	%
Average Efficiency	$V_{IN,AC} = 115 / 230 \text{ Vac}$ Average of at 25%, 50%, 75% & 100% Load $V_O = 5\text{Vdc}$ $V_O = 9\text{Vdc}$ $V_O = 15\text{Vdc}$ $V_O = 20\text{Vdc}$	η	81.84 87.30 88.85 88.85	- - - -	- - - -	%
Leakage Current	$V_{IN,AC} = 250\text{Vac} / 50\text{Hz}$	$I_{Leakage}$	-	-	100	μA

Note 1 - All parameters defined at 25 °C ambient temperature, unless other specified.

ELECTRICAL SPECIFICATIONS

Output Specifications

Table 3. Output Specifications						
Parameter	Condition	Symbol	Min	Typ	Max	Unit
Output Voltage Regulation ¹	V _O = 5Vdc V _O = 9Vdc V _O = 15Vdc V _O = 20Vdc	V _O	4.75 8.55 14.25 19.00	5.00 9.00 15.00 20.00	5.50 9.45 15.75 21.00	Vdc
Output Current	V _O = 5Vdc V _O = 9Vdc V _O = 15Vdc V _O = 20Vdc	I _O	- - - -	- - - -	3.0 3.0 3.0 2.25	A
Output Ripple, pk-pk ²	V _O = 5Vdc V _O = 9Vdc V _O = 15Vdc V _O = 20Vdc	V _O	- - - -	- - - -	500 500 600 600	mV _{PK-PK}
V _O Dynamic Response ³	Output Capacitor: 100uF 25% load change Slew rate: 0.15A/us Frequency: 100 / 1kHz	V _O	-	-	5	%
Turn-on Delay	V _O = 5Vdc	T _{ON}	-	-	4	Sec
Output Rise Time	All	T _{RISE}	-	-	40	mSec
Startup Overshoot / Undershoot	All	V _O	4.25	-	6.3	Vdc
Hold-up Time	V _{IN} = 115Vac / 60Hz Turn off at 0 °C V _O = 20Vdc, I _O = 2.25A	T _{hold-up}	10	-	-	mSec
Different Voltage Transfer	Removal of load (USB) for 9V,15V, 20V output modes		-	-	200	mSec
	Transition under any active load condition	Never transition to 0V				
Voltage Transfer Overshoot / Undershoot	5V to 9V (9V to 5V) 5V to 15V (15V to 5V) 5V to 20V (20V to 5V)		4.5 4.5 4.5	- - -	9.9 16.5 22.0	Vdc
Capacitive Hot-plug	V _O = 5Vdc, I _O = 0A/3A Output Capacitor: 100uF 25V E-cap	Output not Latched				

Note 1 - Regulation voltage is assumed to be tested at the USB output connector of the product. For CoC & DoE efficiency qualification test, it should be tested with a certified USB Type-C cable, 1.8m long.

Note 2 - Measure with a 0.1uF ceramic capacitor in parallel with a 10uF tantalum capacitor, 0 to 20MHz bandwidth.

Note 3 - Dynamic load response complies with USB-PD standard conditions. Within 275mS pre-defined settling time, the overshoot / undershoot limit can be higher by 0.5V (i.e. ±5% + ±0.5V of new set voltage).

ELECTRICAL SPECIFICATIONS

DA45C-J3WUS Performance Curves (Vo=5V)

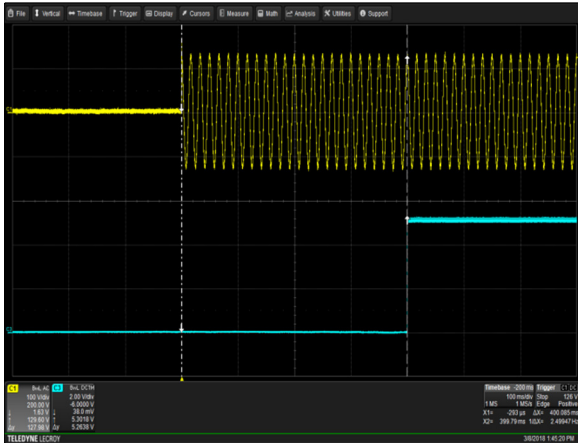

Figure 1: DA45C-J3WUS Turn-on Delay via AC mains (Vo=5V)
 Vin = 90Vac Load: Io = 3A
 Ch 1: V_{IN} Ch 3: Vo

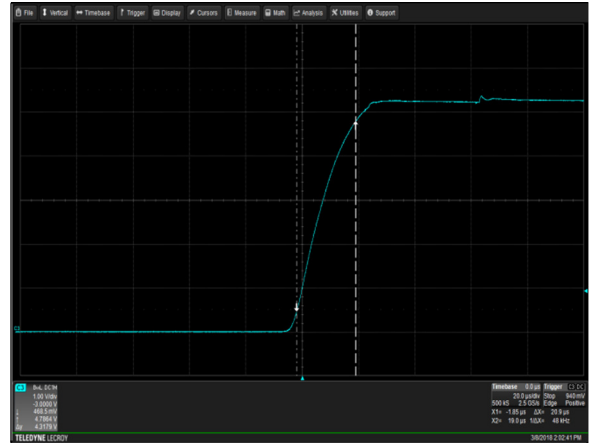

Figure 2: DA45C-J3WUS Output Voltage Startup (Vo=5V)
 Vin = 90Vac Load: Io = 3A
 Ch 1: V_{IN} Ch 3: Vo

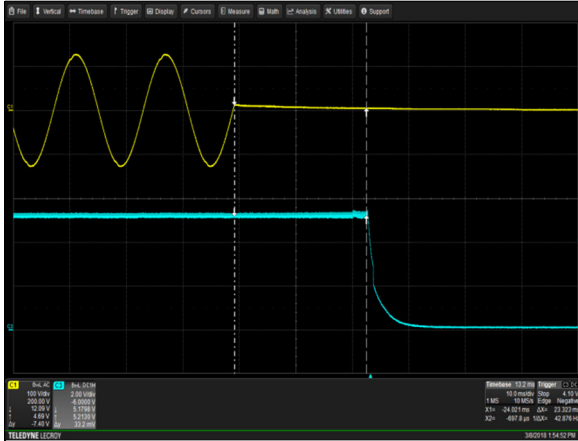

Figure 3: DA45C-J3WUS Hold-up Time (Vo=5V)
 Vin = 90Vac/63Hz/0° Load: Io = 3A
 Ch 1: V_{IN} Ch 3: Vo

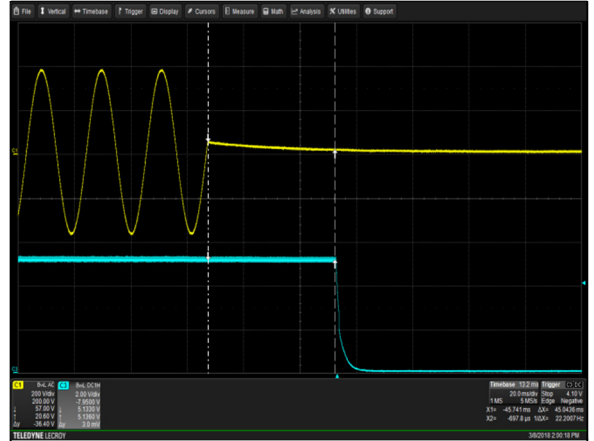

Figure 4: DA45C-J3WUS Hold-up Time (Vo=5V)
 Vin = 264Vac/47Hz/0° Load: Io = 3A
 Ch 1: V_{IN} Ch 3: Vo

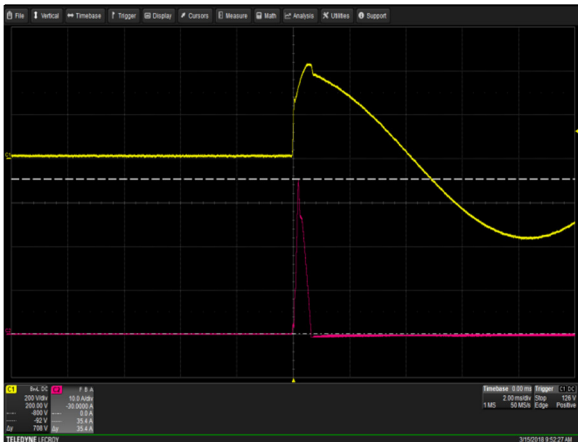

Figure 5: DA45C-J3WUS Start up Inrush Current (Vo=5V)
 Vin = 264Vac Load: Io = 0A, Turn on at 90 deg
 Ch 1: V_{IN} Ch 2: I_{IN}

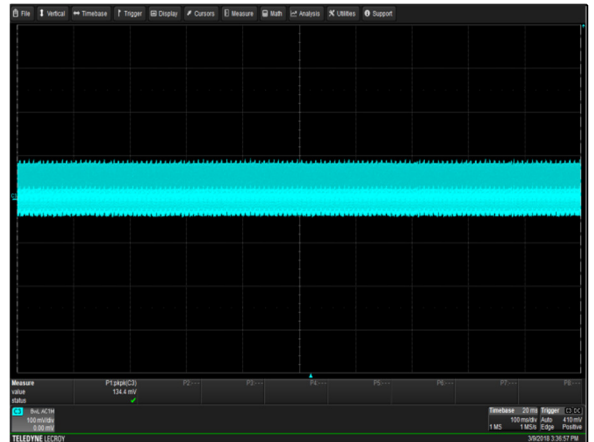

Figure 6: DA45C-J3WUS Output Ripple and Noise (Vo=5V)
 Vin = 115Vac Load: Io = 3A
 Ch 3: Vo

ELECTRICAL SPECIFICATIONS

DA45C-J3WUS Performance Curves (Vo=5V)

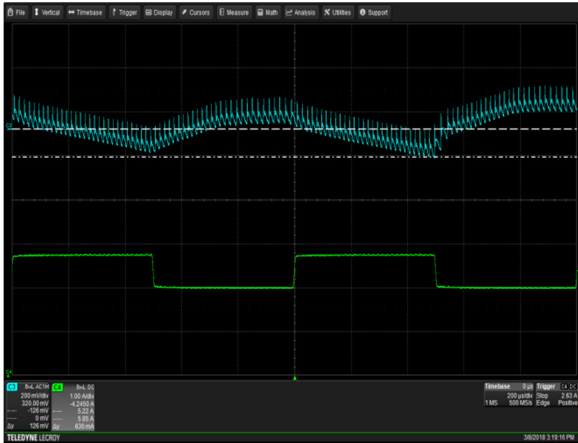

Figure 7: DA45C-J3WUS Transient Response (Vo=5V)
 Vin = 115Vac Load: Io = 75% to 100%, 0.15A/us slew rate
 Ch 3: Vo Ch 4: Io

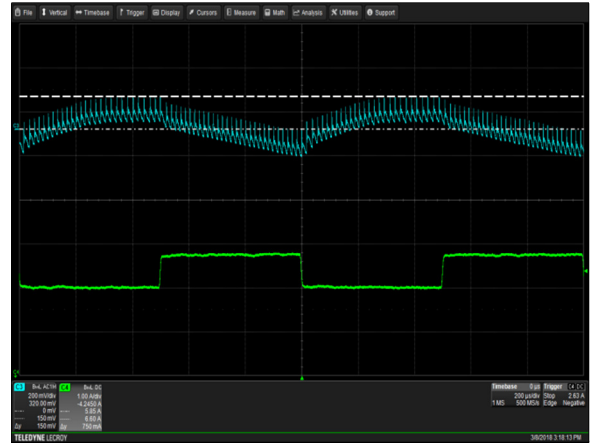

Figure 8: DA45C-J3WUS Transient Response (Vo=5V)
 Vin = 115Vac Load: Io = 100% to 75%, 0.15A/us slew rate
 Ch 3: Vo Ch 4: Io

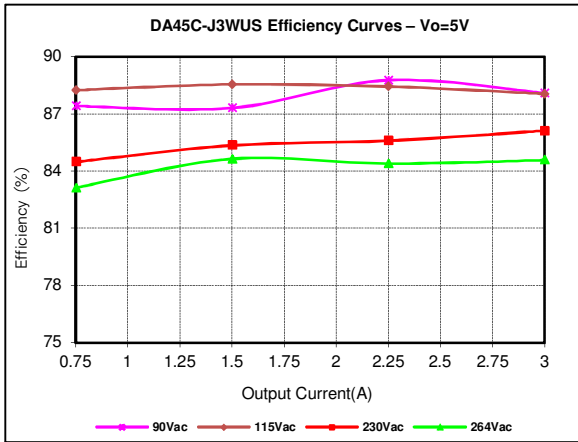

Figure 9: DA45C-J3WUS Efficiency Curves @ 25 degC
 Vo=5V
 Vin = 90 to 264Vac Load: Io = 25% increment to 3A

ELECTRICAL SPECIFICATIONS

DA45C-J3WUS Performance Curves (Vo=9V)

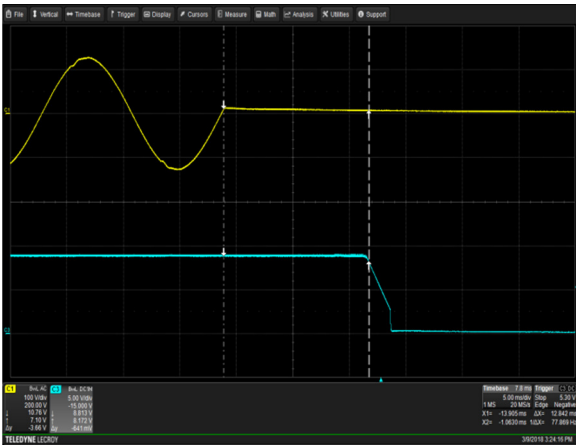

Figure 10: DA45C-J3WUS Hold-up Time (Vo=9V)
 Vin = 90Vac/63Hz/0° Load: Io = 3A
 Ch 1: V_{IN} Ch 3: Vo

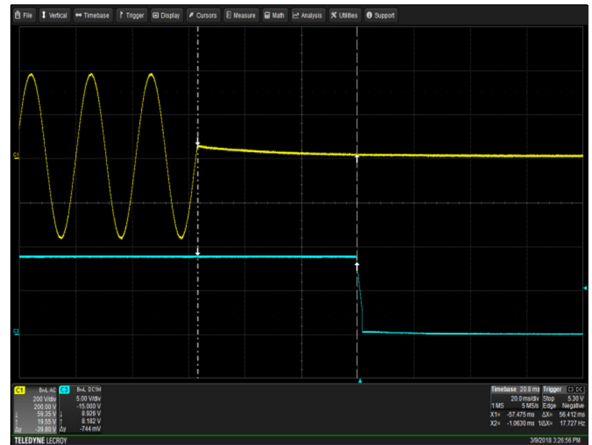

Figure 11: DA45C-J3WUS Hold-up Time (Vo=9V)
 Vin = 264Vac/47Hz/0° Load: Io = 3A
 Ch 1: V_{IN} Ch 3: Vo

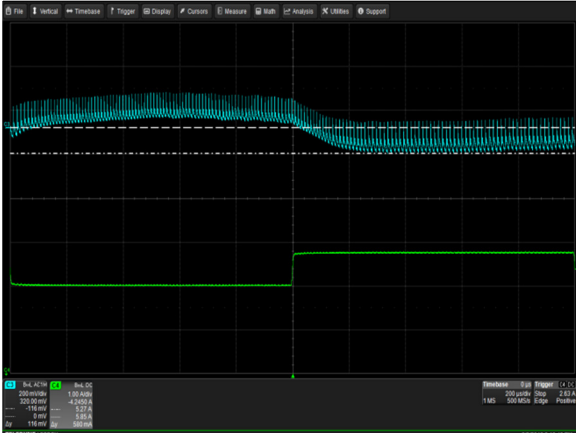

Figure 12: DA45C-J3WUS Transient Response (Vo=9V)
 Vin = 115Vac Load: Io = 75% to 100%, 0.15A/us slew rate
 Ch 3: Vo Ch 4: Io

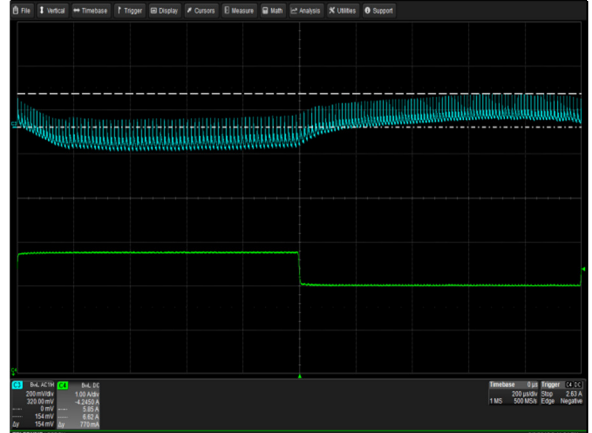

Figure 13: DA45C-J3WUS Transient Response (Vo=9V)
 Vin = 115Vac Load: Io = 100% to 75%, 0.15A/us slew rate
 Ch 3: Vo Ch 4: Io

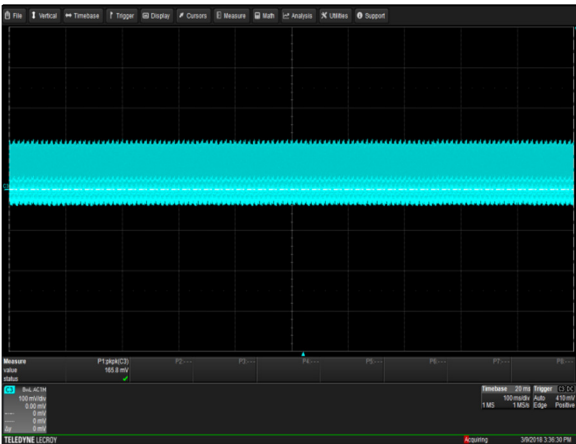

Figure 14: DA45C-J3WUS Output Ripple and Noise (Vo=9V)
 Vin = 115Vac Load: Io = 3A
 Ch 3: Vo

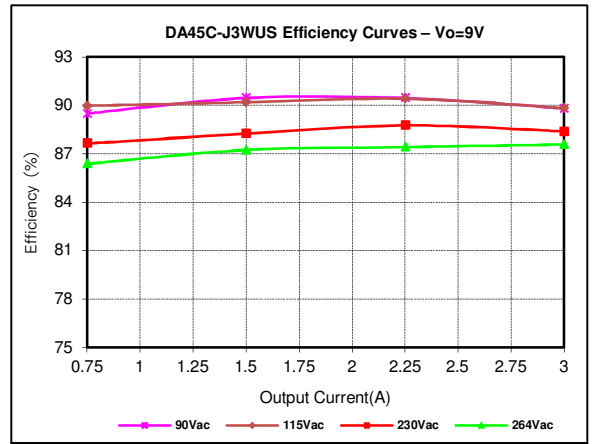

Figure 15: DA45C-J3WUS Efficiency Curves @ 25 degC
 Vo=9V
 Vin = 90 to 264Vac Load: Io = 25% increment to 3A

ELECTRICAL SPECIFICATIONS

DA45C-J3WUS Performance Curves (Vo=15V)

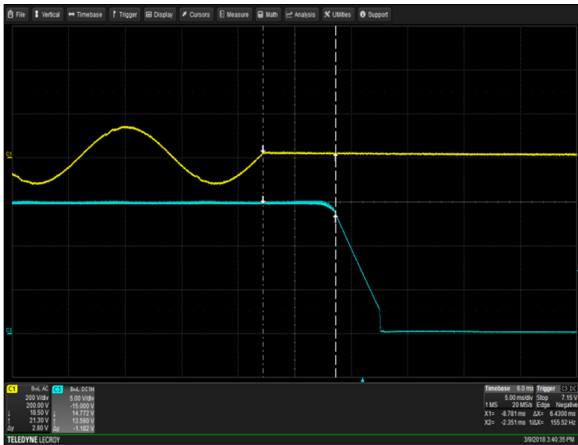

Figure 16: DA45C-J3WUS Hold-up Time (Vo=15V)
 Vin = 90Vac/63Hz/0° Load: Io = 3A
 Ch 1: V_{IN} Ch 3: Vo

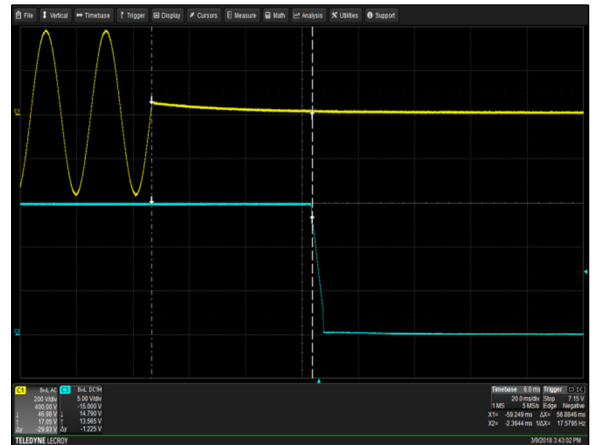

Figure 17: DA45C-J3WUS Hold-up Time (Vo=15V)
 Vin = 264Vac/47Hz/0° Load: Io = 3A
 Ch 1: V_{IN} Ch 3: Vo

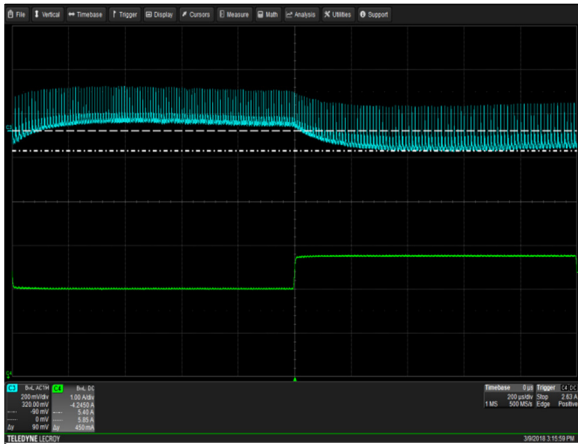

Figure 18: DA45C-J3WUS Transient Response (Vo=15V)
 Vin = 115Vac Load: Io = 75% to 100%, 0.15A/us slew rate
 Ch 3: Vo Ch 4: Io

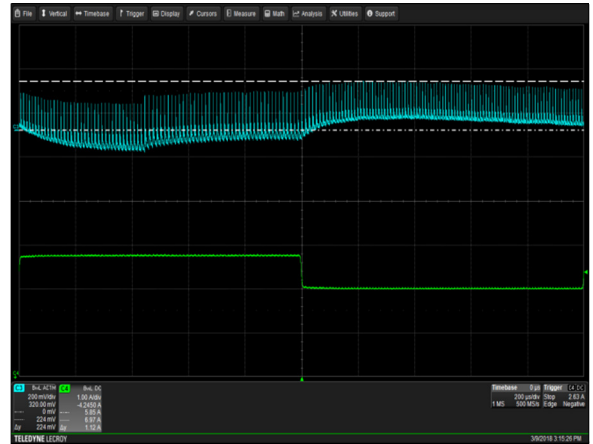

Figure 19: DA45C-J3WUS Transient Response (Vo=15V)
 Vin = 115Vac Load: Io = 100% to 75%, 0.15A/us slew rate
 Ch 3: Vo Ch 4: Io

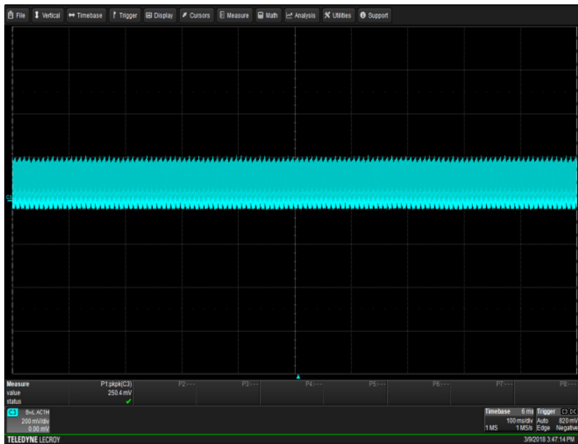

Figure 20: DA45C-J3WUS Output Ripple and Noise (Vo=15V)
 Vin = 115Vac Load: Io = 3A
 Ch 3: Vo

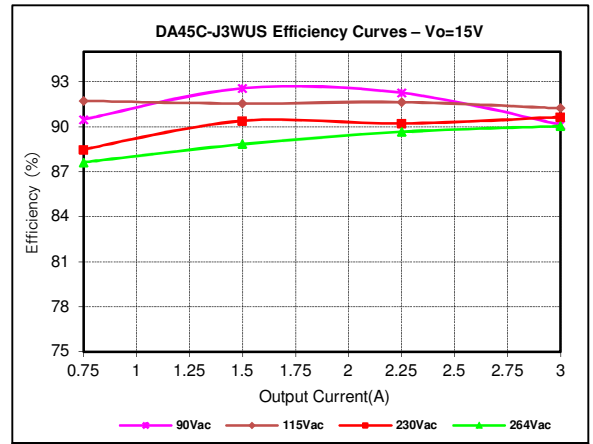

Figure 21: DA45C-J3WUS Efficiency Curves @ 25 degC
 Vo=15V
 Vin = 90 to 264Vac Load: Io = 25% increment to 3A

ELECTRICAL SPECIFICATIONS

DA45C-J3WUS Performance Curves (Vo=15V)

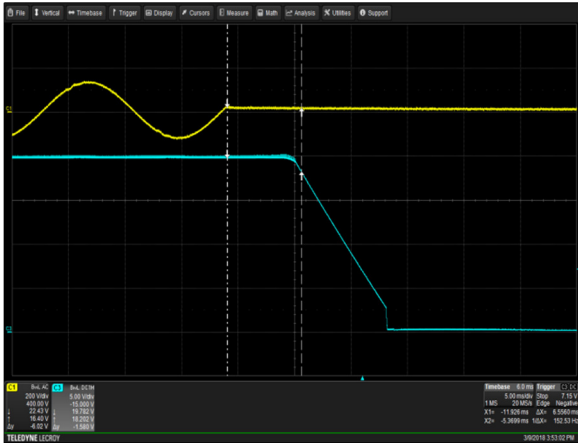

Figure 22: DA45C-J3WUS Hold-up Time (Vo=20V)
 Vin = 90Vac/63Hz/0° Load: Io = 2.25A
 Ch 1: V_{IN} Ch 3: Vo

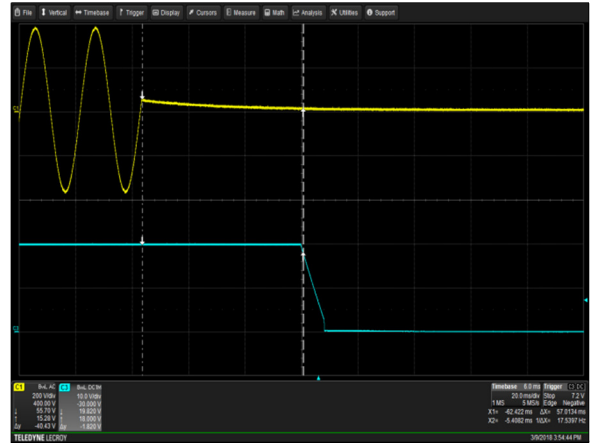

Figure 23: DA45C-J3WUS Hold-up Time (Vo=20V)
 Vin = 264Vac/47Hz/0° Load: Io = 2.25A
 Ch 1: V_{IN} Ch 3: Vo

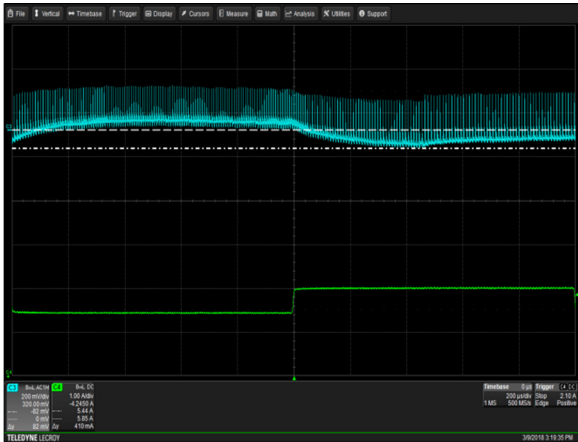

Figure 24: DA45C-J3WUS Transient Response (Vo=20V)
 Vin = 115Vac Load: Io = 75% to 100%, 0.15A/us slew rate
 Ch 3: Vo Ch 4: Io

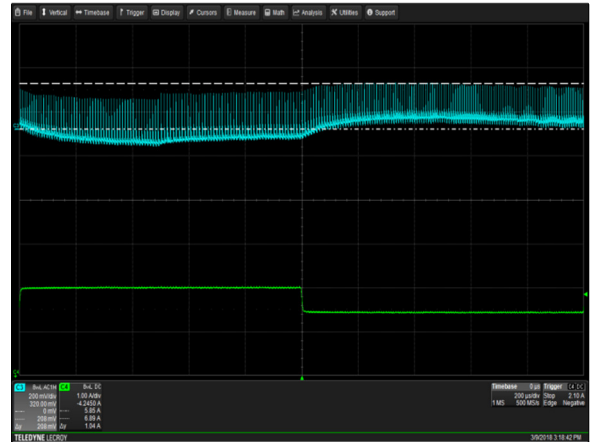

Figure 25: DA45C-J3WUS Transient Response (Vo=20V)
 Vin = 115Vac Load: Io = 100% to 75%, 0.15A/us slew rate
 Ch 3: Vo Ch 4: Io

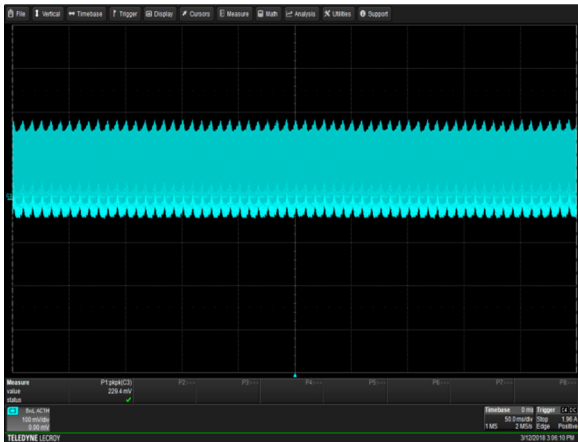

Figure 26: DA45C-J3WUS Output Ripple and Noise (Vo=20V)
 Vin = 115Vac Load: Io = 2.25A
 Ch 3: Vo

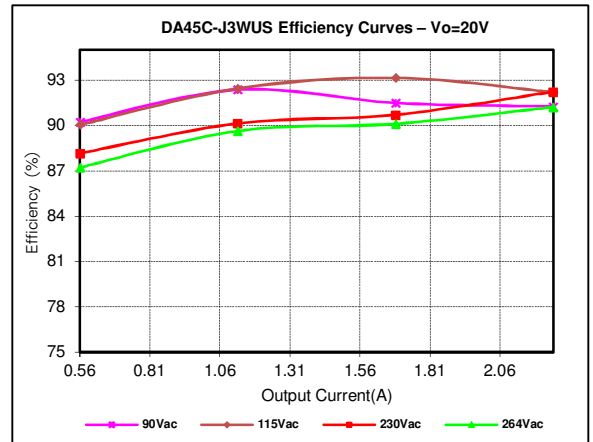

Figure 27: DA45C-J3WUS Efficiency Curves @ 25 degC
 Vo=20V
 Vin = 90 to 264Vac Load: Io = 25% increment to 2.25A

ELECTRICAL SPECIFICATIONS

Protection Function Specifications

Over Voltage Protection (OVP)

Over Voltage Protection is triggered when the PSU has an internal fault which results in the output rising over the regulation limit. The unit is latched to avoid damage to the load. AC Recycling is needed, with at least 5 seconds "off time" to reset the latch.

Parameter	Min	Typ	Max	Unit
5V Output Overvoltage	5.8	-	7	V
9V Output Overvoltage	10	-	13	V
15V Output Overvoltage	17	-	20	V
20V Output Overvoltage	22	-	26	V

Over Current Protection (OCP)

The DA45C series power supply includes internal current limit circuitry to prevent damage in the event of overload or short circuit. The protection mode is hiccup mode.

Parameter	Min	Typ	Max	Unit
5V Output Overcurrent	3	-	-	A
9V Output Overcurrent	3	-	-	A
15V Output Overcurrent	3	-	-	A
20V Output Overcurrent	2.3	-	-	A

Short Circuit Protection (SCP)

The DA45C series will withstand a continuous short circuit with no permanent damage, applied to its output during start-up or while running. The output will hiccup until the short-circuit is removed.

Over Temperature Protection (OTP)

The power supply is internally protected against over temperature conditions. When the OT circuit is activated, the power supply will latch off, with at least 5 seconds "off time" to reset the PSU after the temperature has decreased to normal levels.

MECHANICAL SPECIFICATIONS

Mechanical Outlines (Dimensioning)

DA45C-J3WUS Mechanical Outline

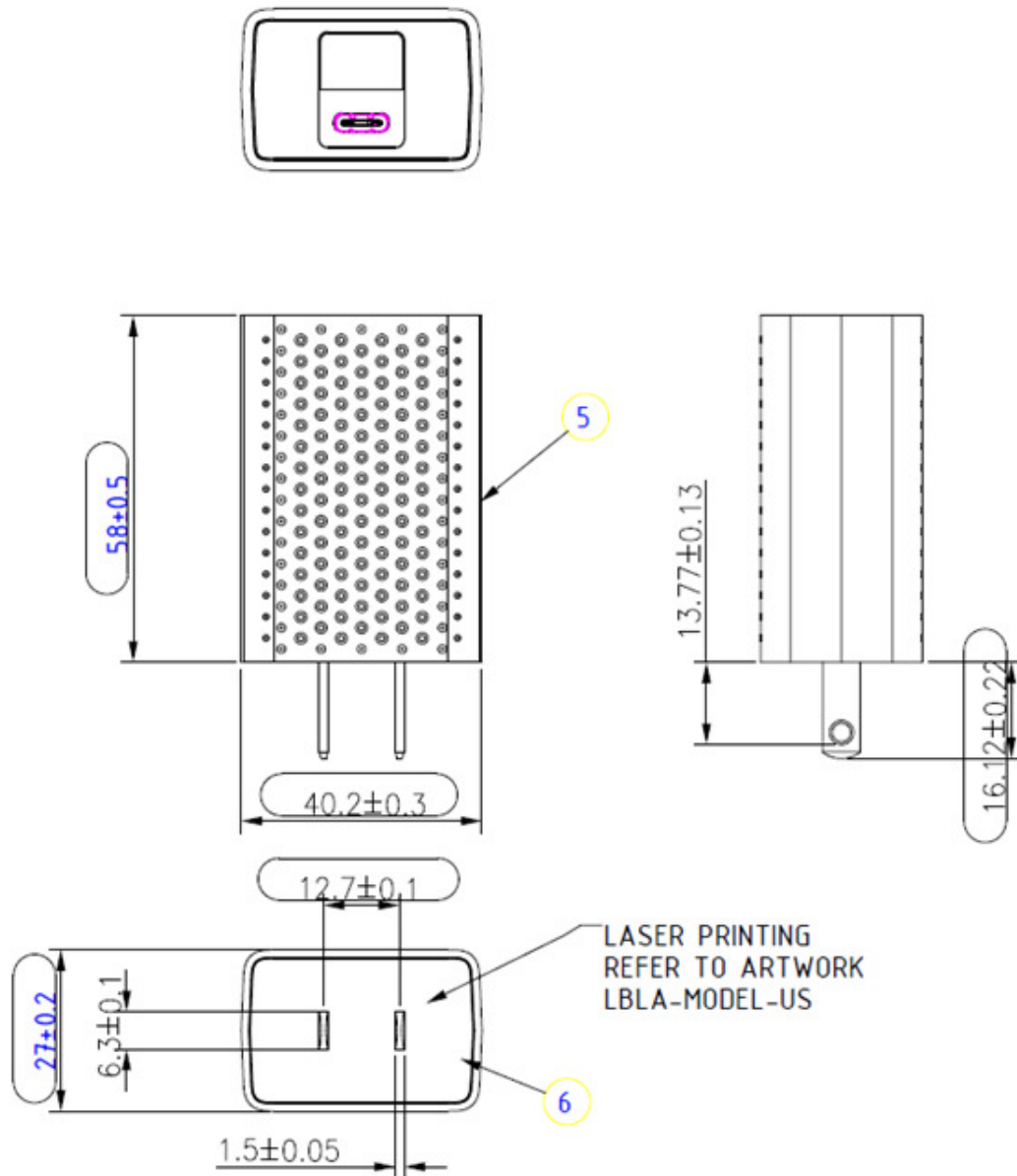

Note: All dimensions in mm.

MECHANICAL SPECIFICATIONS

Mechanical Outlines (Dimensioning)

DA45C-J3WCH Mechanical Outline

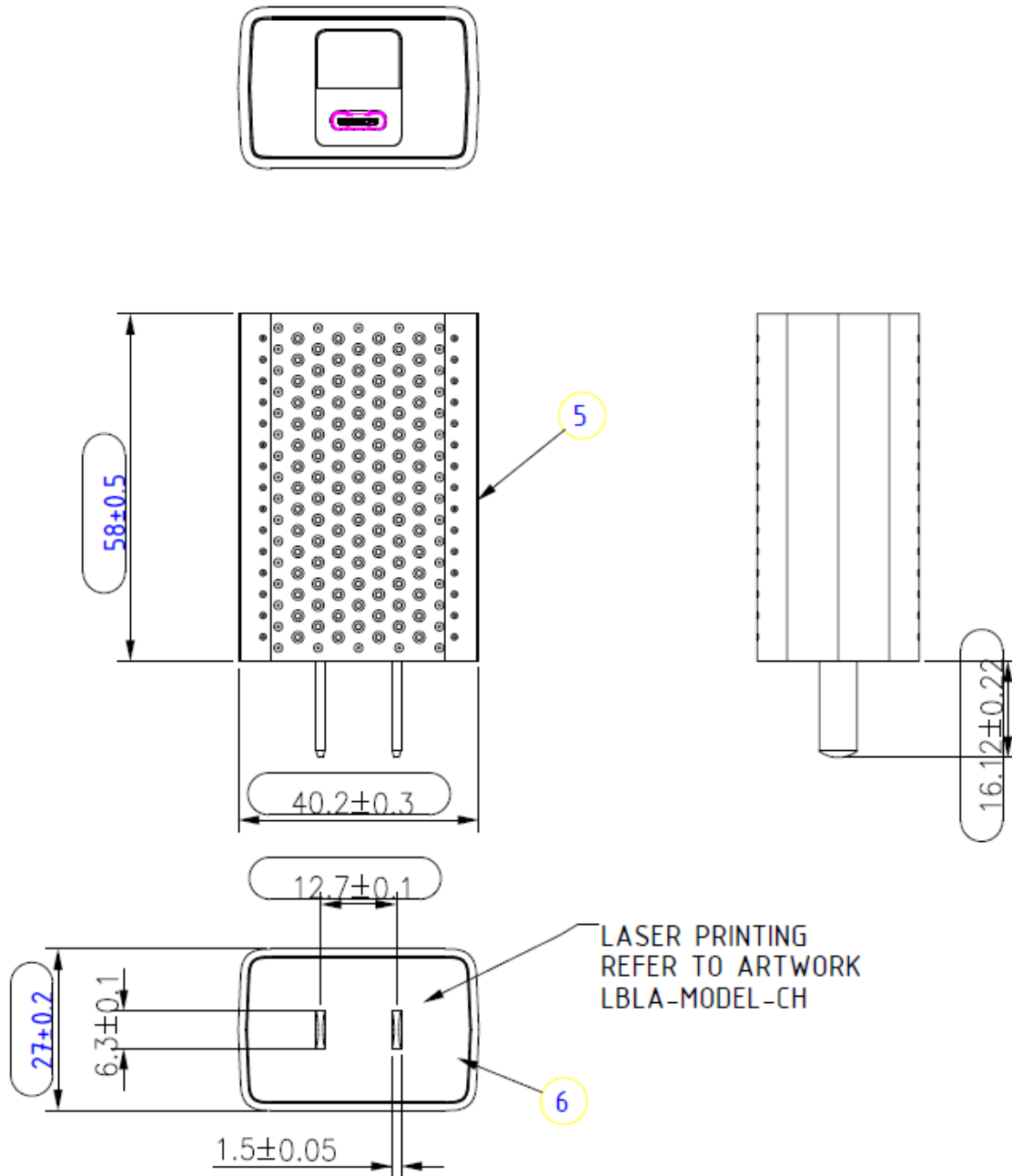

Note: All dimensions in mm.

MECHANICAL SPECIFICATIONS

Mechanical Outlines (Dimensioning)

DA45C-J3WEU Mechanical Outline

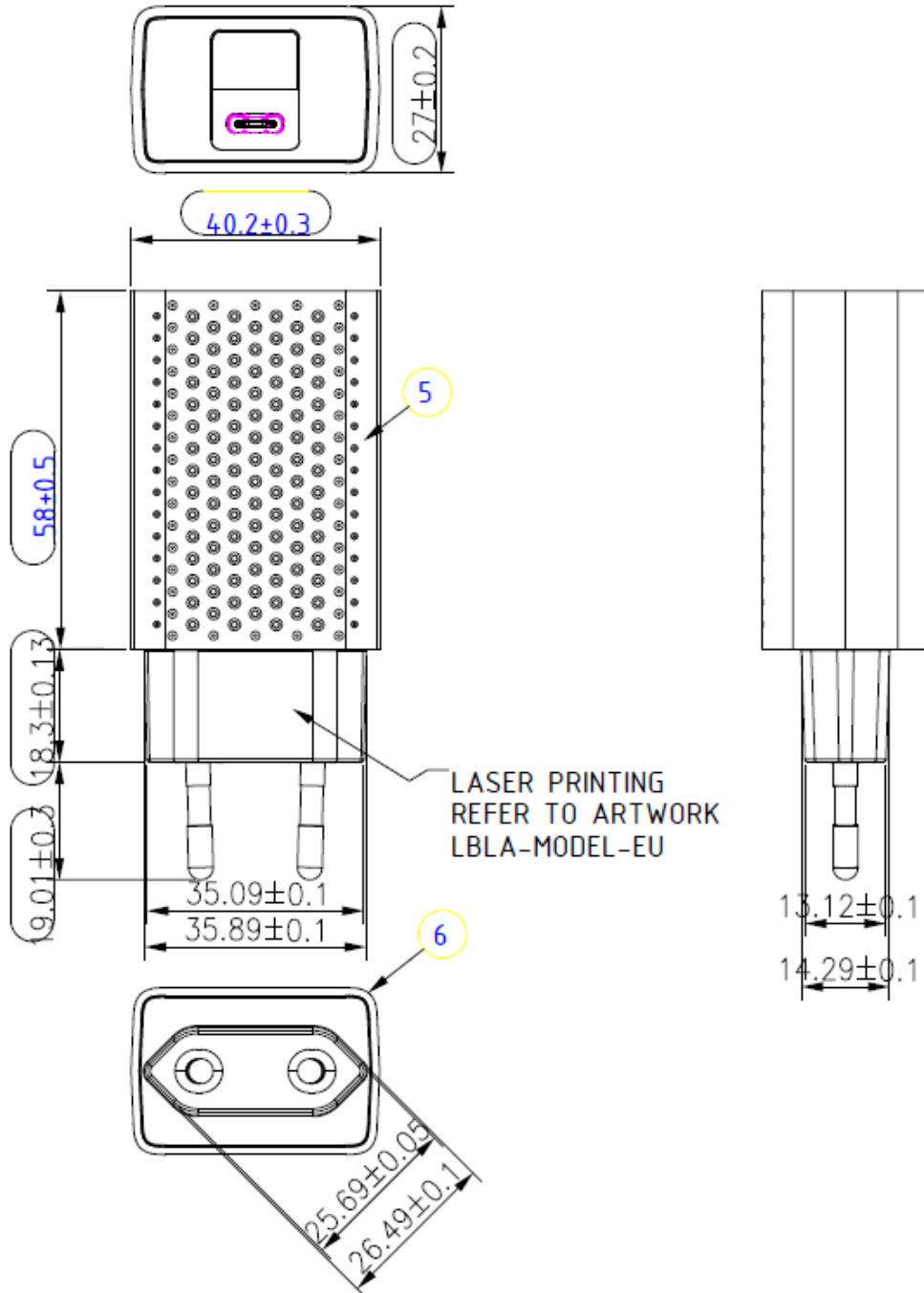

Note: All dimensions in mm.

MECHANICAL SPECIFICATIONS

Weight

The DA45C series weight is 0.176lb / 85g nominal.

ENVIRONMENTAL SPECIFICATIONS

EMC Immunity

DA45C series power supply is designed to meet the following EMC immunity specifications.

Table 4. Environmental Specifications	
Document	Description
EN55032, FCC part 15	Conducted & Radiated EMI, Class B
EN61000-3-3	Flicker, Voltage Fluctuations $\delta_{max} \leq 4\%$
EN61000-4-2	Electrostatic discharge immunity (ESD) test. Level 3, Criteria B
EN61000-4-3	Radiated, radio-frequency, electromagnetic field immunity test, 3V/m, Criteria A
EN61000-4-4	Electrical Fast Transient/Burst Immunity Test. Criteria A. Level 2
EN61000-4-5	Surge Test, Criteria A, Level 3
EN61000-4-6	Conducted immunity Test, 3V/m, Criteria A
EN61000-4-11	Voltage Dips and Interruptions: performance, Criteria B(For 100% reduction, Criteria C)

Common Mode Noise

Measure at cable output termination: AC source 132Vac/60Hz for US version and 264Vac/60Hz for other country versions. The common mode noise (starting from trailing switching period) at high frequency (spike time period $\geq 250\text{ns}$) shall be less than 2.0V.

The common mode noise at higher frequency (spike time period $< 250\text{ns}$) can be ignored.

ENVIRONMENTAL SPECIFICATIONS

Safety Certifications

The DA45C series power supply is in compliance with the following safety requirements.

Table 5. Safety Certifications for DA45C Series Power Supply System	
Document	Description
cUL/UL 62368-1	US and Canada Requirements
IEC/EN 62368-1	European Requirements
CCC	China approval for ITE; 5000m Altitude
PSE	Japan Approval
GS	GS Mark Certification
SPRING	PSB Spring certification
IRAM	Argentina IRAM certification
C-Tick	C-Tick mark
NSW	NSW Certificate
NRCan	Canada Requirements

ENVIRONMENTAL SPECIFICATIONS

Operating Temperature

The DA45C series power supply is designed to meet all of its specifications during any combination of operating ambient conditions and after exposure to any combination of non-operating ambient conditions specified in this section.

Table 6. Environmental Specifications				
Parameter	Condition	Typ	Max	Unit
Operating Ambient Temperature Range	Natural Convection, $I_O = I_{O,max}$	0	40	°C
Case (Enclosure) Temperature Rise Over Ambient Temperature	Natural Convection, $T_A = 40$ °C	-	45	°C
Electrolytic Capacitor Life Expectancy	$V_{IN,AC} = 115 / 230Vac$ $V_O = 20V, I_O = 2.25A, T_A = 25$ °C	7	-	K hours
MTBF	$T_A = 25$ °C, $V_{IN,AC} = 115 / 230Vac$ $V_O = 20V, I_O = 2.25A$	2000	-	K hours
Acoustic Noise ¹	All	-	25	dBa

Note 1 - The distance between the UUT and microphone is 0.5m.

APPLICATION NOTES

Pin definition

DA45C is USB Type-C output, it follows the Type-C protocol, please see below pin configuration. The “CC” pins will detect the device’s input voltage level, and gives the correct voltage level to device. If there is no signal on the CC pins, there will be no default output.

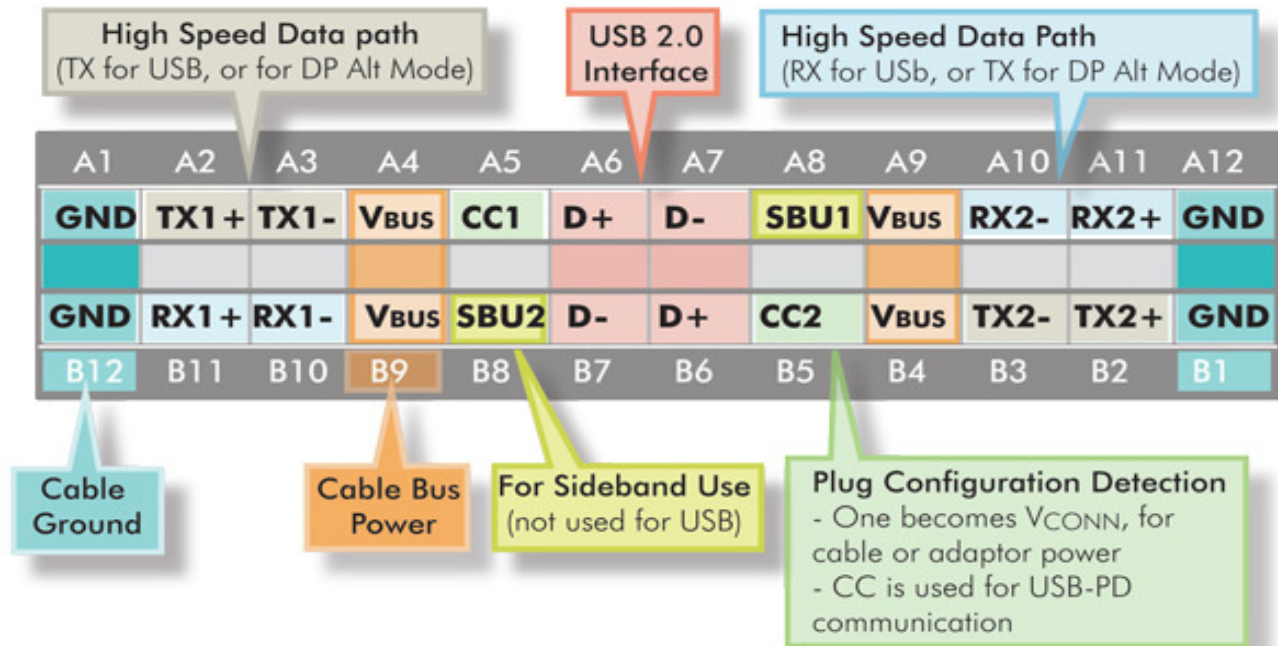

RECORD OF REVISION AND CHANGES

Issue	Date	Description	Originators
1.0	05.10.2018	First Issue	E. Wang



For international contact information,
visit advancedenergy.com.

powersale@aei.com (Sales Support)
productsupport.ep@aei.com (Technical Support)
+1 888 412 7832

ABOUT ADVANCED ENERGY

Advanced Energy (AE) has devoted more than three decades to perfecting power for its global customers. AE designs and manufactures highly engineered, precision power conversion, measurement and control solutions for mission-critical applications and processes.

Our products enable customer innovation in complex applications for a wide range of industries including semiconductor equipment, industrial, manufacturing, telecommunications, data center computing, and medical. With deep applications know-how and responsive service and support across the globe, we build collaborative partnerships to meet rapid technological developments, propel growth for our customers, and innovate the future of power.

PRECISION | POWER | PERFORMANCE

Specifications are subject to change without notice. Not responsible for errors or omissions. ©2020 Advanced Energy Industries, Inc. All rights reserved. Advanced Energy®, and AE® are U.S. trademarks of Advanced Energy Industries, Inc.