

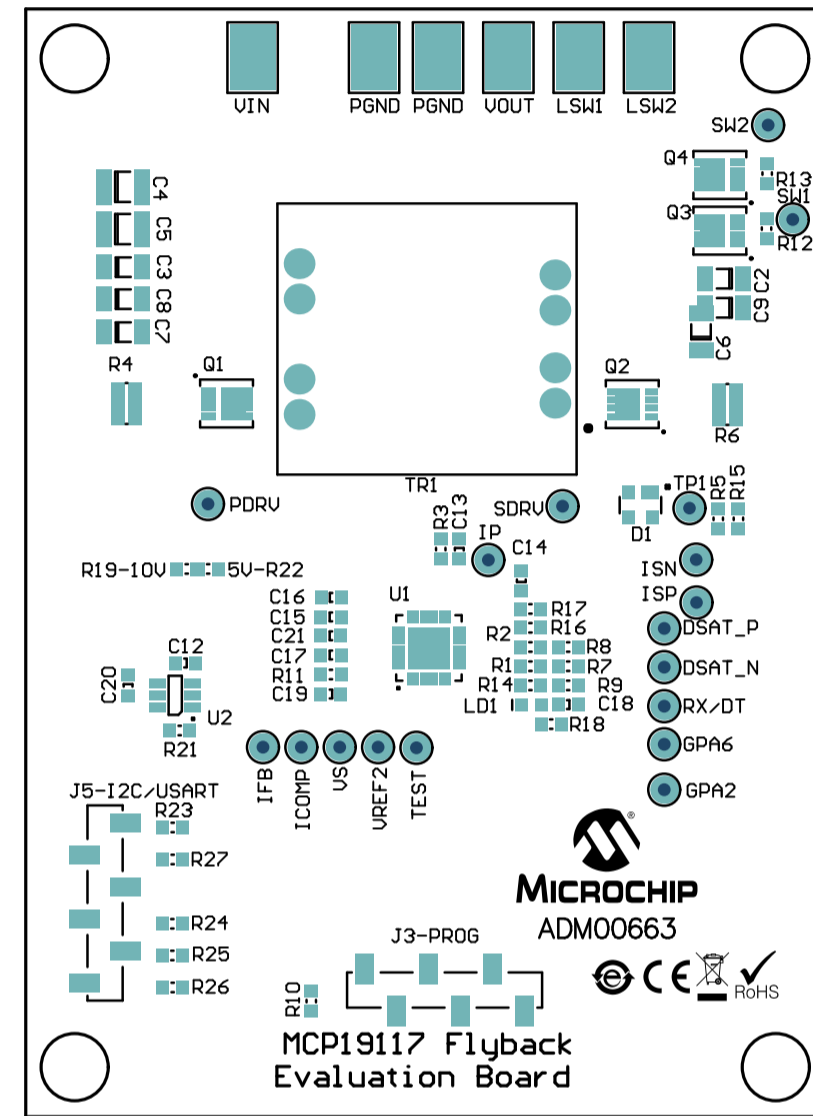



REV	ECO	Comments	Date

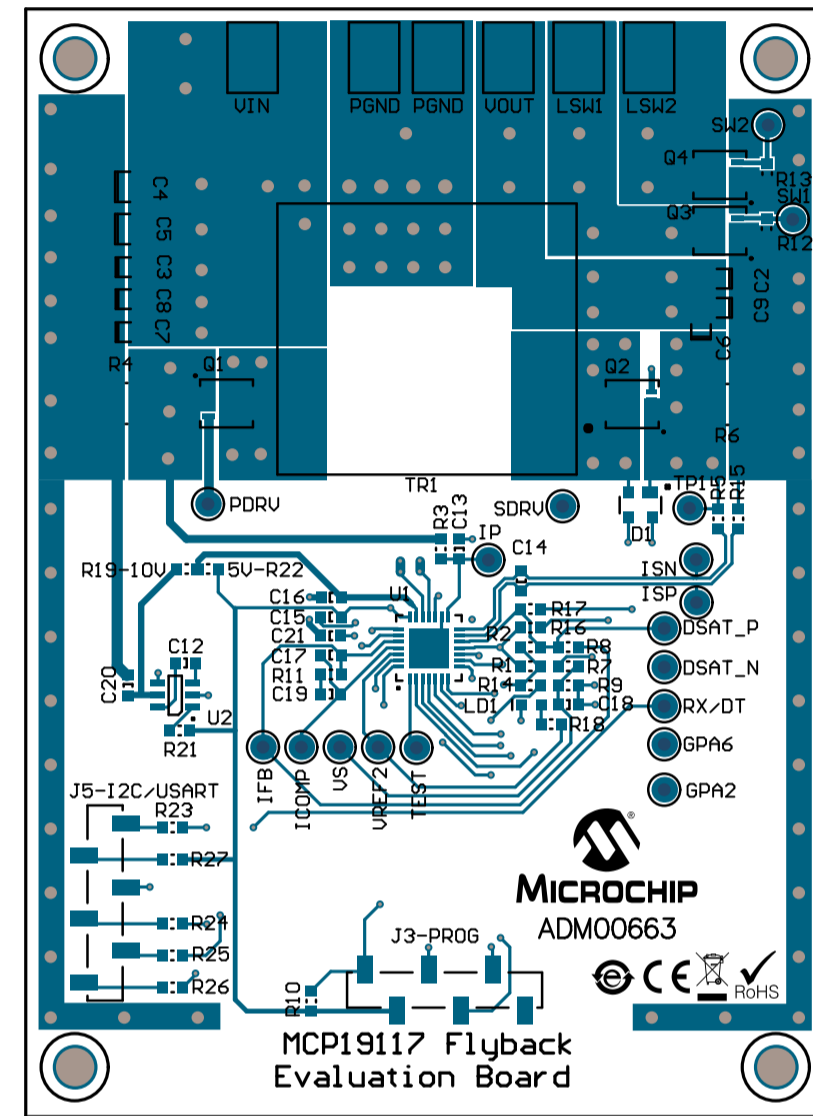

 MICROCHIP Microchip Technology Inc. 2355 W. Chandler Blvd. Chandler, AZ 85224	TITLE: MCP19117 Standalone Evaluation Board		PART NUMBER: ADM00663
	PCB DESIGNER: Yiwei Xiong	GERBER FILE: TOP Silk	
	ENGINEER: Yiwei Xiong	BOARD NUMBER: 04-10403	DATE: 2/25/2016
	PCB FILE NAME: MCP19117 Standalone Flyback MCL_	LAYER NAME: ALLGND_A.PcbDoc	REV: 10mm 400mil

REV	ECO	Comments	Date



 MICROCHIP Microchip Technology Inc. 2355 W. Chandler Blvd. Chandler, AZ 85224	TITLE: MCP19117 Standalone Evaluation Board PART NUMBER: ADM00663		
	PCB DESIGNER: Yiwei Xiong	GERBER FILE: TOP Copper & Silk	
	ENGINEER: Yiwei Xiong	BOARD NUMBER: 04-10403	DATE: 2/25/2016
	PCB FILE NAME: MCP19117 Standalone Flyback MCL_	LAYER NAME: ALLGND_A.PcbDoc	REV: 10mm 400mil

1 2 3 4 5 6

REV	ECO	Comments	Date

A

A

B

B

C

C

D

D

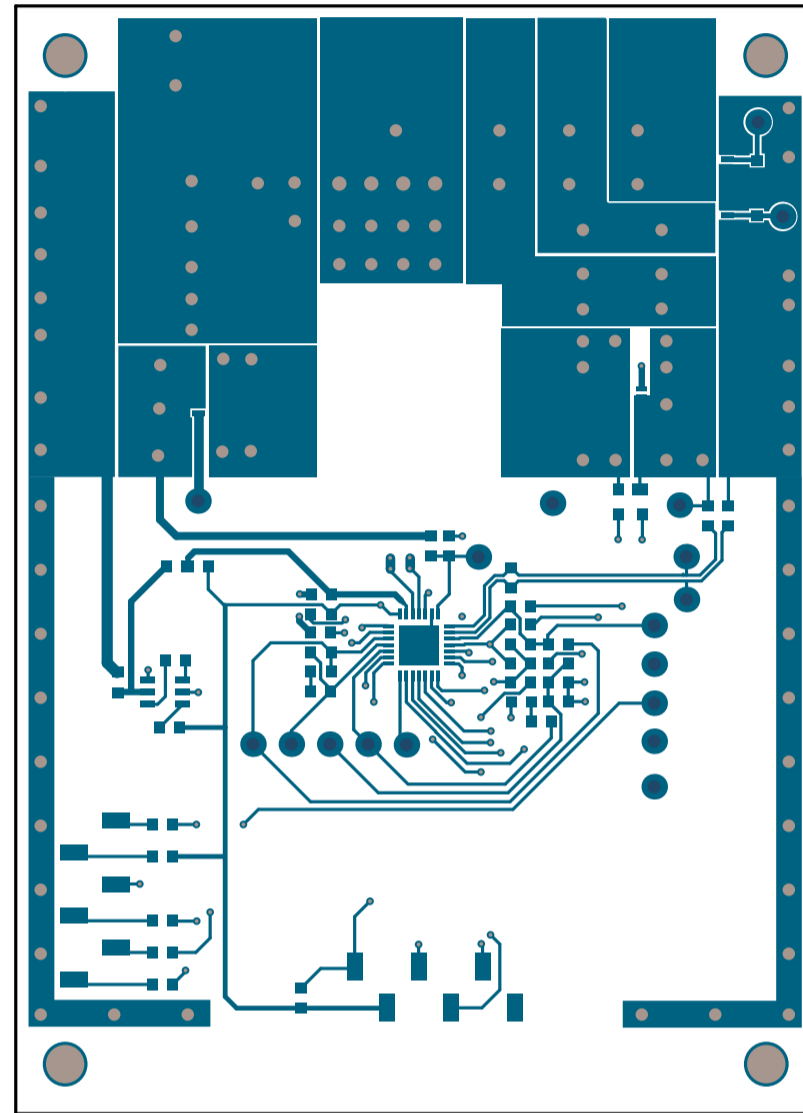

 MICROCHIP Microchip Technology Inc. 2355 W. Chandler Blvd. Chandler, AZ 85224	TITLE: MCP19117 Standalone Evaluation Board		PART NUMBER: ADM00663
	PCB DESIGNER: Yiwei Xiong	GERBER FILE: TOP Copper	
	ENGINEER: Yiwei Xiong	BOARD NUMBER: 04-10403	DATE: 2/25/2016
	PCB FILE NAME: MCP19117 Standalone Flyback MCL_ALLGND_A.PcbDoc	LAYER NAME: ALLGND_A.PcbDoc	REV: 10mm 400mil

1 2 3 4 5 6

1 2 3 4 5 6

REV	ECO	Comments	Date

A

A

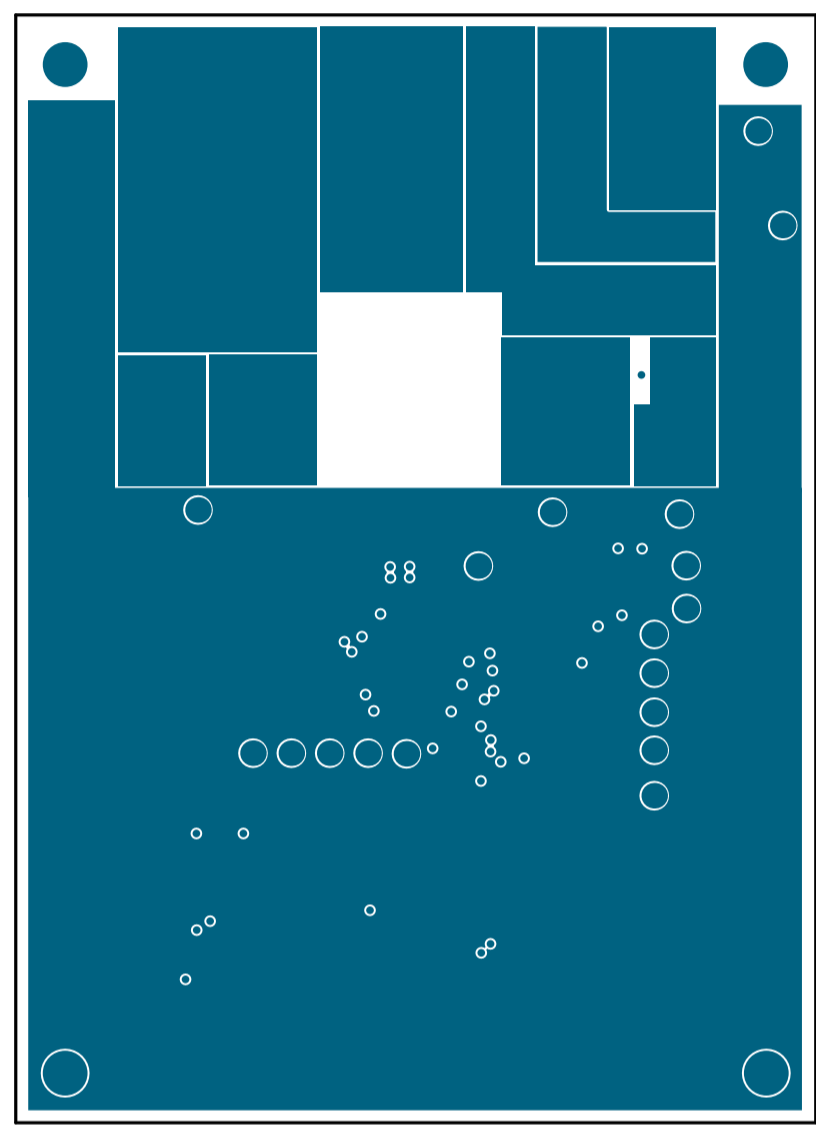

B

B

C

C

D

D

1 2 3 4 5 6

 MICROCHIP Microchip Technology Inc. 2355 W. Chandler Blvd. Chandler, AZ 85224	TITLE: MCP19117 Standalone Evaluation Board		PART NUMBER: ADM00663
	PCB DESIGNER: Yiwei Xiong	GERBER FILE: Mid-layer1	
	ENGINEER: Yiwei Xiong	BOARD NUMBER: 04-10403	DATE: 2/25/2016
	PCB FILE NAME: MCP19117 Standalone Flyback MCL_ALLGND_A.PcbDoc	LAYER NAME: MCL_ALLGND_A.PcbDoc	REV:

1 2 3 4 5 6

REV	ECO	Comments	Date

A

A

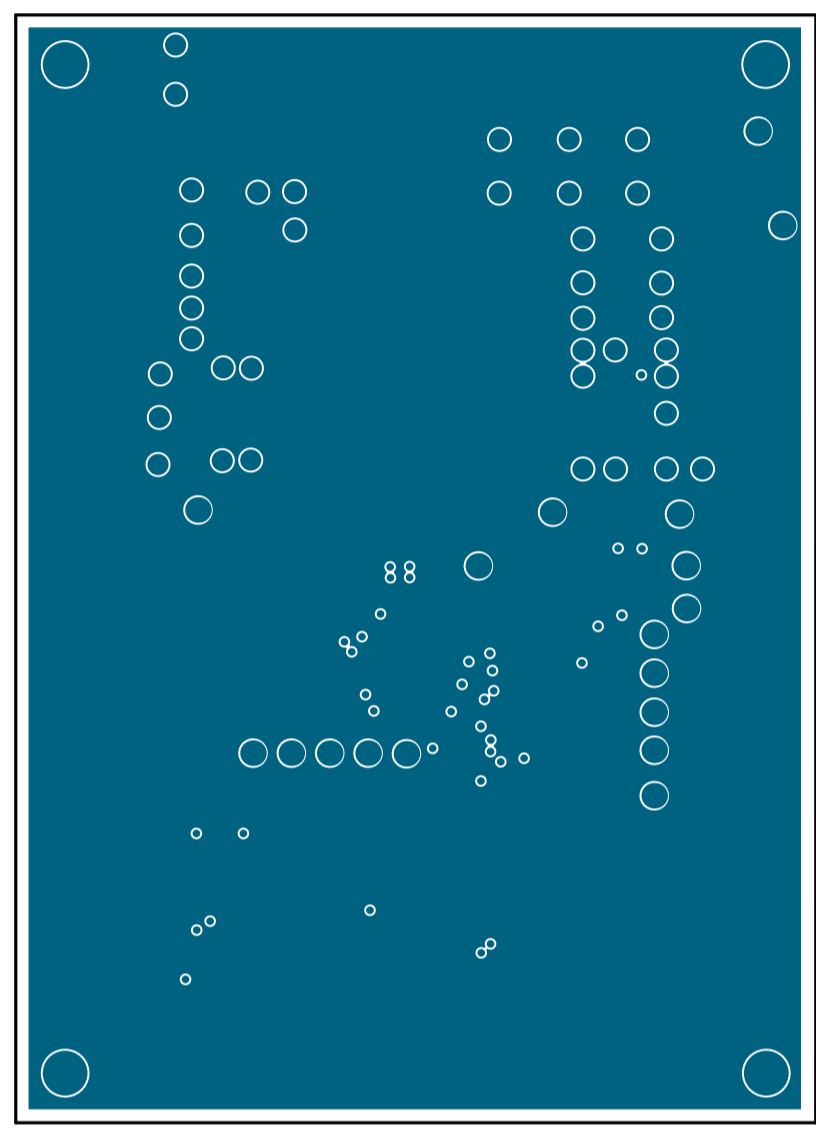

B

B

C

C

D

D

1 2 3 4 5 6

 MICROCHIP Microchip Technology Inc. 2355 W. Chandler Blvd. Chandler, AZ 85224	TITLE: MCP19117 Standalone Evaluation Board		PART NUMBER: ADM00663											
	PCB DESIGNER: Yiwei Xiong	GERBER FILE: Mid-layer2												
	ENGINEER: Yiwei Xiong	BOARD NUMBER: 04-10403	DATE: 2/25/2016											
	PCB FILE NAME: MCP19117 Standalone Flyback MCL_ALLGND_A.PcbDoc	LAYER NAME: MCL_ALLGND_A.PcbDoc	REV: <table border="1" style="display: inline-table; vertical-align: middle;"> <tr> <td>10mm</td> <td>+</td> <td>+</td> <td>+</td> <td>+</td> <td>+</td> </tr> <tr> <td>400mil</td> <td>+</td> <td>+</td> <td>+</td> <td>+</td> <td>+</td> </tr> </table>	10mm	+	+	+	+	+	400mil	+	+	+	+
10mm	+	+	+	+	+									
400mil	+	+	+	+	+									

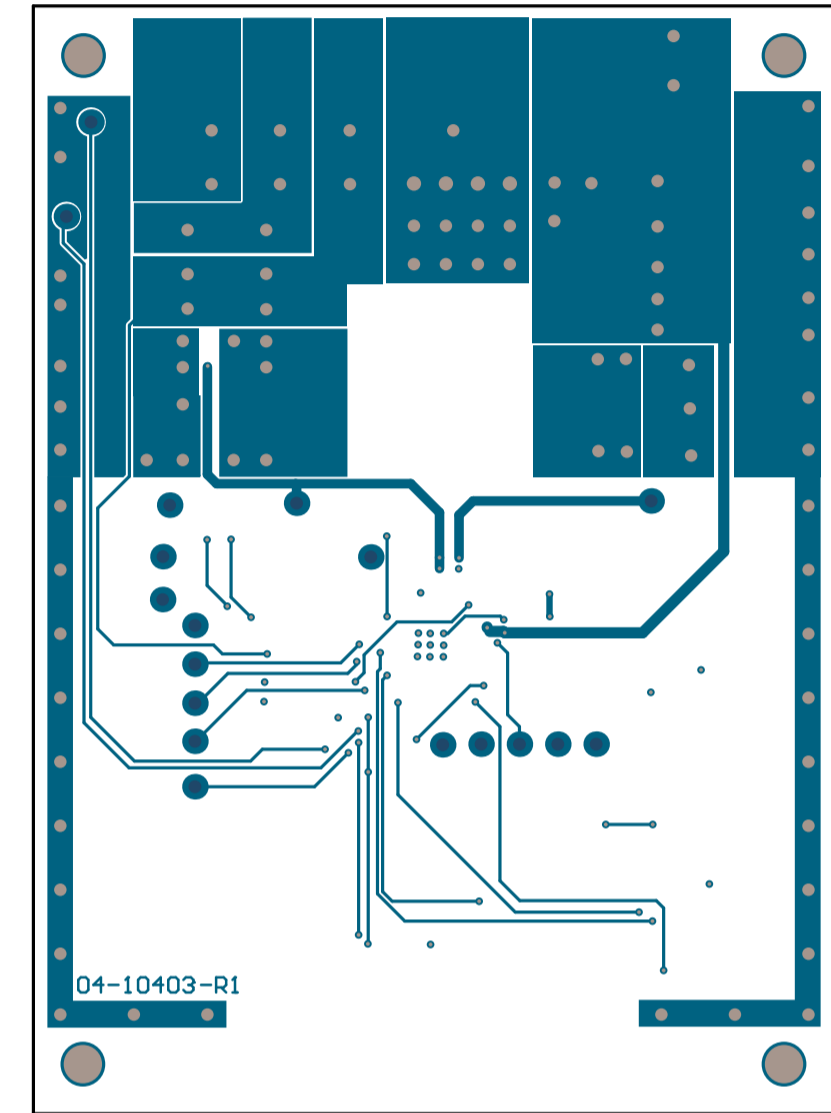

 MICROCHIP Microchip Technology Inc. 2355 W. Chandler Blvd. Chandler, AZ 85224	TITLE: MCP19117 Standalone Evaluation Board		PART NUMBER: ADM00663											
	PCB DESIGNER: Yiwei Xiong	GERBER FILE: BOTTOM Copper												
	ENGINEER: Yiwei Xiong	BOARD NUMBER: 04-10403	DATE: 2/25/2016											
	PCB FILE NAME: MCP19117 Standalone Flyback MCL_ALLGND_A.PcbDoc	LAYER NAME: ALLGND_A.PcbDoc	REV: <table border="1" style="display: inline-table; vertical-align: middle;"> <tr> <td>10mm</td> <td>+</td> <td>+</td> <td>+</td> <td>+</td> <td>+</td> </tr> <tr> <td>400µm</td> <td>+</td> <td>+</td> <td>+</td> <td>+</td> <td>+</td> </tr> </table>	10mm	+	+	+	+	+	400µm	+	+	+	+
10mm	+	+	+	+	+									
400µm	+	+	+	+	+									

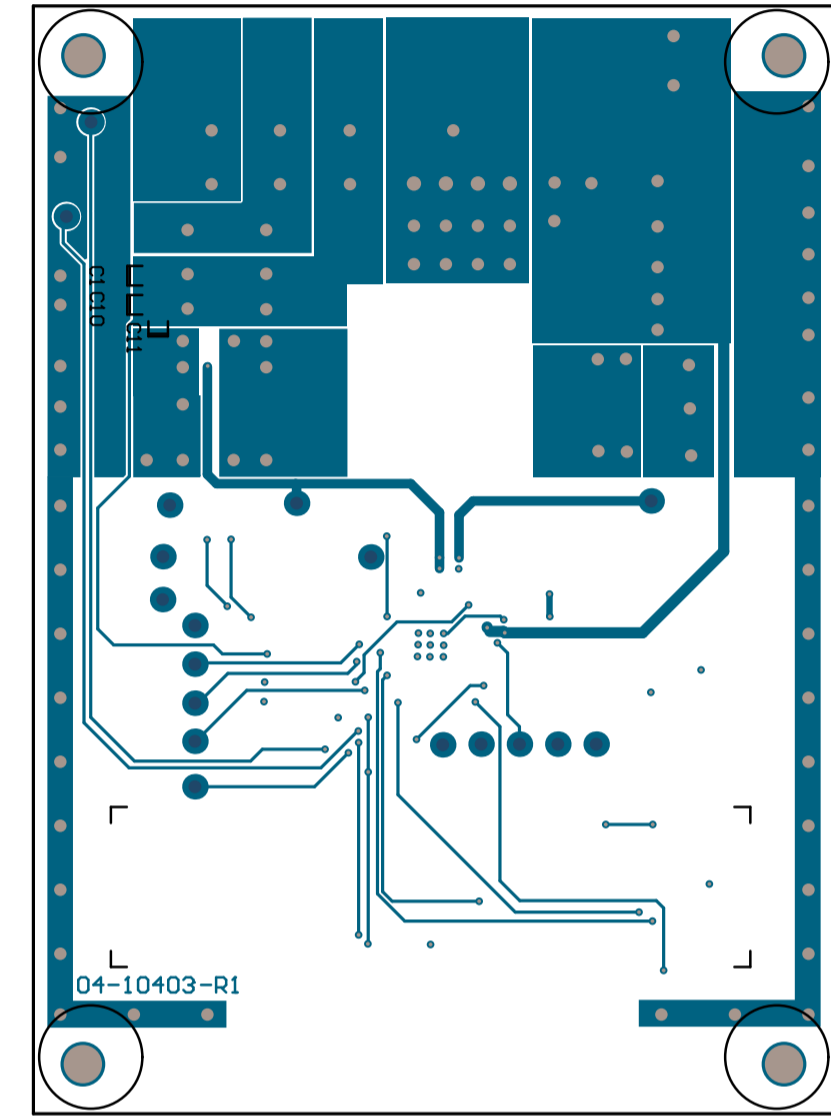

 MICROCHIP Microchip Technology Inc. 2355 W. Chandler Blvd. Chandler, AZ 85224	TITLE: MCP19117 Standalone Evaluation Board		PART NUMBER: ADM00663									
	PCB DESIGNER: Yiwei Xiong	GERBER FILE: Bottom Copper & Silk										
	ENGINEER: Yiwei Xiong	BOARD NUMBER: 04-10403	DATE: 2/25/2016									
	PCB FILE NAME: MCP19117 Standalone Flyback MCL_ALLGND_A.PcbDoc	LAYER NAME: ALLGND_A.PcbDoc	REV: <table border="1" style="display: inline-table; vertical-align: middle;"> <tr> <td>10mm</td> <td>1</td> <td>2</td> <td>3</td> <td>4</td> </tr> <tr> <td>400µm</td> <td>1</td> <td>2</td> <td>3</td> <td>4</td> </tr> </table>	10mm	1	2	3	4	400µm	1	2	3
10mm	1	2	3	4								
400µm	1	2	3	4								

1 2 3 4 5 6

A

A

B

B

C

C

D

D

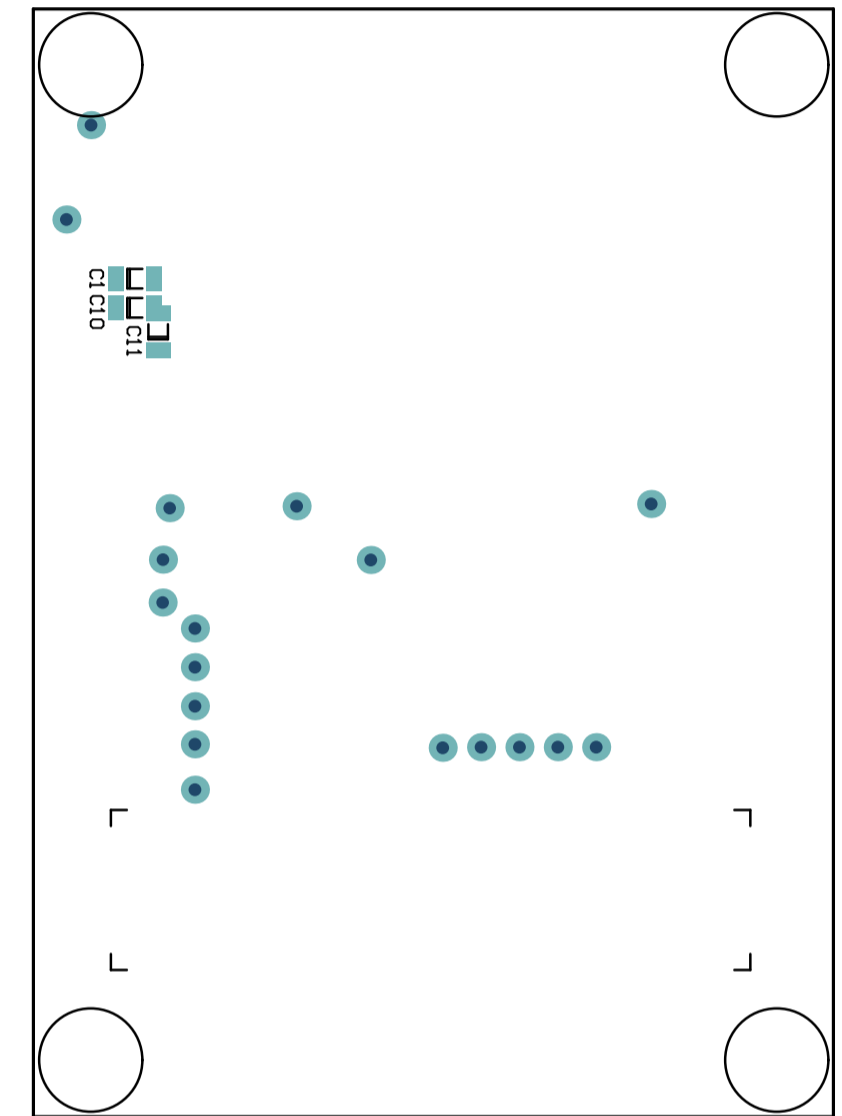

 MICROCHIP Microchip Technology Inc. 2355 W. Chandler Blvd. Chandler, AZ 85224	TITLE: MCP19117 Standalone Evaluation Board		PART NUMBER: ADM00663
	PCB DESIGNER: Yiwei Xiong	GERBER FILE: BOTTOM Silk	
	ENGINEER: Yiwei Xiong	BOARD NUMBER: 04-10403	DATE: 2/25/2016
	PCB FILE NAME: MCP19117 Standalone Flyback MCL_ALLGND_A.PcbDoc	LAYER NAME:	REV: 10mm 400mil

1 2 3 4 5 6