

SPECIFICATION

- Part No. : **MA705.A.ABC.001**
- Product Name : Pantheon Antenna 3in1 MA.705
Screw-Mount (Permanent Mount)
GPS/GLONASS/GALILEO / LTE Cellular/
2.4GHz/5.8GHz Combination antenna
- Features : Cellular
- 700/850/900/1700/1800/2100MHz
 - LTE/GSM/CDMA/UMTS/HSPA
- GPS/GLONASS/GALILEO 1575~1602MHz – 4 dBiC
2.4GHz/5.8GHz 4dBi (incl. 3m cable)
IP67 Waterproof
High Efficiency / Peak Gain Outdoor Antenna
Advanced RF Design and Materials
Heavy Duty – Integrated Metal Base/ Ground-plane
ABS High Isolation Gasket
Custom cables and connectors available
RoHS Compliant



1. Introduction

The Pantheon MA705 antenna is an omni-directional heavy-duty, fully IP67 waterproof external M2M antenna for use in telematics, transportation and remote monitoring applications. The Pantheon series is designed for RF professionals who accept no performance compromises whatsoever. The MA705 combines a 3in1 GPS/GLONASS/GALILEO, Cellular 700~2200MHz (4G/3G/2G) and 2.4GHz/5.8GHz antenna with the highest efficiency and peak gain possible. Unlike our competitors who don't measure cable loss the specification is measured at 3 meters (10ft) to show real performance in the field. The antenna screws down permanently onto a roof or metal panel and can be pole or wall-mounted.

Antenna includes a high isolation gasket to reduce risk of high voltage current on the mounting area, which prevents metal area short circuiting through the cable.

All while still maintaining 20dB isolation between antennas. It uses high-shielded PTFE dielectric ultra low loss cables that maintain low attenuation at all frequency bands, and high noise rejection, with an average loss of only 0.3dB per meter (0.1dB per foot), compared to 0.7dB for RG58 and 1.2dB for RG174. Because of this, the Pantheon maximizes chances of passing PTCRB and network approvals first time. The Pantheon also has excellent performance without need to attach to an external ground-plane due to its internal antennas coupling to its unique super strong integrated metal base. The antenna comes with a 3M adhesive waterproof layer to prevent water leaking under the antenna into the mounting hole. The Pantheon can also be supplied in single GPS/GLONASS/GALILEO, Cellular, Wi-Fi only versions, or at other frequencies.

2. Specification

GPS-GLONASS-GALILEO						
Centre Frequency	1575.42MHz / 1602MHz					
Bandwidth	10MHz					
Radiation Efficiency	50(without cable)					
Passive Gain @ Zenith	4.0 typ (with $\psi=140\text{mm}$ ground)					
VSWR	2					
Impedance	50 Ω					
DC Power Input Range	3 ~ 5V					
DC input	3.3V		4.0V		5.5V	
MHz	1575.42	1602	1575.42	1602	1575.42	1602
VSWR	2	2	2	2	2	2
LNA Gain	29.2	29	31	31	32.3	32
Noise Figure	3.1	3.1	3.2	3.2	3.4	3.4
Power Consumption	7.5	7.5	9.4	9.4	15	15
Band Attenuation	1520MHz: -20dB 1642MHz: -20dB		1520MHz: -20dB 1642MHz: -20dB		1520MHz: -20dB 1642MHz: -20dB	
Cable	3m RG-174 standard, fully customizable					
Connector	SMA(M) standard, fully customizable					

CELLULAR						
Frequency (MHz)	700~800	824~896	880~960	1710~1880	1850~1990	1710~2170
Peak Gain (dBi)*	2.1	2.5	3.1	2.3	1.6	2.3
Average Gain (dBi)*	1.5	1.8	2.0	1.5	0.5	0.0
Efficiency *	78%	76%	57%	47%	37%	36%
Impedance	50 Ω					
Polarization	Linear					
Radiation Pattern	Omni					
Cable	3m CFD200 standard, fully customizable					
Connector	SMA(M) standard, fully customizable					

WIFI				
Frequency (GHz)	2.4~2.5	4.7~5.0	5.0~5.4	5.4~5.9
Peak Gain (dBi) *	1.8	3.9	5.9	5.4
Average Gain (dBi) *	1.5	2.3	4.1	4.1
Efficiency *	54%	30%	33%	35%
VSWR	<=1.7:1			
Impedance	50Ω			
Polarization	Linear			
Radiation Pattern	Omni			
Cable	3m CFD200 standard, fully customizable			
Connector	RP-SMA(M) standard, standard, fully customizable			
MECHANICAL				
Dimensions	Height 85.7mm x Diameter 145.6m			
Casing	Wonderloy PC-540 PC/ABS Alloy			
Base and thread	CAN10 Zinc Alloy			
Thread diameter	M30 x 2 (30mm)			
Nut	Nickel Plated Iron			
Foam	3M 9448H			
Waterproof	IP67			
ENVIRONMENTAL				
Temperature Range	-40°C to 85°C			
Storage Temperature	-40°C to 90°C			
Humidity	Non-condensing 65°C 95% RH			

* Including 3 meters cable loss

LTE BANDS			
Band Number	LTE / LTE-Advanced / WCDMA / HSPA / HSPA+ / TD-SCDMA		
	Uplink	Downlink	Covered
1	UL: 1920 to 1980	DL: 2110 to 2170	✓
2	UL: 1850 to 1910	DL: 1930 to 1990	✗
3	UL: 1710 to 1785	DL: 1805 to 1880	✓
4	UL: 1710 to 1755	DL: 2110 to 2155	✓
5	UL: 824 to 849	DL: 869 to 894	✓
7	UL: 2500 to 2570	DL: 2620 to 2690	✗
8	UL: 880 to 915	DL: 925 to 960	✓
9	UL: 1749.9 to 1784.9	DL: 1844.9 to 1879.9	✓
11	UL: 1427.9 to 1447.9	DL: 1475.9 to 1495.9	✓
12	UL: 699 to 716	DL: 729 to 746	✓
13	UL: 777 to 787	DL: 746 to 756	✓
14	UL: 788 to 798	DL: 758 to 768	✓
17	UL: 704 to 716	DL: 734 to 746 (LTE only)	✓
18	UL: 815 to 830	DL: 860 to 875 (LTE only)	✓
19	UL: 830 to 845	DL: 875 to 890	✓
20	UL: 832 to 862	DL: 791 to 821	✓
21	UL: 1447.9 to 1462.9	DL: 1495.9 to 1510.9	✓
22	UL: 3410 to 3490	DL: 3510 to 3590	✗
23	UL: 2000 to 2020	DL: 2180 to 2200 (LTE only)	✓
24	UL: 1625.5 to 1660.5	DL: 1525 to 1559 (LTE only)	✓
25	UL: 1850 to 1915	DL: 1930 to 1995	✗
26	UL: 814 to 849	DL: 859 to 894	✓
27	UL: 807 to 824	DL: 852 to 869 (LTE only)	✓
28	UL: 703 to 748	DL: 758 to 803 (LTE only)	✓
29	UL: -	DL: 717 to 728 (LTE only)	✓
30	UL: 2305 to 2315	DL: 2350 to 2360 (LTE only)	✓
31	UL: 452.5 to 457.5	DL: 462.5 to 467.5 (LTE only)	✗
32	UL: -	DL: 1452 - 1496	✗
35		1850 to 1910	✓
38		2570 to 2620	✗
39		1880 to 1920	✓
40		2300 to 2400	✓
41		2496 to 2690	✗
42		3400 to 3600	✗
43		3600 to 3800	✗

*Covered bands represent an efficiency greater than 20%

3. GPS/GLONASS/GALILEO Antenna Characteristics

3.1. Block diagram

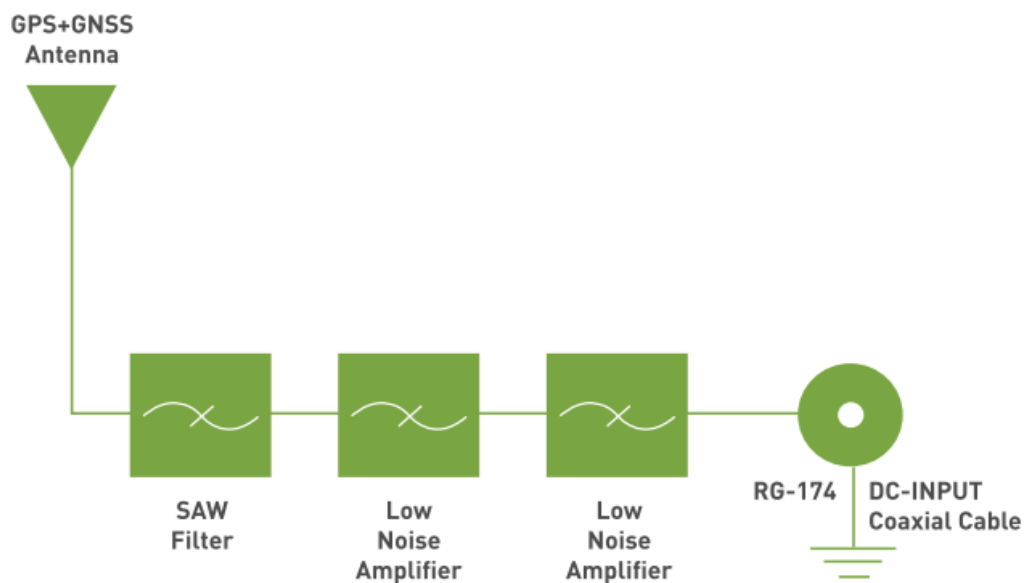

3.2. Return Loss

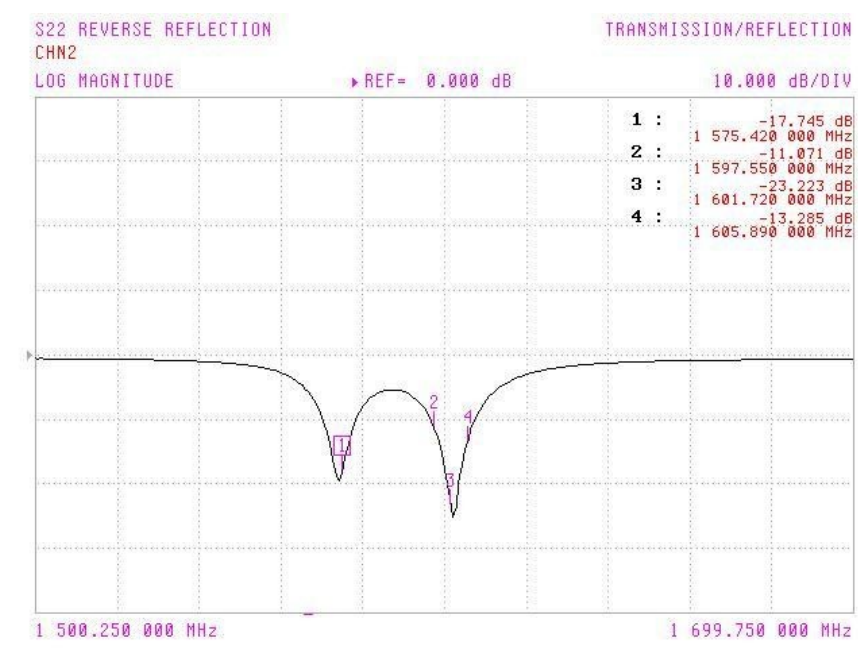

3.3. GPS/GLONASS/GALILEO Antenna Radiation Pattern

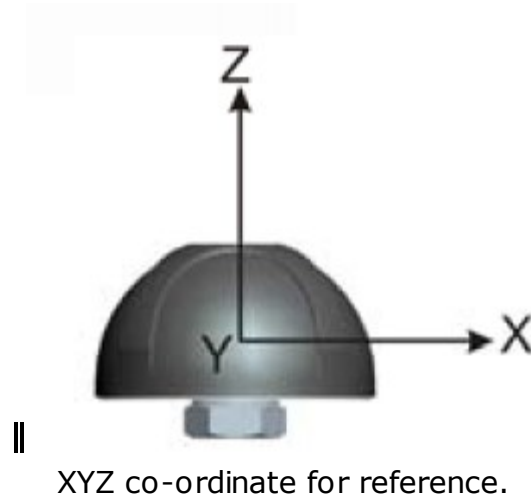

XZ Plane Free Space @1575.42MHz

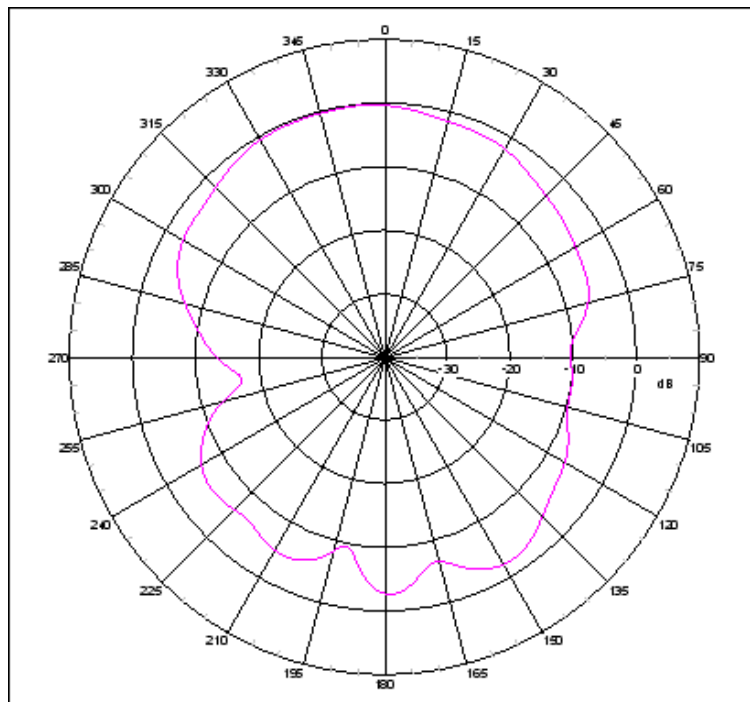

YZ Plane Free Space @1575.42MHz

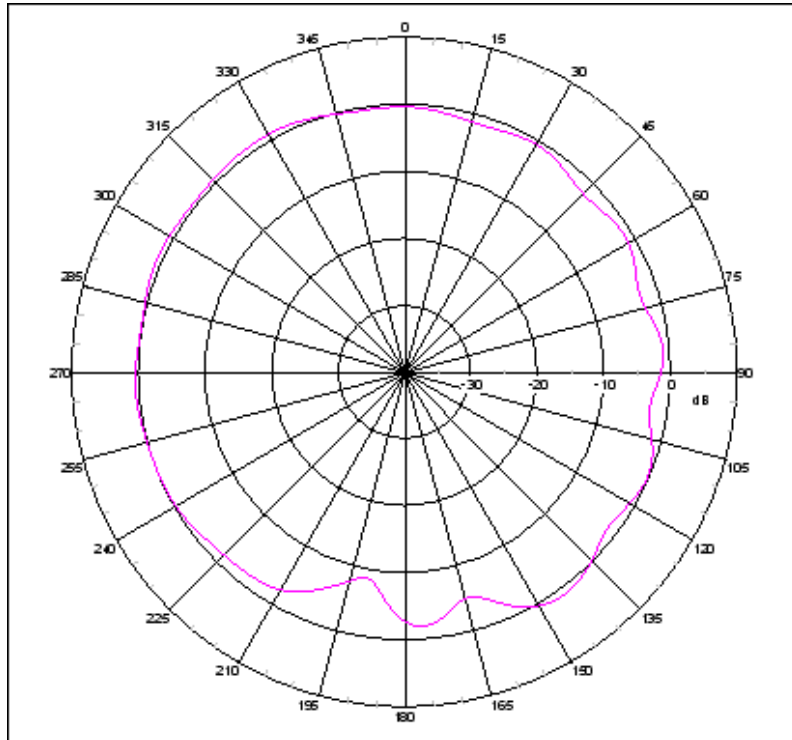

XZ Plane Free Space @1602MHz

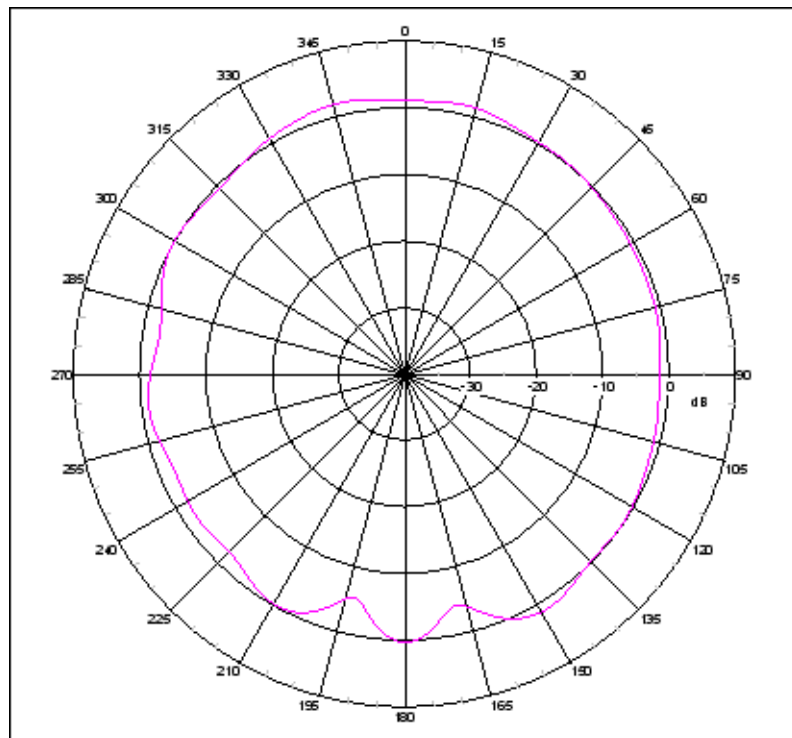

YZ Plane Free Space @1602MHz

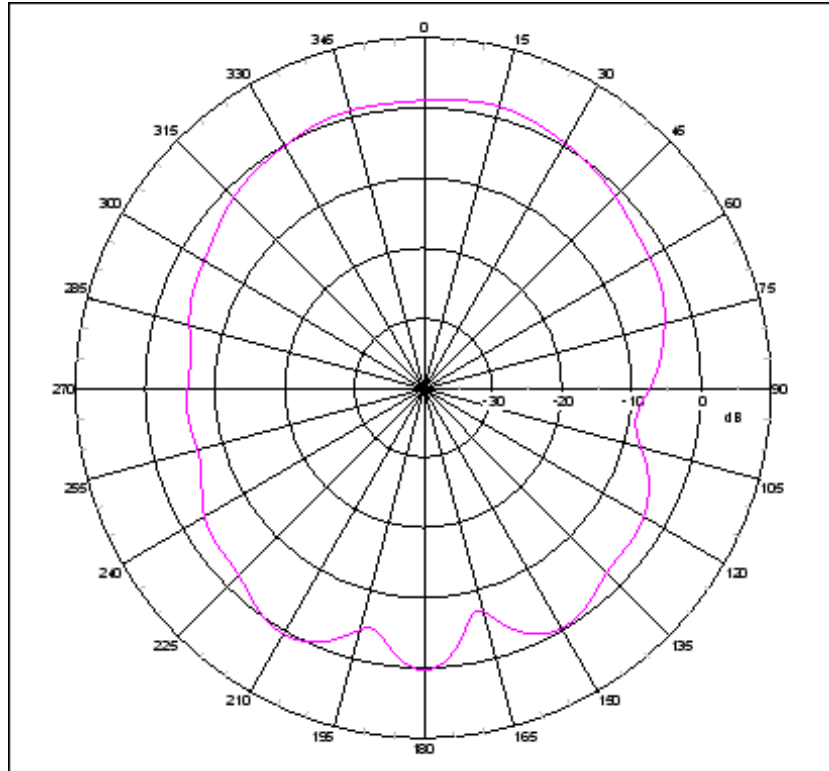

3.4. GPS/GLONASS/GALILEO LNA

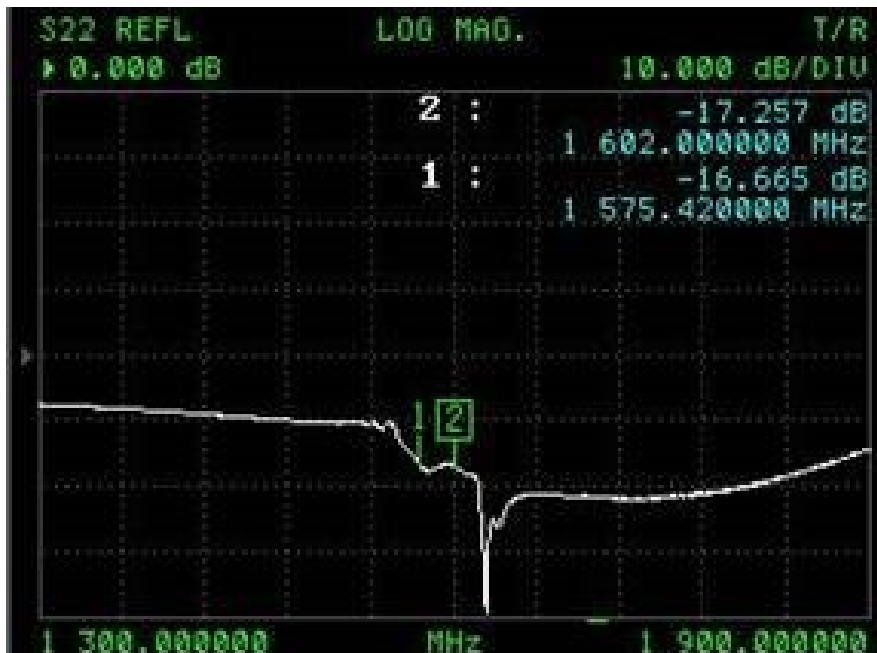
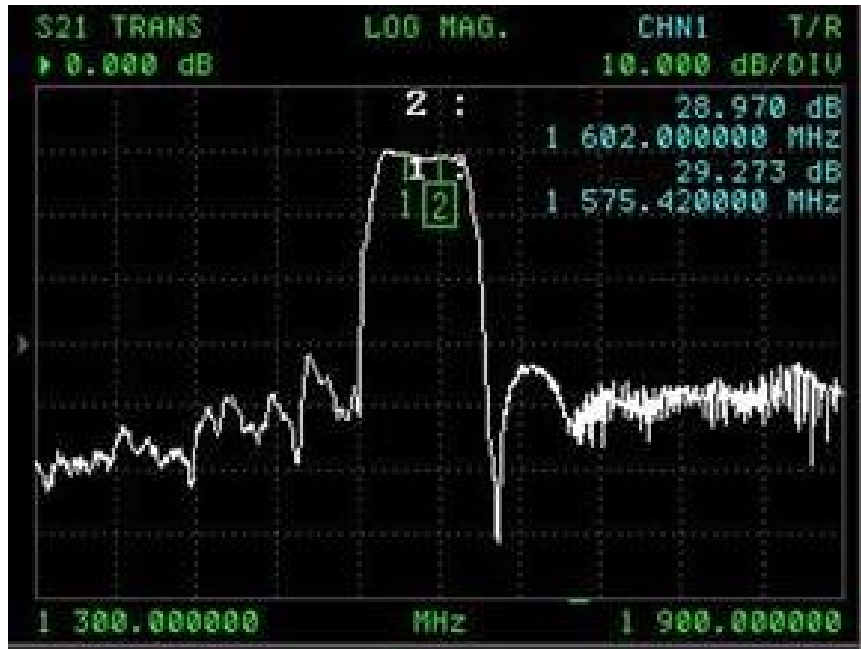

4. Cellular Antenna Characteristics

4.1. Return Loss

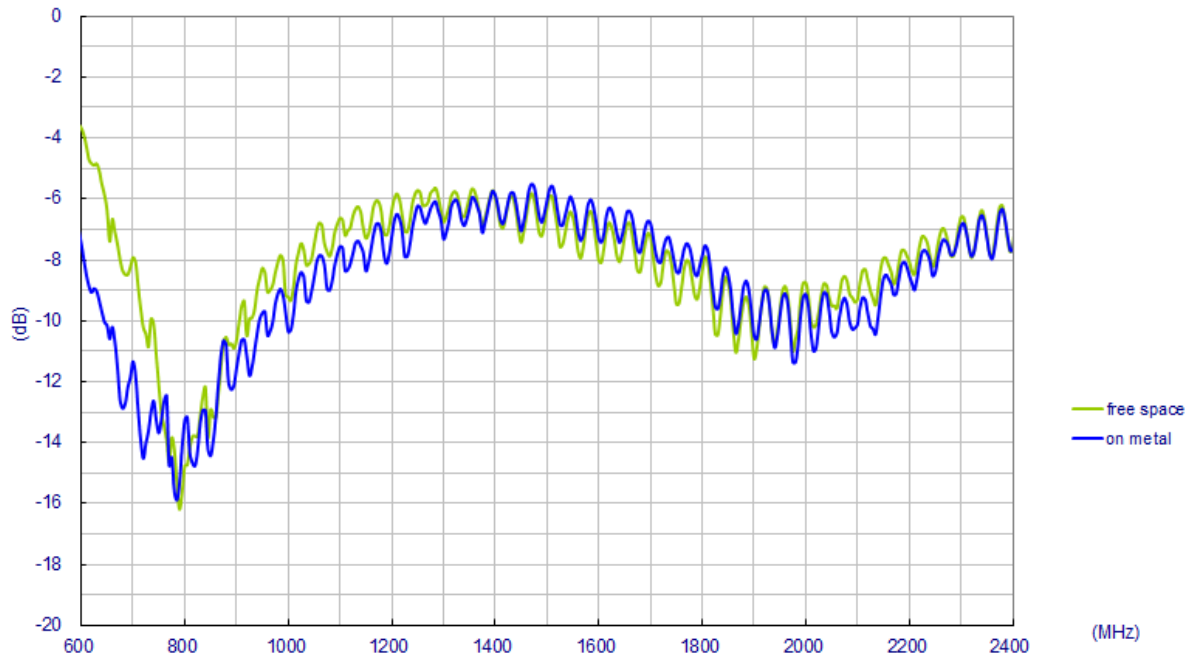

4.2. VSWR

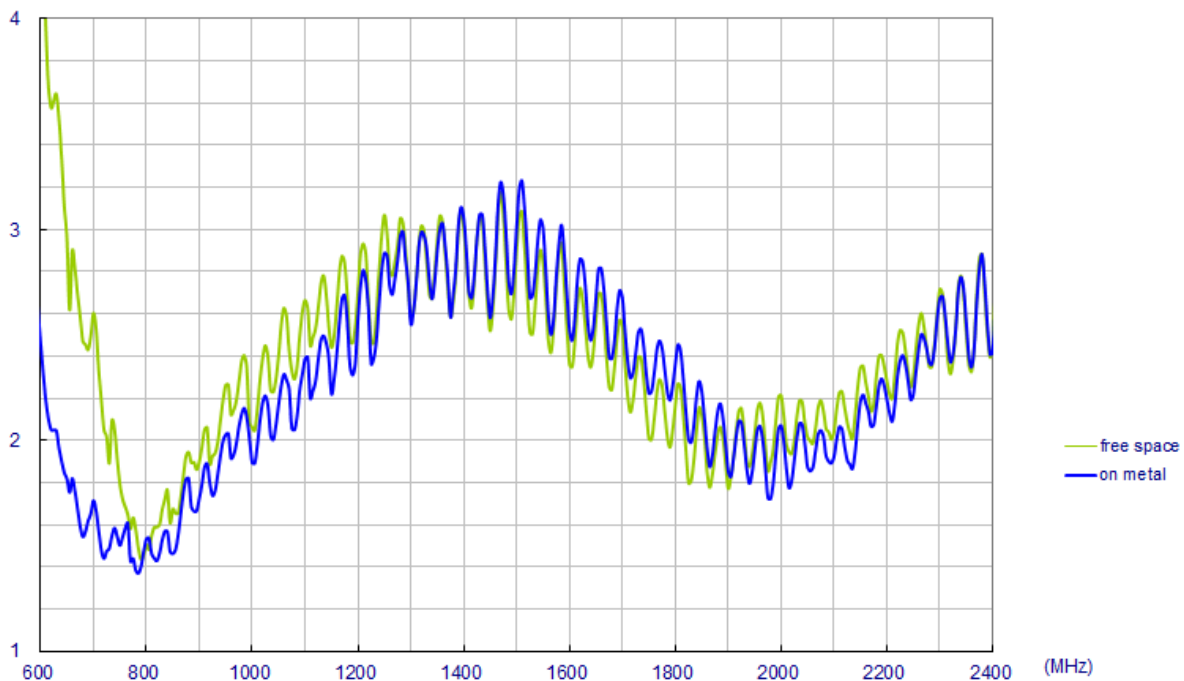

4.3. Cellular Antenna Efficiency

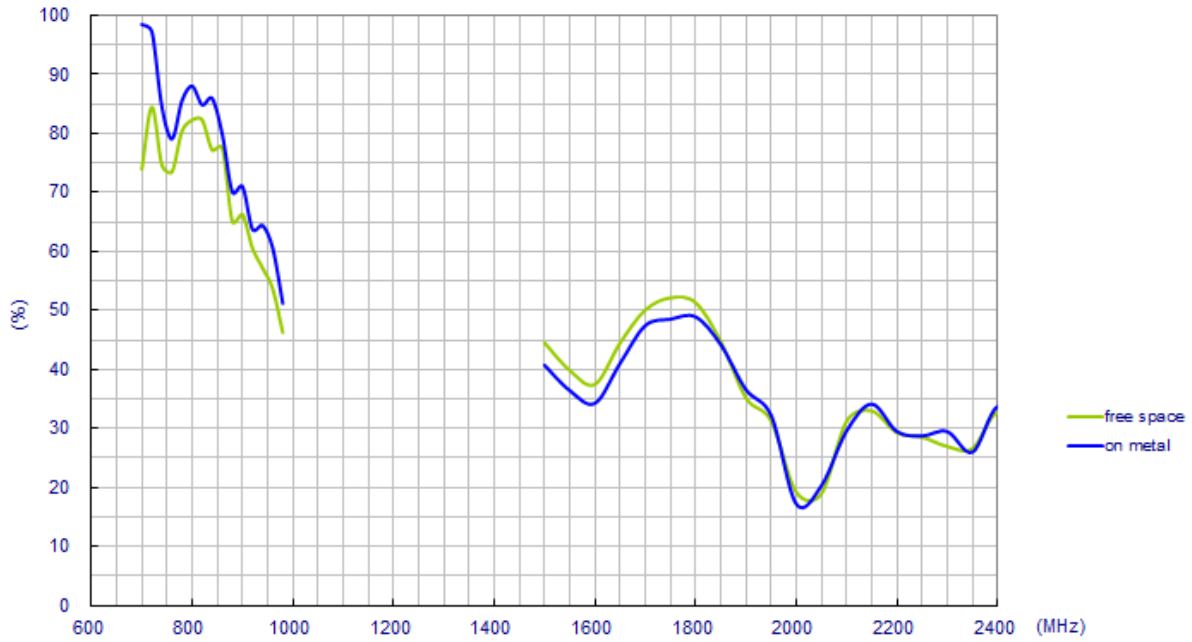

4.4. Cellular Antenna Peak Gain

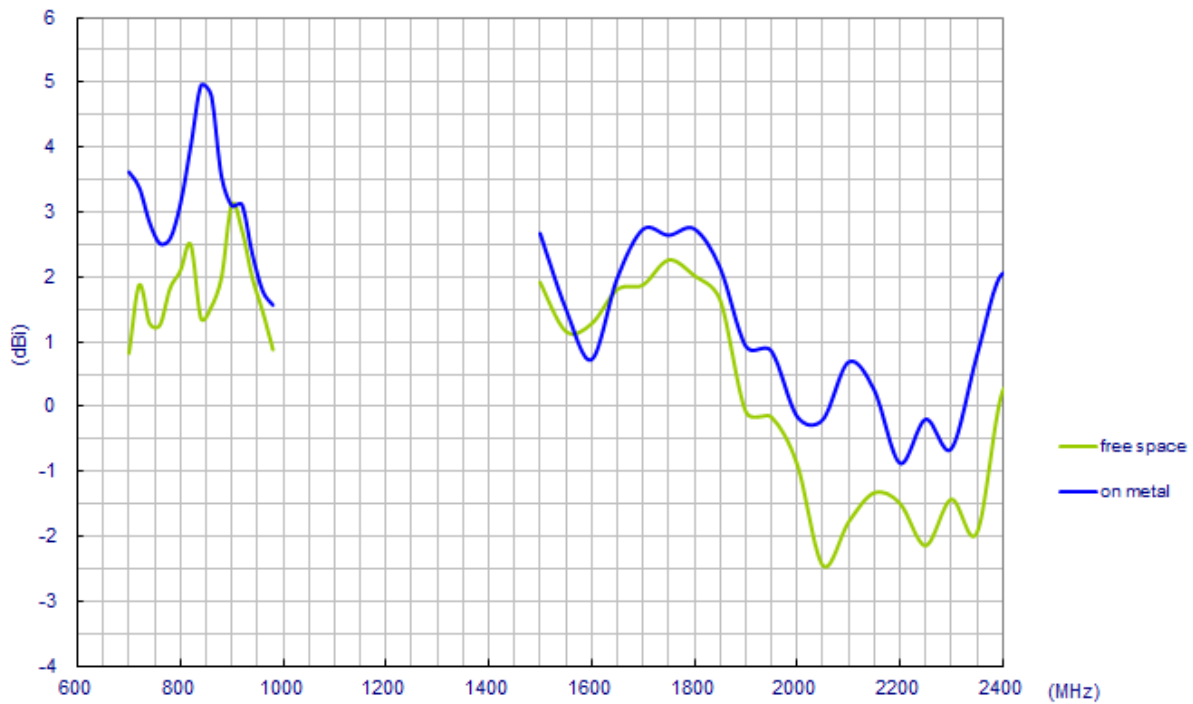

4.5. Cellular Antenna 3D Average Gain

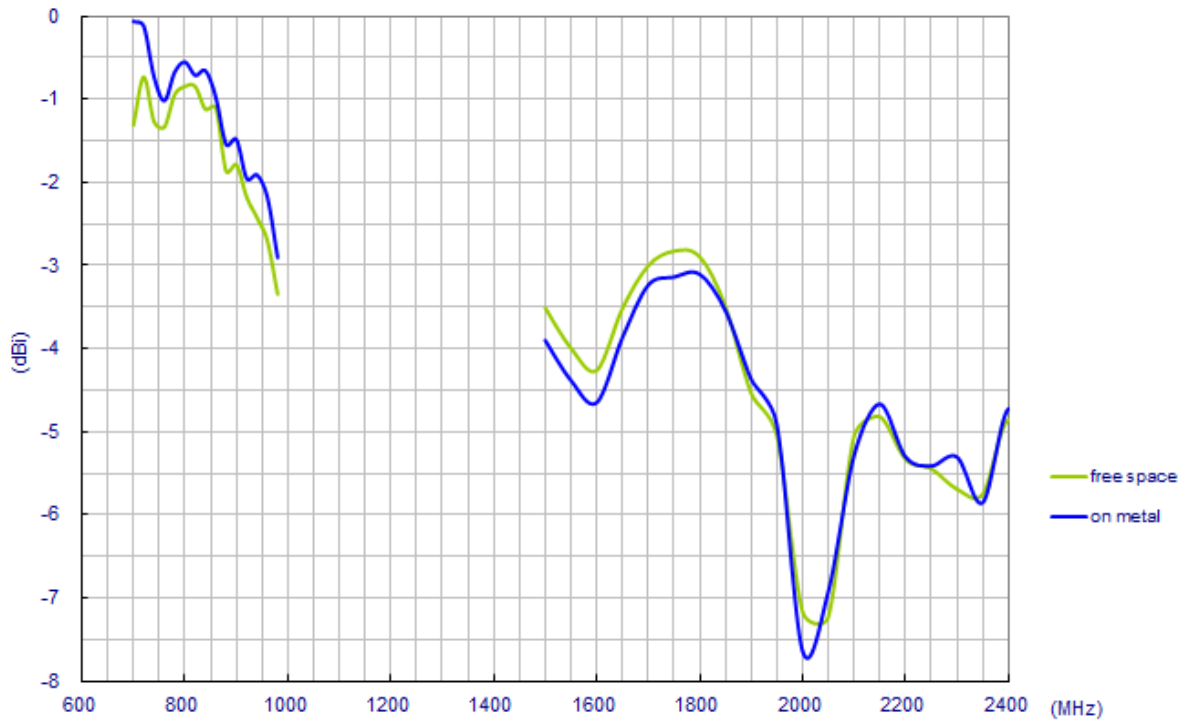

4.6. Cellular Antenna Radiation Pattern in Free Space

XY Plane

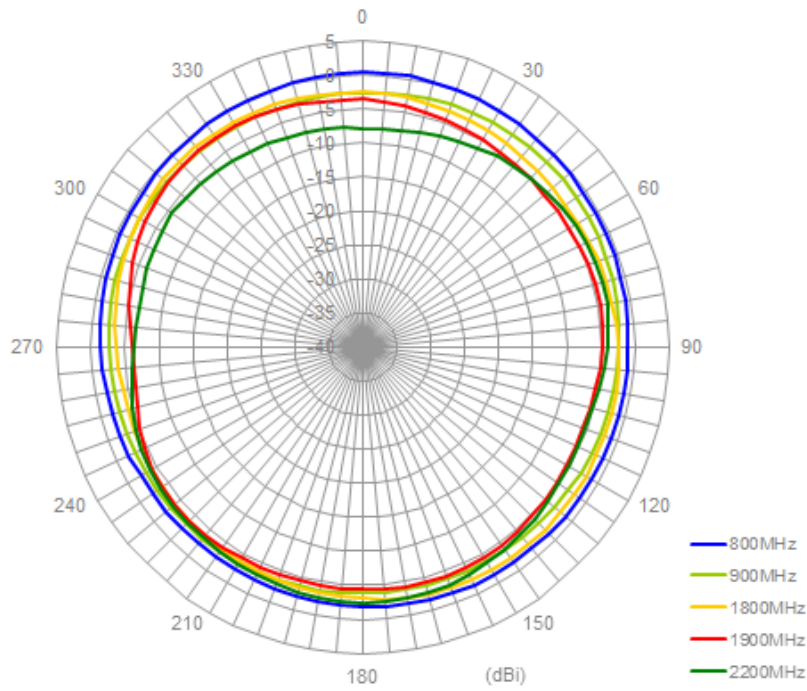

XZ Plane

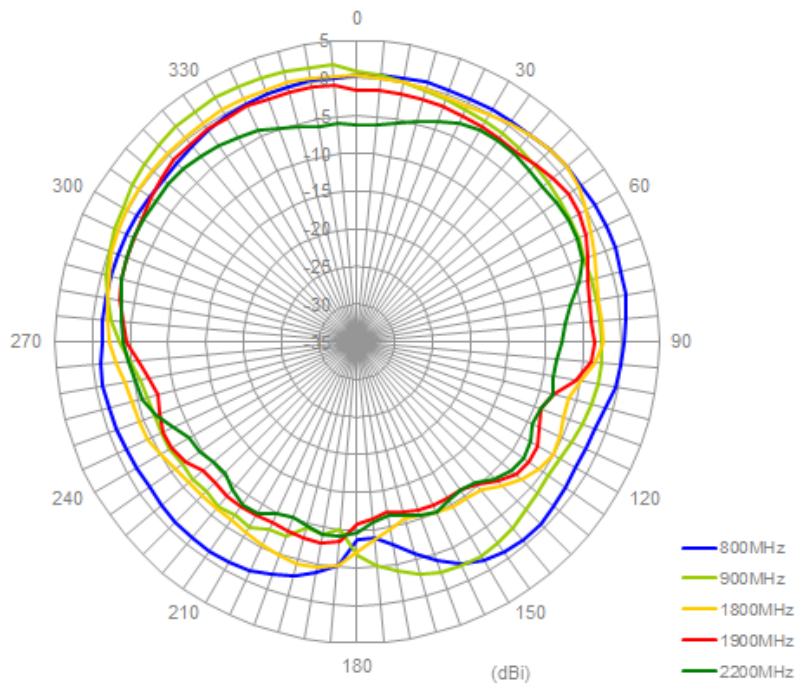

4.7. Cellular Antenna Radiation Pattern on Metal Ground Plane

XY Plane

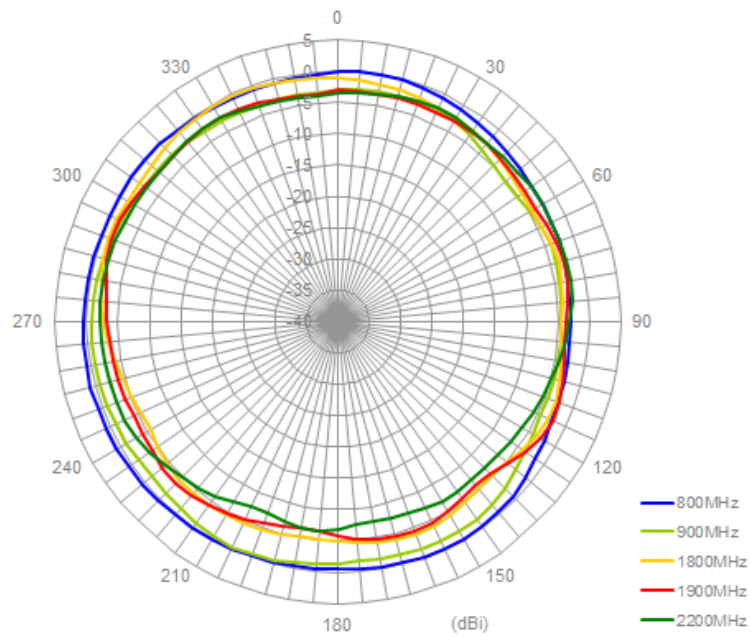

XZ Plane

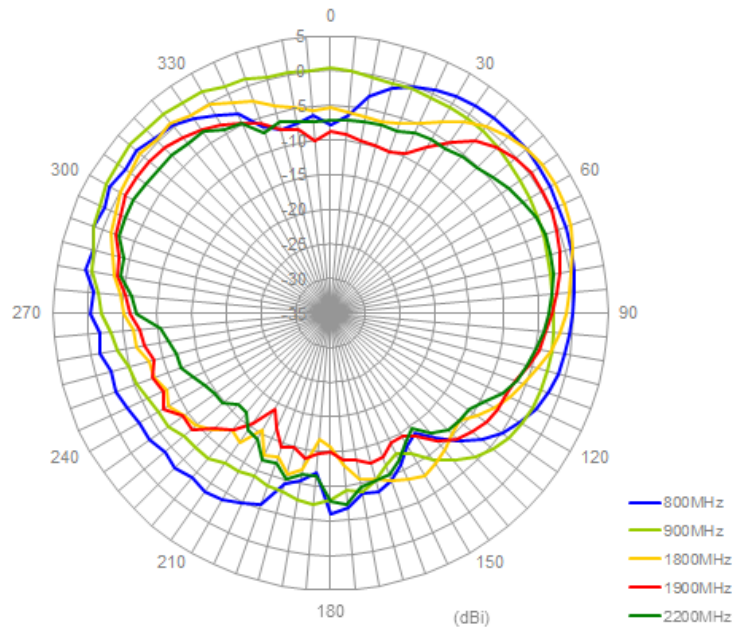

5. 2.4/5.8GHz Antenna Characteristics

5.1. Return Loss

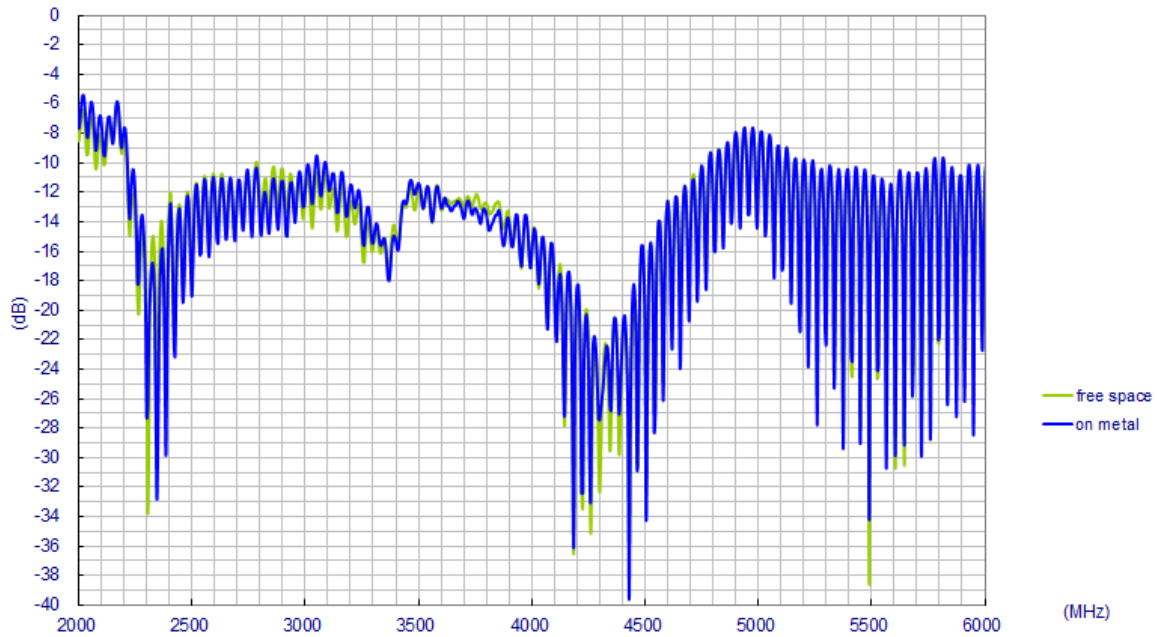

5.2. VSWR

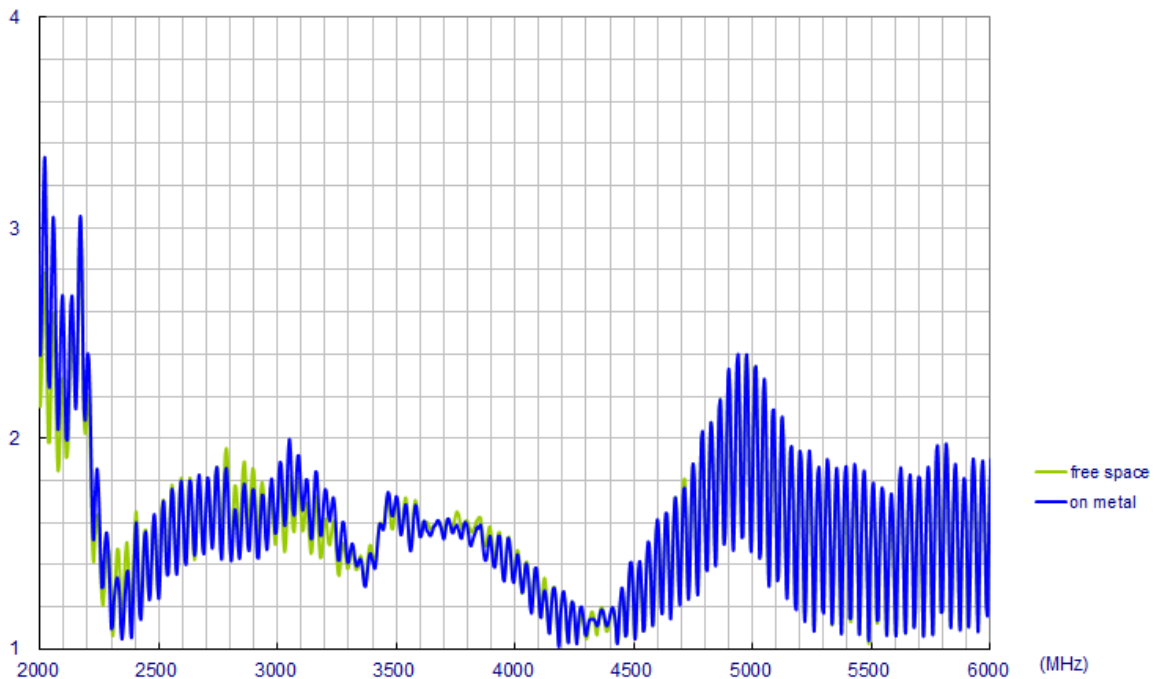

5.3. 2.4/5.8GHz Antenna Efficiency

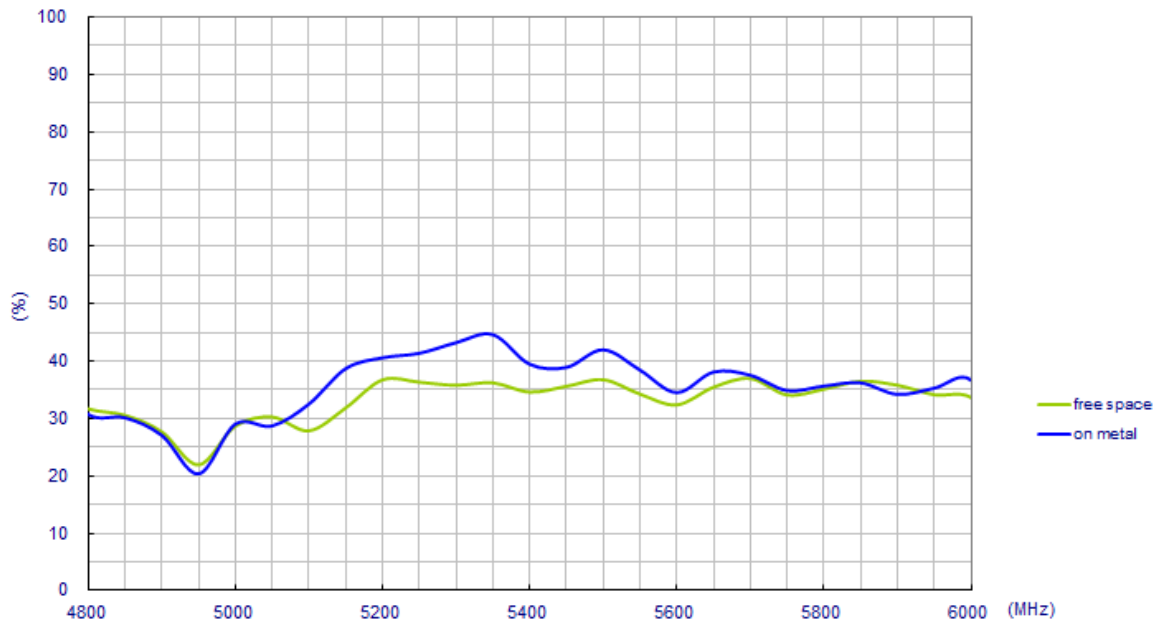
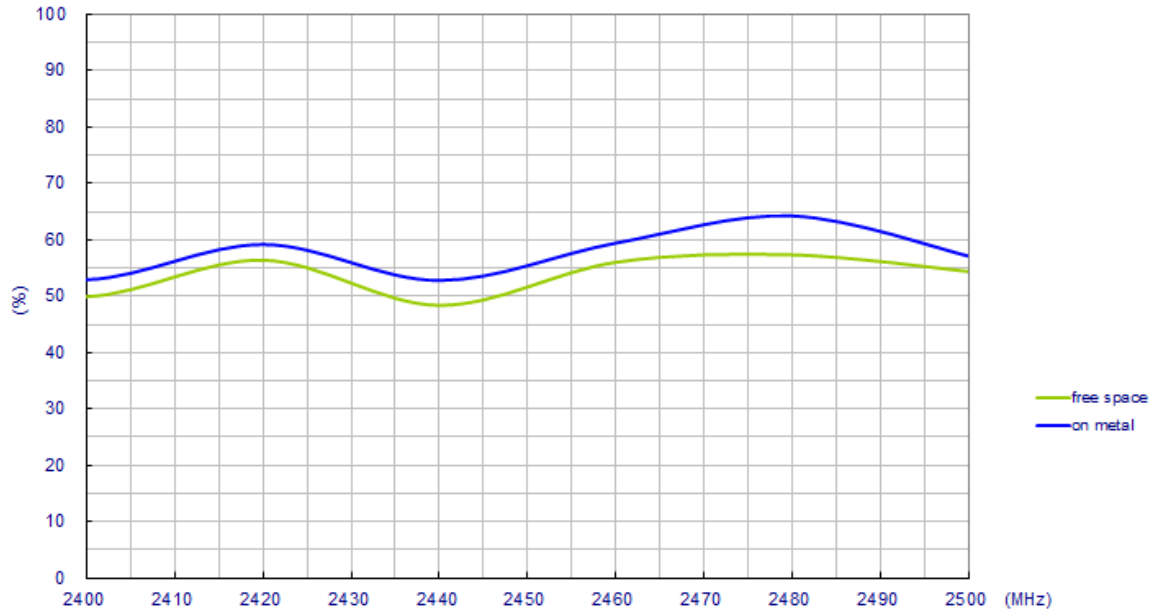

5.4. 2.4/5.8GHz Antenna Peak Gain

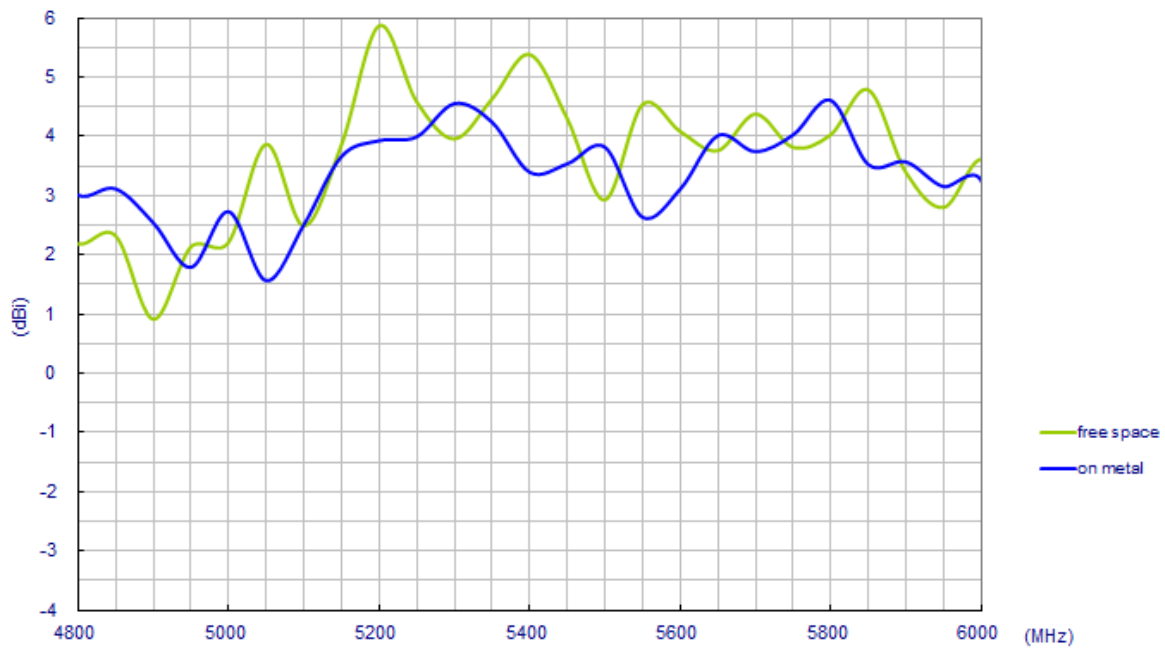
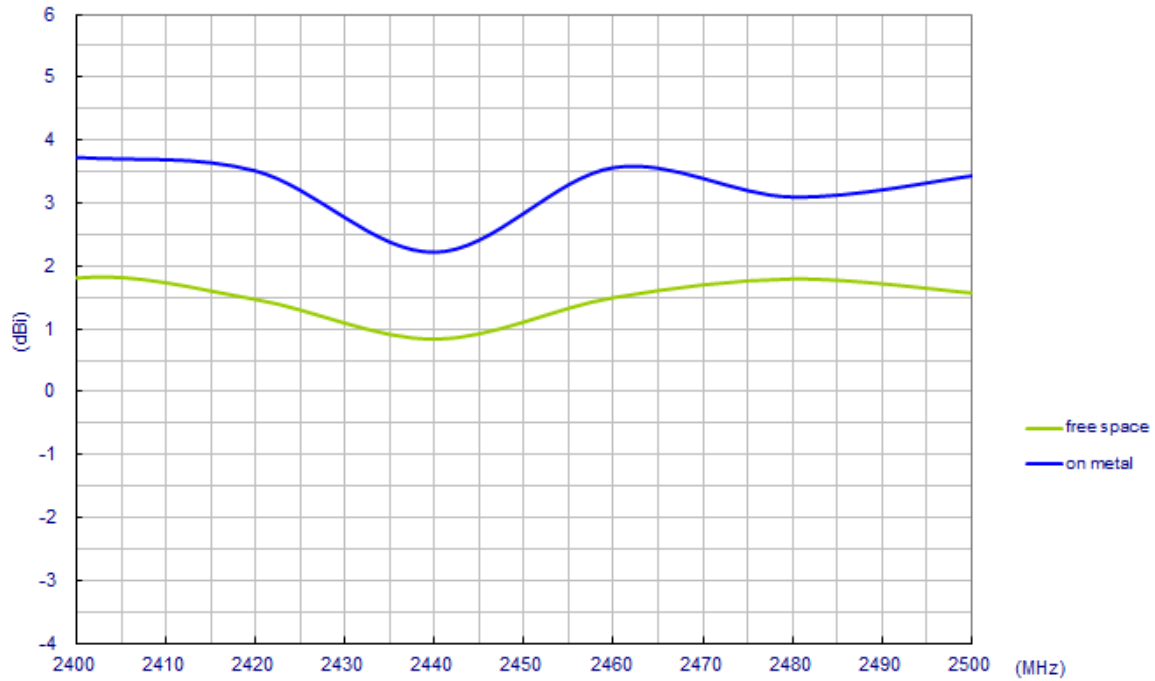

5.5. 2.4/5.8GHz Antenna 3D Average Gain

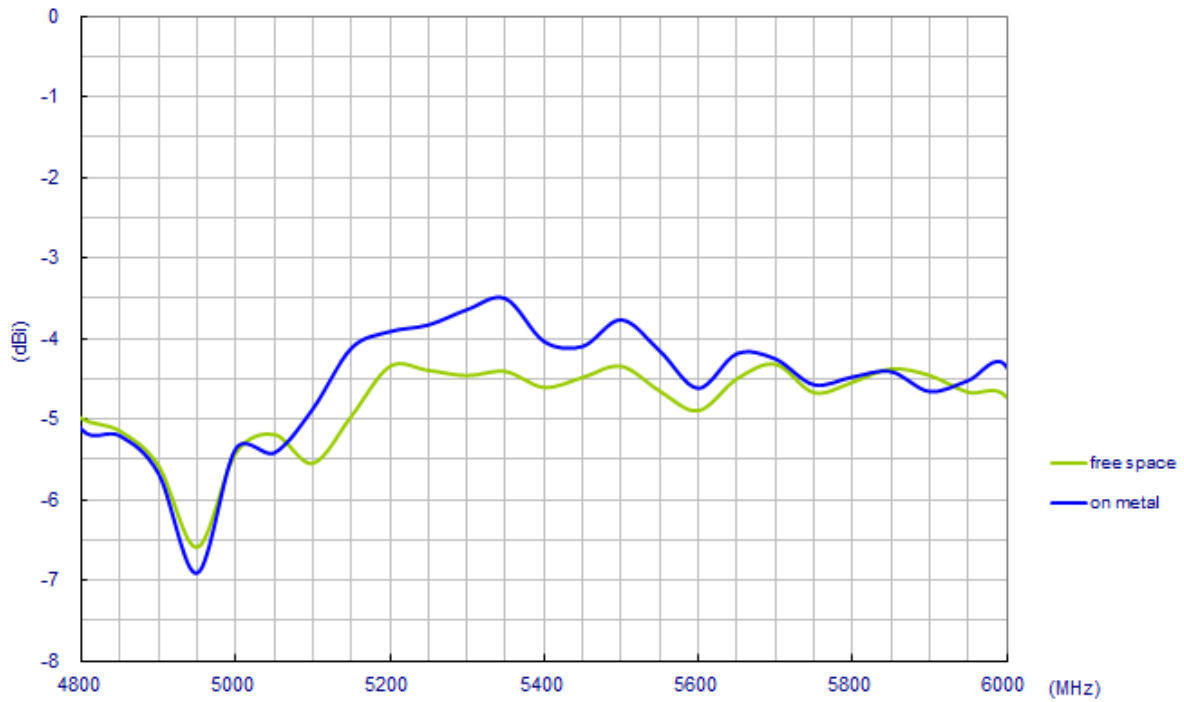
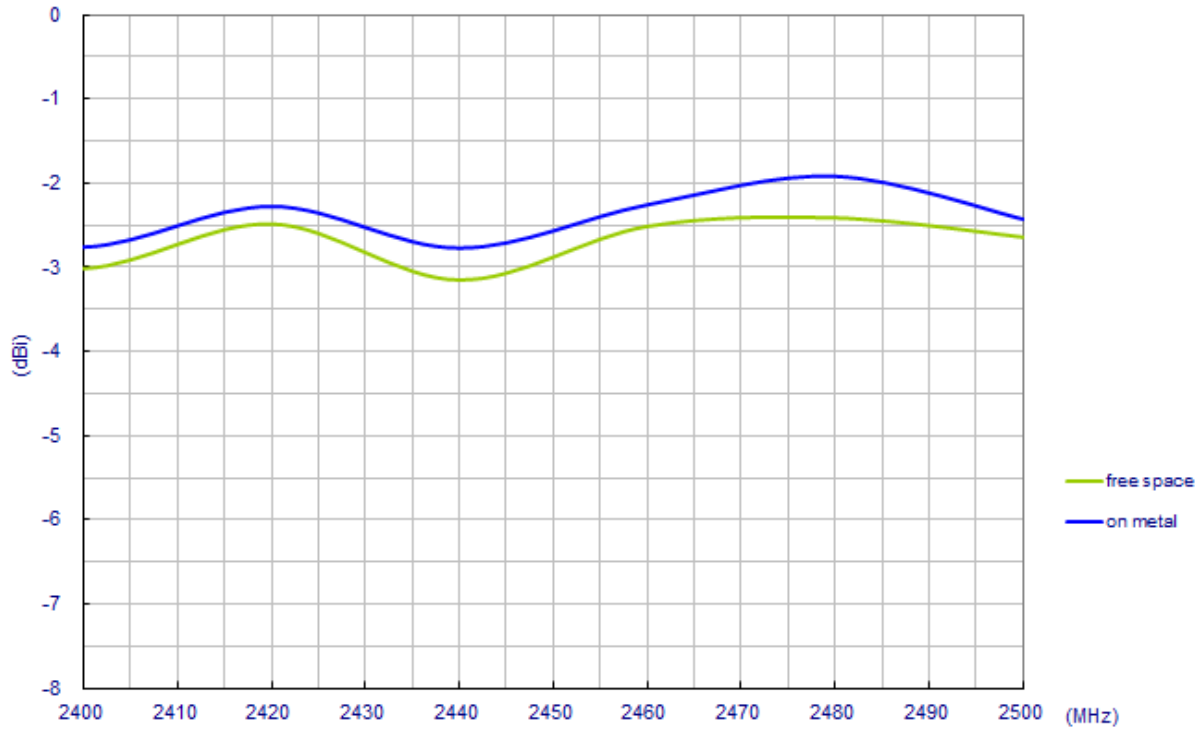

5.6. 2.4/5.8GHz Antenna Radiation Pattern in Free Space

XY Plane

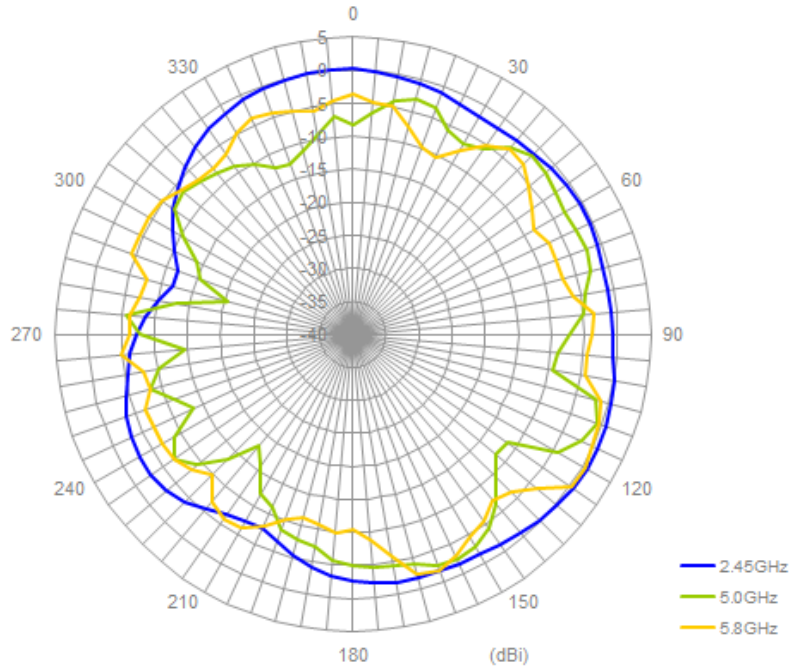

XZ Plane

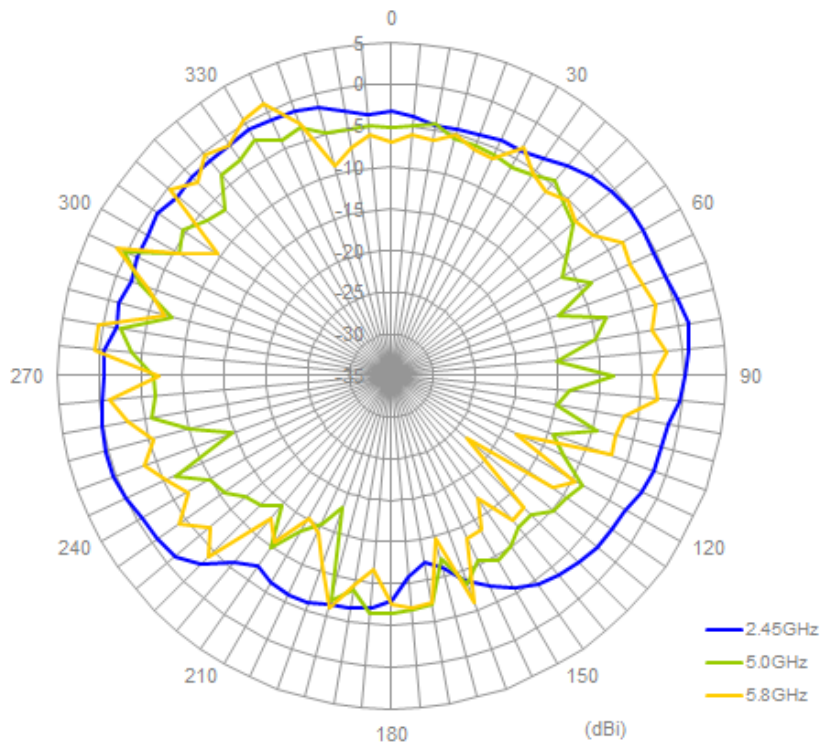

5.7. 2.4/5.8GHz Antenna Radiation Pattern on Metal Ground Plane

XY Plane

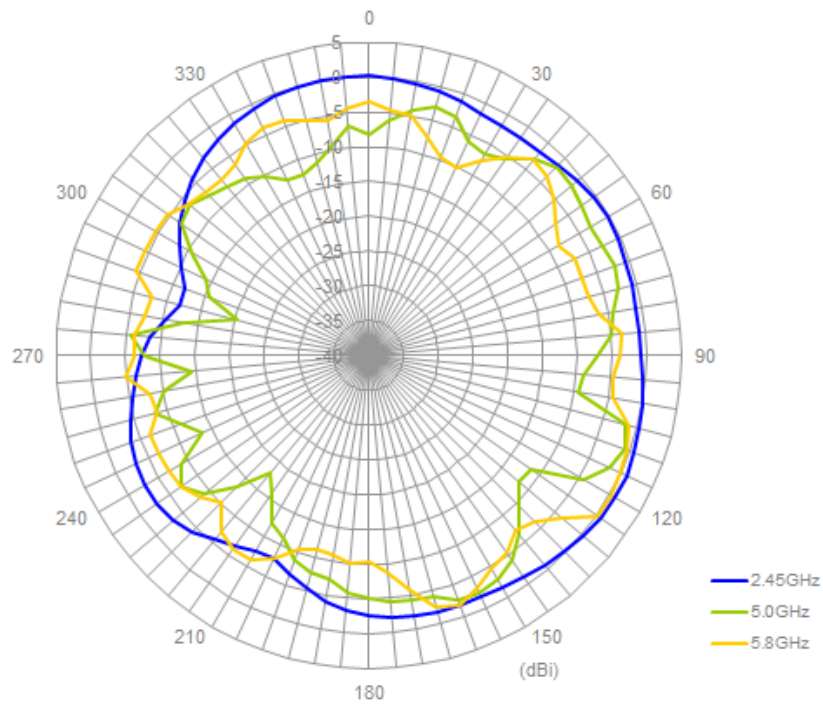

XZ Plane

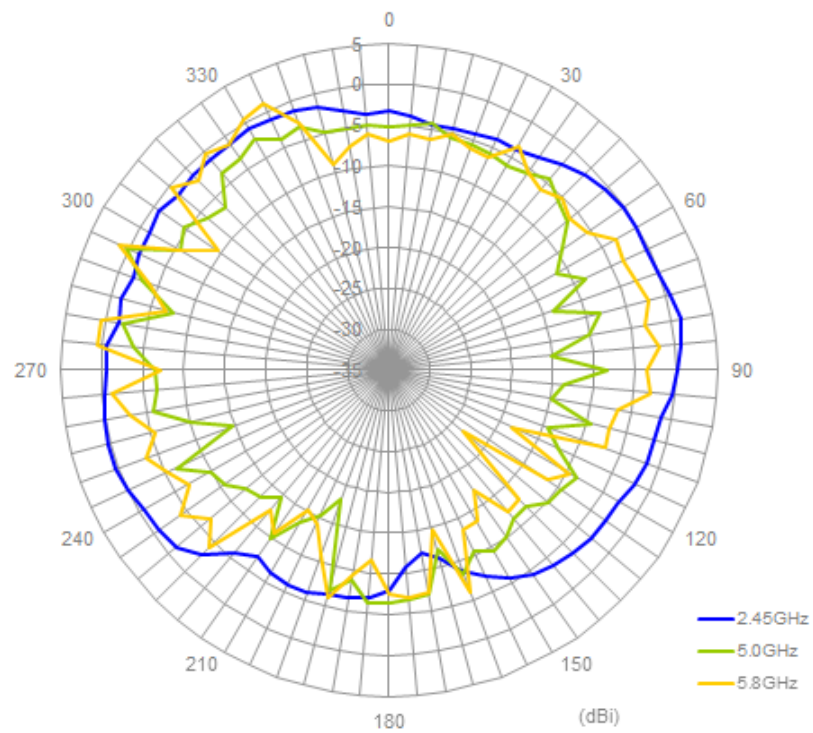

6. Mechanical Drawing

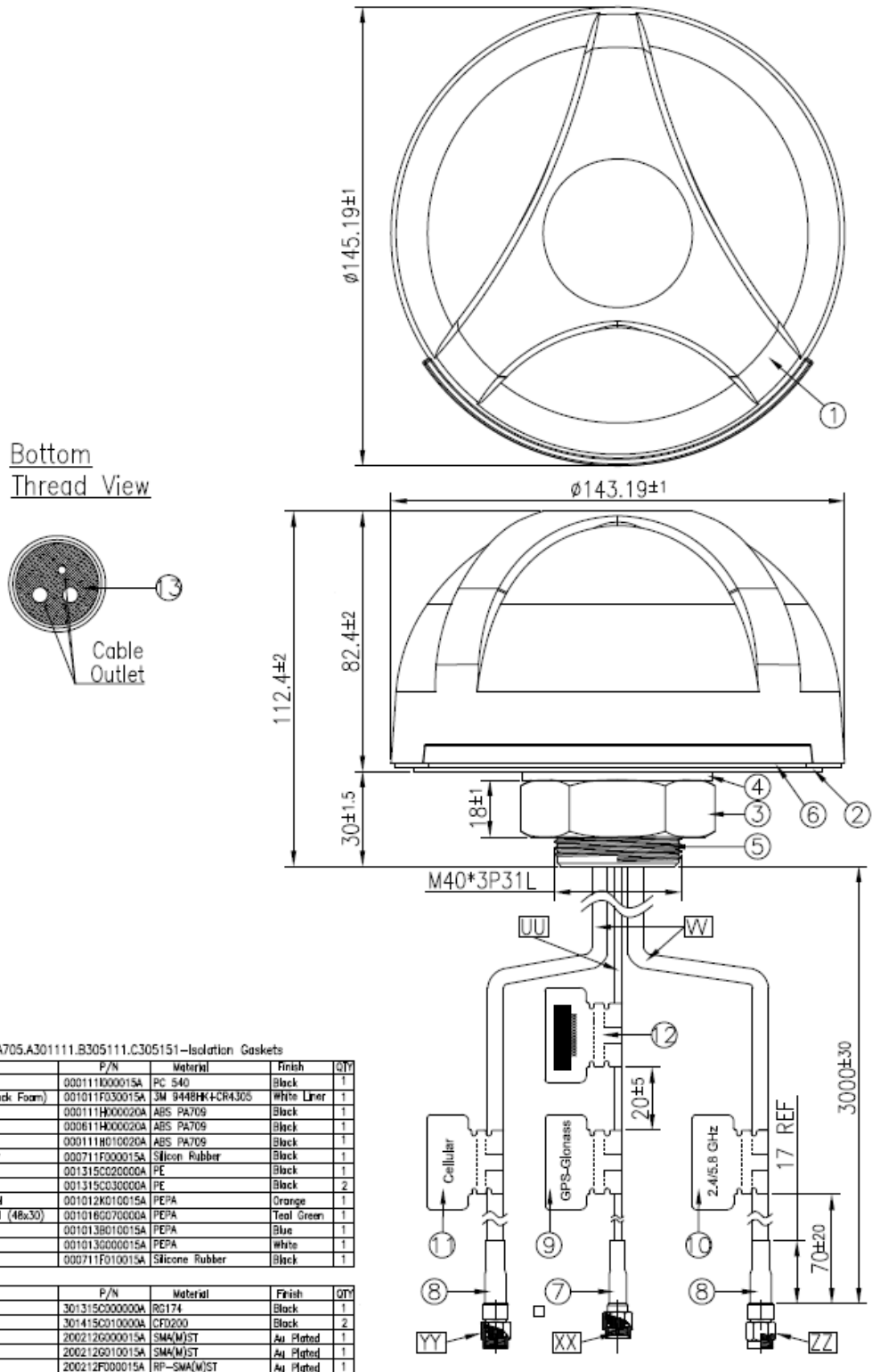

7. Packaging

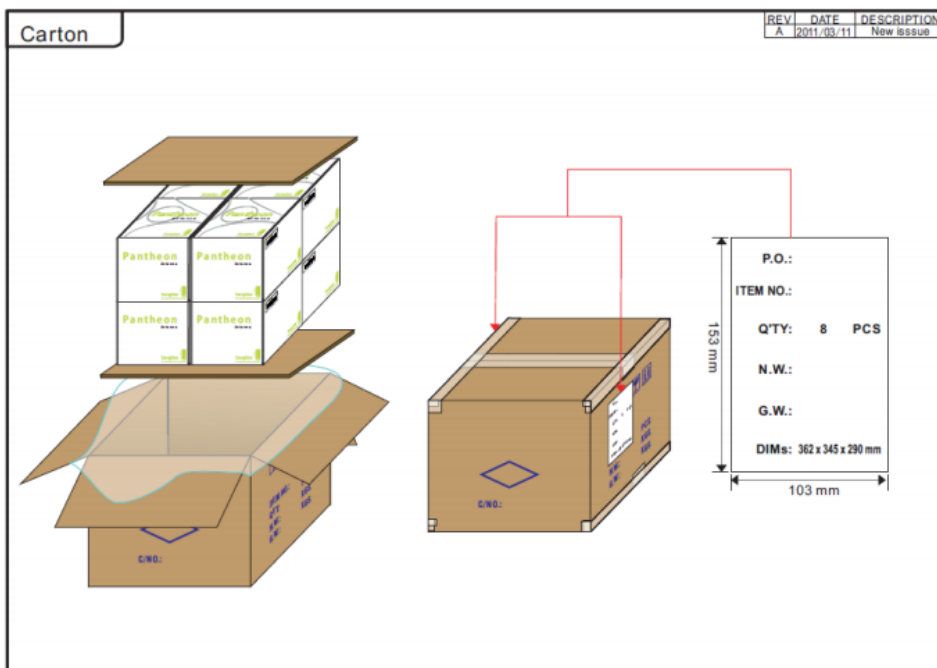
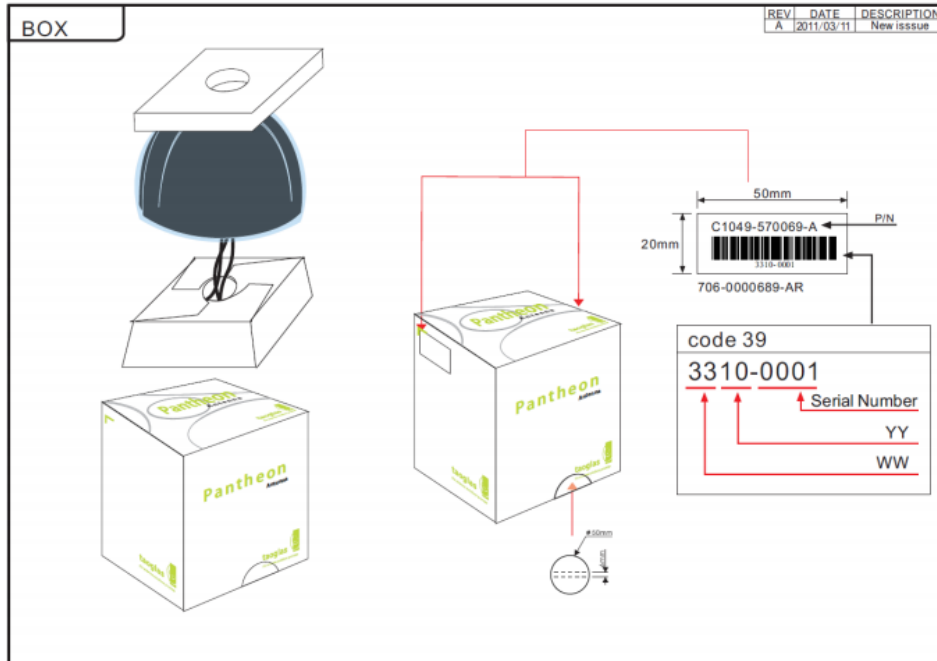

Taoglas makes no warranties based on the accuracy or completeness of the contents of this document and reserves the right to make changes to specifications and product descriptions at any time without notice. Taoglas reserves all rights to this document and the information contained herein.

Reproduction, use or disclosure to third parties without express permission is strictly prohibited.

Copyright © Taoglas Ltd.