

# FEATURES SELECTION GUIDE

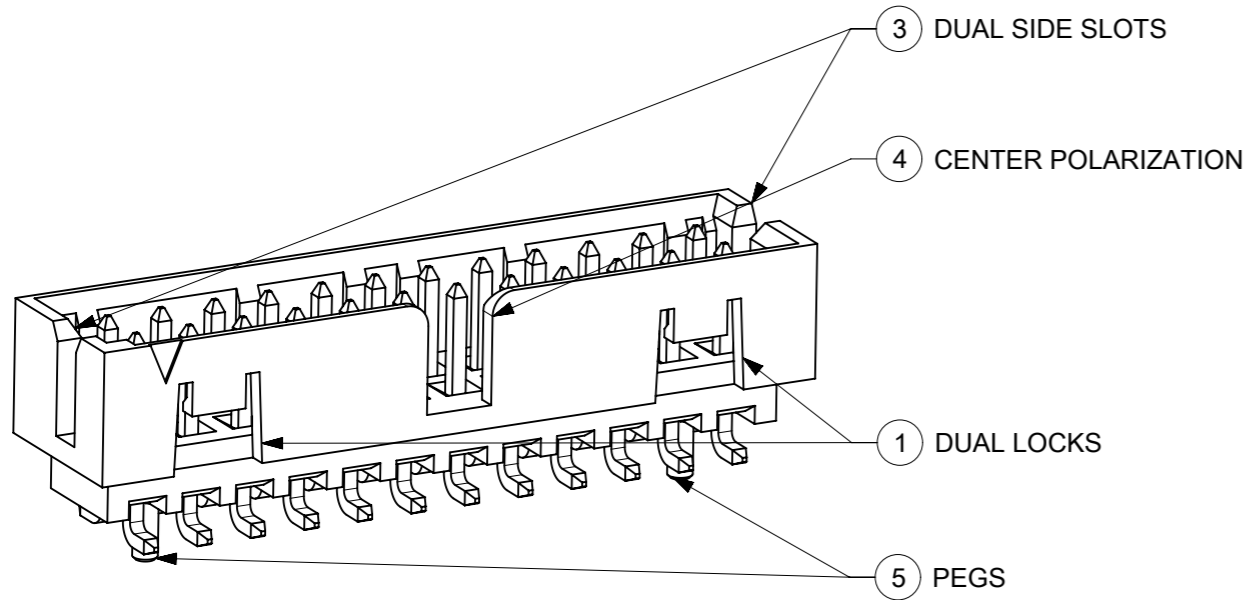

2 CENTER LOCK



3 DUAL SIDE SLOTS

4 CENTER POLARIZATION

1 DUAL LOCKS

5 PEGS

## PLATING MEASUREMENT

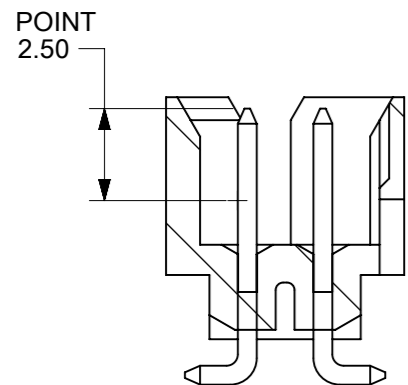

CIRCUIT SIZE	FEATURES					SHEET NO
	FRICTION LOCKS		DUAL SIDE SLOTS	CENTER POLARIZATION	PEGS	
	1 DUAL	2 CENTER				
4	N.A	N.A	YES	N.A	N.A	2 - 3
	N.A	YES	YES	N.A	N.A	
6	N.A	N.A	YES	N.A	N.A	4 - 5
	N.A	N.A	YES	N.A	YES	
	N.A	N.A	YES	YES	N.A	
	N.A	YES	YES	N.A	N.A	
	N.A	YES	YES	N.A	YES	
8 TO 12	N.A	N.A	YES	YES	YES	6 - 7
	N.A	N.A	YES	YES	N.A	
	N.A	YES	YES	N.A	YES	
14 TO 50	YES	N.A	YES	YES	N.A	8 - 11
	YES	N.A	YES	YES	YES	

THIS DRAWING CONTAINS INFORMATION THAT IS PROPRIETARY TO MOLEX ELECTRONIC TECHNOLOGIES, LLC AND SHOULD NOT BE USED WITHOUT WRITTEN PERMISSION

EC NO: 648718 DRWN: ABABUPS CHK'D: MRAMAKRISHNA REV APPR: MRAMAKRISHNA	2020/09/29	2020/11/09	2020/11/09	GENERAL TOLERANCES (UNLESS SPECIFIED)		DIMENSION UNITS	SCALE					
				MM	INCH	MM	NTS					
				4 PLACES	±	±	DRWN BY	DATE	MILLIGRID 2MM PITCH, SMT VERTICAL SHROUDED HEADER			
				3 PLACES	±	±	GMENARLY	2015/05/22				
				2 PLACES	± 0.2	±	CHK'D BY	DATE				
			1 PLACES	±	±	CGOH	2015/09/21	PRODUCT CUSTOMER DRAWING				
			0 PLACES	±	±	APPR BY	DATE					
						KHLIM	2015/09/22	SERIES	MATERIAL NUMBER	CUSTOMER		
						ANGULAR TOL = 3.0	DRAWING SIZE	THIRD ANGLE PROJECTION	87832	SEE TABLE	GENERAL MARKET	
						DRAFT WHERE APPLICABLE MUST REMAIN WITHIN DIMENSIONS	A3		DOCUMENT NUMBER	DOC TYPE	DOC PART	SHEET NUMBER
									SD-87832-0001	PSD	001	1 OF 13

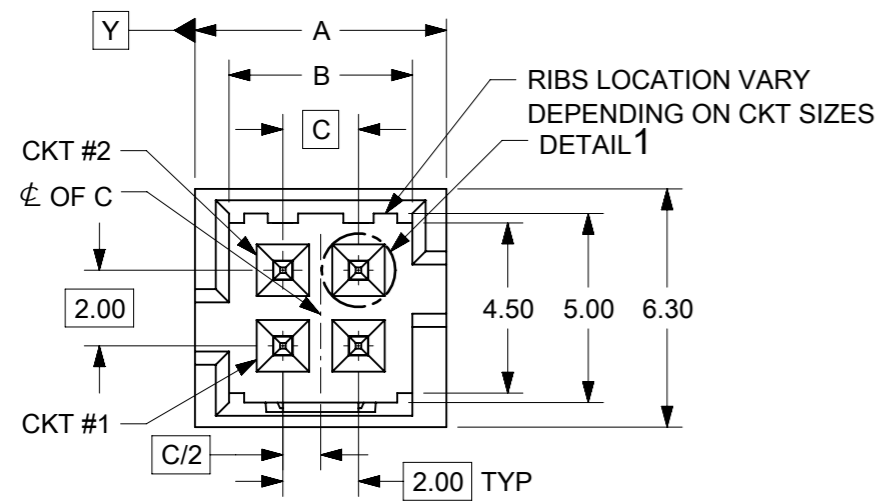

# 4 CIRCUITS

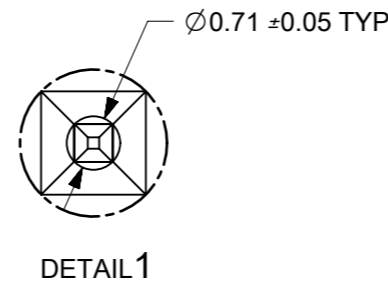

ISO VIEW OF HEADER WITH ONLY DUAL SLOTS

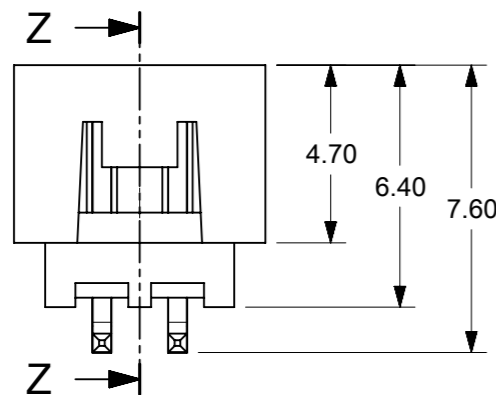

SECTION Z-Z

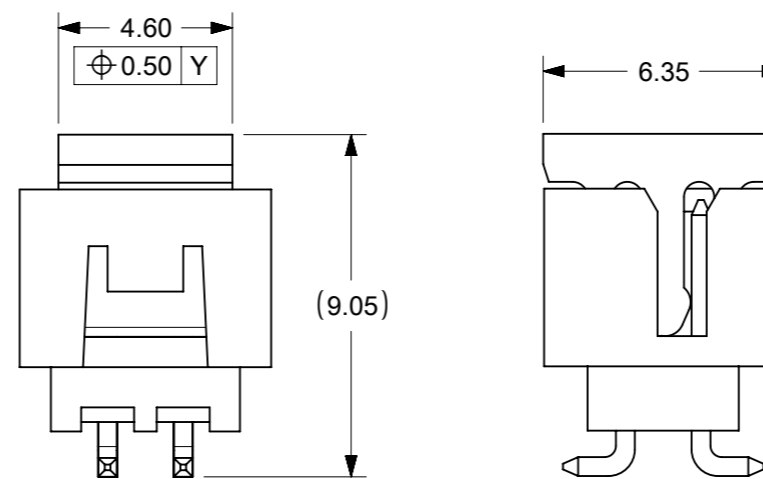
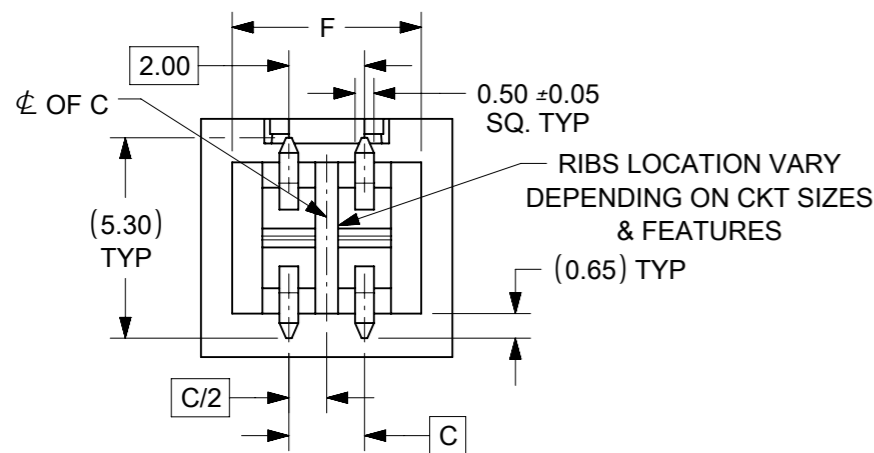

VIEW FOR HEADER WITH CAP

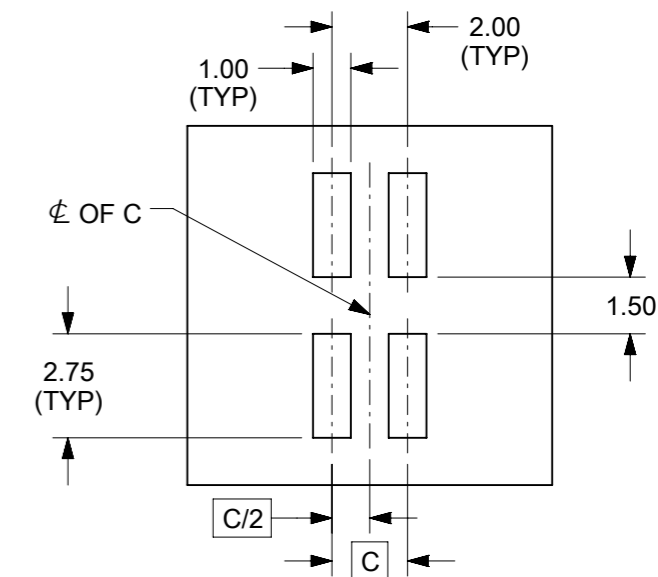

RECOMMENDED PCB LAYOUT

**NOTES:**

- MATERIALS:**  
HOUSING & CAP: 30% GF, NYLON, UL94V-0, COLOR: BLACK  
PIN: 0.50mm SQ. PHOSPHOR BRONZE
- FINISHES:** REFER TO PLATING OPTIONS
- PRODUCT SPECIFICATION:** PS-87831-027
- PACKAGING SPECIFICATION:** SEE PACKAGING SPECS TABLE ON SHEET 12
- MATES WITH:** A. MOLEX CRIMP RECEPTACLE HOUSING: 51110 SERIES AND CRIMP TERMINAL: 50394 SERIES  
B. MOLEX 2mm MILLIGRID DUAL ROW IDT: 87568 SERIES  
C. MOLEX 2mm MILLIGRID DUAL ROW RECEPTACLE: 79107 (GOLD PLATED), 78787 (TIN PLATED)
- COPLANARITY IS TO BE MEASURED BY RESTING THE SOLDER TAIL ON A GAUGE SURFACE
- BEND DEPRESSION ON SMT TAIL IS ACCEPTABLE SO LONG AS IT DOES NOT AFFECT THE OVERALL COPLANARITY
- TOP SURFACE OF CAP TO BE FLAT FOR THE PURPOSE OF PICK & PLACE BY VACUUM SUCTION NOZZLE

THIS DRAWING CONTAINS INFORMATION THAT IS PROPRIETARY TO MOLEX ELECTRONIC TECHNOLOGIES, LLC AND SHOULD NOT BE USED WITHOUT WRITTEN PERMISSION

EC NO: 648718 DRWN: ABABUPS CHKD: MRAMAKRISHNA APPR: MRAMAKRISHNA	2020/09/29	GENERAL TOLERANCES (UNLESS SPECIFIED)		DIMENSION UNITS		SCALE							
	2020/11/09	MM	INCH	MM	NTS	DRWN BY						DATE	
	2020/11/09	4 PLACES	±	±	GMENARLY		2015/05/22		MILLIGRID 2MM PITCH, SMT VERTICAL SHROUDED HEADER				
		3 PLACES	±	±	CHK'D BY		DATE						
		2 PLACES	±	0.2	±	CGOH		2015/09/21					
	1 PLACES	±	±	APPR BY		DATE		PRODUCT CUSTOMER DRAWING					
	0 PLACES	±	±	KHLIM		2015/09/22							
		ANGULAR TOL = 3.0		DRAWING SIZE		THIRD ANGLE PROJECTION		SERIES	MATERIAL NUMBER	CUSTOMER			
		DRAFT WHERE APPLICABLE MUST REMAIN WITHIN DIMENSIONS		A3				87832	SEE TABLE	GENERAL MARKET			
								DOCUMENT NUMBER		DOC TYPE	DOC PART	SHEET NUMBER	
								SD-87832-0001		PSD	001	2 OF 13	

4 CIRCUITS

CKT SIZE	ASSY P/N WITHOUT CAP IN TUBE	ASSY P/N WITH CAP IN TUBE	ASSY P/N WITH CAP IN T&R	T&R OPTIONS (SEE SHEET 12)	PLATING OPTIONS	FRICTION LOCKS		DUAL SIDE SLOTS	CENTER POLARIZATION	PEGS	DIMENSION							
						DUAL	CENTER				A	B	C	D	E	F	G (COPLAN)	H
4	87832-0460	87832-0462	87832-5162	1	1	N.A	N.A	YES	N.A	N.A	6.65	4.85	2.00	N.A	N.A	5.00	0.10	3.60±0.20
	87832-0420	87832-0422	87832-5122	1	2													
	87832-0421	87832-0423	87832-5123	1	3													
	87832-0470	87832-0472	87832-5172	1	4	N.A	YES	YES	N.A	N.A							0.10	
	87832-0410	87832-0408	87832-0406	1	2													
			87832-5106	2	2													
	87832-0411	87832-0409	87832-0407	1	3													
87832-0404	N.A	N.A	N.A	2						0.10								

**PLATING OPTIONS:**

- 1 - 0.05-0.13µm/2-5µin GOLD IN CONTACT AREA AND 1.88µm/75µin MIN. MATTE TIN IN SOLDER TAIL AREA OVER 1.27µm/50µin MIN. NICKEL OVERALL.
- 2 - 0.38µm/15µin MIN. GOLD IN CONTACT AREA AND 1.88µm/75µin MIN. MATTE TIN IN SOLDER TAIL AREA OVER 1.27µm/50µin MIN. NICKEL OVERALL.
- 3 - 0.76µm/30µin MIN. GOLD IN CONTACT AREA AND 1.88µm/75µin MIN. MATTE TIN IN SOLDER TAIL AREA OVER 1.27µm/50µin MIN. NICKEL OVERALL.
- 4 - 2.50µm/100µin MIN. MATTE TIN OVER 1.25µm/50µin MIN. NICKEL OVERALL.

THIS DRAWING CONTAINS INFORMATION THAT IS PROPRIETARY TO MOLEX ELECTRONIC TECHNOLOGIES, LLC AND SHOULD NOT BE USED WITHOUT WRITTEN PERMISSION

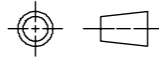
EC NO: 648718 DRWN: ABABUPS CHKD: MRAMAKRISHNA REV APPR: MRAMAKRISHNA	2020/09/29	2020/11/09	2020/11/09	GENERAL TOLERANCES (UNLESS SPECIFIED)		DIMENSION UNITS	SCALE				
				MM	INCH	MM	NTS				
				4 PLACES ±	±	DRWN BY	DATE	MILLIGRID 2MM PITCH, SMT VERTICAL SHROUDED HEADER			
				3 PLACES ±	±	GMENARLY	2015/05/22				
				2 PLACES ± 0.2	±	CHK'D BY	DATE				
				1 PLACES ±	±	CGOH	2015/09/21	PRODUCT CUSTOMER DRAWING			
			0 PLACES ±	±	APPR BY	DATE					
					KHLIM	2015/09/22	SERIES	MATERIAL NUMBER	CUSTOMER		
					ANGULAR TOL = 3.0	DRAWING SIZE	THIRD ANGLE PROJECTION	87832	SEE TABLE	GENERAL MARKET	
					DRAFT WHERE APPLICABLE MUST REMAIN WITHIN DIMENSIONS	A3		DOCUMENT NUMBER	DOC TYPE	DOC PART	SHEET NUMBER
								SD-87832-0001	PSD	001	3 OF 13

RELEASE STATUS	P1	RELEASE DATE	2020/11/09	04:05:48
----------------	----	--------------	------------	----------

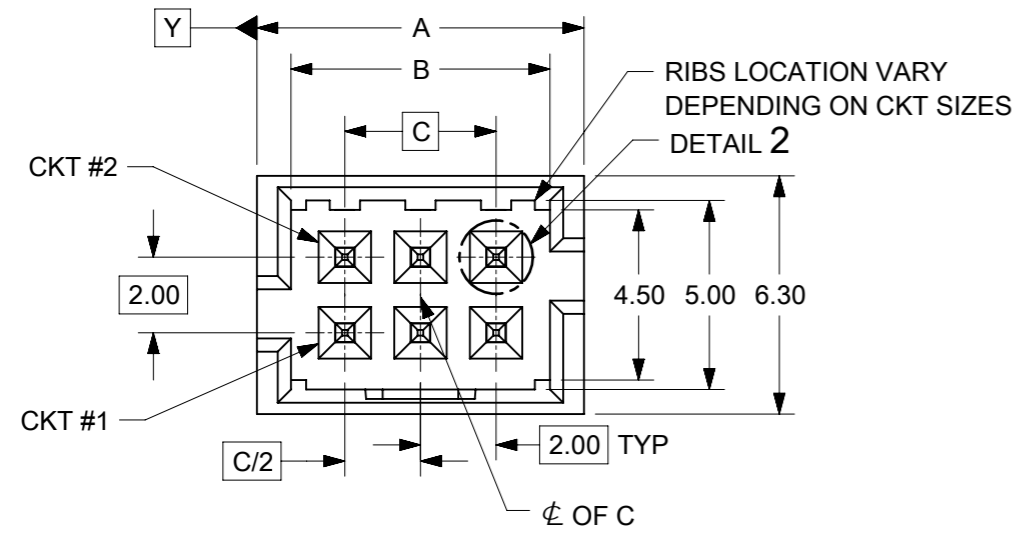

6 CIRCUITS

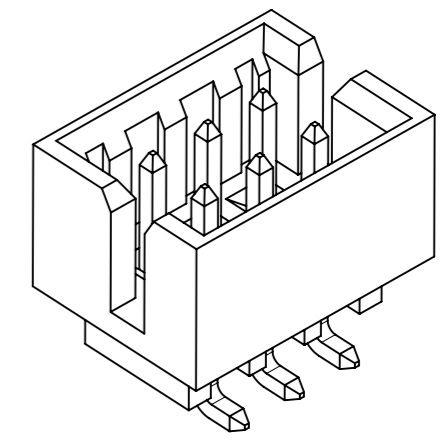
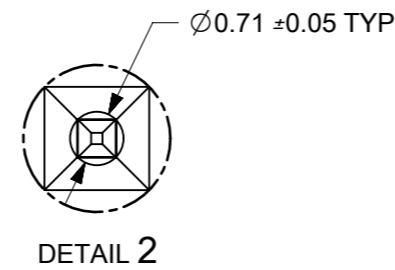

VIEW FOR HEADER WITH ONLY DUAL SLOTS

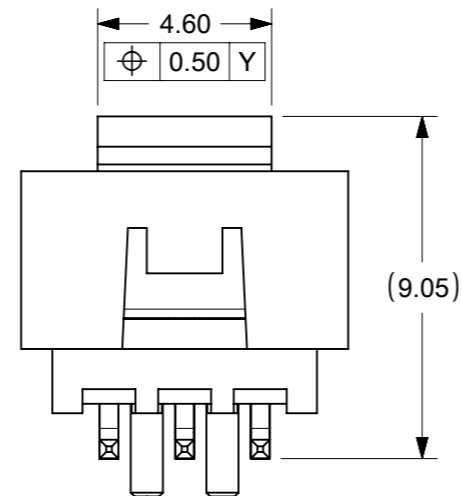
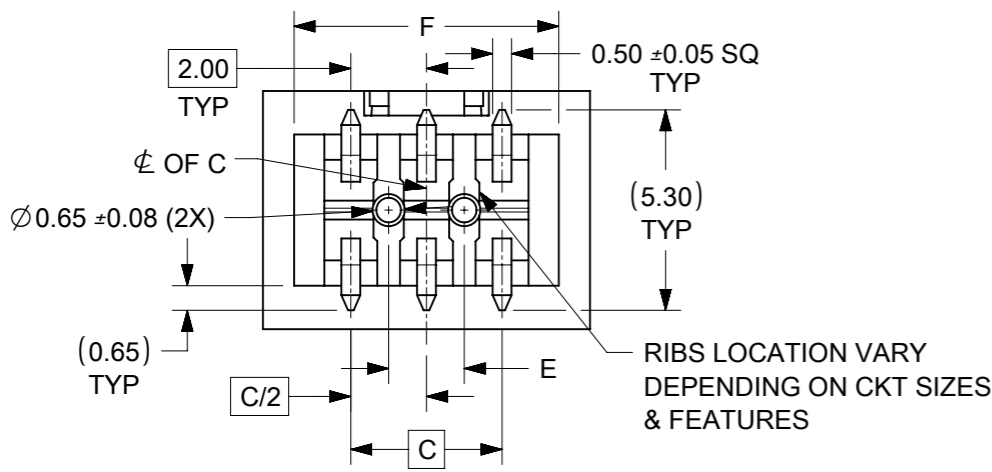
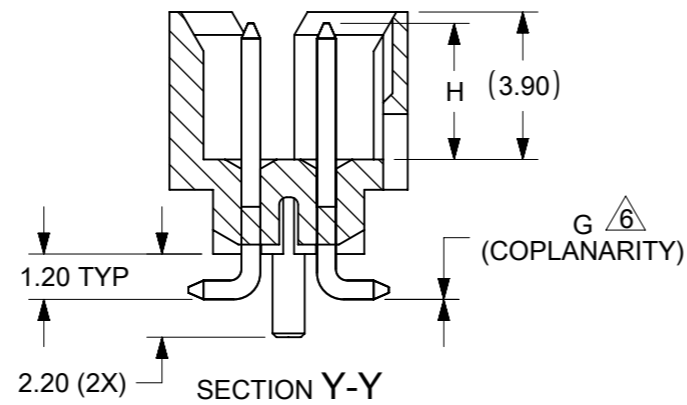

VIEW FOR HEADER WITH CAP

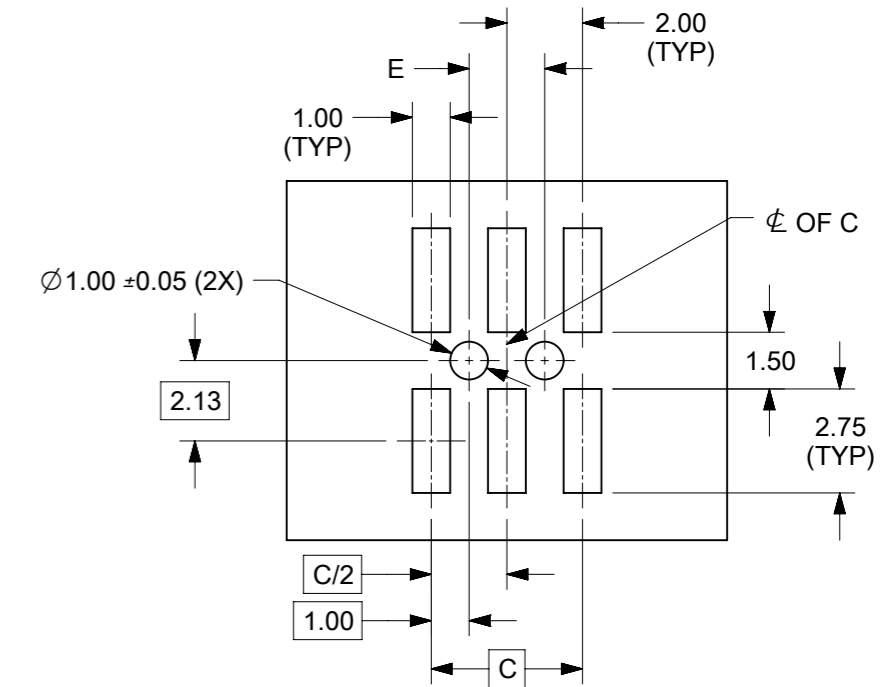
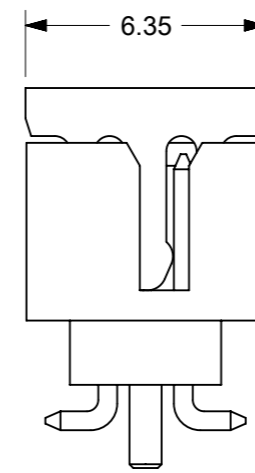

RECOMMENDED PCB LAYOUT

- NOTES:
- MATERIALS:  
HOUSING & CAP: 30% GF, NYLON, UL94V-0, COLOR: BLACK  
PIN: 0.50mm SQ. PHOSPHOR BRONZE
  - FINISHES: REFER TO PLATING OPTIONS
  - PRODUCT SPECIFICATION: PS-87831-027
  - PACKAGING SPECIFICATION: SEE PACKAGING SPECS TABLE ON SHEET 12
  - MATES WITH: A. MOLEX CRIMP RECEPTACLE HOUSING: 51110 SERIES AND CRIMP TERMINAL: 50394 SERIES  
B. MOLEX 2mm MILLIGRID DUAL ROW IDT: 87568 SERIES  
C. MOLEX 2mm MILLIGRID DUAL ROW RECEPTACLE: 79107 (GOLD PLATED), 78787 (TIN PLATED)
- 6 COPLANARITY IS TO BE MEASURED BY RESTING THE SOLDER TAIL ON A GAUGE SURFACE
7. BEND DEPRESSION ON SMT TAIL IS ACCEPTABLE SO LONG AS IT DOES NOT AFFECT THE OVERALL COPLANARITY
8. TOP SURFACE OF CAP TO BE FLAT FOR THE PURPOSE OF PICK & PLACE BY VACUUM SUCTION NOZZLE

THIS DRAWING CONTAINS INFORMATION THAT IS PROPRIETARY TO MOLEX ELECTRONIC TECHNOLOGIES, LLC AND SHOULD NOT BE USED WITHOUT WRITTEN PERMISSION

EC NO: 648718 DRWN: ABABUPS CHKD: MRAMAKRISHNA APPR: MRAMAKRISHNA	2020/09/29	GENERAL TOLERANCES (UNLESS SPECIFIED)		DIMENSION UNITS		SCALE							
	2020/11/09	MM	INCH	MM	NTS	DRWN BY						DATE	
	2020/11/09	4 PLACES	±	±	GMENARLY		2015/05/22		MILLIGRID 2MM PITCH, SMT VERTICAL SHROUDED HEADER				
		3 PLACES	±	±	CHK'D BY		DATE						
		2 PLACES	±	0.2	±	CGOH		2015/09/21		PRODUCT CUSTOMER DRAWING			
	1 PLACES	±	±	APPR BY		DATE							
	0 PLACES	±	±	KHLIM		2015/09/22		SERIES		MATERIAL NUMBER		CUSTOMER	
	ANGULAR TOL = 3.0		DRAWING SIZE		THIRD ANGLE PROJECTION		87832		SEE TABLE		GENERAL MARKET		
DRAFT WHERE APPLICABLE MUST REMAIN WITHIN DIMENSIONS		A3				DOCUMENT NUMBER		DOC TYPE		DOC PART		SHEET NUMBER	
A15		REV		SD-87832-0001		PSD		001		4 OF 13			

# 6 CIRCUITS

CKT SIZE	ASSY P/N WITHOUT CAP IN TUBE	ASSY P/N WITH CAP IN TUBE	ASSY P/N WITH CAP IN T&R	ASSY P/N WITHOUT CAP IN T&R	T&R OPTIONS (SEE SHEET 12)	PLATING OPTIONS	FRICTION LOCKS		DUAL SIDE SLOTS	CENTER POLARIZATION	PEGS	DIMENSION							
							DUAL	CENTER				A	B	C	D	E	F	G (COPLAN)	H
6	87832-0660	87832-0662	87832-5262		1	1	N.A	N.A	YES	N.A	YES	8.65	6.85	4.00	N.A	2.00	7.00	0.10	3.60±0.20
	87832-0620	87832-0622	87832-5222	87832-5230 (A14)	1	2													
	87832-0621	87832-0623	87832-5223		1	3													
	87832-0670	87832-0672	87832-5272		1	4	N.A	N.A	YES	N.A	N.A							0.10	3.60±0.20
	87832-0612	87832-0616	87832-0614		1	2													
	87832-0613	87832-0617	87832-0615		1	3	N.A	YES	YES	N.A	N.A							0.10	3.60±0.15
	87832-0624	87832-0626	87832-0628		1	2													
	87832-0625	87832-0627	87832-0629		1	3	N.A	YES	YES	N.A	YES							0.10	3.60±0.20
	87832-0610	87832-0608	87832-0606		1	2													
	87832-0611	87832-0609	87832-0607		1	3	N.A	YES	YES	N.A	YES							0.10	3.60±0.20
87832-0604	N.A	N.A		N.A	2														

**PLATING OPTIONS:**

- 1 - 0.05-0.13µm/2-5µin GOLD IN CONTACT AREA AND 1.88µm/75µin MIN. MATTE TIN IN SOLDER TAIL AREA OVER 1.27µm/50µin MIN. NICKEL OVERALL.
- 2 - 0.38µm/15µin MIN. GOLD IN CONTACT AREA AND 1.88µm/75µin MIN. MATTE TIN IN SOLDER TAIL AREA OVER 1.27µm/50µin MIN. NICKEL OVERALL.
- 3 - 0.76µm/30µin MIN. GOLD IN CONTACT AREA AND 1.88µm/75µin MIN. MATTE TIN IN SOLDER TAIL AREA OVER 1.27µm/50µin MIN. NICKEL OVERALL.
- 4 - 2.50µm/100µin MIN. MATTE TIN OVER 1.25µm/50µin MIN. NICKEL OVERALL.

THIS DRAWING CONTAINS INFORMATION THAT IS PROPRIETARY TO MOLEX ELECTRONIC TECHNOLOGIES, LLC AND SHOULD NOT BE USED WITHOUT WRITTEN PERMISSION

EC NO: 648718 DRWN: ABABUPS CHKD: MRAMAKRISHNA REV APPR: MRAMAKRISHNA	2020/09/29	GENERAL TOLERANCES (UNLESS SPECIFIED)		DIMENSION UNITS	SCALE				
	2020/11/09	MM	INCH	MM	NTS				
	2020/11/09	4 PLACES ±	±	DRWN BY	DATE	MILLIGRID 2MM PITCH, SMT VERTICAL SHROUDED HEADER			
	A15	3 PLACES ±	±	GMENARLY	2015/05/22				
	REV	2 PLACES ± 0.2	±	CHK'D BY	DATE	PRODUCT CUSTOMER DRAWING			
	A15	1 PLACES ±	±	CGOH	2015/09/21				
A15	0 PLACES ±	±	APPR BY	DATE	SERIES	MATERIAL NUMBER	CUSTOMER		
A15	ANGULAR TOL = 3.0		KHLIM	2015/09/22	87832	SEE TABLE	GENERAL MARKET		
DRAFT WHERE APPLICABLE MUST REMAIN WITHIN DIMENSIONS		DRAWING SIZE	THIRD ANGLE PROJECTION		DOCUMENT NUMBER		DOC TYPE	DOC PART	SHEET NUMBER
A3		A3			SD-87832-0001		PSD	001	5 OF 13

RELEASE STATUS	P1	RELEASE DATE	2020/11/09	04:05:48
----------------	----	--------------	------------	----------

# 8 TO 12 CIRCUITS

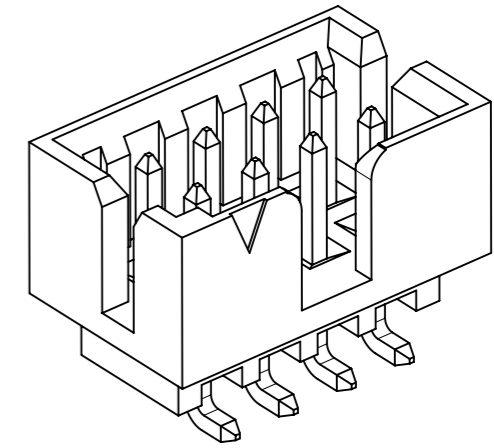
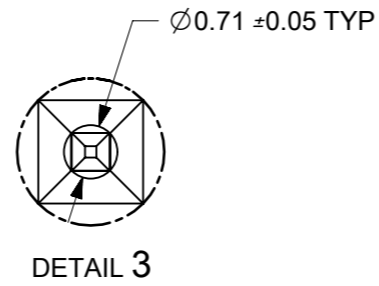
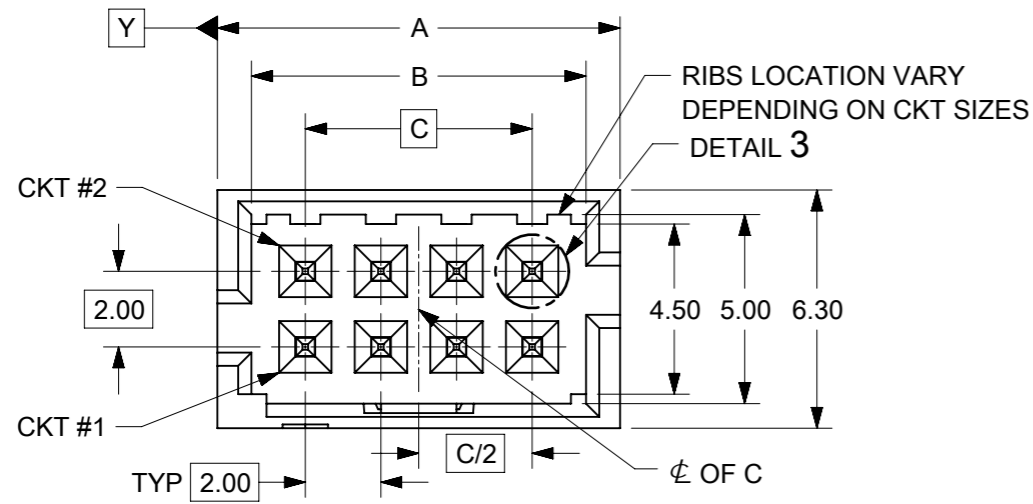

ISO VIEW OF HEADER WITH CENTER POLARIZATION AND DUAL SIDE SLOTS

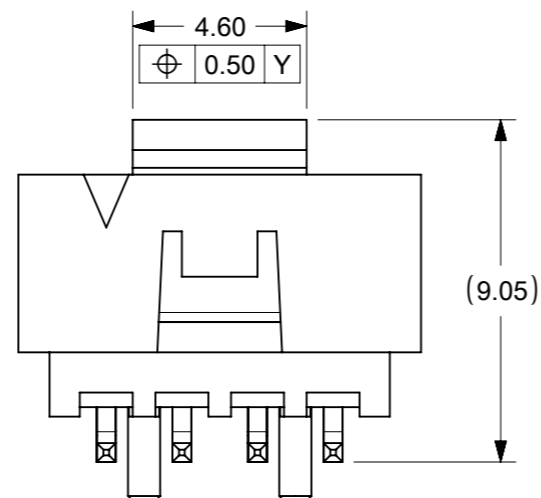
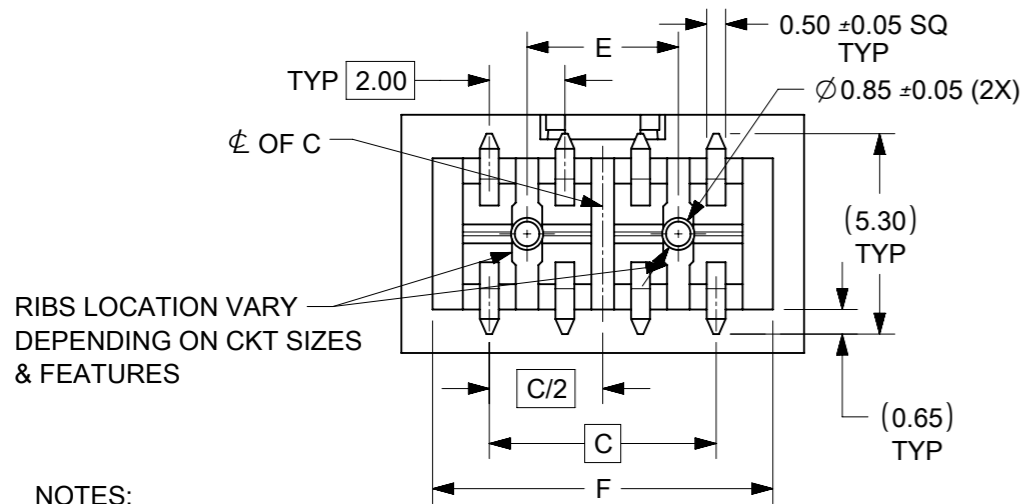
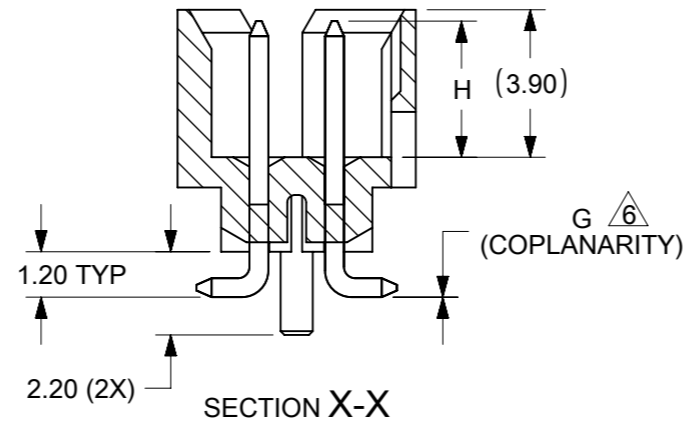
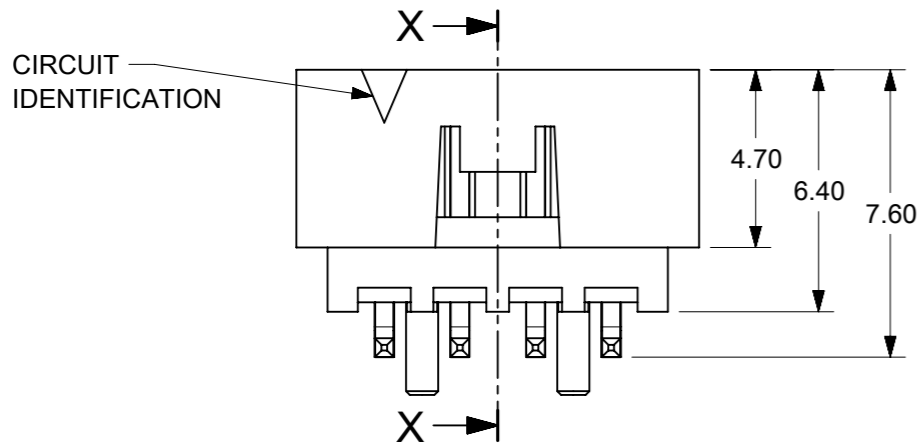

VIEW FOR HEADER WITH CAP

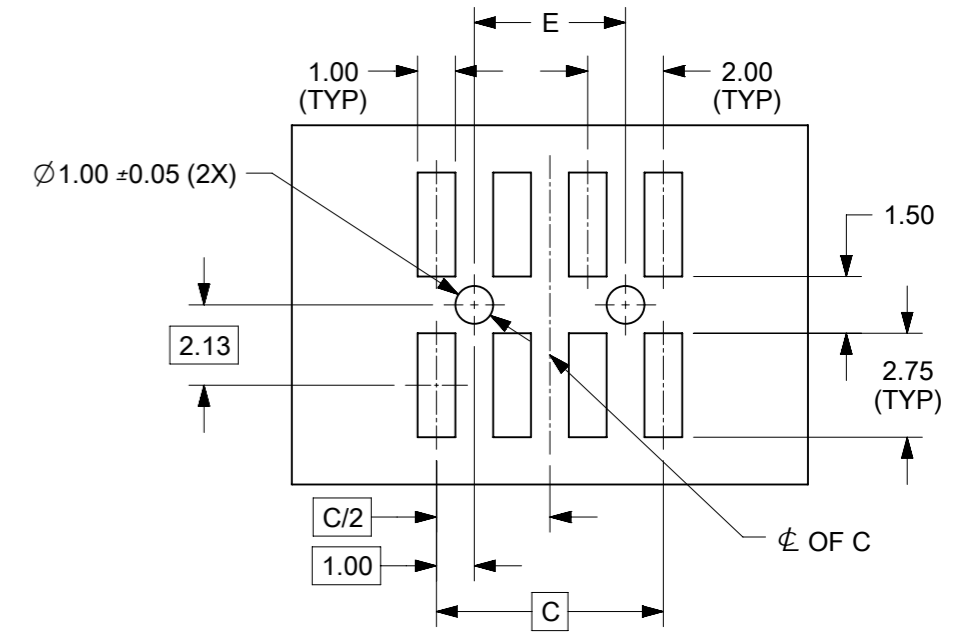
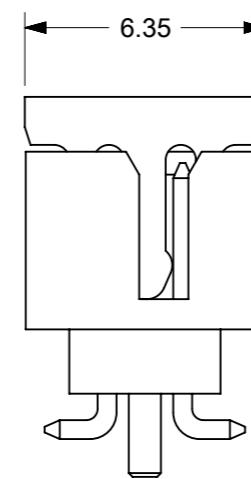

RECOMMENDED PCB LAYOUT

**NOTES:**

- MATERIALS:**  
HOUSING & CAP: 30% GF, NYLON, UL94V-0, COLOR: BLACK  
PIN: 0.50mm SQ. PHOSPHOR BRONZE
- FINISHES:** REFER TO PLATING OPTIONS
- PRODUCT SPECIFICATION:** PS-87831-027
- PACKAGING SPECIFICATION:** SEE PACKAGING SPECS TABLE ON SHEET 12
- MATES WITH:** A. MOLEX CRIMP RECEPTACLE HOUSING: 51110 SERIES AND CRIMP TERMINAL: 50394 SERIES  
B. MOLEX 2mm MILLIGRID DUAL ROW IDT: 87568 SERIES  
C. MOLEX 2mm MILLIGRID DUAL ROW RECEPTACLE: 79107 (GOLD PLATED), 78787 (TIN PLATED)
- COPLANARITY** IS TO BE MEASURED BY RESTING THE SOLDER TAIL ON A GAUGE SURFACE
- BEND DEPRESSION ON SMT TAIL IS ACCEPTABLE SO LONG AS IT DOES NOT AFFECT THE OVERALL COPLANARITY
- TOP SURFACE OF CAP TO BE FLAT FOR THE PURPOSE OF PICK & PLACE BY VACUUM SUCTION NOZZLE

THIS DRAWING CONTAINS INFORMATION THAT IS PROPRIETARY TO MOLEX ELECTRONIC TECHNOLOGIES, LLC AND SHOULD NOT BE USED WITHOUT WRITTEN PERMISSION

EC NO: 648718 DRWN: ABABUPS CHKD: MIRAMAKRISHNA REV APPR: MIRAMAKRISHNA	2020/09/29	2020/11/09	2020/11/09	GENERAL TOLERANCES (UNLESS SPECIFIED)		DIMENSION UNITS		SCALE			
				MM	INCH	MM	NTS				
	4 PLACES	±	±	DRWN BY	DATE						
	3 PLACES	±	±	CHK'D BY	DATE						
	2 PLACES	±	0.2	CGOH	2015/09/21						
1 PLACES	±	±	APPR BY	DATE							
0 PLACES	±	±	KHLIM	2015/09/22							
ANGULAR TOL = 3.0			DRAWING SIZE	THIRD ANGLE PROJECTION							
DRAFT WHERE APPLICABLE MUST REMAIN WITHIN DIMENSIONS			A3								
SERIES		MATERIAL NUMBER		CUSTOMER							
87832		SEE TABLE		GENERAL MARKET							
DOCUMENT NUMBER				DOC TYPE		DOC PART		SHEET NUMBER			
SD-87832-0001				PSD		001		6 OF 13			

8 TO 12 CIRCUITS

CKT SIZE	ASSY P/N WITHOUT CAP IN TUBE	ASSY P/N WITH CAP IN TUBE	ASSY P/N WITH CAP IN T&R	ASSY P/N WITHOUT CAP IN T&R	T&R OPTIONS (SEE SHEET 12)	PLATING OPTIONS	FRICTION LOCKS		DUAL SIDE SLOTS	CENTER POLARIZATION	PEGS	DIMENSION							
							DUAL	CENTER				A	B	C	D	E	F	G (COPLAN)	H
8	87832-0860	87832-0862	87832-5362		1	1	N.A	N.A	YES	YES	YES	10.65	8.85	6.00	N.A	4.00	9.00	0.10	3.60±0.20
	87832-0820	87832-0822	87832-5322		1	2												0.10	3.60±0.20
	87832-0821	87832-0823	87832-5323		1	3												0.10	3.60±0.15
	87832-0870	87832-0872	87832-5372		1	4	N.A	N.A	YES	YES	N.A							0.10	3.60±0.20
	87832-0812	87832-0816	87832-0814		1	2	N.A	YES	YES	N.A	N.A							0.10	3.60±0.20
	87832-0824	87832-0826	87832-0828		1	2	N.A	YES	YES	N.A	N.A							0.10	3.60±0.15
	87832-0825	87832-0827	87832-0829		1	3	N.A	YES	YES	N.A	YES							0.10	3.60±0.20
	87832-0810	87832-0808	87832-0806		1	2	N.A	YES	YES	N.A	YES							0.10	3.60±0.20
	87832-0811	87832-0809	87832-0807		1	3	N.A	YES	YES	N.A	YES							0.10	3.60±0.20
87832-0804	N.A	N.A		N.A	2	N.A	YES	YES	N.A	YES	0.10	3.60±0.20							
10	87832-1060	87832-1062	87832-5462		1	1	N.A	N.A	YES	YES	YES	12.65	10.85	8.00	N.A	6.00	11.00	0.10	3.60±0.20
	87832-1020	87832-1022	87832-5422	87832-5430(A14)	1	2												0.10	3.60±0.20
	87832-1021	87832-1023	87832-5423		1	3												0.10	3.60±0.20
			87832-9423		2		0.10	3.60±0.15											
	87832-1070	87832-1072	87832-5472		1	4	N.A	N.A	YES	YES	N.A							0.10	3.60±0.20
	87832-1012	87832-1016	87832-1014		1	2	N.A	YES	YES	N.A	N.A							0.10	3.60±0.15
	87832-1019	87832-1045	87832-1035		1	1	N.A	YES	YES	N.A	YES							0.10	3.60±0.20
	87832-1024	87832-1026	87832-1028		1	2	N.A	YES	YES	N.A	N.A							0.10	3.60±0.20
	N.A	N.A	87832-1055		1	1	N.A	YES	YES	N.A	YES							0.10	3.60±0.20
	87832-1025	87832-1027	87832-1029		1	3	N.A	YES	YES	N.A	YES							0.10	3.60±0.20
87832-1010	87832-1008	87832-1006		1	2	N.A	YES	YES	N.A	YES	0.10	3.60±0.20							
87832-1011	87832-1009	87832-1007		1	3	N.A	YES	YES	N.A	YES	0.10	3.60±0.20							
87832-1004	N.A	N.A		N.A	2	N.A	YES	YES	N.A	YES	0.10	3.60±0.20							
12	87832-1260	87832-1262	87832-5562		1	1	N.A	N.A	YES	YES	YES	14.65	12.85	10.00	N.A	8.00	13.00	0.10	3.60±0.20
	87832-1220	87832-1222	87832-5522		1	2												0.10	3.60±0.15
	87832-1221	87832-1223	87832-5523		1	3												0.10	3.60±0.20
			87832-9623		2		0.10	3.60±0.20											
	87832-1270	87832-1272	87832-5572		1	4	N.A	YES	YES	N.A	N.A							0.10	3.60±0.15
	87832-1224	87832-1226	87832-1228		1	2	N.A	YES	YES	N.A	YES							0.10	3.60±0.20
	87832-1225	87832-1227	87832-1229		1	3	N.A	YES	YES	N.A	YES							0.10	3.60±0.20
	87832-1210	87832-1208	87832-1206		1	2	N.A	YES	YES	N.A	YES							0.10	3.60±0.20
	87832-1211	87832-1209	87832-1207		1	3	N.A	YES	YES	N.A	YES							0.10	3.60±0.20
	87832-1204	N.A	N.A		N.A	2	N.A	YES	YES	N.A	YES							0.10	3.60±0.20
87832-1212	N.A	N.A		N.A	2	N.A	N.A	YES	YES	N.A	0.10	3.60±0.20							

**PLATING OPTIONS:**

- 1 - 0.05-0.13µm/2-5µin GOLD IN CONTACT AREA AND 1.88µm/75µin MIN. MATTE TIN IN SOLDER TAIL AREA OVER 1.27µm/50µin MIN. NICKEL OVERALL.
- 2 - 0.38µm/15µin MIN. GOLD IN CONTACT AREA AND 1.88µm/75µin MIN. MATTE TIN IN SOLDER TAIL AREA OVER 1.27µm/50µin MIN. NICKEL OVERALL.
- 3 - 0.76µm/30µin MIN. GOLD IN CONTACT AREA AND 1.88µm/75µin MIN. MATTE TIN IN SOLDER TAIL AREA OVER 1.27µm/50µin MIN. NICKEL OVERALL.
- 4 - 2.50µm/100µin MIN. MATTE TIN OVER 1.25µm/50µin MIN. NICKEL OVERALL.

THIS DRAWING CONTAINS INFORMATION THAT IS PROPRIETARY TO MOLEX ELECTRONIC TECHNOLOGIES, LLC AND SHOULD NOT BE USED WITHOUT WRITTEN PERMISSION

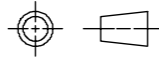
EC NO: 648718 DRWN: ABABUPS CHKD: MRAMAKRISHNA REV APPR: MRAMAKRISHNA	2020/09/29	2020/11/09	2020/11/09	GENERAL TOLERANCES (UNLESS SPECIFIED)		DIMENSION UNITS		SCALE		 MILLIGRID 2MM PITCH, SMT VERTICAL SHROUDED HEADER					
	4 PLACES ±		±	MM	INCH	MM	NTS	DRWN BY	DATE						
	3 PLACES ±		±	GMENARLY		2015/05/22		CHK'D BY	DATE	PRODUCT CUSTOMER DRAWING SERIES: 87832 MATERIAL NUMBER: SEE TABLE CUSTOMER: GENERAL MARKET					
	2 PLACES ± 0.2		±	CGOH		2015/09/21		APPR BY	DATE						
1 PLACES ±		±	KHLIM		2015/09/22		DRAWING SIZE		THIRD ANGLE PROJECTION		DOCUMENT NUMBER		DOC TYPE	DOC PART	SHEET NUMBER
0 PLACES ±		±	ANGULAR TOL = 3.0		A3				SD-87832-0001		PSD	001	7 OF 13		
DRAFT WHERE APPLICABLE MUST REMAIN WITHIN DIMENSIONS															

RELEASE STATUS	P1	RELEASE DATE	2020/11/09	04:05:48
----------------	----	--------------	------------	----------

# 14 TO 50 CIRCUITS

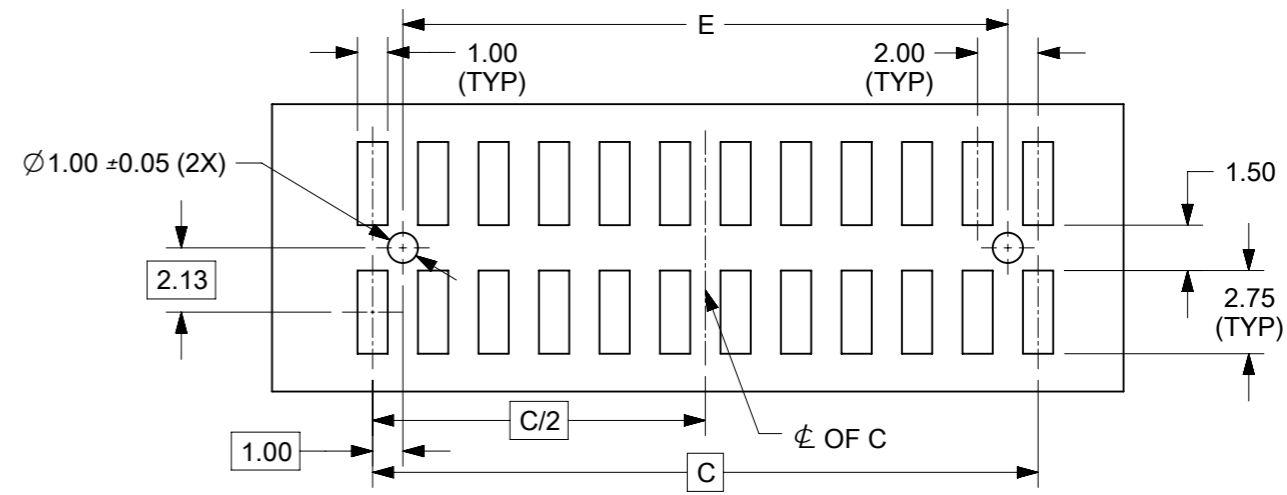
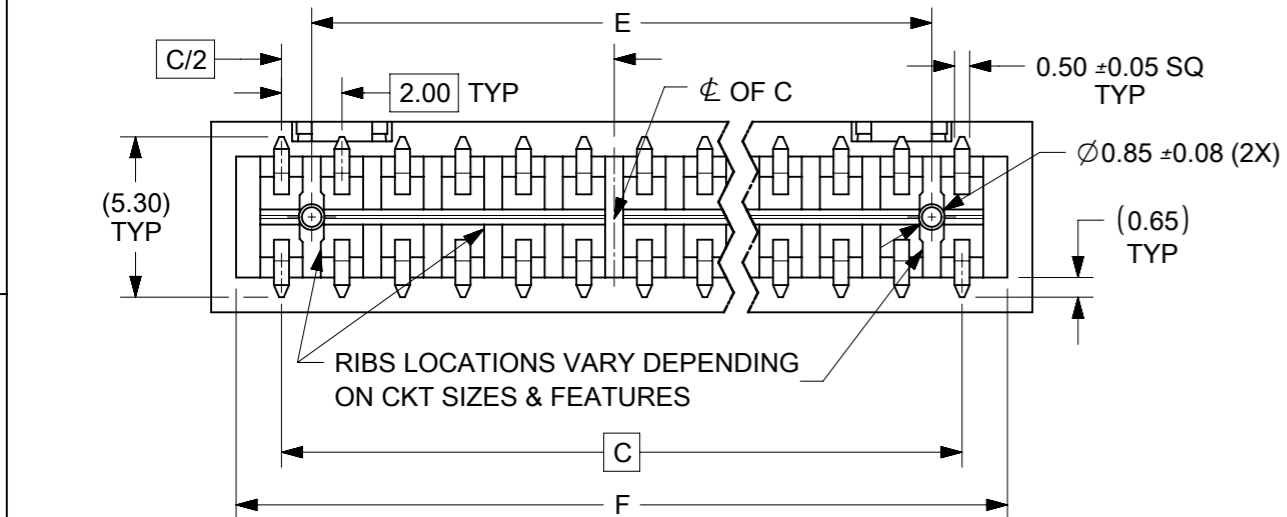
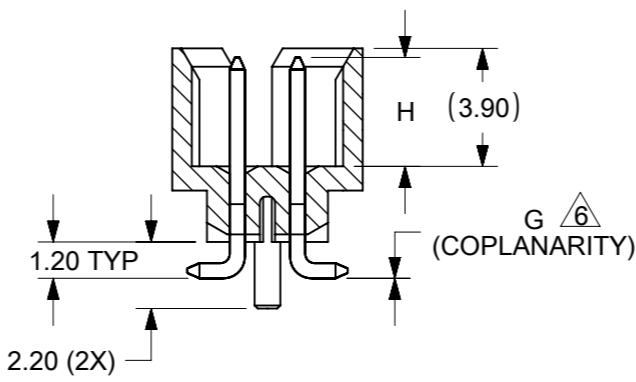
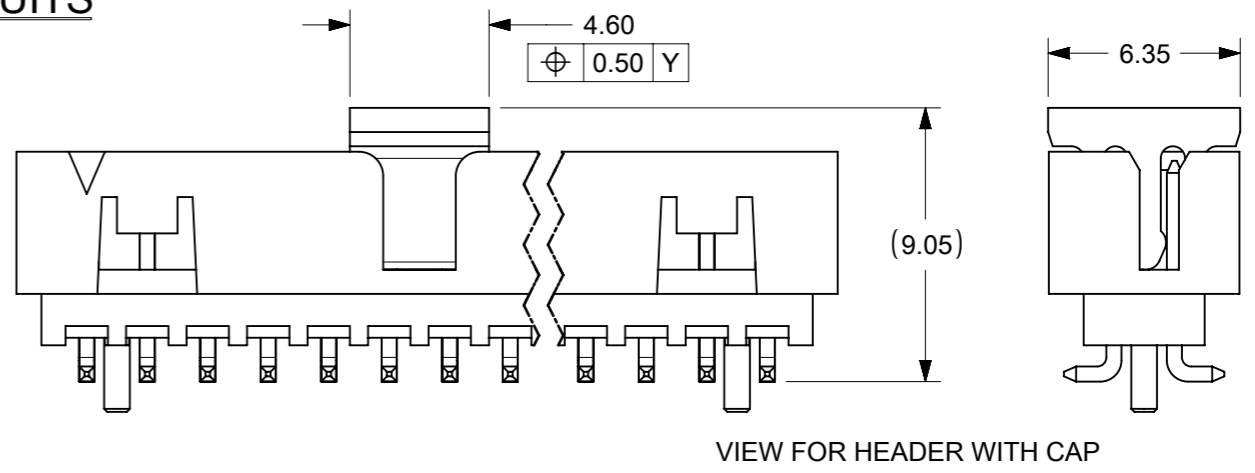
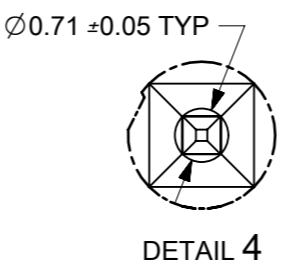
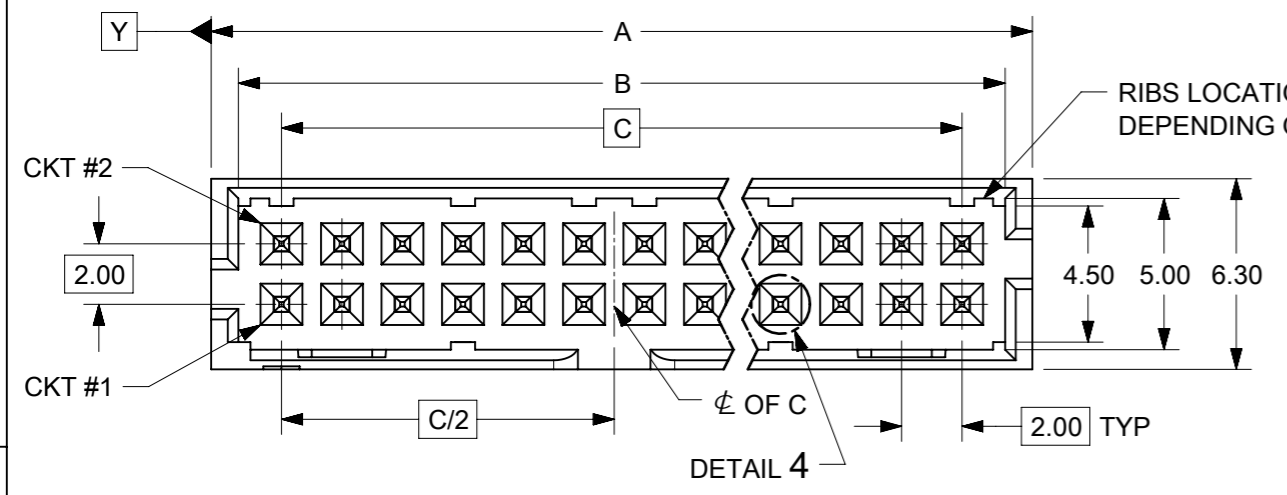

- NOTES:**
- 1. MATERIALS:**  
HOUSING & CAP: 30% GF, NYLON, UL94V-0, COLOR: BLACK  
PIN: 0.50mm SQ. PHOSPHOR BRONZE
  - 2. FINISHES:** REFER TO PLATING OPTIONS
  - 3. PRODUCT SPECIFICATION:** PS-87831-027
  - 4. PACKAGING SPECIFICATION:** SEE PACKAGING SPECS TABLE ON SHEET 12
  - 5. MATES WITH:** A. MOLEX CRIMP RECEPTACLE HOUSING: 51110 SERIES AND CRIMP TERMINAL: 50394 SERIES  
B. MOLEX 2mm MILLIGRID DUAL ROW IDT: 87568 SERIES  
C. MOLEX 2mm MILLIGRID DUAL ROW RECEPTACLE: 79107 (GOLD PLATED), 78787 (TIN PLATED)
  - 6. COPLANARITY IS TO BE MEASURED BY RESTING THE SOLDER TAIL ON A GAUGE SURFACE**
  - 7. BEND DEPRESSION ON SMT TAIL IS ACCEPTABLE SO LONG AS IT DOES NOT AFFECT THE OVERALL COPLANARITY**
  - 8. TOP SURFACE OF CAP TO BE FLAT FOR THE PURPOSE OF PICK & PLACE BY VACUUM SUCTION NOZZLE**

THIS DRAWING CONTAINS INFORMATION THAT IS PROPRIETARY TO MOLEX ELECTRONIC TECHNOLOGIES, LLC AND SHOULD NOT BE USED WITHOUT WRITTEN PERMISSION

EC NO: 648718 DRWN: ABABUPS CHKD: MRAMAKRISHNA APPR: MRAMAKRISHNA	2020/09/29	GENERAL TOLERANCES (UNLESS SPECIFIED)		DIMENSION UNITS		SCALE						
	2020/11/09	MM	INCH	MM	NTS	DRWN BY						DATE
	2020/11/09	4 PLACES	±	±	GMENARLY		2015/05/22		MILLIGRID 2MM PITCH, SMT VERTICAL SHROUDED HEADER			
		3 PLACES	±	±	CHK'D BY		DATE					
	2 PLACES	±	0.2	±	CGOH		2015/09/21		PRODUCT CUSTOMER DRAWING			
	1 PLACES	±	±	APPR BY		DATE						
	0 PLACES	±	±	KHLIM		2015/09/22		SERIES: 87832 MATERIAL NUMBER: SEE TABLE CUSTOMER: GENERAL MARKET				
	ANGULAR TOL = 3.0		DRAWING SIZE		THIRD ANGLE PROJECTION		DOCUMENT NUMBER: SD-87832-0001 DOC TYPE: PSD DOC PART: 001 SHEET NUMBER: 8 OF 13					
	DRAFT WHERE APPLICABLE MUST REMAIN WITHIN DIMENSIONS		A3									



14 TO 24 CIRCUITS

CKT SIZE	ASSY P/N WITHOUT CAP IN TUBE	ASSY P/N WITH CAP IN TUBE	ASSY P/N WITH CAP IN T&R	ASSY P/N WITHOUT CAP IN T&R	T&R OPTIONS (SEE SHEET 12)	PLATING OPTIONS	FRICTION LOCKS		DUAL SIDE SLOTS	CENTER POLARIZATION	PEGS	DIMENSION							So (T&R)		
							DUAL	CENTER				A	B	C	D	E	F	#####		H	
14	87832-1460	87832-1462	87832-5662		1	1															
	87832-1420	87832-1422	87832-5622	87832-5630 (A14)	1	2															
	87832-1421	87832-1423	87832-5623		1	3	YES	N.A	YES	YES	YES	16.65	14.85	12.00	8.00	10.00	15.00	0.15	3.60±0.20		
			87832-9523		2																
	87832-1470	87832-1472	87832-5672		1	4															
87832-1412	87832-1416	87832-1414		1	2	YES	N.A	YES	YES	N.A							0.15	3.60±0.20			
16	87832-1660	87832-1662	87832-5762		1	1															
	87832-1620	87832-1622	87832-5722		1	2	YES	N.A	YES	YES	18.65	16.85	14.00	10.00	12.00	17.00	0.15	3.60±0.20			
	87832-1621	87832-1623	87832-5723		1	3															
	87832-1670	87832-1672	87832-5772		1	4															
	87832-1612	87832-1616	87832-1614		1	2	YES	N.A	YES	YES	N.A							0.15	3.60±0.20		
	87832-1619	87832-1645	87832-1635		1	1															
18	87832-1860	87832-1862	87832-5862		1	1	YES	N.A	YES	YES	20.65	18.85	16.00	12.00	14.00	19.00	0.15	3.60±0.20			
	87832-1820	87832-1822	87832-5822	87832-5830 (A14)	1	2															
	87832-1821	87832-1823	87832-5823		1	3															
	87832-1870	87832-1872	87832-5872		1	4															
	87832-1812	87832-1816	87832-1814		3	2	YES	N.A	YES	YES	N.A							0.15	3.60±0.20		
	87832-1813	87832-1817	87832-1815		3	3	YES	N.A	YES	YES	N.A							0.15	3.60±0.20		
20	87832-2060	87832-2062	87832-5962		1	1	YES	N.A	YES	YES	22.65	20.85	18.00	14.00	16.00	21.00	0.15	3.60±0.20			
	87832-2020	87832-2022	87832-5922	87832-5930 (A14)	1	2															
	87832-2021	87832-2023	87832-5923		1	3															
			87832-5972		1	4															
	87832-2070	87832-2072	87832-9672		2																
87832-2012	87832-2016	87832-2014		1	2	YES	N.A	YES	YES	N.A							0.15	3.60±0.20	40.40		
22	87832-2260	87832-2262	87832-6062		1	1	YES	N.A	YES	YES	24.65	22.85	20.00	16.00	18.00	23.00	0.15	3.60±0.20			
	87832-2220	87832-2222	87832-6022	87832-6030 (A14)	1	2															
	87832-2221	87832-2223	87832-6023		1	3															
	87832-2270	87832-2272	87832-6072		1	4															
24	87832-2460	87832-2462	87832-6162		1	1	YES	N.A	YES	YES	26.65	24.85	22.00	18.00	20.00	25.00	0.15	3.60±0.20			
	87832-2420	87832-2422	87832-6122	87832-6130 (A14)	1	2															
	87832-2421	87832-2423	87832-6123		1	3															
	87832-2470	87832-2472	87832-6172		1	4															
	87832-2412	87832-2416	87832-2414		1	2	YES	N.A	YES	YES	N.A							0.15	3.60±0.20		

PLATING OPTIONS:

- 1 - 0.05-0.13µm/2-5µin GOLD IN CONTACT AREA AND 1.88µm/75µin MIN. MATTE TIN IN SOLDER TAIL AREA OVER 1.27µm/50µin MIN. NICKEL OVERALL.
- 2 - 0.38µm/15µin MIN. GOLD IN CONTACT AREA AND 1.88µm/75µin MIN. MATTE TIN IN SOLDER TAIL AREA OVER 1.27µm/50µin MIN. NICKEL OVERALL.
- 3 - 0.76µm/30µin MIN. GOLD IN CONTACT AREA AND 1.88µm/75µin MIN. MATTE TIN IN SOLDER TAIL AREA OVER 1.27µm/50µin MIN. NICKEL OVERALL.
- 4 - 2.50µm/100µin MIN. MATTE TIN OVER 1.25µm/50µin MIN. NICKEL OVERALL.

THIS DRAWING CONTAINS INFORMATION THAT IS PROPRIETARY TO MOLEX ELECTRONIC TECHNOLOGIES, LLC AND SHOULD NOT BE USED WITHOUT WRITTEN PERMISSION

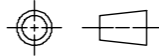
EC NO: 648718 DRWN: ABABUPS CHKD: MRAMAKRISHNA REV APPR: MRAMAKRISHNA	2020/09/29	2020/11/09	2020/11/09	GENERAL TOLERANCES (UNLESS SPECIFIED)		DIMENSION UNITS		SCALE							
				MM	INCH	MM	NTS	DRWN BY						DATE	
	4 PLACES	±	±	GMENARLY		2015/05/22		CHK'D BY		DATE					
	3 PLACES	±	±	CGOH		2015/09/21		APPR BY		DATE					
2 PLACES	±	0.2	KHLIM		2015/09/22		DRAWING SIZE		THIRD ANGLE PROJECTION		SERIES	MATERIAL NUMBER	CUSTOMER		
1 PLACES	±	±	ANGULAR TOL = 3.0		A3		7.62				87832	SEE TABLE	GENERAL MARKET		
0 PLACES	±	±	DRAFT WHERE APPLICABLE MUST REMAIN WITHIN DIMENSIONS								DOCUMENT NUMBER		DOC TYPE	DOC PART	SHEET NUMBER
											SD-87832-0001		PSD	001	9 OF 13

26 TO 38 CIRCUITS

CKT SIZE	ASSY P/N WITHOUT CAP IN TUBE	ASSY P/N WITH CAP IN TUBE	ASSY P/N WITH CAP IN T&R	ASSY P/N WITHOUT CAP IN T&R	T&R OPTIONS (SEE SHEET 12)	PLATING OPTIONS	FRICTION LOCKS		DUAL SIDE SLOTS	CENTER POLARIZATION	PEGS	DIMENSION																		
							DUAL	CENTER				A	B	C	D	E	F	G (COPLAN)	H											
E 26	87832-2660	87832-2662	87832-6262		1	1	YES	N.A	YES	YES	YES	28.65	26.85	24.00	20.00	22.00	27.00	0.15	3.60±0.20											
	87832-2620	87832-2622	87832-6222		1	2																								
	87832-2621	87832-2623	87832-6223		1	3																								
	87832-2670	87832-2672	87832-6272		1	4												YES	N.A	YES	YES	N.A							0.15	3.60±0.20
	87832-2612	87832-2616	N.A		N.A	2																								
	87832-2619	87832-2645	87832-2635		1	1																								
D 28	87832-2860	87832-2862	87832-6362		1	1	YES	N.A	YES	YES	YES	30.65	28.85	26.00	22.00	24.00	29.00	0.15	3.60±0.20											
	87832-2820	87832-2822	87832-6322		1	2																								
	87832-2821	87832-2823	87832-6323		1	3																								
	87832-2870	87832-2872	87832-6372		1	4												YES	N.A	YES	YES	N.A							0.15	3.60±0.20
	N.A	87832-2816	N.A		1	2																								
	N.A	87832-2819	N.A		1	1																								
D 30	87832-3060	87832-3062	87832-6462		1	1	YES	N.A	YES	YES	YES	32.65	30.85	28.00	24.00	26.00	31.00	0.15	3.60±0.20											
	87832-3020	87832-3022	87832-6422		1	2																								
	87832-3021	87832-3023	87832-6423		1	3																								
	87832-3070	87832-3072	87832-6472		1	4												YES	N.A	YES	YES	N.A							0.15	3.60±0.20
	87832-3012	87832-3016	87832-3014		3	2																								
C 32	87832-3260	87832-3262	87832-6562		1	1	YES	N.A	YES	YES	YES	34.65	32.85	30.00	26.00	28.00	33.00	0.15	3.60±0.20											
	87832-3220	87832-3222	87832-6522		1	2																								
	87832-3221	87832-3223	87832-6523		1	3																								
	87832-3270	87832-3272	87832-6572		1	4																								
C 34	87832-3460	87832-3462	87832-6662	87832-6630	1	1	YES	N.A	YES	YES	YES	36.65	34.85	32.00	28.00	30.00	35.00	0.15	3.60±0.20											
	87832-3420	87832-3422	87832-6622		1	2																								
	87832-3421	87832-3423	87832-6623		1	3																								
	87832-3470	87832-3472	87832-6672		1	4												YES	N.A	YES	YES	N.A							0.15	3.60±0.20
	87832-3412	87832-3416	87832-3414		3	2																								
	87832-3419	87832-3445	87832-3435		3	1																								
B 36	87832-3660	87832-3662	N.A		N.A	1	YES	N.A	YES	YES	YES	38.65	36.85	34.00	30.00	32.00	37.00	0.15	3.60±0.20											
	87832-3620	87832-3622	N.A		N.A	2																								
	87832-3621	87832-3623	N.A		N.A	3																								
	87832-3670	87832-3672	N.A		N.A	4																								
B 38	87832-3860	87832-3862	N.A		N.A	1	YES	N.A	YES	YES	YES	40.65	38.85	36.00	32.00	34.00	39.00	0.15	3.60±0.20											
	87832-3820	87832-3822	87832-6822		N.A	2																								
	87832-3821	87832-3823	N.A		N.A	3																								
	87832-3870	87832-3872	N.A		N.A	4																								

PLATING OPTIONS:

- 0.05-0.13µm/2-5µm GOLD IN CONTACT AREA AND 1.88µm/75µm MIN. MATTE TIN IN SOLDER TAIL AREA OVER 1.27µm/50µm MIN. NICKEL OVERALL.
- 0.38µm/15µm MIN. GOLD IN CONTACT AREA AND 1.88µm/75µm MIN. MATTE TIN IN SOLDER TAIL AREA OVER 1.27µm/50µm MIN. NICKEL OVERALL.
- 0.76µm/30µm MIN. GOLD IN CONTACT AREA AND 1.88µm/75µm MIN. MATTE TIN IN SOLDER TAIL AREA OVER 1.27µm/50µm MIN. NICKEL OVERALL.
- 2.50µm/100µm MIN. MATTE TIN OVER 1.25µm/50µm MIN. NICKEL OVERALL.

THIS DRAWING CONTAINS INFORMATION THAT IS PROPRIETARY TO MOLEX ELECTRONIC TECHNOLOGIES, LLC AND SHOULD NOT BE USED WITHOUT WRITTEN PERMISSION

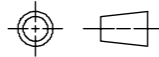
EC NO: 648718 DRWN: ABABUPS CHKD: MRAMAKRISHNA REV APPR: MRAMAKRISHNA	2020/09/29	2020/11/09	2020/11/09	GENERAL TOLERANCES (UNLESS SPECIFIED)		DIMENSION UNITS		SCALE							
				MM	INCH	MM	NTS								
				4 PLACES ±	±	DRWN BY	DATE	GMENARLY		2015/05/22	MILLIGRID 2MM PITCH, SMT VERTICAL SHROUDED HEADER				
				3 PLACES ±	±	CHK'D BY	DATE	CGOH		2015/09/21					
			2 PLACES ±	0.2	APPR BY	DATE	KHLIM		2015/09/22	PRODUCT CUSTOMER DRAWING					
			1 PLACES ±	±	DRAWING SIZE	THIRD ANGLE PROJECTION	A3								
			0 PLACES ±	±	ANGULAR TOL = 3.0						SERIES	MATERIAL NUMBER	CUSTOMER		
			DRAFT WHERE APPLICABLE MUST REMAIN WITHIN DIMENSIONS								87832	SEE TABLE	GENERAL MARKET		
											DOCUMENT NUMBER		DOC TYPE	DOC PART	SHEET NUMBER
											SD-87832-0001		PSD	001	10 OF 13

RELEASE STATUS	P1	RELEASE DATE	2020/11/09	04:05:48
----------------	----	--------------	------------	----------

### 40 TO 50 CIRCUITS

CKT SIZE	ASSY P/N WITHOUT CAP IN TUBE	ASSY P/N WITH CAP IN TUBE	ASSY P/N WITH CAP IN T&R	ASSY P/N WITHOUT CAP IN T&R	T&R OPTIONS (SEE SHEET 12)	PLATING OPTIONS	FRICTION LOCKS		DUAL SIDE SLOTS	CENTER POLARIZATION	PEGS	DIMENSION							
							DUAL	CENTER				A	B	C	D	E	F	G (COPLAN)	H
40	87832-4060	87832-4062	87832-6962		1	1						42.65	40.85	38.00	34.00	36.00	41.00	0.15	3.60±0.20
	87832-4020	87832-4022	87832-6922		1	2	YES	N.A	YES	YES	YES								
	87832-4021	87832-4023	87832-6923		1	3													
	87832-4070	87832-4072	87832-6972		1	4													
	87832-4012	87832-4016	N.A		N.A	2	YES	N.A	YES	YES	N.A							0.15	3.60±0.20
42	87832-4260	87832-4262	N.A		N.A	1	YES	N.A	YES	YES	YES	44.65	42.85	40.00	36.00	38.00	43.00	0.15	3.60±0.20
	87832-4220	87832-4222	N.A		N.A	2													
	87832-4221	87832-4223	N.A		N.A	3													
	87832-4270	87832-4272	N.A		N.A	4													
44	87832-4460	87832-4462	87832-7162		1	1	YES	N.A	YES	YES	YES	46.65	44.85	42.00	38.00	40.00	45.00	0.15	3.60±0.20
	87832-4420	87832-4422	87832-7122		1	2													
	87832-4421	87832-4423	87832-7123		1	3													
	87832-4470	87832-4472	87832-7172		1	4													
	87832-4413	87832-4417	87832-4415		3	3												YES	N.A
46	87832-4660	87832-4662	87832-7262		1	1	YES	N.A	YES	YES	YES	48.65	46.85	44.00	40.00	42.00	47.00	0.15	3.60±0.20
	87832-4620	87832-4622	87832-7222	87832-7230 (A14)	1	2													
	87832-4621	87832-4623	N.A		N.A	3													
	87832-4670	87832-4672	87832-7272		1	4													
48	87832-4860	87832-4862	N.A		N.A	1	YES	N.A	YES	YES	YES	50.65	48.85	46.00	42.00	44.00	49.00	0.15	3.60±0.20
	87832-4820	87832-4822	N.A		N.A	2													
	87832-4821	87832-4823	N.A		N.A	3													
	87832-4870	87832-4872	N.A		N.A	4													
50	87832-5060	87832-5062	87832-7462		1	1	YES	N.A	YES	YES	YES	52.65	50.85	48.00	44.00	46.00	51.00	0.15	3.60±0.20
	87832-5020	87832-5022	87832-7422		1	2													
	87832-5021	87832-5023	87832-7423		1	3													
	87832-5070	87832-5072	87832-7472		1	4													
	87832-5012	87832-5016	N.A		N.A	2												YES	N.A

**PLATING OPTIONS:**

- 1 - 0.05-0.13µm/2-5µin GOLD IN CONTACT AREA AND 1.88µm/75µin MIN. MATTE TIN IN SOLDER TAIL AREA OVER 1.27µm/50µin MIN. NICKEL OVERALL.
- 2 - 0.38µm/15µin MIN. GOLD IN CONTACT AREA AND 1.88µm/75µin MIN. MATTE TIN IN SOLDER TAIL AREA OVER 1.27µm/50µin MIN. NICKEL OVERALL.
- 3 - 0.76µm/30µin MIN. GOLD IN CONTACT AREA AND 1.88µm/75µin MIN. MATTE TIN IN SOLDER TAIL AREA OVER 1.27µm/50µin MIN. NICKEL OVERALL.
- 4 - 2.50µm/100µin MIN. MATTE TIN OVER 1.25µm/50µin MIN. NICKEL OVERALL.

THIS DRAWING CONTAINS INFORMATION THAT IS PROPRIETARY TO MOLEX ELECTRONIC TECHNOLOGIES, LLC AND SHOULD NOT BE USED WITHOUT WRITTEN PERMISSION

EC NO: 648718 DRWN: ABABUPS CHKD: MRAMAKRISHNA REV APPR: MRAMAKRISHNA	2020/09/29	2020/11/09	2020/11/09	GENERAL TOLERANCES (UNLESS SPECIFIED)		MM	NTS	<b>molex®</b>	
	4 PLACES ±		±		DRWN BY	DATE	MILLIGRID 2MM PITCH, SMT VERTICAL SHROUDED HEADER  PRODUCT CUSTOMER DRAWING		
	3 PLACES ±		±		GMENARLY	2015/05/22			
	2 PLACES ± 0.2		±		CHK'D BY	DATE			
	1 PLACES ±		±		CGOH	2015/09/21			
0 PLACES ±		±		APPR BY	DATE	SERIES: 87832    MATERIAL NUMBER: SEE TABLE    CUSTOMER: GENERAL MARKET			
ANGULAR TOL = 3.0				KHLIM	2015/09/22				
DRAFT WHERE APPLICABLE MUST REMAIN WITHIN DIMENSIONS				DRAWING SIZE	THIRD ANGLE PROJECTION	DOCUMENT NUMBER: SD-87832-0001    DOC TYPE: PSD    DOC PART: 001    SHEET NUMBER: 11 OF 13			
				A3					

# PACKAGING OPTIONS

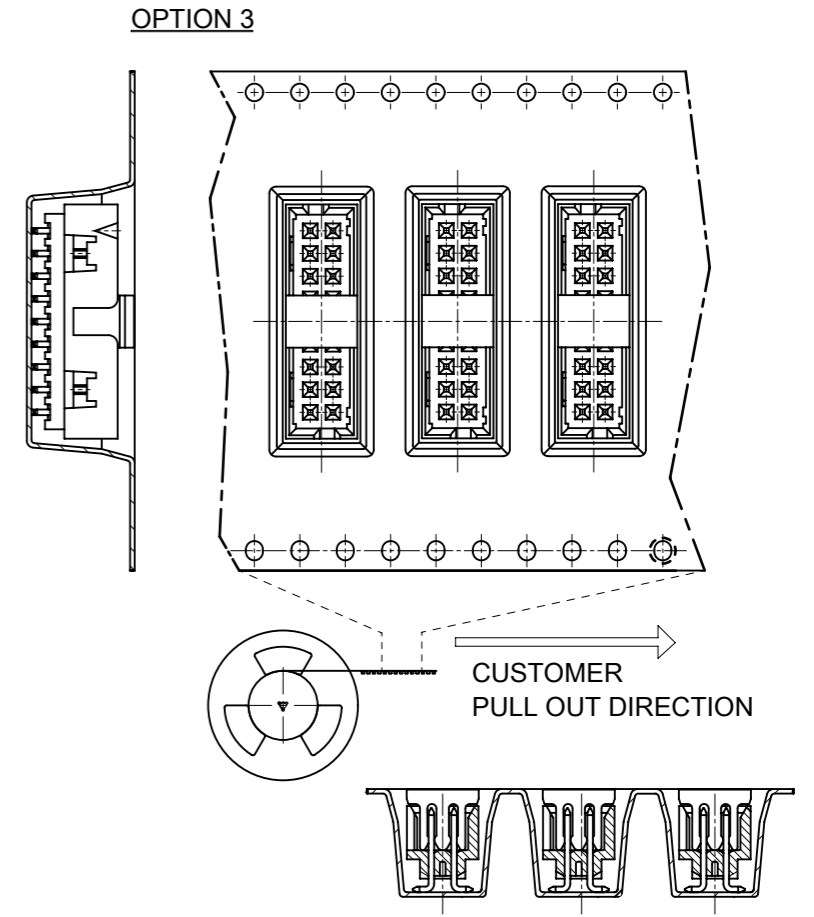
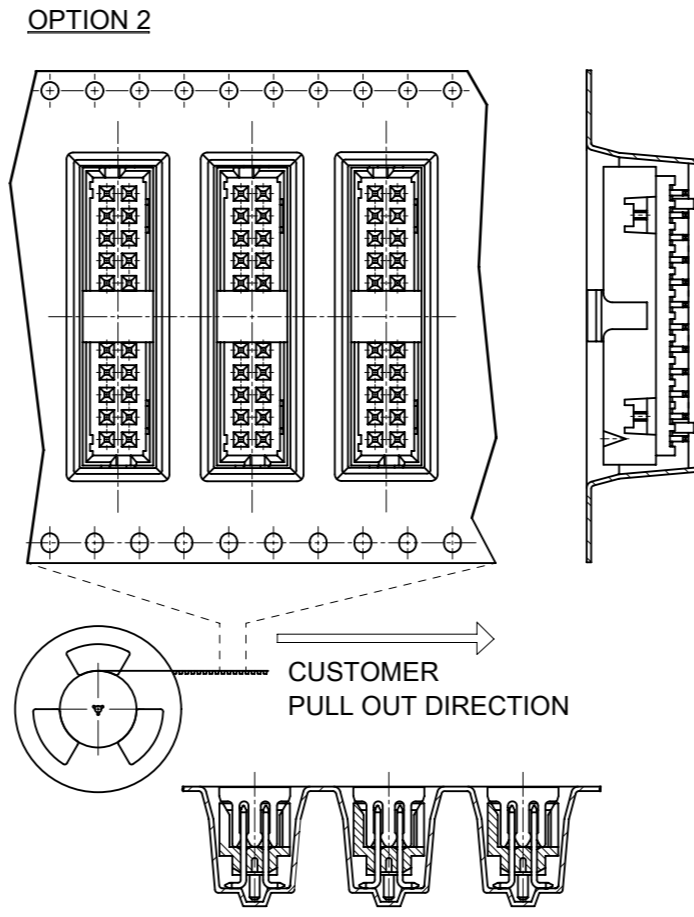
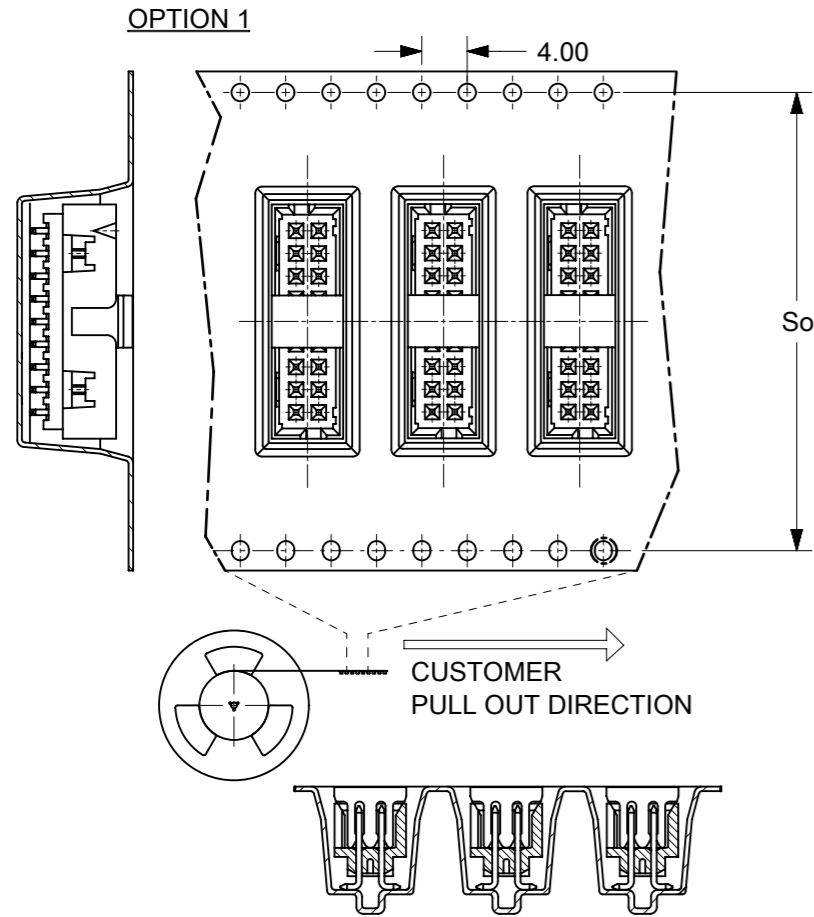

**VIEW FOR 1 SIDE PILOT HOLE**

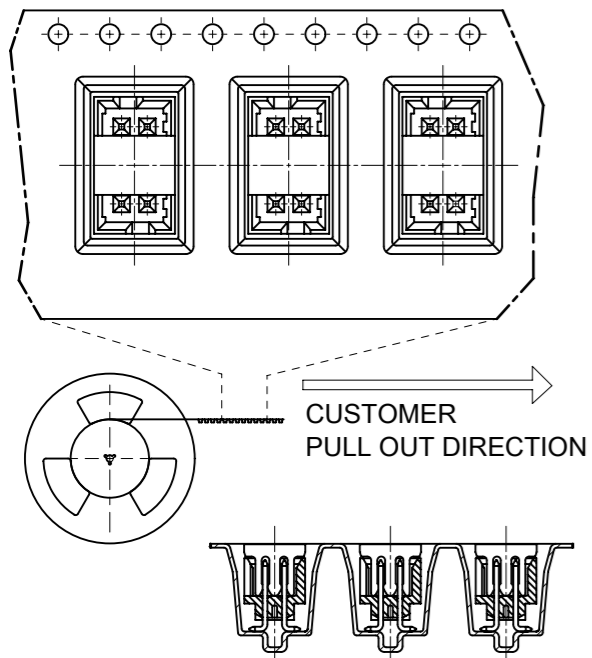

**PACKAGING SPECIFICATION TABLE**

TAPE AND REEL PACKAGING	PK-87832-300
TUBE STANDARD PACKAGING	PK-87831-001
TUBE NON-STANDARD PACKAGING FOR: 87832-0411 87832-0824 87832-1072 87832-1412	PK-87831-002

**EMBOSSED TAPE & REEL POCKET DESCRIPTIONS**

OPTIONS	CENTER POLARIZATION OPTIONS		PEG OPTIONS		PILOT HOLE OPTIONS	
	ON THE LEFT	ON THE RIGHT	WITH PEG	WITHOUT PEG	2 SIDES	1 SIDE
1	YES	N.A	YES	N.A	CKT 12-50	CKT 4-10
2	N.A	YES	YES	YES	CKT 12-50	CKT 4-10
3	YES	N.A	N.A	YES	CKT 12-50	CKT 4-10

THIS DRAWING CONTAINS INFORMATION THAT IS PROPRIETARY TO MOLEX ELECTRONIC TECHNOLOGIES, LLC AND SHOULD NOT BE USED WITHOUT WRITTEN PERMISSION

EC NO: 648718 DRWN: ABABUPS CHK'D: MRAMAKRISHNA REV APPR: MRAMAKRISHNA	2020/09/29	GENERAL TOLERANCES (UNLESS SPECIFIED)		DIMENSION UNITS	SCALE			
	2020/11/09	MM	INCH	MM	NTS			
	2020/11/09	4 PLACES ±	±	DRWN BY	DATE		MILLIGRID 2MM PITCH, SMT VERTICAL SHROUDED HEADER	
		3 PLACES ±	±	GMENARLY	2015/05/22			
	2 PLACES ± 0.2	±	CHK'D BY	DATE	PRODUCT CUSTOMER DRAWING			
	1 PLACES ±	±	CGOH	2015/09/21				
	0 PLACES ±	±	APPR BY	DATE	SERIES: 87832 MATERIAL NUMBER: SEE TABLE CUSTOMER: GENERAL MARKET			
	ANGULAR TOL = 3.0		KHLIM	2015/09/22				
	DRAFT WHERE APPLICABLE MUST REMAIN WITHIN DIMENSIONS		DRAWING SIZE	THIRD ANGLE PROJECTION	DOCUMENT NUMBER: SD-87832-0001	DOC TYPE: PSD	DOC PART: 001	SHEET NUMBER: 12 OF 13
A15			A3					

**BOARD TO BOARD (BTB) DISTANCE**

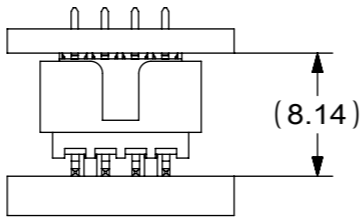
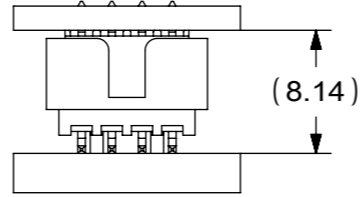
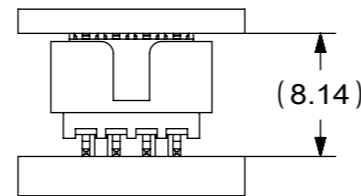
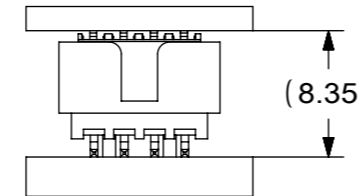
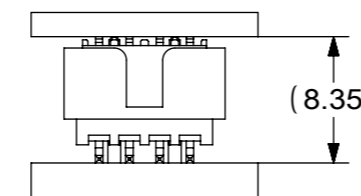
HEADER	MATES WITH (RECEPTACLE)	BTB DIST.	PICTORIAL VIEW
87832	79107	8.14	
	78787	8.14	
	79108	8.14	
	79109	8.35	
	78788	8.35	

THIS DRAWING CONTAINS INFORMATION THAT IS PROPRIETARY TO MOLEX ELECTRONIC TECHNOLOGIES, LLC AND SHOULD NOT BE USED WITHOUT WRITTEN PERMISSION											
DIMENSION UNITS		SCALE		CURRENT REV DESC:						<b>molex</b>	
mm		NTS									
GENERAL TOLERANCES (UNLESS SPECIFIED)				EC NO: 648718		DRWN: ABABUPS		2020/09/29		MILLIGRID	
				CHK'D: MRAMAKRISHNA		2020/11/09		2MM PITCH, SMT VERTICAL SHROUDED HEADER			
				APPR: MRAMAKRISHNA		2020/11/09		PRODUCT CUSTOMER DRAWING			
1 PLACE ±				INITIAL REVISION:		DRWN: DRWN BY		XXXX/XX/XX		DOCUMENT NUMBER	
0 PLACES ±				APPR: APPR BY		XXXX/XX/XX		SD-87832-0001		DOC TYPE	
ANGULAR TOL ± 3.0°				THIRD ANGLE PROJECTION		DRAWING		SERIES		DOC PART	
DRAFT WHERE APPLICABLE MUST REMAIN WITHIN DIMENSIONS				A3-SIZE		87832		MATERIAL NUMBER		REVISION	
				GENERAL MARKET		CUSTOMER		13 OF 13		SHEET NUMBER	