

13	12	11	10	9	8	7	6	5	4	3	2	1
ASSEMBLY NUMBER		FINISH										
73656-0000		SEE NOTE 2.										
73656-0001		SEE NOTE 3.										

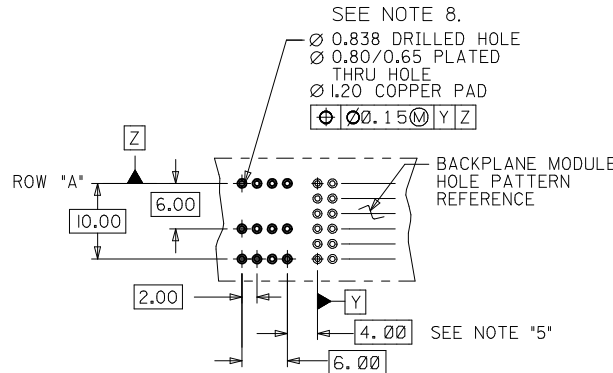
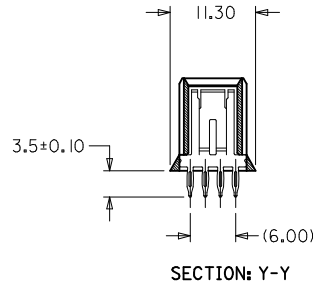
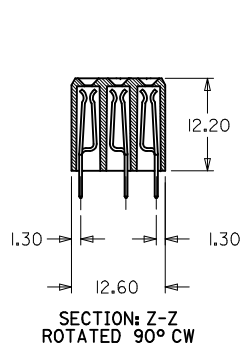
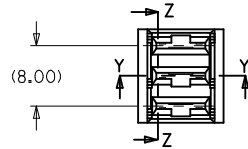
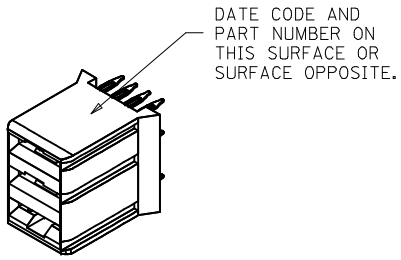

PCB LAYOUT: COMPONENT SIDE
RECOMMENDED PCB THICKNESS: 2.50 MIN

NOTES:

1. MATERIALS: HOUSING - LIQUID CRYSTAL POLYMER (LCP), GLASS-FILLED, UL94V-0, COLOR: BLACK
TERMINAL - COPPER ALLOY
2. FINISH: SELECTIVE GOLD (Au) IN CONTACT AREA, 0.76 micrometer MINIMUM THICKNESS: NICKEL (Ni) AND GOLD FLASH OVERALL
3. FINISH: SELECTIVE GOLD (Au) IN CONTACT AREA, 0.76 micrometer MINIMUM THICKNESS: MATTE TIN (Sn) OVER NICKEL (Ni) IN COMPLIANT AREA: NICKEL (Ni) OVERALL ON REMAINING WITH SELECTIVE GOLD (Au) FLASH.
4. THIS DIMENSION MUST BE A MULTIPLE OF 4.00 mm.
5. DIMENSIONS ARE IN MILLIMETERS.
6. THIS PART CONFORMS TO MOLEX PRODUCT SPECIFICATION PS-73670-9999.
7. PACKAGE ASSEMBLIES PER PK-70873-0819.
8. HOLE SIZE SPECIFICATION IS FOR TIN/LEAD PLATED HOLES ONLY. FOR OTHER PLATING TYPES SEE MOLEX APPLICATION AS-73670-9996.
9. THIS PART CONFORMS TO MOLEX COSMETIC SPECIFICATION PS-45499-002 CLASS B.

LEAD FREE CONVERSION EC NO: UCP2013-3253 DRAWN:WHIPPLE 2013/02/04 CHKD:WOLFE 2013/02/04 APPR:SMILLER 2013/08/05	DESCRIPTION	QUALITY SYMBOLS	GENERAL TOLERANCES (UNLESS SPECIFIED)	DIMENSION STYLE MM ONLY	SCALE 1:1	DESIGN UNITS METRIC	THIRD ANGLE PROJECTION
REV		▽=0	mm	DRAWN BY ELO	DATE 1998/05/21	SALES ASSY, HDM BACKPLANE POWER MODULE (PRESSFIT) molex DOCUMENT NO. SDA-73656-X00X SHEET NO. 1 OF 4	
		▽=0	INCH	CHECKED BY SMR	DATE 1998/05/21		
		▽=0	4 PLACES ±---	APPROVED BY CAB	DATE 1998/05/21		
			3 PLACES ±---	MATERIAL NO.			
			2 PLACES ±0.13	SIZE			
			1 PLACE ±0.25	SEE TABLE			
			0 PLACE ±---	DRAFT WHERE APPLICABLE MUST REMAIN WITHIN DIMENSIONS			

10 9 8 7 6 5 4 3 2 1

DATE CODE AND
PART NUMBER ON
THIS SURFACE OR
SURFACE OPPOSITE.

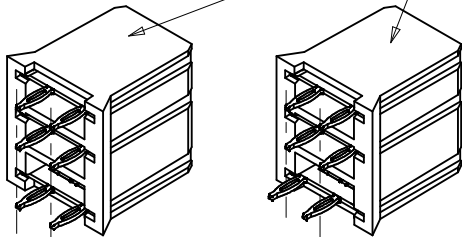

73656-100*

73656-200*

MIDPLANE OPTION

ASSEMBLY NUMBER	FINISH (SEE SHT 1)
73656-1000	SEE NOTE 2. (GOLD TAILS)
73656-2000	
73656-1001	SEE NOTE 3. *(MATTE TIN TAILS)
73656-2001	

* FORMERLY TIN/LEAD

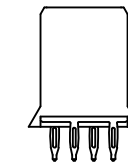
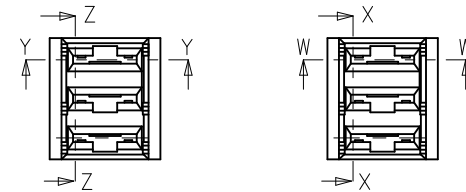

73656-200*

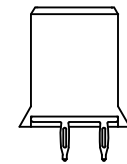

73656-100*

USE BACKPLANE MODULE
HOLE REFERENCE PATTERN
FROM SHEET 1

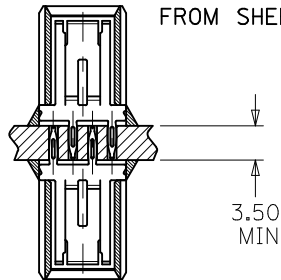

BACK-TO-BACK
MOUNTING APPLICATION

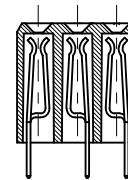

SECTION X-X
SECTION Z-Z
ROTATED 90° CW

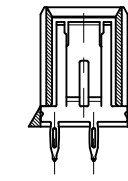

(4.00)
SECTION: Y-Y

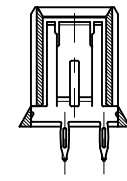

(4.00)
SECTION: W-W

SEE SHEET 1 EC NO: UCP2013-3253 DRAWN: RWHIPPLE 2013/02/04 CHKD: MWOLFE 2013/02/04 APPR: SMILLER 2013/08/05	QUALITY SYMBOLS	GENERAL TOLERANCES (UNLESS SPECIFIED)	DIMENSION STYLE	SCALE	DESIGN UNITS	THIRD ANGLE PROJECTION
	▽=0	mm INCH	MM ONLY	1:1	METRIC	⊙
	▽=0	4 PLACES ± --- ± ---	DRAWN BY DATE	SALES ASSY, HDM BACKPLANE POWER MODULE (PRESSFIT)		
	▽=0	3 PLACES ± --- ± ---	ELO 1998/05/21			
▽=0	2 PLACES ± 0.13 ± ---	CHECKED BY DATE	molex			
	1 PLACE ± 0.25 ± ---	SMR 1998/05/21				
	0 PLACE ± --- ± ---	APPROVED BY DATE	DOCUMENT NO. SDA-73656-X00X SHEET NO. 2 OF 4			
		CAB 1998/05/21				
		ANGULAR ± 1/2° DRAFT WHERE APPLICABLE MUST REMAIN WITHIN DIMENSIONS	MATERIAL NO.	THIS DRAWING CONTAINS INFORMATION THAT IS PROPRIETARY TO MOLEX INCORPORATED AND SHOULD NOT BE USED WITHOUT WRITTEN PERMISSION		
			SEE TABLE			

9 8 7 6 5 4 3 2 1

10	9	8	7	6	5	4	3	2	1
ASSEMBLY NUMBER		FINISH (SHT 1)							
73656-5000		SEE NOTE 2.							
73656-5001		SEE NOTE 3.							

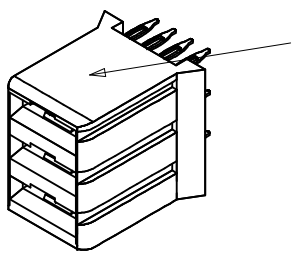

DATE CODE AND PART NUMBER ON THIS SURFACE OR SURFACE OPPOSITE.

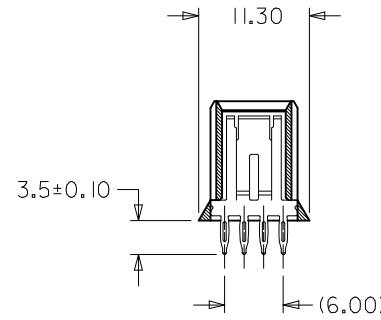
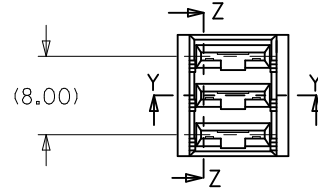

SECTION: Y-Y

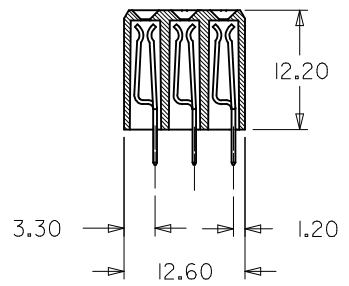

SECTION: Z-Z
ROTATED 90° CW

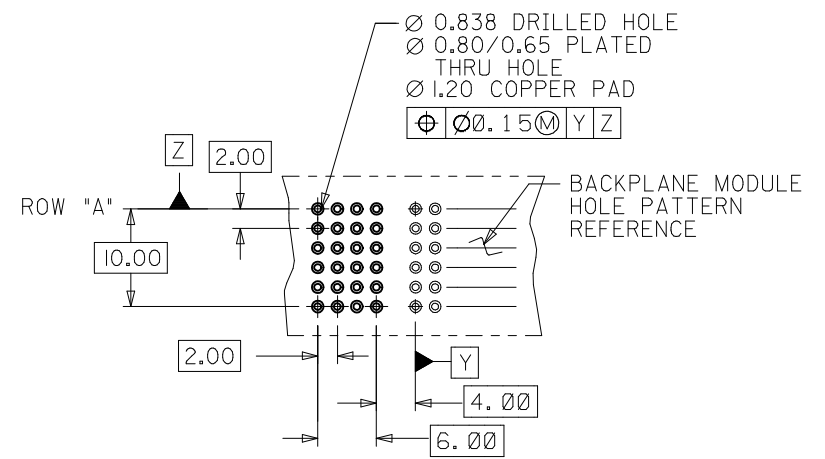
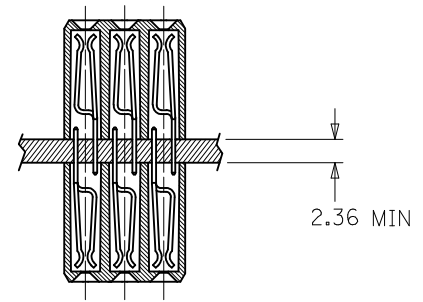

BACKPLANE MODULE HOLE PATTERN REFERENCE

SEE SHEET 1 EC NO: UCP2013-3253 DRW:RHH/PPLE 2013/02/04 CHKD:MMOLFE 2013/02/04 APPR:SMILLER 2013/08/05	QUALITY SYMBOLS	GENERAL TOLERANCES (UNLESS SPECIFIED)	DIMENSION STYLE	SCALE	DESIGN UNITS	THIRD ANGLE PROJECTION																		
	$\nabla = 0$ $\nabla = 0$ $\nabla = 0$	<table border="1"> <tr> <th></th> <th>mm</th> <th>INCH</th> </tr> <tr> <td>4 PLACES</td> <td>± ---</td> <td>± ---</td> </tr> <tr> <td>3 PLACES</td> <td>± ---</td> <td>± ---</td> </tr> <tr> <td>2 PLACES</td> <td>± 0.13</td> <td>± ---</td> </tr> <tr> <td>1 PLACE</td> <td>± 0.25</td> <td>± ---</td> </tr> <tr> <td>0 PLACE</td> <td>± ---</td> <td>± ---</td> </tr> </table>		mm	INCH	4 PLACES	± ---	± ---	3 PLACES	± ---	± ---	2 PLACES	± 0.13	± ---	1 PLACE	± 0.25	± ---	0 PLACE	± ---	± ---	MM ONLY	1:1	METRIC	
		mm	INCH																					
	4 PLACES	± ---	± ---																					
3 PLACES	± ---	± ---																						
2 PLACES	± 0.13	± ---																						
1 PLACE	± 0.25	± ---																						
0 PLACE	± ---	± ---																						
DESCRIPTION	ANGULAR ±1/2° DRAFT WHERE APPLICABLE MUST REMAIN WITHIN DIMENSIONS	DRAWN BY: ELO CHECKED BY: SMR APPROVED BY: CAB DATE: 1998/05/21	TITLE	SALES ASSY, HDM BACKPLANE POWER MODULE (PRESSFIT)																				
REV			MATERIAL NO.	DOCUMENT NO.		SHEET NO.																		
			SEE TABLE	SDA-73656-X00X		3 OF 4																		
			SIZE B	THIS DRAWING CONTAINS INFORMATION THAT IS PROPRIETARY TO MOLEX INCORPORATED AND SHOULD NOT BE USED WITHOUT WRITTEN PERMISSION																				

10	9	8	7	6	5	4	3	2	1
ASSEMBLY NUMBER		FINISH							
73656-0180		SEE NOTE 2.							
73656-0181		SEE NOTE 3.							

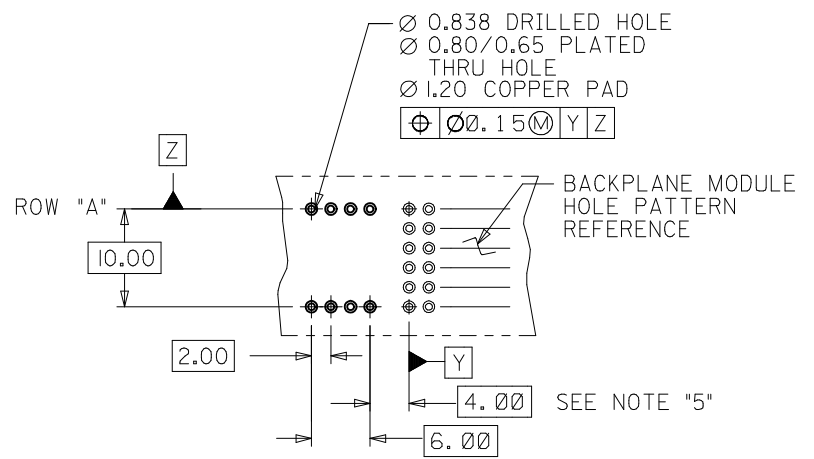
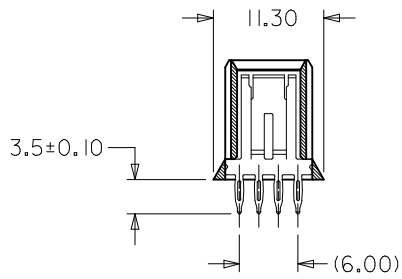
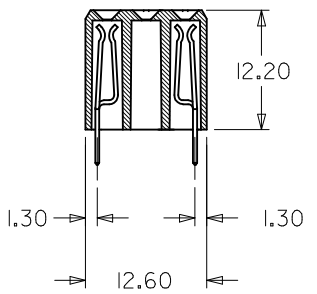
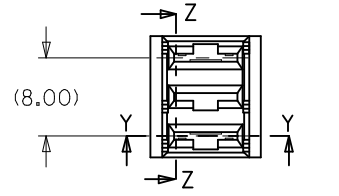
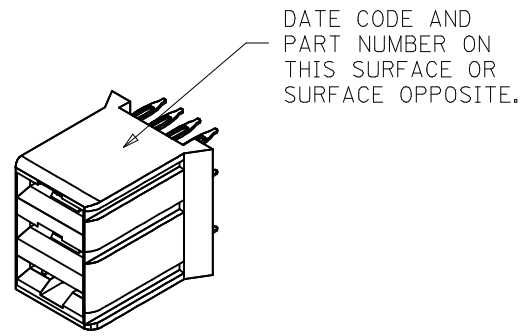

SEE SHEET 1 EC NO: UCP2013-3253 DRWN:RHH/PPLE 2013/02/04 CHKD:MMOLFE 2013/02/04 APPR:SMILLER 2013/08/05	QUALITY SYMBOLS ▽=0 ▽=0 ▽=0	GENERAL TOLERANCES (UNLESS SPECIFIED)		DIMENSION STYLE MM ONLY		SCALE 1:1	DESIGN UNITS METRIC	THIRD ANGLE PROJECTION		
			m/m	INCH	DRAWN BY ELO	DATE 1998/05/21	TITLE SALES ASSY , HDM BACKPLANE POWER MODULE (PRESSFIT)			
		4 PLACES ± --- ± ---			CHECKED BY	DATE 1998/05/21				
		3 PLACES ± --- ± ---			SMR	DATE 1998/05/21	molex			
2 PLACES ± 0.13 ± ---			APPROVED BY CAB	DATE 1998/05/21						
1 PLACE ± 0.25 ± ---			MATERIAL NO.		DOCUMENT NO.		SHEET NO.			
0 PLACE ± --- ± ---			SEE TABLE		SDA-73656-X00X		4 OF 4			
ANGULAR ±1/2° DRAFT WHERE APPLICABLE MUST REMAIN WITHIN DIMENSIONS		THIS DRAWING CONTAINS INFORMATION THAT IS PROPRIETARY TO MOLEX INCORPORATED AND SHOULD NOT BE USED WITHOUT WRITTEN PERMISSION								