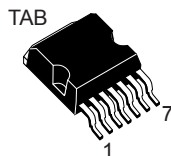
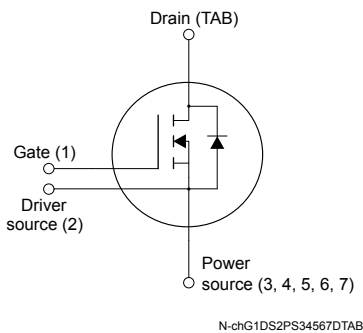

Silicon carbide Power MOSFET 650 V, 116 A, 18 mΩ (typ., $T_J = 25\text{ °C}$) in an H²PAK-7 package

H²PAK-7

Product status link
[SCTH90N65G2V-7](#)
Product summary

Order code	SCTH90N65G2V-7
Marking	SCT90N65
Package	H ² PAK-7
Packing	Tape and reel

Features

Order code	V_{DS}	$R_{DS(on)}$ max.	I_D
SCTH90N65G2V-7	650 V	24 mΩ	116 A

- Very high operating junction temperature capability ($T_J = 175\text{ °C}$)
- Very fast and robust intrinsic body diode
- Extremely low gate charge and input capacitances

Applications

- Switching applications
- Power supply for renewable energy systems
- High frequency DC-DC converters

Description

This silicon carbide Power MOSFET device has been developed using ST's advanced and innovative 2nd generation SiC MOSFET technology. The device features remarkably low on-resistance per unit area and very good switching performance. The variation of switching loss is almost independent of junction temperature.

1 Electrical ratings

Table 1. Absolute maximum ratings

Symbol	Parameter	Value	Unit
V_{DS}	Drain-source voltage	650	V
V_{GS}	Gate-source voltage	-10 to 22	V
	Gate-source voltage (recommended operating values)	-5 to 18	
I_D	Drain current (continuous) at $T_C = 25\text{ °C}$	116	A
	Drain current (continuous) at $T_C = 100\text{ °C}$	82	
$I_{DM}^{(1)}$	Drain current (pulsed)	220	A
P_{TOT}	Total power dissipation at $T_C = 25\text{ °C}$	484	W
T_{stg}	Storage temperature range	-55 to 175	°C
T_J	Operating junction temperature range		°C

1. Pulse width is limited by safe operating area.

Table 2. Thermal data

Symbol	Parameter	Value	Unit
$R_{thj-case}$	Thermal resistance junction-case	0.31	°C/W
$R_{thj-amb}$	Thermal resistance junction-ambient	40	°C/W

2 Electrical characteristics

($T_C = 25\text{ °C}$ unless otherwise specified).

Table 3. On/off states

Symbol	Parameter	Test conditions	Min.	Typ.	Max.	Unit
$V_{(BR)DSS}$	Drain-source breakdown voltage	$V_{GS} = 0\text{ V}, I_D = 1\text{ mA}$	650			V
I_{DSS}	Zero gate voltage drain current	$V_{DS} = 650\text{ V}, V_{GS} = 0\text{ V}$			10	μA
		$V_{DS} = 650\text{ V}, V_{GS} = 0\text{ V}, T_J = 150\text{ °C}$		10		
I_{GSS}	Gate-body leakage current	$V_{DS} = 0\text{ V}, V_{GS} = -10\text{ to }22\text{ V}$			± 100	nA
$V_{GS(th)}$	Gate threshold voltage	$V_{DS} = V_{GS}, I_D = 1\text{ mA}$	1.9	3.2	5.0	V
$R_{DS(on)}$	Static drain-source on-resistance	$V_{GS} = 18\text{ V}, I_D = 50\text{ A}$		18	24	m Ω
		$V_{GS} = 18\text{ V}, I_D = 50\text{ A}, T_J = 175\text{ °C}$		27		

Table 4. Dynamic

Symbol	Parameter	Test conditions	Min.	Typ.	Max.	Unit
C_{iss}	Input capacitance	$V_{DS} = 400\text{ V}, f = 1\text{ MHz}, V_{GS} = 0\text{ V}$	-	3380	-	pF
C_{oss}	Output capacitance		-	294	-	pF
C_{rSS}	Reverse transfer capacitance		-	49	-	pF
Q_g	Total gate charge	$V_{DD} = 400\text{ V}, I_D = 50\text{ A}, V_{GS} = -5\text{ to }18\text{ V}$	-	157	-	nC
Q_{gs}	Gate-source charge		-	43	-	nC
Q_{gd}	Gate-drain charge		-	42	-	nC
R_g	Gate input resistance	$f = 1\text{ MHz}, I_D = 0\text{ A}$	-	1	-	Ω

Table 5. Switching energy (inductive load)

Symbol	Parameter	Test conditions	Min.	Typ.	Max.	Unit
E_{on}	Turn-on switching energy	$V_{GS} = -5\text{ to }18\text{ V}, V_{DD} = 400\text{ V}, I_D = 50\text{ A},$ $R_G = 2.2\text{ }\Omega$	-	130	-	μJ
E_{off}	Turn-off switching energy		-	210	-	
E_{on}	Turn-on switching energy	$V_{GS} = -5\text{ to }18\text{ V}, V_{DD} = 400\text{ V}, I_D = 50\text{ A},$ $R_G = 2.2\text{ }\Omega, T_C = 150\text{ °C}$	-	135	-	
E_{off}	Turn-off switching energy		-	200	-	

Table 6. Switching times

Symbol	Parameter	Test conditions	Min.	Typ.	Max.	Unit
$t_{d(on)}$	Turn-on delay time	$V_{DD} = 400\text{ V}$, $I_D = 50\text{ A}$, $R_G = 2.2\ \Omega$, $V_{GS} = -5\text{ to }18\text{ V}$	-	26	-	ns
t_f	Fall time		-	16	-	ns
$t_{d(off)}$	Turn-off delay time		-	58	-	ns
t_r	Rise time		-	38	-	ns

Table 7. Reverse SiC diode characteristics

Symbol	Parameter	Test conditions	Min.	Typ.	Max.	Unit
V_{SD}	Forward on voltage	$I_F = 30\text{ A}$, $V_{GS} = 0\text{ V}$	-	2.5	-	V
t_{rr}	Reverse recovery time	$I_F = 50\text{ A}$, $di/dt = 4000\text{ A}/\mu\text{s}$, $V_{DD} = 400\text{ V}$	-	17	-	ns
Q_{rr}	Reverse recovery charge		-	308	-	nC
I_{RRM}	Reverse recovery current		-	30	-	A

2.1 Electrical characteristics (curves)

Figure 1. Safe operating area

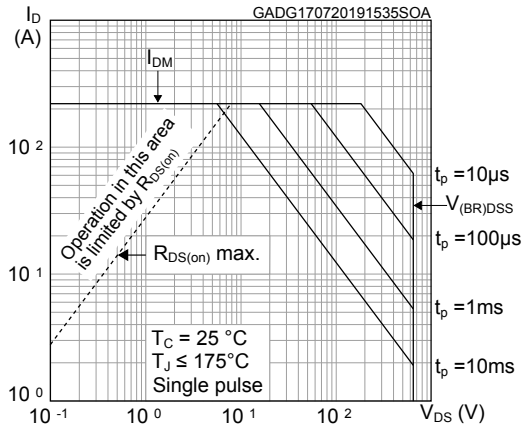

Figure 2. Maximum transient thermal impedance

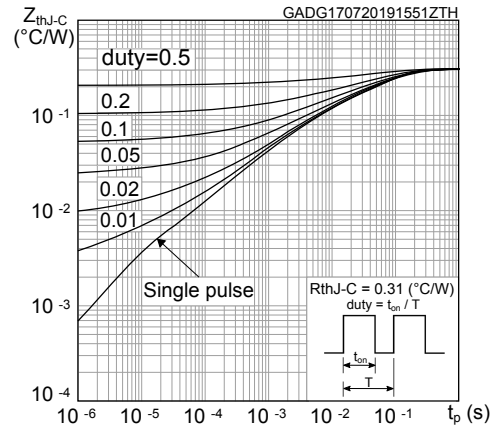

Figure 3. Typical output characteristics ($T_J = -50\text{ °C}$)

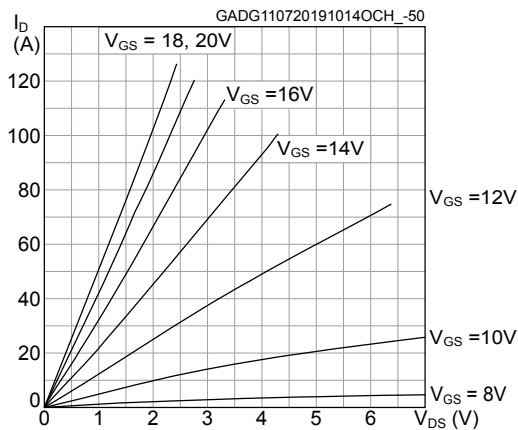

Figure 4. Typical output characteristics ($T_J = 25\text{ °C}$)

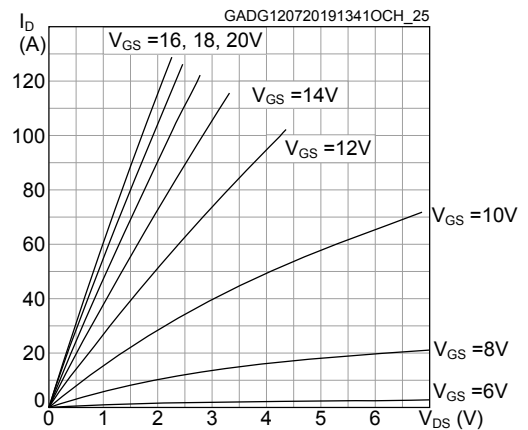

Figure 5. Typical output characteristics ($T_J = 175\text{ °C}$)

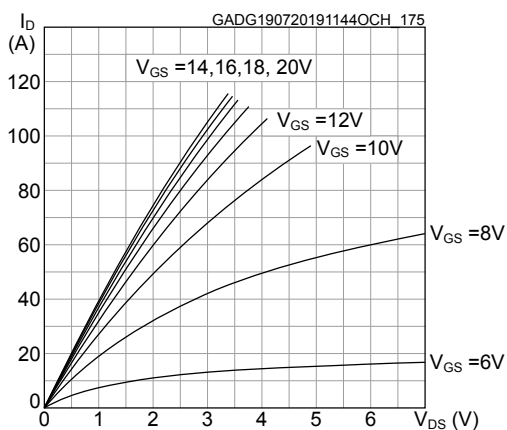

Figure 6. Typical transfer characteristics

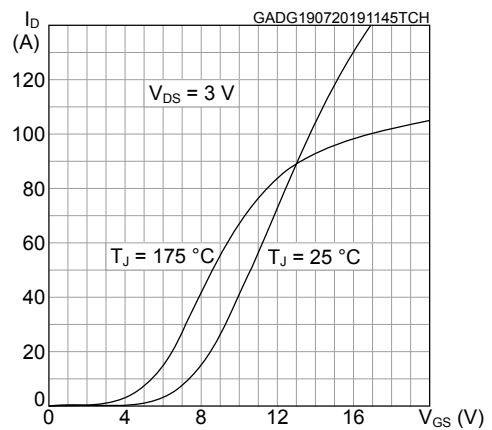

Figure 7. Typical capacitances

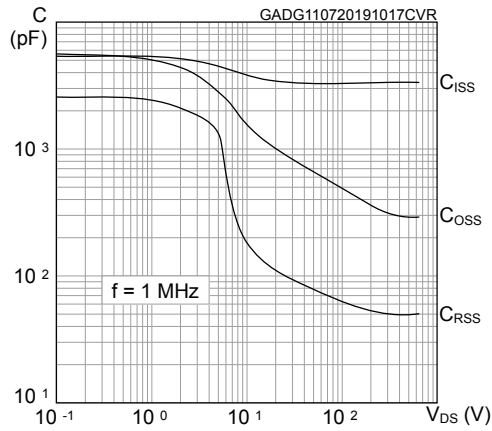

Figure 8. Typical gate charge

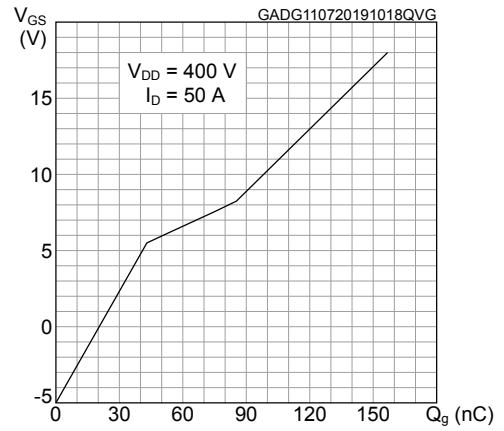

Figure 9. Maximum total power dissipation

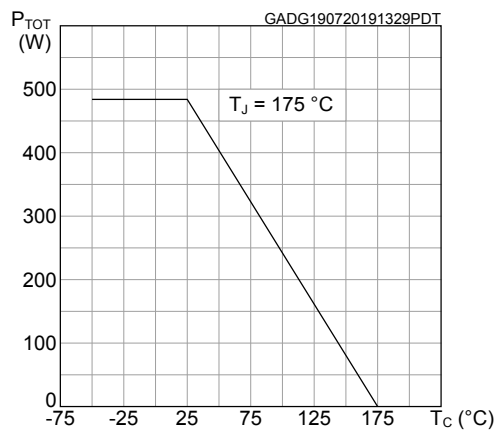

Figure 10. Typical drain-source on-resistance

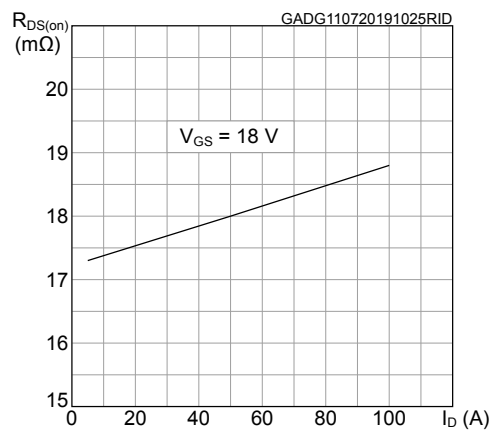

Figure 11. Normalized on-resistance vs temperature

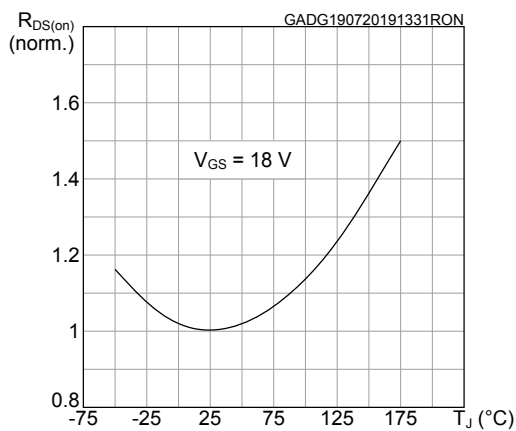

Figure 12. Normalized gate threshold voltage vs temperature

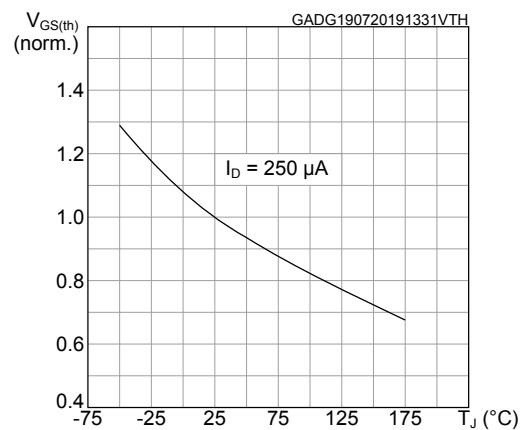

Figure 13. Normalized breakdown voltage vs temperature

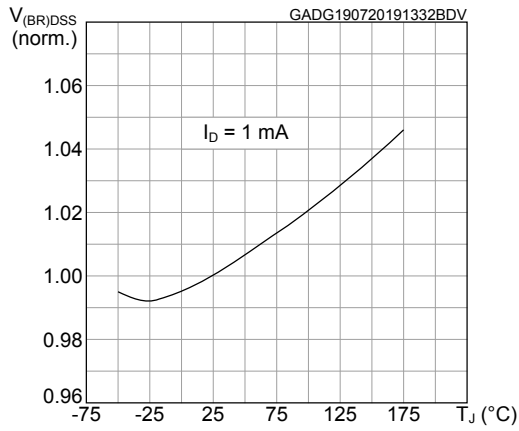

Figure 14. Typical switching energy vs drain current

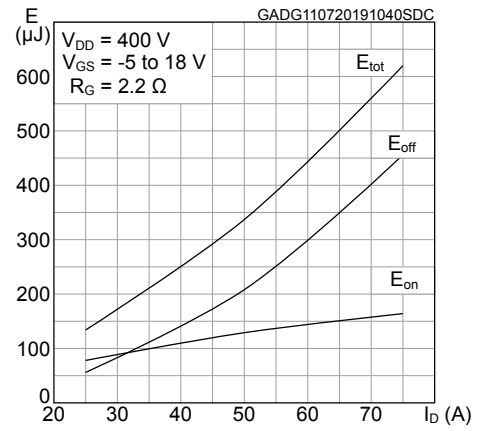

Figure 15. Typical switching energy vs temperature

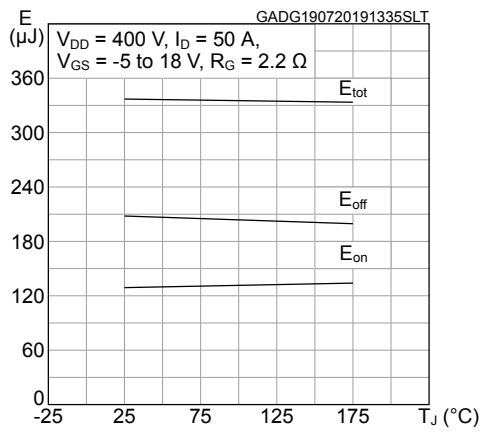

Figure 16. Typical reverse conduction characteristics (Tj = -50 °C)

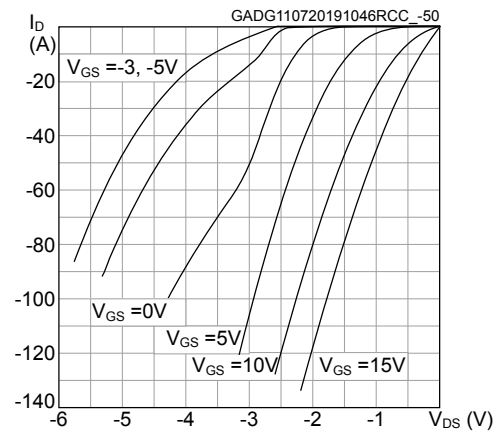

Figure 17. Typical reverse conduction characteristics (Tj = 25 °C)

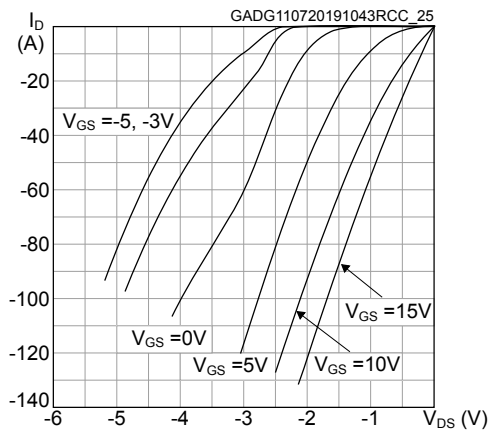
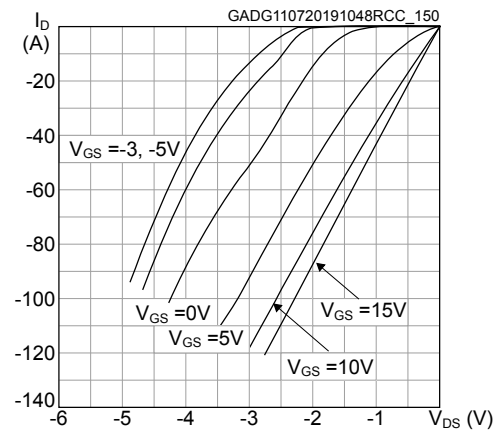

Figure 18. Typical reverse conduction characteristics (Tj = 150 °C)



3 Package information

In order to meet environmental requirements, ST offers these devices in different grades of **ECOPACK** packages, depending on their level of environmental compliance. ECOPACK specifications, grade definitions and product status are available at: www.st.com. ECOPACK is an ST trademark.

3.1 H²PAK-7 package information

Figure 19. H²PAK-7 package outline

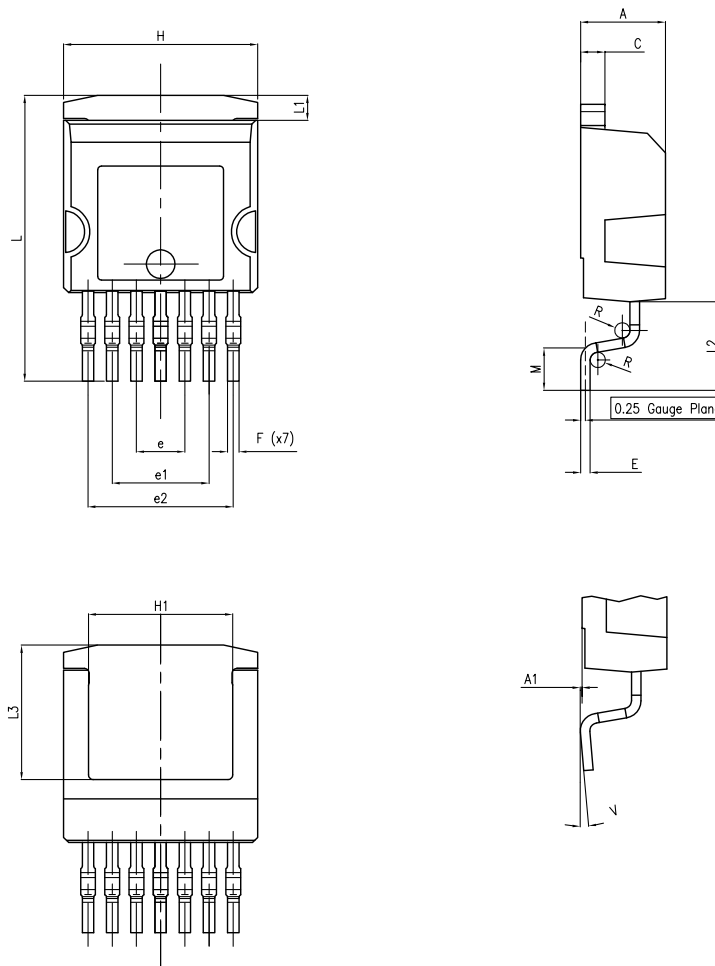

DM00249216_4

Table 8. H²PAK-7 package mechanical data

Dim.	mm	
	Min.	Max.
A	4.30	4.80
A1	0.03	0.20
C	1.17	1.37
e	2.34	2.74
e1	4.88	5.28
e2	7.42	7.82
E	0.45	0.60
F	0.50	0.70
H	10.00	10.40
H1	7.40	7.60
L	14.75	15.25
L1	1.27	1.40
L2	4.35	4.95
L3	6.85	7.25
M	1.90	2.50
R	0.20	0.60
V	0°	8°

Figure 20. H²PAK-7 recommended footprint

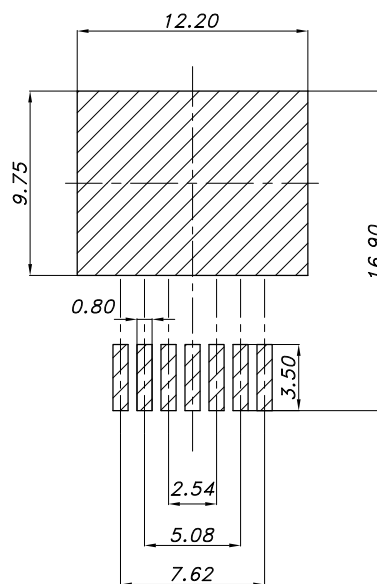

footprint_DM00249216_4

Note: Dimensions are in mm.

3.2 Packing information

Figure 21. Tape outline

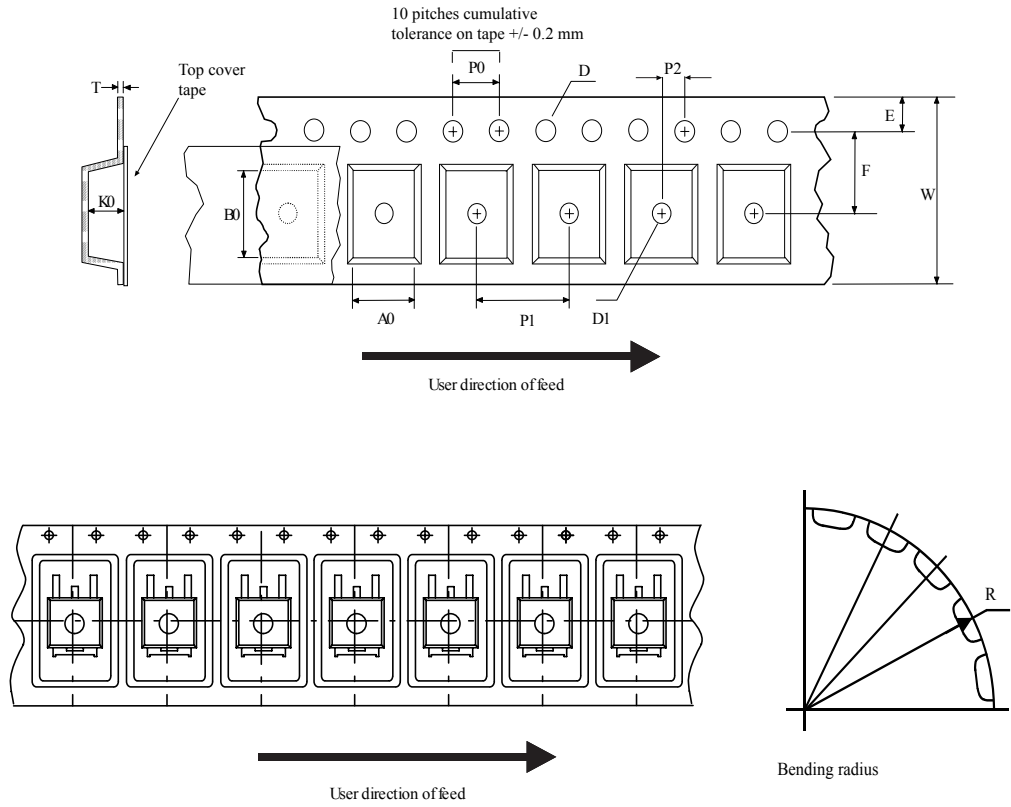

AM08852v2

Figure 22. Reel outline

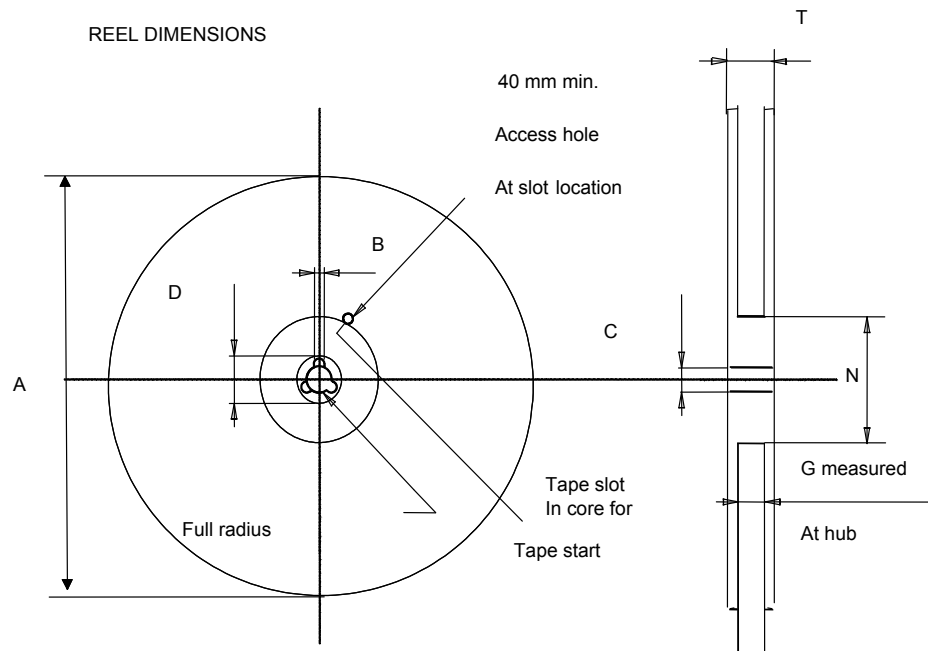

Table 9. Tape and reel mechanical data

Dim.	Tape		Dim.	Reel	
	mm			mm	
	Min.	Max.		Min.	Max.
A0	10.5	10.7	A		330
B0	15.7	15.9	B	1.5	
D	1.5	1.6	C	12.8	13.2
D1	1.59	1.61	D	20.2	
E	1.65	1.85	G	24.4	26.4
F	11.4	11.6	N	100	
K0	4.8	5.0	T		30.4
P0	3.9	4.1			
P1	11.9	12.1	Base quantity		1000
P2	1.9	2.1	Bulk quantity		1000
R	50				
T	0.25	0.35			
W	23.7	24.3			

Revision history

Table 10. Document revision history

Date	Revision	Changes
30-Mar-2017	1	First release
28-Jun-2018	2	Updated cover page. Updated <i>Section 2 Electrical characteristics</i> and <i>Section 3 Package information</i> . Minor text changes.
22-Jan-2019	3	Updated title and <i>features</i> on cover page. Updated <i>Table 1. Absolute maximum ratings</i> . Updated <i>Section 2 Electrical characteristics</i> and <i>Section 2.1 Electrical characteristics (curves)</i> . Minor text changes.
19-Jul-2019	4	Updated Section 1 Electrical ratings . Updated Section 2 Electrical characteristics and Section 2.1 Electrical characteristics (curves) . Minor text changes.

Contents

1	Electrical ratings	2
2	Electrical characteristics	3
2.1	Electrical characteristics (curves)	5
3	Package information	8
3.1	H ² PAK-7 package information	8
3.2	Packing information	9
	Revision history	12

IMPORTANT NOTICE – PLEASE READ CAREFULLY

STMicroelectronics NV and its subsidiaries (“ST”) reserve the right to make changes, corrections, enhancements, modifications, and improvements to ST products and/or to this document at any time without notice. Purchasers should obtain the latest relevant information on ST products before placing orders. ST products are sold pursuant to ST’s terms and conditions of sale in place at the time of order acknowledgement.

Purchasers are solely responsible for the choice, selection, and use of ST products and ST assumes no liability for application assistance or the design of Purchasers’ products.

No license, express or implied, to any intellectual property right is granted by ST herein.

Resale of ST products with provisions different from the information set forth herein shall void any warranty granted by ST for such product.

ST and the ST logo are trademarks of ST. For additional information about ST trademarks, please refer to www.st.com/trademarks. All other product or service names are the property of their respective owners.

Information in this document supersedes and replaces information previously supplied in any prior versions of this document.

© 2019 STMicroelectronics – All rights reserved