

Data sheet | Item number: 2002-2708

Double-deck terminal block; 4-conductor through terminal block; L; without marker carrier; suitable for Ex e II applications; internal commoning; conductor entry with violet marking; for DIN-rail 35 x 15 and 35 x 7.5; 2.5 mm²; Push-in CAGE CLAMP®; 2,50 mm²; gray

www.wago.com/2002-2708

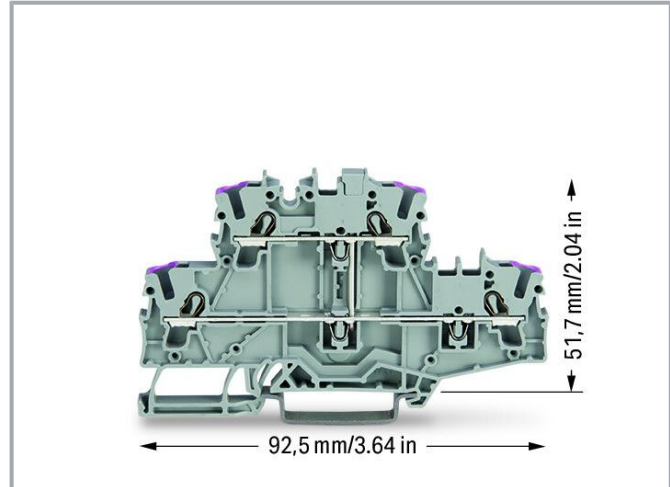
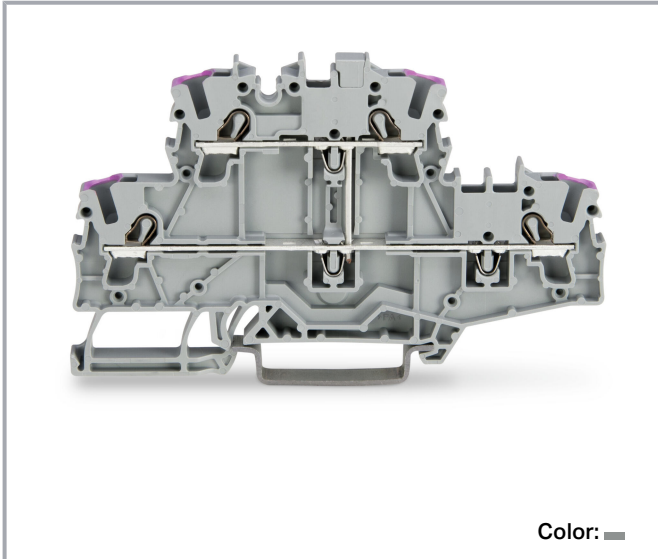

Color: ■

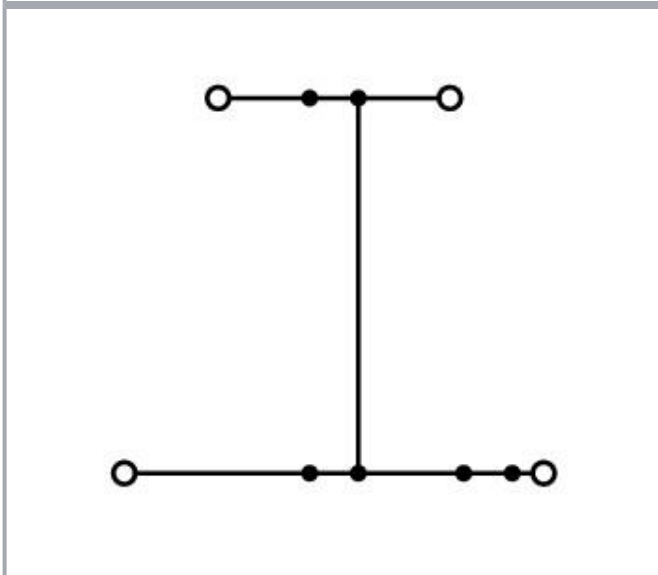

Data

Electrical data

Subject to changes. Please also observe the further product documentation!

WAGO GmbH & Co. KG
Hansastr. 27
32423 Minden
Phone: +49571 887-0 | Fax: +49571 887-169
Email: info.de@wago.com | Web: www.wago.com

Do you have any questions about our products?
We are always happy to take your call at +49 (571) 887-44222.



Ratings per IEC/EN

Ratings per	IEC/EN 60947-7-1
Nominal voltage (III/3)	800 V
Rated impulse voltage (III/3)	8 kV
Rated current	24 A
Current at conductor cross-section (max.) mm ²	28 A
Legend (ratings)	(III / 3) $\hat{=}$ Overvoltage category III / Pollution degree 3

Ratings per UL 1059

Approvals per	UL 1059
Rated voltage UL (Use Group B)	600 V
Rated current UL (Use Group B)	20 A
Rated voltage UL (Use Group C)	600 V
Rated current UL (Use Group C)	20 A

Ratings per CSA

Approvals per	CSA 22.2 No 158
Rated voltage CSA (Use Group B)	600 V
Rated current CSA (Use Group B)	24 A
Rated voltage CSA (Use Group C)	600 V
Rated current CSA (Use Group C)	24 A

Ex information

Reference hazardous areas	See "Downloads – Documentation – Additional Information: Technical Section; Technical Explications"
Ratings per	ATEX: PTB 03 ATEX 1162 U / IECEx: PTB 03.0004U (Ex eb IIC Gb)
Rated voltage EN (Ex e II)	550 V
Rated current (Ex e II)	17.5 A
Rated current (Ex e II) with jumper	17 A

Power loss

Power loss, per pole (potential)	0.766 W
Rated current I_N for specified power loss	24 A
Resistance value for specified, current-dependent power loss	0.001 Ω

Subject to changes. Please also observe the further product documentation!



Connection data

Connection points	4
Total number of potentials	1
Number of levels	2
Number of jumper slots	3
Anzahl Brückeraufnahmen Rang	2

Connection 1

Connection technology	Push-in CAGE CLAMP®
Actuation type	Operating tool
Connectable conductor materials	Copper
Nominal cross-section	2.5 mm ²
Solid conductor	0.25 ... 4 mm ² / 22 ... 12 AWG
Solid conductor; push-in termination	0.75 ... 4 mm ² / 18 ... 12 AWG
Fine-stranded conductor	0.25 ... 4 mm ² / 22 ... 12 AWG
Fine-stranded conductor; with insulated ferrule	0.25 ... 2.5 mm ² / 22 ... 14 AWG
Fine-stranded conductor; with ferrule; push-in termination	1 ... 2.5 mm ² / 18 ... 14 AWG
Note (conductor cross-section)	Depending on the conductor characteristic, a conductor with a smaller cross-section can also be inserted via push-in termination.
Strip length	10 ... 12 mm / 0.39 ... 0.47 inches
Wiring direction	Front-entry wiring

Physical data

Width	5.2 mm / 0.205 inches
Height	92.5 mm / 3.642 inches
Depth from upper-edge of DIN-rail	51.7 mm / 2.035 inches

Mechanical Data

Potential marking	L
Mounting type	DIN-35 rail
Marking level	Center/side marking

Material Data

Note (material data)

[Information on material specifications can be found here](#)

Subject to changes. Please also observe the further product documentation!

Color	gray
Material group	I
Insulation material	Polyamide (PA66)
Flammability class per UL94	V0
Fire load	0.257 MJ
Weight	13 g

Environmental requirements

Processing temperature	-35 ... +85 °C
Continuous operating temperature	-60 ... +105 °C

Commercial data



eCl@ss 10.0	27-14-11-20
eCl@ss 9.0	27-14-11-20
ETIM 8.0	EC000897
ETIM 7.0	EC000897
PU (SPU)	50 pcs
Packaging type	box
Country of origin	DE
GTIN	4055143622554
Customs tariff number	85369010000

Environmental Product Compliance

RoHS Compliance Status	Compliant, No Exemption
------------------------	-------------------------

Approvals / Certificates

General approvals

Logo	Approval	Additional Approval Text	Certificate name
	CCA DEKRA Certification B.V.	EN 60947	71- 120369
	CCA DEKRA Certification B.V.	EN 60947	NTR NL 7892
	CSA	C22.2 No. 158	1536069

Subject to changes. Please also observe the further product documentation!



DEKRA Certification B.V.





UL
Underwriters Laboratories Inc.

UL 1059

E45172

Declarations of conformity and manufacturer's declarations

Logo	Approval	Additional Approval Text	Certificate name
	EU-Declaration of Conformity WAGO GmbH & Co. KG	-	-
	Railway WAGO GmbH & Co. KG	-	Railway Ready
	UK-Declaration of Conformity WAGO GmbH & Co. KG	-	-

Approvals for hazardous areas

Logo	Approval	Additional Approval Text	Certificate name
	AEx Underwriters Laboratories Inc.	UL 60079	E185892 (AEx eb IIC resp. Ex eb IIC)
	ATEX Physikalisch Technische Bundesanstalt	EN 60079	PTB 03 ATEX 1162 U (II2G Ex eb IIC Gb, IM2 Ex eb IMb)

Required accessories

End plate

End plate

Subject to changes. Please also observe the further product documentation!

WAGO GmbH & Co. KG
Hansastr. 27
32423 Minden
Phone: +49571 887-0 | Fax: +49571 887-169
Email: info.de@wago.com | Web: www.wago.com

Do you have any questions about our products?
We are always happy to take your call at +49 (571) 887-44222.



Item no.: 2002-2791
End plate; 0.8 mm thick; gray

www.wago.com/2002-2791



Item no.: 2002-2792
End plate; 0.8 mm thick; orange

www.wago.com/2002-2792

Optional accessories

Carrier rail

Mounting accessories



Item no.: 210-197
Steel carrier rail; 35 x 15 mm; 1.5 mm thick; 2 m long; slotted; similar to EN 60715; silver-colored

www.wago.com/210-197

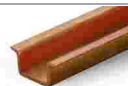

Item no.: 210-198
Copper carrier rail; 35 x 15 mm; 2.3 mm thick; 2 m long; unslotted; according to EN 60715; copper-colored

www.wago.com/210-198



Item no.: 210-504
Steel carrier rail; 35 x 7.5 mm; 1 mm thick; 2 m long; slotted; galvanized; according to EN 60715; silver-colored

www.wago.com/210-504



Item no.: 210-505
Steel carrier rail; 35 x 7.5 mm; 1 mm thick; 2 m long; unslotted; galvanized; according to EN 60715; silver-colored

www.wago.com/210-505



Item no.: 210-506
Steel carrier rail; 35 x 15 mm; 1.5 mm thick; 2 m long; unslotted; galvanized; similar to EN 60715; silver-colored

www.wago.com/210-506



Item no.: 210-508
Steel carrier rail; 35 x 15 mm; 1.5 mm thick; 2 m long; slotted; galvanized; similar to EN 60715; silver-colored

www.wago.com/210-508



Item no.: 210-113
Steel carrier rail; 35 x 7.5 mm; 1 mm thick; 2 m long; unslotted; according to EN 60715; silver-colored

www.wago.com/210-113

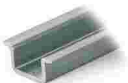

Item no.: 210-118
Steel carrier rail; 35 x 15 mm; 2.3 mm thick; 2 m long; unslotted; according to EN 60715; silver-colored

www.wago.com/210-118



Item no.: 210-112
Steel carrier rail; 35 x 7.5 mm; 1 mm thick; 2 m long; slotted; according to EN 60715; "Hole width 25 mm; silver-colored

www.wago.com/210-112



Item no.: 210-114
Steel carrier rail; 35 x 15 mm; 1.5 mm thick; 2 m long; unslotted; similar to EN 60715; silver-colored

www.wago.com/210-114



Item no.: 210-115
Steel carrier rail; 35 x 7.5 mm; 1 mm thick; 2 m long; slotted; according to EN 60715; "Hole width 18 mm; silver-colored

www.wago.com/210-115

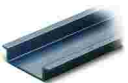

Item no.: 210-196
Aluminum carrier rail; 35 x 8.2 mm; 1.6 mm thick; 2 m long; unslotted; similar to EN 60715; silver-colored

www.wago.com/210-196

Subject to changes. Please also observe the further product documentation!

WAGO GmbH & Co. KG

Hansastr. 27













32423 Minden

Phone: +49571 887-0 | Fax: +49571 887-169













Email: info.de@wago.com | Web: www.wago.com

Do you have any questions about our products?













We are always happy to take your call at +49 (571) 887-44222.

Ferrule		
Ferrule		
	Item no.: 216-241 Ferrule; Sleeve for 0.5 mm ² / 20 AWG; insulated; electro-tin plated; electrolytic copper; gastight crimped; acc. to DIN 46228, Part 4/09.90; white	www.wago.com/216-241
	Item no.: 216-242 Ferrule; Sleeve for 0.75 mm ² / 18 AWG; insulated; electro-tin plated; electrolytic copper; gastight crimped; acc. to DIN 46228, Part 4/09.90; gray	www.wago.com/216-242
	Item no.: 216-243 Ferrule; Sleeve for 1 mm ² / AWG 18; insulated; electro-tin plated; electrolytic copper; gastight crimped; acc. to DIN 46228, Part 4/09.90; red	www.wago.com/216-243
	Item no.: 216-244 Ferrule; Sleeve for 1.5 mm ² / AWG 16; insulated; electro-tin plated; electrolytic copper; gastight crimped; acc. to DIN 46228, Part 4/09.90; black	www.wago.com/216-244
	Item no.: 216-263 Ferrule; Sleeve for 1 mm ² / AWG 18; insulated; electro-tin plated; electrolytic copper; gastight crimped; acc. to DIN 46228, Part 4/09.90; red	www.wago.com/216-263
	Item no.: 216-246 Ferrule; Sleeve for 2.5 mm ² / AWG 14; insulated; electro-tin plated; electrolytic copper; gastight crimped; acc. to DIN 46228, Part 4/09.90; blue	www.wago.com/216-246
	Item no.: 216-266 Ferrule; Sleeve for 2.5 mm ² / AWG 14; insulated; electro-tin plated; electrolytic copper; gastight crimped; acc. to DIN 46228, Part 4/09.90; blue	www.wago.com/216-266
	Item no.: 216-264 Ferrule; Sleeve for 1.5 mm ² / AWG 16; insulated; electro-tin plated; electrolytic copper; gastight crimped; acc. to DIN 46228, Part 4/09.90; black	www.wago.com/216-264
	Item no.: 216-262 Ferrule; Sleeve for 0.75 mm ² / 18 AWG; insulated; electro-tin plated; electrolytic copper; gastight crimped; acc. to DIN 46228, Part 4/09.90; gray	www.wago.com/216-262
Insulation stop		
Insulation stop		
	Item no.: 2002-171 Insulation stop; 0.25 - 0.5 mm ² ; 5 pieces/strip; light gray	www.wago.com/2002-171
	Item no.: 2002-172 Insulation stop; 0.75 - 1 mm ² ; 5 pieces/strip; dark gray	www.wago.com/2002-172
End plate		
End plate		
	Item no.: 209-192 Separator for Ex e/Ex i applications; 3 mm thick; 125.5 mm wide; orange	www.wago.com/209-192
Marking accessories		
Marking strip		

Subject to changes. Please also observe the further product documentation!

	Item no.: 2009-110 Marking strips; for Smart Printer; on reel; not stretchable; plain; snap-on type; white	www.wago.com/2009-110
Marker carrier		
	Item no.: 2009-198 Adaptor; gray	www.wago.com/2009-198
	Item no.: 2002-121 Adaptor; gray	www.wago.com/2002-121
	Item no.: 2002-161 Adaptor; gray	www.wago.com/2002-161
Marker		
	Item no.: 2009-115/000-002 WMB-Inline; for Smart Printer; 1500 pieces on roll; stretchable 5 - 5.2 mm; plain; snap-on type; yellow	www.wago.com/2009-115/000-002
	Item no.: 2009-115/000-007 WMB-Inline; for Smart Printer; 1500 pieces on roll; stretchable 5 - 5.2 mm; plain; snap-on type; gray	www.wago.com/2009-115/000-007
	Item no.: 2009-115/000-017 WMB-Inline; for Smart Printer; 1500 pieces on roll; stretchable 5 - 5.2 mm; plain; snap-on type; light green	www.wago.com/2009-115/000-017
	Item no.: 2009-115/000-023 WMB-Inline; for Smart Printer; 1500 pieces on roll; stretchable 5 - 5.2 mm; plain; snap-on type; green	www.wago.com/2009-115/000-023
	Item no.: 2009-115/000-024 WMB-Inline; for Smart Printer; 1500 pieces on roll; stretchable 5 - 5.2 mm; plain; snap-on type; violet	www.wago.com/2009-115/000-024
	Item no.: 2009-145/000-006 Mini-WSB Inline; for Smart Printer; 1700 pieces on roll; stretchable 5 - 5.2 mm; plain; snap-on type; blue	www.wago.com/2009-145/000-006
	Item no.: 2009-145 Mini-WSB Inline; for Smart Printer; 1700 pieces on roll; stretchable 5 - 5.2 mm; plain; snap-on type; white	www.wago.com/2009-145
	Item no.: 2009-145/000-002 Mini-WSB Inline; for Smart Printer; 1700 pieces on roll; stretchable 5 - 5.2 mm; plain; snap-on type; yellow	www.wago.com/2009-145/000-002
	Item no.: 2009-145/000-007 Mini-WSB Inline; for Smart Printer; 1700 pieces on roll; stretchable 5 - 5.2 mm; plain; snap-on type; gray	www.wago.com/2009-145/000-007

Subject to changes. Please also observe the further product documentation!

	Item no.: 2009-145/000-005 Mini-WSB Inline; for Smart Printer; 1700 pieces on roll; stretchable 5 - 5.2 mm; plain; snap-on type; red	www.wago.com/2009-145/000-005
	Item no.: 2009-145/000-012 Mini-WSB Inline; for Smart Printer; 1700 pieces on roll; stretchable 5 - 5.2 mm; plain; snap-on type; orange	www.wago.com/2009-145/000-012
	Item no.: 2009-145/000-023 Mini-WSB Inline; for Smart Printer; 1700 pieces on roll; stretchable 5 - 5.2 mm; plain; snap-on type; green	www.wago.com/2009-145/000-023
	Item no.: 2009-145/000-024 Mini-WSB Inline; for Smart Printer; 1700 pieces on roll; stretchable 5 - 5.2 mm; plain; snap-on type; violet	www.wago.com/2009-145/000-024
	Item no.: 2009-115 WMB-Inline; for Smart Printer; 1500 pieces on roll; stretchable 5 - 5.2 mm; plain; snap-on type; white	www.wago.com/2009-115
	Item no.: 248-501/000-006 Mini-WSB marking card; as card; not stretchable; plain; snap-on type; blue	www.wago.com/248-501/000-006
	Item no.: 248-501/000-007 Mini-WSB marking card; as card; not stretchable; plain; snap-on type; gray	www.wago.com/248-501/000-007
	Item no.: 248-501/000-002 Mini-WSB marking card; as card; not stretchable; plain; snap-on type; yellow	www.wago.com/248-501/000-002
	Item no.: 248-501/000-012 Mini-WSB marking card; as card; not stretchable; plain; snap-on type; orange	www.wago.com/248-501/000-012
	Item no.: 248-501 Mini-WSB marking card; as card; not stretchable; plain; snap-on type; white	www.wago.com/248-501
	Item no.: 248-501/000-017 Mini-WSB marking card; as card; not stretchable; plain; snap-on type; light green	www.wago.com/248-501/000-017
	Item no.: 248-501/000-005 Mini-WSB marking card; as card; not stretchable; plain; snap-on type; red	www.wago.com/248-501/000-005

Subject to changes. Please also observe the further product documentation!



Item no.: 248-501/000-024

Mini-WSB marking card; as card; not stretchable; plain; snap-on type; violet

www.wago.com/248-501/000-024



Item no.: 248-501/000-023

Mini-WSB marking card; as card; not stretchable; plain; snap-on type; green

www.wago.com/248-501/000-023



Item no.: 793-5501/000-007

WMB marking card; as card; for terminal block width 5 - 17.5 mm; stretchable 5 - 5.2 mm; plain; snap-on type; gray

www.wago.com/793-5501/000-007



Item no.: 793-5501/000-012

WMB marking card; as card; for terminal block width 5 - 17.5 mm; stretchable 5 - 5.2 mm; plain; snap-on type; orange

www.wago.com/793-5501/000-012

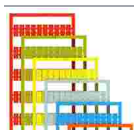

Item no.: 793-5501/000-014

WMB marking card; as card; for terminal block width 5 - 17.5 mm; stretchable 5 - 5.2 mm; plain; snap-on type; brown

www.wago.com/793-5501/000-014

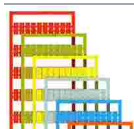

Item no.: 793-5501/000-017

WMB marking card; as card; for terminal block width 5 - 17.5 mm; stretchable 5 - 5.2 mm; plain; snap-on type; light green

www.wago.com/793-5501/000-017

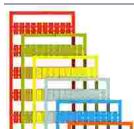

Item no.: 793-5501/000-023

WMB marking card; as card; for terminal block width 5 - 17.5 mm; stretchable 5 - 5.2 mm; plain; snap-on type; green

www.wago.com/793-5501/000-023

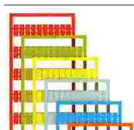

Item no.: 793-5501/000-024

WMB marking card; as card; for terminal block width 5 - 17.5 mm; stretchable 5 - 5.2 mm; plain; snap-on type; violet

www.wago.com/793-5501/000-024

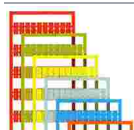

Item no.: 793-5501/000-005

WMB marking card; as card; for terminal block width 5 - 17.5 mm; stretchable 5 - 5.2 mm; plain; snap-on type; red

www.wago.com/793-5501/000-005

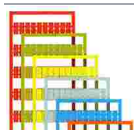

Item no.: 793-5501/000-002

WMB marking card; as card; for terminal block width 5 - 17.5 mm; stretchable 5 - 5.2 mm; plain; snap-on type; yellow

www.wago.com/793-5501/000-002

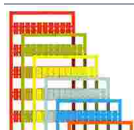















Item no.: 793-5501/000-006

WMB marking card; as card; for terminal block width 5 - 17.5 mm; stretchable 5 - 5.2 mm; plain; snap-on type; blue

www.wago.com/793-5501/000-006

Subject to changes. Please also observe the further product documentation!

	Item no.: 793-5501 WMB marking card; as card; for terminal block width 5 - 17.5 mm; stretchable 5 - 5.2 mm; plain; snap-on type; white	www.wago.com/793-5501
	Item no.: 2009-115/000-012 WMB-Inline; for Smart Printer; 1500 pieces on roll; stretchable 5 - 5.2 mm; plain; snap-on type; orange	www.wago.com/2009-115/000-012
	Item no.: 2009-115/000-006 WMB-Inline; for Smart Printer; 1500 pieces on roll; stretchable 5 - 5.2 mm; plain; snap-on type; blue	www.wago.com/2009-115/000-006
	Item no.: 2009-115/000-005 WMB-Inline; for Smart Printer; 1500 pieces on roll; stretchable 5 - 5.2 mm; plain; snap-on type; red	www.wago.com/2009-115/000-005
Group marker carrier		
	Item no.: 2009-193 Group marker carrier; gray	www.wago.com/2009-193
	Item no.: 2009-192 Group marker carrier; gray	www.wago.com/2009-192
	Item no.: 2009-191 Group marker carrier; gray	www.wago.com/2009-191
Jumpers		
Jumper		
	Item no.: 210-123 Wire commoning chain; insulated; blue	www.wago.com/210-123
	Item no.: 2002-402 Jumper; 2-way; insulated; light gray	www.wago.com/2002-402
	Item no.: 2002-402/000-005 Jumper; 2-way; insulated; red	www.wago.com/2002-402/000-005
	Item no.: 2002-400 Continuous jumper; 2-way; insulated; light gray	www.wago.com/2002-400
	Item no.: 2002-403 Jumper; 3-way; insulated; light gray	www.wago.com/2002-403
	Item no.: 2002-404/000-005 Jumper; 4-way; insulated; red	www.wago.com/2002-404/000-005
	Item no.: 2002-403/000-006 Jumper; 3-way; insulated; blue	www.wago.com/2002-403/000-006
		

Subject to changes. Please also observe the further product documentation!

Item no.: 2002-404/000-006
Jumper; 4-way; insulated; blue

www.wago.com/2002-404/000-006



Item no.: 2002-403/000-005
Jumper; 3-way; insulated; red

www.wago.com/2002-403/000-005



Item no.: 2002-405/000-005
Jumper; 5-way; insulated; red

www.wago.com/2002-405/000-005



Item no.: 2002-402/000-006
Jumper; 2-way; insulated; blue

www.wago.com/2002-402/000-006



Item no.: 2002-405/000-006
Jumper; 5-way; insulated; blue

www.wago.com/2002-405/000-006



Item no.: 2002-404
Jumper; 4-way; insulated; light gray

www.wago.com/2002-404



Item no.: 2002-406/000-006
Jumper; 6-way; insulated; blue

www.wago.com/2002-406/000-006



Item no.: 2002-406/000-005
Jumper; 6-way; insulated; red

www.wago.com/2002-406/000-005



Item no.: 2002-406/020-000
Delta jumper; insulated; light gray

www.wago.com/2002-406/020-000



Item no.: 2002-405
Jumper; 5-way; insulated; light gray

www.wago.com/2002-405



Item no.: 2002-407/000-005
Jumper; 7-way; insulated; red

www.wago.com/2002-407/000-005



Item no.: 2002-408
Jumper; 8-way; insulated; light gray

www.wago.com/2002-408

Subject to changes. Please also observe the further product documentation!



Item no.: 2002-408/000-006
Jumper; 8-way; insulated; blue

www.wago.com/2002-408/000-006



Item no.: 2002-405/011-000
Star point jumper; 3-way; insulated; light gray

www.wago.com/2002-405/011-000



Item no.: 2002-407/000-006
Jumper; 7-way; insulated; blue

www.wago.com/2002-407/000-006



Item no.: 2002-408/000-005
Jumper; 8-way; insulated; red

www.wago.com/2002-408/000-005



Item no.: 2002-407
Jumper; 7-way; insulated; light gray

www.wago.com/2002-407



Item no.: 2002-406
Jumper; 6-way; insulated; light gray

www.wago.com/2002-406



Item no.: 2002-410/000-005
Jumper; 10-way; insulated; red

www.wago.com/2002-410/000-005



Item no.: 2002-410/000-006
Jumper; 10-way; insulated; blue

www.wago.com/2002-410/000-006



Item no.: 2002-410
Jumper; 10-way; insulated; light gray

www.wago.com/2002-410



Item no.: 2002-409/000-006
Jumper; 9-way; insulated; blue

www.wago.com/2002-409/000-006



Item no.: 2002-409/000-005
Jumper; 9-way; insulated; red

www.wago.com/2002-409/000-005

















Item no.: 2002-409
Jumper; 9-way; insulated; light gray













www.wago.com/2002-409



Subject to changes. Please also observe the further product documentation!

	<p>Item no.: 2002-423/000-006 Continuous jumper; from 1 to 3; insulated; blue</p>	<p>www.wago.com/2002-423/000-006</p>
	<p>Item no.: 2002-423 Continuous jumper; from 1 to 3; insulated; light gray</p>	<p>www.wago.com/2002-423</p>
	<p>Item no.: 2002-433 Jumper; from 1 to 3; insulated; light gray</p>	<p>www.wago.com/2002-433</p>
	<p>Item no.: 2002-434 Jumper; from 1 to 4; insulated; light gray</p>	<p>www.wago.com/2002-434</p>
	<p>Item no.: 2002-423/000-005 Continuous jumper; from 1 to 3; insulated; red</p>	<p>www.wago.com/2002-423/000-005</p>
	<p>Item no.: 2002-435 Jumper; from 1 to 5; insulated; light gray</p>	<p>www.wago.com/2002-435</p>
	<p>Item no.: 2002-436 Jumper; from 1 to 6; insulated; light gray</p>	<p>www.wago.com/2002-436</p>
	<p>Item no.: 2002-437 Jumper; from 1 to 7; insulated; light gray</p>	<p>www.wago.com/2002-437</p>
	<p>Item no.: 2002-438 Jumper; from 1 to 8; insulated; light gray</p>	<p>www.wago.com/2002-438</p>
	<p>Item no.: 2002-439 Jumper; from 1 to 9; insulated; light gray</p>	<p>www.wago.com/2002-439</p>
	<p>Item no.: 2002-440 Jumper; from 1 to 10; insulated; light gray</p>	<p>www.wago.com/2002-440</p>
	<p>Item no.: 2002-472 Staggered jumper; 2-way; insulated; light gray</p>	<p>www.wago.com/2002-472</p>
	<p>Item no.: 2002-473 Staggered jumper; 3-way; insulated; light gray</p>	<p>www.wago.com/2002-473</p>
	<p>Item no.: 2002-475/011-000 Staggered jumper; 3-way; insulated; light gray</p>	<p>www.wago.com/2002-475/011-000</p>
	<p>Item no.: 2002-475 Staggered jumper; 5-way; insulated; light gray</p>	<p>www.wago.com/2002-475</p>
	<p>Item no.: 2002-476 Staggered jumper; 6-way; insulated; light gray</p>	<p>www.wago.com/2002-476</p>
	<p>Item no.: 2002-474 Staggered jumper; 4-way; insulated; light gray</p>	<p>www.wago.com/2002-474</p>

Subject to changes. Please also observe the further product documentation!

	Item no.: 2002-477 Staggered jumper; 7-way; insulated; light gray	www.wago.com/2002-477
	Item no.: 2002-473/011-000 Staggered jumper; 2-way; from 1 to 3; insulated; light gray	www.wago.com/2002-473/011-000
	Item no.: 2002-479 Staggered jumper; 9-way; insulated; light gray	www.wago.com/2002-479
	Item no.: 2002-478 Staggered jumper; 8-way; insulated; light gray	www.wago.com/2002-478
	Item no.: 2002-479/011-000 Staggered jumper; insulated; light gray	www.wago.com/2002-479/011-000
	Item no.: 2002-480 Staggered jumper; 10-way; insulated; light gray	www.wago.com/2002-480
	Item no.: 2002-477/011-000 Staggered jumper; insulated; light gray	www.wago.com/2002-477/011-000
	Item no.: 2002-481/011-000 Staggered jumper; insulated; light gray	www.wago.com/2002-481/011-000
	Item no.: 2002-481 Staggered jumper; 11-way; insulated; light gray	www.wago.com/2002-481
	Item no.: 2002-482 Staggered jumper; 12-way; insulated; light gray	www.wago.com/2002-482
	Item no.: 210-103 Wire commoning chain; insulated; black	www.wago.com/210-103
	Item no.: 2002-424/000-006 Continuous jumper; from 1 to 4; insulated; blue	www.wago.com/2002-424/000-006
Tool		
Operating tool		
	Item no.: 210-658 Operating tool; Blade: 3.5 x 0.5 mm; with a partially insulated shaft; angled; short; multicoloured	www.wago.com/210-658

Subject to changes. Please also observe the further product documentation!



Item no.: 210-720

Operating tool; Blade: 3.5 x 0.5 mm; with a partially insulated shaft; multicoloured

www.wago.com/210-720

Protective warning marker

Cover



Item no.: 2002-115

Protective warning marker; for 5 terminal blocks; with high-voltage symbol, black; yellow

www.wago.com/2002-115

Mounting

Cover carrier



Item no.: 709-169

Cover carrier; Type 3; gray

www.wago.com/709-169

Cover



Item no.: 709-156

Cover; Type 3; suitable for cover carrier, type 3; 1 m long; transparent

www.wago.com/709-156

Testing and measuring

Testing accessories



Item no.: 2009-174

Test plug adapter; for 4 mm Ø test plugs; for testing TOPJOB®S rail-mounted terminal blocks; gray

www.wago.com/2009-174



Item no.: 2009-182

Testing tap; for max. 2.5 mm²; tool-free connection for individual test wires 0.08 - 2.5 mm; gray

www.wago.com/2009-182



Item no.: 2002-611

TOPJOB®S L-type test plug module; modular; 1-pole; 2,50 mm²; gray

www.wago.com/2002-611



Item no.: 2002-649

TOPJOB®S L-type spacer module; modular; e.g., for bridging commoned terminal blocks; gray

www.wago.com/2002-649

Push-in type wire jumper

Jumper



Item no.: 2009-412

Push-in type wire jumper; insulated; 60 mm long; black

www.wago.com/2009-412



Item no.: 2009-414

Push-in type wire jumper; 1.5 mm²; insulated; 110 mm long; black

www.wago.com/2009-414



Item no.: 2009-416

Push-in type wire jumper; 1.5 mm²; insulated; 250 mm long; black

www.wago.com/2009-416



Subject to changes. Please also observe the further product documentation!

WAGO GmbH & Co. KG

Hansastr. 27

32423 Minden

Phone: +49571 887-0 | Fax: +49571 887-169

Email: info.de@wago.com | Web: www.wago.com

Do you have any questions about our products?

We are always happy to take your call at +49 (571) 887-44222.

Item no.: 2009-414/000-005

Push-in type wire jumper; 1.5 mm²; insulated; 110 mm long; black

www.wago.com/2009-414/000-005



Item no.: 2009-414/000-006

Push-in type wire jumper; insulated; 110 mm long; black

www.wago.com/2009-414/000-006

Downloads

Documentation

Bid Text

2002-2708 docx - Datei	2019 Apr 18	docx 15.6 kB	Download
---------------------------	-------------	-----------------	----------

2002-2708 X81 - Datei	2019 Apr 18	xml 4.3 kB	Download
--------------------------	-------------	---------------	----------

Additional Information

Technical Section Technical explanations		pdf 2.2 MB	Download
---	--	---------------	----------

CAD/CAE-Data

CAD data

2D/3D Models 2002-2708		URL	Download
------------------------	--	-----	----------

CAE data

EPLAN Data Portal 2002-2708		URL	Download
-----------------------------	--	-----	----------

ZUKEN Portal 2002-2708		URL	Download
------------------------	--	-----	----------

Environmental Product Compliance

Compliance Search

Environmental Product Compliance 2002-2708		URL	Download
--	--	-----	----------

Subject to changes. Please also observe the further product documentation!



Double-deck terminal block; 4-conductor through terminal block; L; without marker carrier; suitable for Ex e II applications; internal commoning; conductor entry with violet marking; for DIN-rail 35 x 15 and 35 x 7.5; 2.5 mm²; Push-in CAGE CLAMP®; 2,50 mm²; gray

Installation Notes

Product family

TOPJOB® S

TOPJOB® S: In various industrial applications and modern building installations, WAGO's wide and versatile range of rail-mount terminal blocks provides more than just reliable electrical connections.

[Show all products from the family](#)

Subject to changes. Please also observe the further product documentation!