

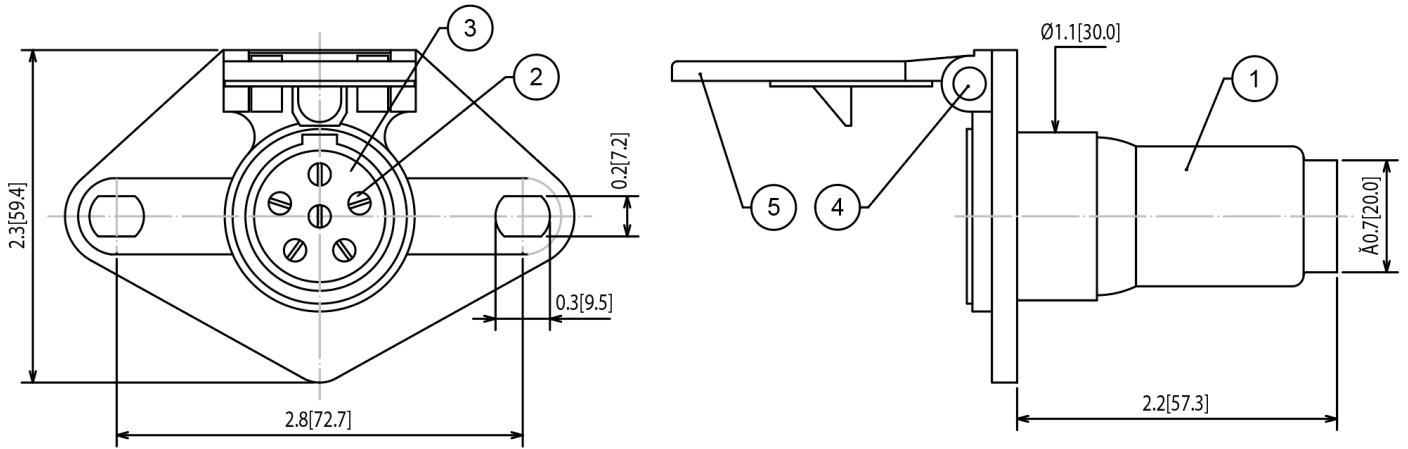







**Mechanical Dimensions: Inches [mm]**

Tolerances  $\pm 0.012$  [0.3] Unless Otherwise Specified



**TOLERANCES:**  
 1mm~5mm:±0.1  
 6mm~20mm:±0.2  
 21mm~50mm:±0.3  
 51mm~100mm:±0.5  
 ANGLES:±1°

**Wiring Color Codes**

A.T.A & S.A.E WIRING CODES RECOMMENDED STANDARD		
CIRCUITS	POLE WIRING COLOR CODE	RECOMMENDED WIRE GAUGE
Ground Return	White 	10 GA
Electric Brake	Blue 	12 GA
Tail, License and Running Lights	Green 	14 GA
Battery Charge	Black 	10 GA
Stop & Left Hand Turn Signal	Red 	14 GA
Stop & Right Hand Turn Signal	Brown 	14 GA
Auxiliary Circuit	Yellow 	14 GA

**Material Specifications**

ITEM#	NAME	MATERIAL
1	PLUG SHELL	IRON
2	SCREW	IRON
3	7-WAY TERMINAL	BRASS
4	WIRE BOOT	PVC
5	HOUSING SCREW	BRASS

Rev	Date of issue	Revision Notes	Designed	Approved
A	07-16-2019	Initial Drawing	RC	OH