

Mechanical Dimensions (mm)

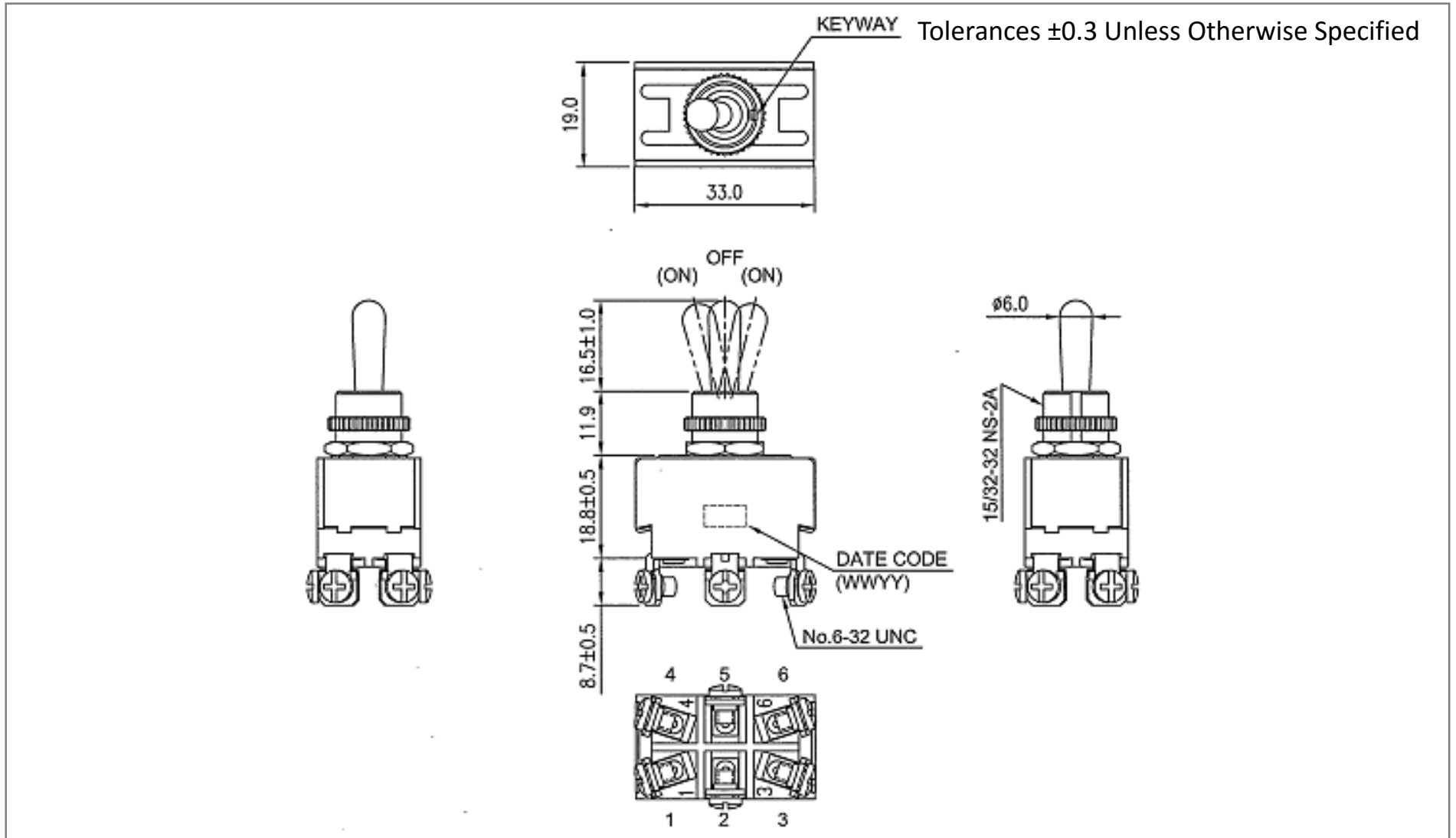

Mounting Hole

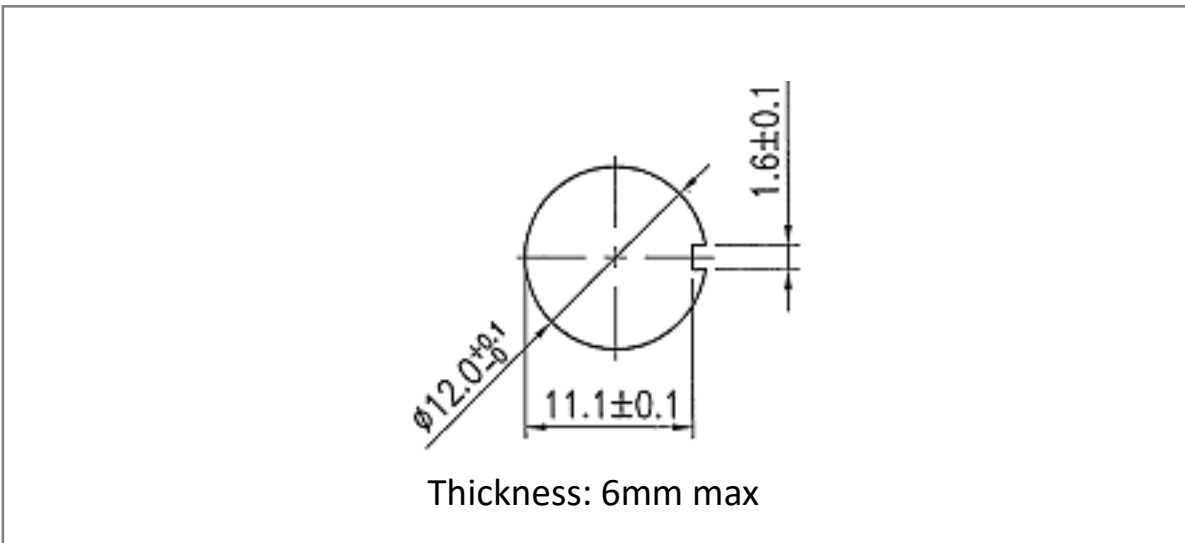

Circuit Diagram

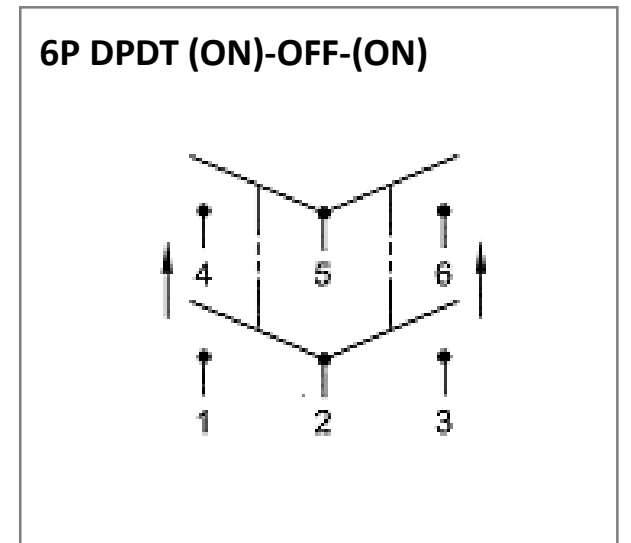

Electrical Specifications

Rating	21A 14V DC
Contact Resistance	50m ohm Max.
Insulation Resistance	DC 500V 100M ohm Min.
Dielectric Strength	AC 1500V 1 minute
Operation Force	1800gf±400gf

Material Specifications

1 HEX NUT ASSY
1 KNURL NUT ASSY