

Dear customer

LAPIS Semiconductor Co., Ltd. ("LAPIS Semiconductor"), on the 1<sup>st</sup> day of October, 2020, implemented the incorporation-type company split (shinsetsu-bunkatsu) in which LAPIS established a new company, LAPIS Technology Co., Ltd. ("LAPIS Technology") and LAPIS Technology succeeded LAPIS Semiconductor's LSI business.

Therefore, all references to "LAPIS Semiconductor Co., Ltd.", "LAPIS Semiconductor" and/or "LAPIS" in this document shall be replaced with "LAPIS Technology Co., Ltd."

Furthermore, there are no changes to the documents relating to our products other than the company name, the company trademark, logo, etc.

Thank you for your understanding.

LAPIS Technology Co., Ltd.  
October 1, 2020

# ML62Q1300 Group

16-bit micro controller

## GENERAL DESCRIPTION

ML62Q1300 Group is a high performance CMOS 16-bit microcontroller equipped with an 16-bit CPU nX-U16/100 and integrated with program memory(Flash memory), data memory(RAM), data Flash and rich peripheral functions such as the multiplier/divider, CRC generator, DMA controller, Clock generator, Timer, General Purpose Ports, UART, Synchronous serial port, I<sup>2</sup>C bus interface unit (Master, Slave), Buzzer, Voltage Level Supervisor(VLS), Successive approximation type A/D converter, D/A converter, Analog comparator, Safety function(IEC60730/60335 Class B) and so on.

The CPU nX-U16/100 is capable of efficient instruction execution in 1-instruction 1-clock mode by pipeline architecture parallel processing.

The built-in on-chip debug function enables debugging and programming the software. Also, ISP(In-System Programming) function supports the Flash programming in production line.

The ML62Q1300 Group has six packages (16pin - 32pin) and five kinds of memory sizes(16Kbyte - 64Kbyte).

Table 1 ML62Q1300 Group Product List

Program memory	Data memory (RAM)	Data Flash	16pin SSOP16 WQFN16	20pin TSSOP20	24pin WQFN24	32pin TQFP32 WQFN32
64Kbyte	4Kbyte	2Kbyte	—	—	ML62Q1347	ML62Q1367
48Kbyte			—	—	ML62Q1346	ML62Q1366
32Kbyte			—	—	ML62Q1345	ML62Q1365
32Kbyte	2Kbyte		ML62Q1325	ML62Q1335	—	—
24Kbyte			ML62Q1324	ML62Q1334	—	—
16Kbyte			ML62Q1323	ML62Q1333	—	—

## FEATURES

- CPU
  - 16-bit RISC CPU: nX-U16/100(A35 core)
  - Instruction system: 16-bit length instructions
  - Instruction set: Transfer, arithmetic operations, comparison, logic operations, multiplication/division, bit manipulations, bit logic operations, jump, conditional jump, call return stack manipulations, arithmetic shift, and so on
  - Built-in On-chip debug function
  - Built-in ISP (In-System Programming) function
  - Minimum instruction execution time  
Approximately 30.5 μs (at 32.768 kHz system clock)  
Approximately 62.5ns/41.6ns (at 16 MHz/24MHz system clock)
- Coprocessor for multiplication and division
  - Multiplication : 16bit × 16bit (operation time : 4 cycles)
  - Division : 32bit ÷ 16bit (operation time : 8 cycles)
  - Division : 32bit ÷ 32bit (operation time : 16 cycles)
  - Multiply-accumulate (non-saturating): 16bit × 16bit + 32bit (operation time : 4 cycles)
  - Multiply-accumulate (saturating): 16bit × 16bit + 32bit (operation time : 4 cycles)
  - Signed or Unsigned is selectable

- Operating voltage and temperature
  - Operating voltage:  $V_{DD} = 1.6$  to  $5.5$  V ( $V_{DD}$  should be  $1.8$ V or over at Power-on)
  - Operating temperature:  $-40$  °C to  $+105$  °C
  
- Internal memory
  - Program memory area
    - Rewrite count: 100 cycles
    - Write unit: 32bit(4byte)
    - Erase unit: 16Kbyte/1Kbyte
    - Erase/Write temperature:  $0$  °C to  $+40$  °C
  
  - Data Flash memory area
    - Rewrite count 10,000 cycles
    - Write unit: 8bit(1byte)
    - Erase unit: all area/128byte
    - Erase/Write temperature:  $-40$  °C to  $+85$  °C
    - Back Ground Operation(CPU can work while erasing and rewriting)

This product uses SuperFlash® technology licensed from Silicon Storage Technology, Inc. SuperFlash® is a registered trademark of Silicon Storage Technology, Inc.

  - Data RAM area
    - Rewrite unit: 8bit/16bit(1byte/2byte)
    - Parity check function is available (interrupt / reset are generatable at Parity error)
  
- Clock
  - Low-speed clock (LSCLK)
    - Internal low-speed RC oscillation: Approximately 32.768 kHz
  - High-speed clock (HSCLK)
    - PLL oscillation: 2 selectable oscillation frequency (24MHz and 16MHz) by code option
  - Watch Dog Timer (WDT): built-in independent clock for WDT (RC1K: Approximately 1kHz )
  
- Reset
  - Reset by reset input pin
  - Reset by Power-On Reset
  - Reset by WDT overflow
  - Reset by WDT invalid clear
  - Reset by RAM parity error
  - Reset by unused ROM area access (instruction access)
  - Reset by voltage level supervisor (VLS)
  - Software reset by BRK instruction (reset CPU only)
  - Reset the peripherals individually
  - Collective reset to the all control pins and peripheral circuits

- Power management
  - HALT mode: CPU stops executing instruction, peripheral circuits continue working
  - HALT-H mode: CPU stops executing instruction, high-speed clock oscillation stops and peripheral circuits continue working with low-speed clock
  - STOP mode: CPU and peripheral circuits stops executing instruction, both high-speed oscillation and low-speed oscillation stop.
  - STOP-D mode: CPU and peripheral circuits stops executing instruction, both high-speed oscillation and low-speed oscillation stop. The internal logic voltage ( $V_{DDL}$ ) goes down to reduce the current consumption (RAM data is retained).
  - Clock gear: High-speed system clock frequency can be changed (1/1, 1/2, 1/4, 1/8, 1/16 or 1/32 of HSCLK)
  - Block Control Function: Powers down the unused function blocks (reset the block or stop supplying the clock)
- Interrupt controller
  - External interrupt ports : max. 8
  - Non-maskable interrupt source: 1 (Internal sources: WDT)
  - Maskable interrupt sources: max.32
  - Four step interrupt levels
- Watchdog timer(WDT)
  - Selectable Operating clock : select RC1K or LSCLK by code option
  - Overflow period: 8selectable (7.8ms, 15.6ms, 31.3ms, 62.5ms, 125ms, 500ms, 2s and 8s)
  - Selectable window function (enable or disable): configurable clear enable period (50% or 75% of overflow period)
  - Selectable WDT operation : select Enable or Disable by code option
  - Readable WDT counter : WDT counter monitor function
- DMA(Direct Memory Access) controller
  - Channel: 2channel
  - Transfer unit: 8bit/16bit
  - Transfer count: 1 to 1024
  - Transfer cycle: 2 cycle transfer
  - Transfer address: Fixed addressing mode, increment addressing mode , and decrement addressing mode
  - Transfer target: Special Function Register (SFR)/RAM → SFR/RAM (Transfer from/to Flash is not supported)
  - Transfer request: External pins, Serial communication unit, Successive approximation type A/D converter, 16bit timer, and Functional timer
- Low-speed Time base counter
  - Generate 8 frequency (128Hz to 1Hz) internal pulse signals by dividing the Low-speed clock (LSCLK)
  - Selectable 3 interrupts from eight frequency internal pulse signals
  - 1Hz or 2Hz output from general purpose port
- Functional timer
  - Channel: 4 channel
  - Built-in timer, capture, and PWM function by 16 bit counter
  - Built-in Repeat mode, One shot mode is available
  - Two types of PWM output with the same period and different duties, and complementary PWM output with the dead time
  - Monitor input signal duty and the period by capture function
  - Generate periodical interrupts, duty interrupts, and interrupts coincided with set value
  - Counter Start, Stop, Counter clear triggered by an external inputs or Timer
  - Generate Emergency stop and emergency stop interrupt triggered by an external input
  - Same start/stop among different channels of the functional timer
  - Selectable counter clock(external clock or divided by 1 to 128 of LSCLK or HSCLK) for each channels

- 16-bit General timers
  - Channel: Max. 6channel
  - 8 bits timer mode and 16-bit timer mode
  - Same start/stop among different channels of 16bit (8bit) timer
  - Timer output (toggled by overflow)
  - Selectable counter clock (external clock or divided by 1 to 128 of LSCLK or HSCLK) for each channels
- Serial communication unit
  - Synchronous Serial Port (SSIO) mode or UART mode is selectable
  - Channel: 2channel
    - < Synchronous Serial Port >
    - Selectable from Master and Slave
    - Selectable from LSB first or MSB first
    - Selectable 8-bit length or 16-bit length
    - < UART mode>
    - Full-duplex communication mode and half-duplex communication mode
    - 5 to 8 bit length, parity or no parity, odd parity or even parity, 1 stop bit or 2 stop bits
    - Selectable from Positive logic or Negative logic
    - Selectable from LSB first or MSB first
    - Configurable wide range communication speed
      - 32.768kHz operation clock : 1bit/s to 4,800 bit/s
      - 24MHz operation clock : 600bit/s to 3M bit/s
      - 16MHz operation clock : 300bit/s to 2M bit/s
    - Built-in baud rate generator
- I<sup>2</sup>C bus unit (Master / Slave)
  - Selectable from Master mode or Slave mode
  - Channel: 1 channel
    - < Master function >
    - Standard mode (100 kbit/s), fast mode (400 kbit/s) and 1Mbps mode(1Mbit/s)
    - Handshake (Clock synchronization)
    - 7bit address format (10bit address format is supported)
    - < Slave function >
    - Standard mode (100 kbit/s), fast mode (400 kbit/s) and 1Mbps mode(1Mbit/s)
    - Clock stretch function
    - 7bit address format
- I<sup>2</sup>C bus Master
  - Channel: 1channel
  - Standard mode (100 kbit/s), fast mode (400 kbit/s) and 1Mbps mode(1Mbit/s)
  - Handshake (Clock synchronization)
  - 7bit address format (10bit address format is supported)
- General-purpose ports (GPIO)
  - I/O port: Max. 28 (Including one pin for on-chip debug and pins for other shared functions)
  - External interrupt port: 8
  - LED driver port : Max. 27
  - Carrier frequency output function (used for IR communication)

- Successive approximation type A/D converter (SA-ADC)
  - Channel: Max.8channel
  - Resolution: 10bit
  - Conversion time: Min. 2.25 $\mu$ s /channel (When the conversion clock speed is 8MHz)
  - Reference voltages are selectable  
(V<sub>DD</sub> pin / Internal reference voltage(V<sub>REFI</sub> = Approximately 1.55V) / External reference voltage (V<sub>REF</sub> pin))
  - Selected channel repeat conversion
  - Dedicated result register for each channel
  - Interrupt determining by upper limit or lower limit threshold of conversion result
- Voltage level supervisor (VLS)
  - Accuracy:  $\pm 4\%$
  - Threshold voltage: 12 selectable (from 1.85V to 4.00V)
  - Functional Voltage level detection reset (VLS reset)
  - Functional Voltage level detection interrupt (VLS0 interrupt)
- Analog comparator
  - Channel: 1channel
  - Selectable interrupt from the comparator output (rising edge or falling edge)
  - Selectable from sampling or without sampling
  - Comparable with external 2 inputs
  - Comparable with external input and internal reference voltage (0.8V)
- D/A converter
  - Channel: Max 1channel
  - Resolution: 8bit
  - Output impedance: 6k ohm(Typ.)
  - R-2R ladder type
- Buzzer
  - 4 buzzer mode (Continuous sound, Single sound, Intermittent sound 1 and Intermittent sound 2)
  - 8 frequencies (4.096kHz to 293Hz)
  - 15 step duty (1/16 to 15/16)
  - Selectable from positive logic buzzer output or negative logic buzzer output
- CRC(Cyclic Redundancy Check) generator
  - Generation equation:  $X^{16}+X^{12}+X^5+1$
  - Selectable from LSB first or MSB first
  - Built-in Automatic program memory CRC calculation mode in HALT mode
- Safety Function(IEC60730/60335 Class B)
  - RAM/SFR guard
  - Automatic program memory CRC calculation
  - RAM parity error detection
  - ROM unused area access reset (instruction access)
  - Clock mutual monitoring
  - WDT counter monitoring
  - SA-ADC test
  - UART test
  - Synchronous serial I/O test
  - I<sup>2</sup>C bus test
  - GPIO test

- Shipping package

- 16-pin plastic SSOP  
ML62Q1323/1324/1325 - xxxMB (Blank part: ML62Q1323/1324/1325-NNNMB)
- 16-pin plastic WQFN  
ML62Q1323/1324/1325 - xxxGD (Blank part: ML62Q1323/1324/1325-NNNGD)
- 20-pin plastic TSSOP  
ML62Q1333/1334/1335 - xxxTD (Blank part: ML62Q1333/1334/1335-NNNTD)
- 24-pin plastic WQFN  
ML62Q1345/1346/1347 - xxxGD (Blank part: ML62Q1345/1346/1347-NNNGD)
- 32-pin plastic TQFP  
ML62Q1365/1366/1367 - xxxTB (Blank part: ML62Q1365/1366/1367-NNNTB)
- 32-pin plastic WQFN  
ML62Q1365/1366/1367 - xxxGD (Blank part: ML62Q1365/1366/1367-NNNGD)

xxx: ROM code number

ML62Q1300 Group how to read the part number

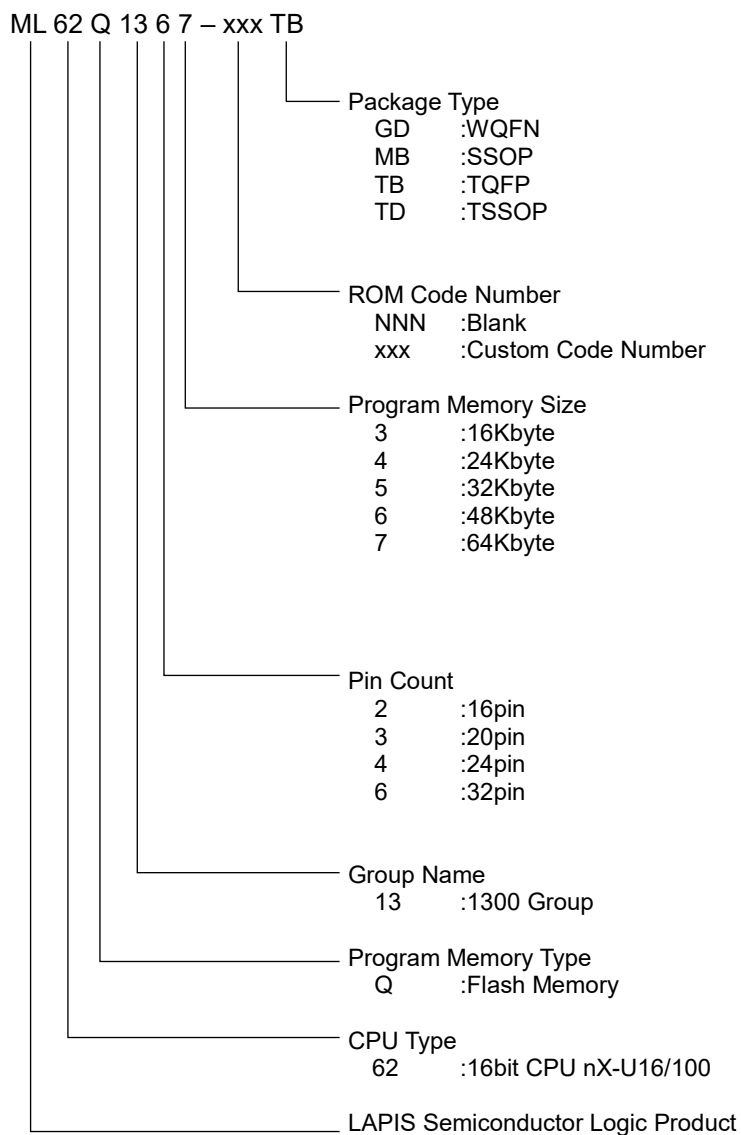

Figure 1 ML62Q1300 Group Part Number



ML62Q1300 Group Main Function List

Table 2 ML62Q1300 Group Main Function List

Part number	Pin				Interrupt		Timer		Serial			Analog				
	Total pin-counts	Power pin counts	Reset Input pin	I/O port	LED drive port	Internal interrupt [source]	External interrupt [port]	Functional Timer [channel]	16-bit Timer [channel] *1	Serial communication unit (Full-duplex UART or Synchronous serial) [channel] *2	I <sup>2</sup> C bus unit (Master/Slave) [channel]	I <sup>2</sup> C bus interface (Master only) [channel]	10bit Successive type A/D converter [channel]	Analog comparator [channel]	Analog comparator [input pin]	8bit D/A converter [channel]
ML62Q1323	16	3	1	12	11	23	8	4	2	1	1	6	1	2	0	0
ML62Q1324				16	15											
ML62Q1325				16	15											
ML62Q1333	20	3	1	16	15	25	8	4	2	1	1	8	1	2	1	1
ML62Q1334				20	19											
ML62Q1335				20	19											
ML62Q1345	24	3	1	20	19	25	8	6	2	1	1	8	1	2	1	1
ML62Q1346				24	27											
ML62Q1347				24	27											
ML62Q1365	32	3	1	28	27	25	8	6	2	1	1	8	1	2	1	1
ML62Q1366				32	27											
ML62Q1367				32	27											

\*1 : One 16-bit timer is configurable as two 8-bit timers.

\*2 : Synchronous Communication unit includes UART and Synchronous Serial Port. UART mode and Synchronous Serial Port can not be used at the same time in the same channel.

BLOCK DIAGRAM

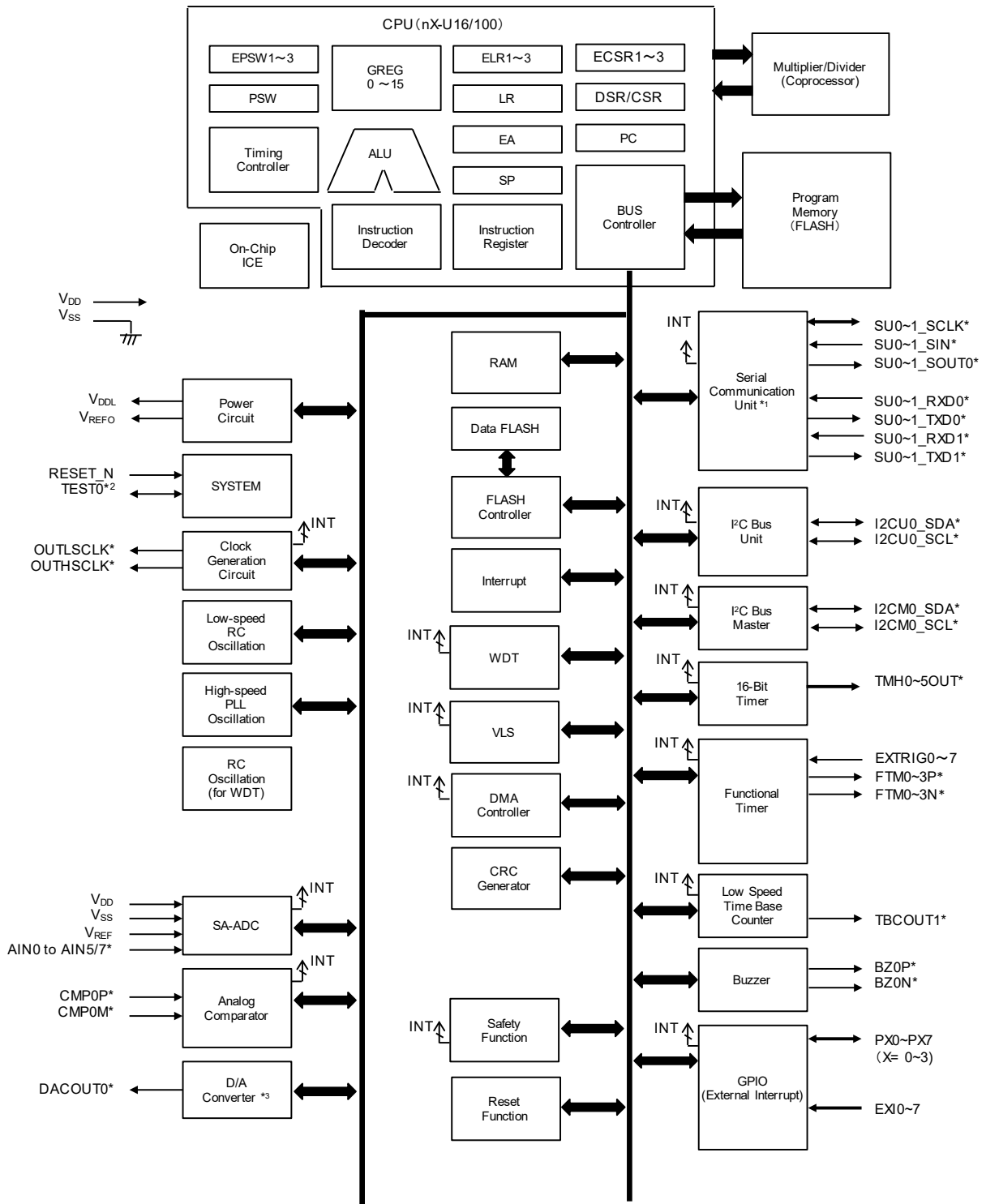

\* : Indicates the shared function of general ports.  
 \*1 : Shared UART and Synchronous Serial Port.  
 \*2 : Not available as the input port when connecting to the on-chip debug emulator.  
 \*3 : ML62Q133x and ML62Q132x does not have the peripheral circuits.

Figure 2 ML62Q1300 Group Block Diagram

## PIN CONFIGURATION

### Pin Layout of ML62Q1323/1324/1325 16pin SSOP Package

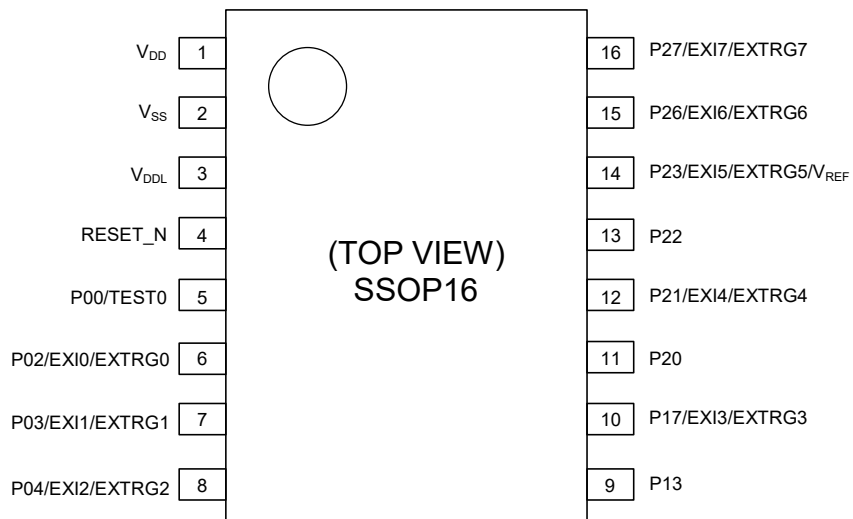

Figure 3 Pin Layout of 16pin SSOP Package

Pin Layout of ML62Q1323/1324/1325 16pin WQFN Package

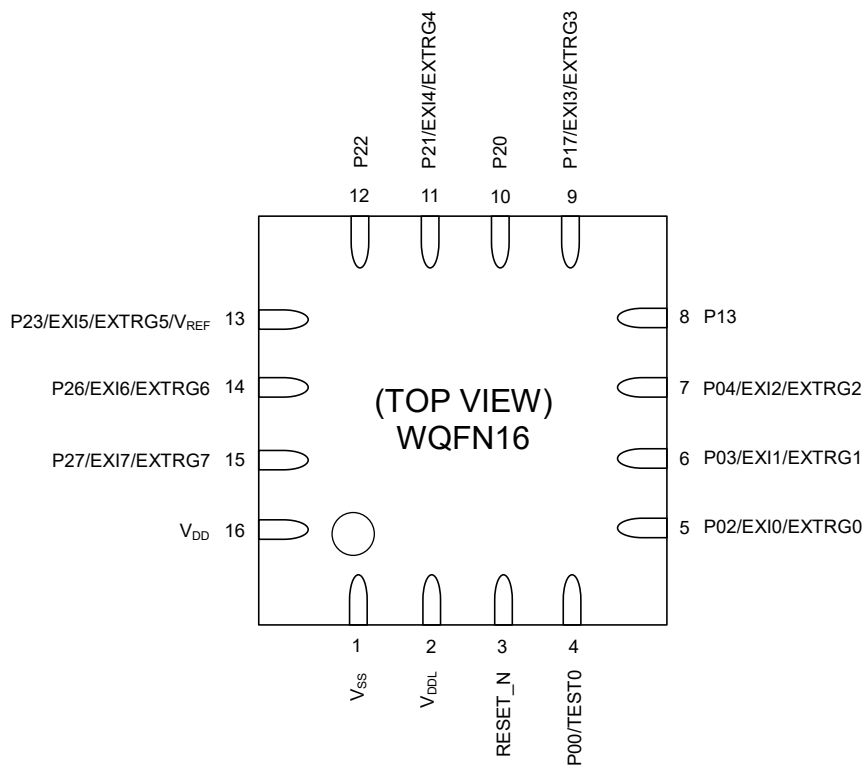

Figure 4 Pin Layout of 16pin WQFN Package

## Pin Layout of ML62Q1333/1334/1335 20pin TSSOP Package

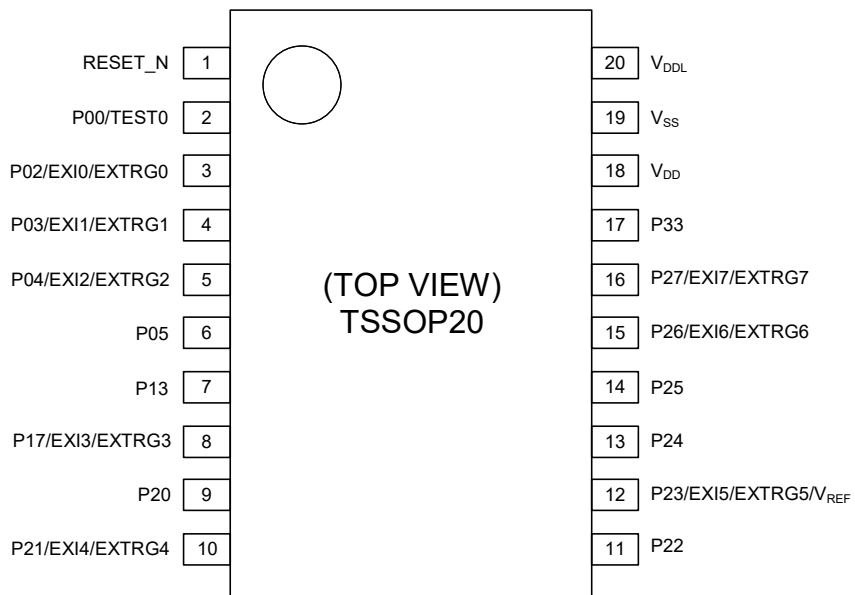

Figure 5 Pin Layout of 20pin TSSOP Package

## Pin Layout of ML62Q1345/1346/1347 24pin WQFN Package

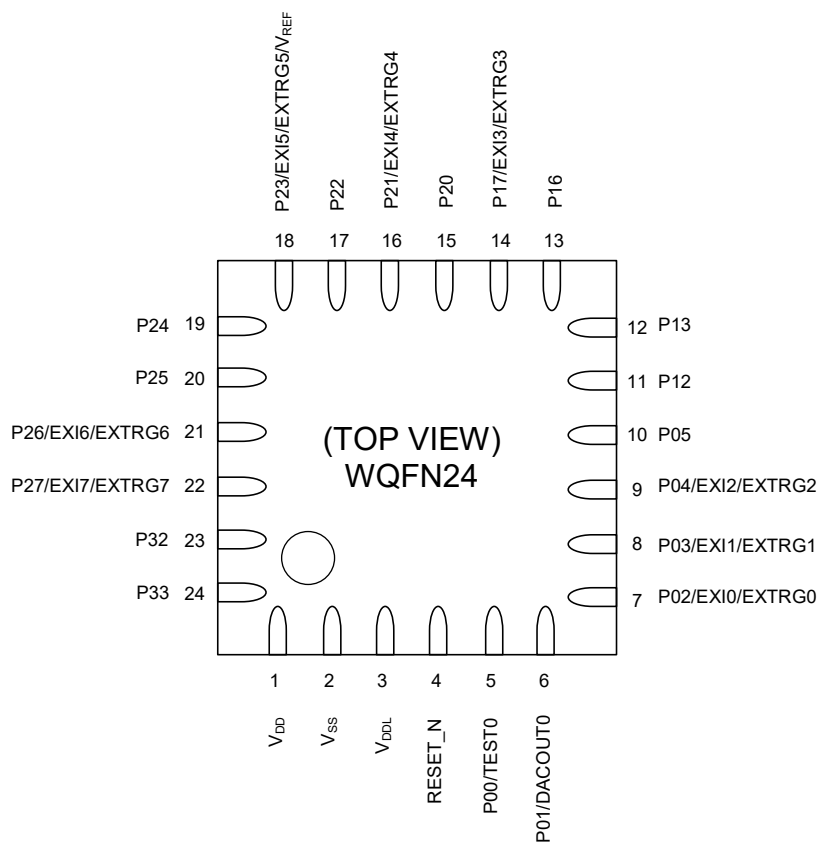

Figure 6 Pin Layout of 24pin WQFN Package

## Pin Layout of ML62Q1365/1366/1367 32pin TQFP Package

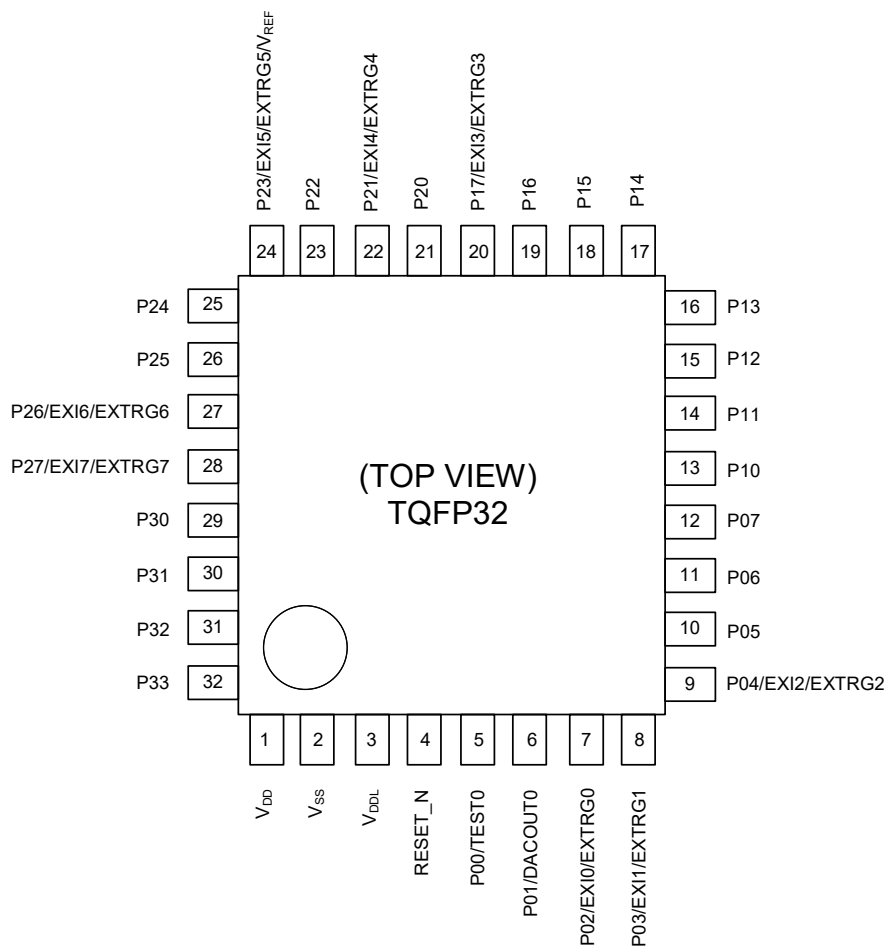

Figure 7 Pin Layout of 32pin TQFP Package

## Pin Layout of ML62Q1365/1366/1367 32pin WQFN Package

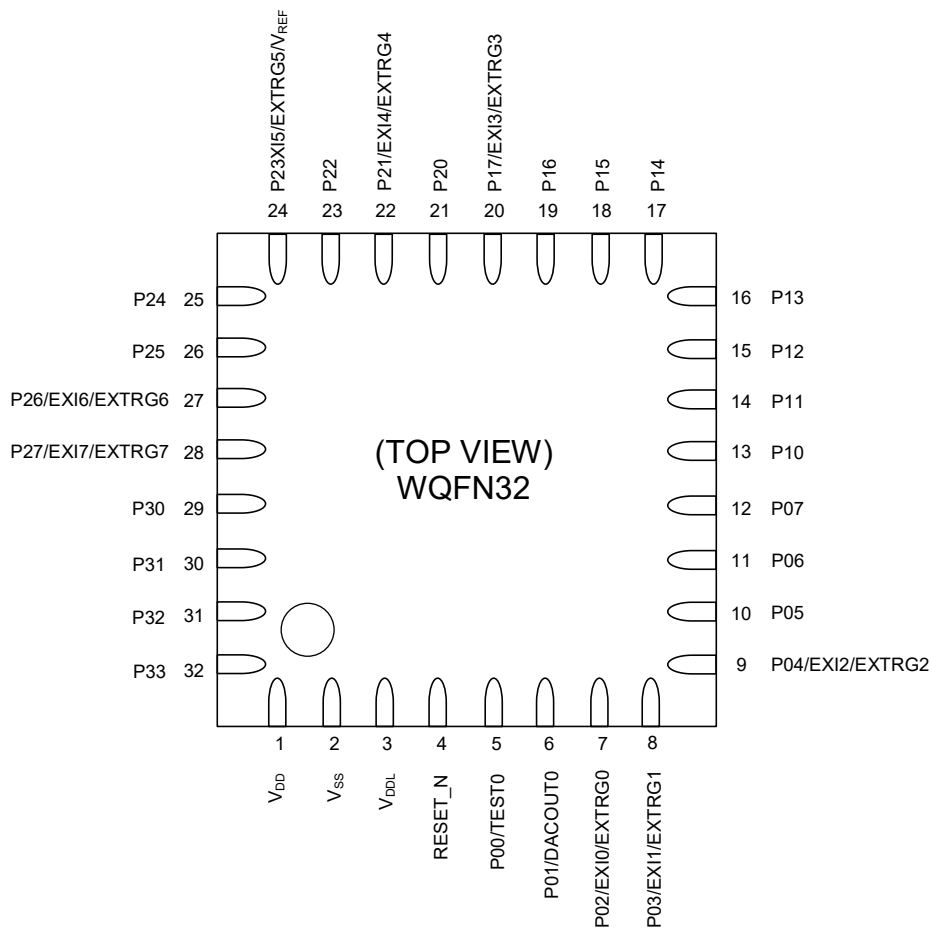

Figure 8 Pin Layout of 32pin WQFN Package



PIN LIST

Table 3 Pin List

Pin No.					Pin name (Primary function)	Primary function Others	2 <sup>nd</sup> function Communications	3 <sup>rd</sup> function Communications	4 <sup>th</sup> function Communications	5 <sup>th</sup> function Timers	6 <sup>th</sup> function Others	7 <sup>th</sup> function Others	8 <sup>th</sup> function ADC
16Pin No.(SSOP)	16Pin No.(WQFN)	20Pin No.(TSSOP)	24Pin No.(WQFN)	32Pin No.(TQFP) (WQFN)									
1	16	18	1	1	V <sub>DD</sub>	-	-	-	-	-	-	-	-
2	1	19	2	2	V <sub>SS</sub>	-	-	-	-	-	-	-	-
3	2	20	3	3	V <sub>DDL</sub>	-	-	-	-	-	-	-	-
4	3	1	4	4	RESET_N	-	-	-	-	-	-	-	-
5	4	2	5	5	P00	TEST0	-	-	-	-	-	-	-
-	-	-	6	6	P01	DACOUT0	-	-	-	-	-	-	-
6	5	3	7	7	P02	EXI0 EXTRG0	SU0_RXD0 SU0_SIN	-	-	FTM0P	OUTLSCLK	CMP0M	-
7	6	4	8	8	P03	EXI1 EXTRG1	SU0_TXD0 SU0_SOUT	SU0_TXD1	I2CU0_SDA	FTM0N	OUTHSCCLK	CMP0P	-
8	7	5	9	9	P04	EXI2 EXTRG2	SU0_SCLK	-	I2CU0_SCL	TMH0OUT	-	-	-
-	-	6	10	10	P05	-	-	-	-	-	-	-	-
-	-	-	-	11	P06	-	-	-	I2CM0_SDA	-	-	-	-
-	-	-	-	12	P07	-	SU0_RXD1	SU0_RXD0	I2CM0_SCL	-	-	-	-
-	-	-	-	13	P10	-	SU0_TXD1	-	-	-	-	-	-
-	-	-	-	14	P11	-	SU0_SCLK	-	-	-	-	-	-
-	-	-	11	15	P12	-	SU0_RXD0 SU0_SIN	-	-	TMH4OUT	-	-	-
9	8	7	12	16	P13	-	SU0_TXD0 SU0_SOUT	SU0_TXD1	-	TMH1OUT	-	TMH3OUT	-
-	-	-	-	17	P14	-	-	-	-	-	-	-	-
-	-	-	-	18	P15	-	-	-	I2CU0_SDA	-	-	-	-
-	-	-	13	19	P16	-	SU1_SCLK	-	I2CU0_SCL	TMH5OUT	-	-	-
10	9	8	14	20	P17	EXI3 EXTRG3	SU0_RXD1	SU0_RXD0	-	FTM1P	-	BZ0P	AIN0
11	10	9	15	21	P20	-	SU0_TXD1	-	-	FTM1N	TBCOUT1	BZ0N	AIN1
12	11	10	16	22	P21	EXI4 EXTRG4	SU1_RXD0 SU1_SIN	-	-	FTM2P	OUTLSCLK	-	AIN2
13	12	11	17	23	P22	-	SU1_TXD0 SU1_SOUT	SU1_TXD1	I2CM0_SDA	FTM2N	OUTHSCCLK	-	AIN3
14	13	12	18	24	P23	EXI5 EXTRG5 V <sub>REF</sub>	SU1_SCLK	-	I2CM0_SCL	TMH2OUT	-	-	V <sub>REF0</sub>
-	-	13	19	25	P24	-	SU1_RXD0 SU1_SIN	-	-	-	-	-	AIN4
-	-	14	20	26	P25	-	SU1_TXD0 SU1_SOUT	SU1_TXD1	-	-	-	-	AIN5
15	14	15	21	27	P26	EXI6 EXTRG6	SU1_RXD1	SU1_RXD0	I2CU0_SDA	FTM3P	-	BZ0P	AIN6
16	15	16	22	28	P27	EXI7 EXTRG7	SU1_TXD1	-	I2CU0_SCL	FTM3N	TBCOUT1	BZ0N	AIN7
-	-	-	-	29	P30	-	-	-	-	-	-	-	-
-	-	-	-	30	P31	-	-	-	-	-	-	-	-
-	-	-	23	31	P32	-	SU1_RXD1	SU1_RXD0	-	-	-	-	-
-	-	17	24	32	P33	-	SU1_TXD1	-	-	TMH3OUT	-	-	-

## PIN DESCRIPTION

Table 4 Pin Description (1/4)

Function	Signal name	Pin name	I/O	Description	Logic
Power	—	V <sub>SS</sub>	—	Negative power supply pin (-)	—
	—	V <sub>DD</sub>	—	Positive power supply pin (+). Connect a capacitor C <sub>V</sub> between this pin and V <sub>SS</sub> .	—
	—	V <sub>DDL</sub>	—	Power supply pin for internal logic (internal regulator's output). Connect a capacitor C <sub>L</sub> (1μF) between this pin and V <sub>SS</sub> .	—
Test	TEST0	P00	I/O	Input for testing, is used as on-chip debug interface and ISP function. P00 is initialized as pull-up input mode by the system reset.	—
System	V <sub>REF0</sub>	P23	—	Reference voltage output	—
	RESET_N	RESET_N	I	Reset input. Applying "L" level shifts the MCU in system reset mode. Applying "H" level shifts the CPU in program running mode. Used for on-chip debug interface and ISP function. No pull-up resistor is installed.	Negative
	OUTLSCLK	P02 P21	O	Low-speed clock output.	—
	OUTHCLK	P03 P22	O	High-speed clock output.	—
General port (GPIO)	P00	P00	I/O	General purpose I/O port - High-impedance - Input with Pull-UP (initial value) - Input without Pull-UP - CMOS output - N-channel open drain output Not available to use as I/O pin when using for on-chip debug interface or ISP function.	Positive
	P01 – P07	P01 – P07	I/O	General purpose I/O - High-impedance (initial value) - Input with Pull-UP - Input without Pull-UP - CMOS output - N-channel open drain output	Positive
	P10 – P17	P10 – P17			
	P20 – P27	P20 – P27			
	P30 – P33	P30 – P33			

Table 4 Pin Description (2/4)

Function	Signal name	Pin name	I/O	Description	Logic
UART	SU0_TXD0	P03	O	Serial communication unit0 UART0 data output	Positive
		P13			
	SU0_RXD0	P02	I	Serial communication unit0 Full-duplex data input Serial communication unit0 UART0 data input	Positive
		P07			
		P12			
		P17			
	SU0_TXD1	P03	O	Serial communication unit0 Full-duplex data output Serial communication unit0 UART1 data output	Positive
		P10			
		P13			
		P20			
	SU0_RXD1	P07 P17	I	Serial communication unit0 UART1 data input	Positive
	SU1_TXD0	P22 P25	O	Serial communication unit1 UART0 data output	Positive
SU1_RXD0	P21	I	Serial communication unit1 Full-duplex data input Serial communication unit1 UART0 data input	Positive	
	P24				
	P26				
	P32				
SU1_TXD1	P22	O	Serial communication unit1 Full-duplex data output Serial communication unit1 UART1 data output	Positive	
	P25				
	P27				
	P33				
SU1_RXD1	P26 P32	I	Serial communication unit1 UART1 data input	Positive	
Synchronous Serial Port	SU0_SIN	P02	I	Serial communication unit0 Synchronous serial data input	Positive
		P12			
	SU0_SCLK	P04	I/O	Serial communication unit0 Synchronous serial clock I/O	Positive
		P11			
	SU0_SOUT	P03	O	Serial communication unit0 Synchronous serial data output	Positive
		P13			
SU1_SIN	P21	I	Serial communication unit1 Synchronous serial data input	Positive	
	P24				
SU1_SCLK	P16	I/O	Serial communication unit1 Synchronous serial clock I/O	Positive	
	P23				
SU1_SOUT	P22 P25	O	Serial communication unit1 Synchronous serial data output	Positive	
I <sup>2</sup> C Bus	I2CU0_SDA	P03	I/O	I <sup>2</sup> C Unit0 (Master and Salve) Data I/O N-channel open drain Connect a pull-up resistor externally	Positive
		P15			
		P26			
	I2CU0_SCL	P04	I/O	I <sup>2</sup> C Unit0 (Master and Salve) Clock I/O N-channel open drain output Connect a pull-up resistor externally	Positive
		P16			
		P27			
	I2CM0_SDA	P06	I/O	I <sup>2</sup> C Master0 Data I/O pin N-channel open drain output Connect a pull-up resistor externally	Positive
		P22			
I2CM0_SCL	P07	I/O	I <sup>2</sup> C Master0 Clock I/O N-channel open drain output Connect a pull-up resistor externally	Positive	
	P23				

Table 4 Pin Description (3/4)

Function	Signal name	Pin name	I/O	Description	Logic
Functional Timer (FTM)	FTM0P	P02	O	Functional Timer0 P output.	Positive
	FTM0N	P03	O	Functional Timer0 N output.	Negative
	FTM1P	P17	O	Functional Timer1 P output.	Positive
	FTM1N	P20	O	Functional Timer1 N output.	Negative
	FTM2P	P21	O	Functional Timer2 P output.	Positive
	FTM2N	P22	O	Functional Timer2 N output.	Negative
	FTM3P	P26	O	Functional Timer3 P output.	Positive
	FTM3N	P27	O	Functional Timer3 N output.	Negative
	EXTRG0	P02	I	Functional Timer event trigger input	—
	EXTRG1	P03	I	Functional Timer event trigger input	—
	EXTRG2	P04	I	Functional Timer event trigger input	—
	EXTRG3	P17	I	Functional Timer event trigger input	—
	EXTRG4	P21	I	Functional Timer event trigger input	—
	EXTRG5	P23	I	Functional Timer event trigger input	—
EXTRG6	P26	I	Functional Timer event trigger input	—	
EXTRG7	P27	I	Functional Timer event trigger input	—	
16bit General Timer	TMH0OUT	P04	O	16bit General Timer 0 output	Positive
	TMH1OUT	P13	O	16bit General Timer 1 output	Positive
	TMH2OUT	P23	O	16bit General Timer 2 output	Positive
	TMH3OUT	P13 P33	O	16bit General Timer 3 output	Positive
	TMH4OUT	P12	O	16bit General Timer 4 output	Positive
	TMH5OUT	P16	O	16bit General Timer 5 output	Positive
	EXTRG0	P02	I	16bit General Timer trigger input	—
EXTRG1	P03	I	16bit General Timer trigger input	—	
Low-Speed Time Base Counter (LTBC)	TBCOUT1	P20 P27	O	Low-speed Time Base Counter 1Hz/2Hz output	Positive
Buzzer	BZ0P	P17 P26	O	Buzzer output (positive phase)	Positive
	BZ0N	P20 P27	O	Buzzer output (negative phase)	Negative

Table 4 Pin Description (4/4)

Function	Signal name	Pin name	I/O	Description	Logic
External Interrupt	EXI0	P02	I	External interrupt 0 input	—
	EXI1	P03	I	External interrupt 1 input	—
	EXI2	P04	I	External interrupt 2 input	—
	EXI3	P17	I	External interrupt 3 input	—
	EXI4	P21	I	External interrupt 4 input	—
	EXI5	P23	I	External interrupt 5 input	—
	EXI6	P26	I	External interrupt 6 input	—
Successive approximation type A/D converter	V <sub>REF</sub>	P23	—	SA-ADC external reference voltage input	—
	AIN0	P17	I	SA-ADC channel 0 input	—
	AIN1	P20	I	SA-ADC channel 1 input	—
	AIN2	P21	I	SA-ADC channel 2 input	—
	AIN3	P22	I	SA-ADC channel 3 input	—
	AIN4	P24	I	SA-ADC channel 4 input	—
	AIN5	P25	I	SA-ADC channel 5 input	—
	AIN6	P26	I	SA-ADC channel 6 input	—
Analog comparator	CMP0P	P03	I	Comparator input 0 (noninverting input)	—
	CMP0M	P02	I	Comparator input 0 (inverting input)	—
D/A converter	DACOUT0	P01	O	D/A converter0 output	—

## TERMINATION OF UNUSED PINS

Table 5 Termination of unused pins

Pin	pin termination
RESET_N	Connect to $V_{DD}$
P00/TEST0	Connect to $V_{DD}$ with initial state (pulled-up input mode)
P01 to P07	Open with initial state(Hi-impedance)
P10 to P17	
P20 to P27	
P30 to P33	

## Note:

- Terminate unused input pins according to the table 5 in order to avoid unexpected through-current in the pins.

## ELECTRICAL CHARACTERISTICS

## Absolute Maximum Ratings

(V<sub>SS</sub> = 0V)

Parameter	Symbol	Condition	Rating	Unit	
Power supply voltage 1	V <sub>DD</sub>	Ta = +25°C	-0.3 to +6.5	V	
Power supply voltage 2	V <sub>DDL</sub>	Ta = +25°C	-0.3 to +2.0	V	
Input voltage	V <sub>IN</sub>	Ta = +25°C	-0.3 to V <sub>DD</sub> +0.3* <sup>1</sup>	V	
Output voltage	V <sub>OUT</sub>	Ta = +25°C	-0.3 to V <sub>DD</sub> +0.3* <sup>1</sup>	V	
“H” level output current	I <sub>OUTH</sub>	Ta = +25°C	1pin	-40* <sup>2</sup>	mA
			Total	-150* <sup>2</sup>	
“L” level output current	I <sub>OUTL</sub>	Ta = +25°C	1pin	+40	mA
			Total	+150	
Power dissipation	PD	Ta = +25°C	1	W	
Storage temperature	T <sub>STG</sub>	—	-55 to +150	°C	

\*<sup>1</sup> 6.5V or lower\*<sup>2</sup> The current flowing out the LSI through the pin is described in the negative number.

The applicable maximum current is the absolute value.

For example, -1mA means the maximum current 1mA flows out the LSI through the pin.

[Note]

Stresses above the absolute maximum ratings listed in the above table may cause permanent damage to the device.

These are stress ratings only and functional operation of the device at these conditions is not implied.

## Recommended Operating Conditions

(V<sub>SS</sub> = 0V)

Parameter	Symbol	Condition	Range	Unit
Operating temperature(Ambient)	Ta	—	-40 to +105	°C
Operating temperature(Chip-Junction)	T <sub>j</sub>	—	-40 to +115	°C
Operating voltage	V <sub>DD</sub>	—	1.6 to 5.5	V
Operating frequency (CPU)	f <sub>OP</sub>	V <sub>DD</sub> = 1.6 to 5.5V	30k to 4M	Hz
		V <sub>DD</sub> = 1.8 to 5.5V	30k to 25M	
V <sub>DDL</sub> pin external capacitance	C <sub>L</sub>	—	1.0 ±30%	μF

## Thermal characteristics

The maximum chip-junction temperature,  $T_{jmax}$ , may be calculated using the following equation.

$$T_{jmax} = T_{amax} + P_{Dmax} \times \theta_{ja}$$

$T_{amax}$  : maximum ambient temperature

$P_{Dmax}$  : LSI maximum power dissipation

$\theta_{ja}$  : Package junction to ambient thermal resistance

Design a Mounting board by considering heat radiation such as power dissipation and ambient temperature to satisfy the recommended conditions.

The following table shows the each package's thermal resistance for thermal design reference estimated by simulation based on the PCB (printed circuit board) conditions define as a below.

Parameter	Symbol	Package type	Value		Unit
			L1	L2	
Thermal resistance	$\theta_{ja}$	SSOP16	90.5	84.3	°C/W
		WQFN16	80.8	74.7	
		TSSOP20	58.2	50.8	
		WQFN24	59.0	51.0	
		WQFN32	50.6	43.5	
		TQFP32	67.6	61.8	

PCB conditions:

PCB name	L1	L2	Unit
PCB size (L / W / T)	114.3 / 76.2 / 1.6	114.3 / 76.2 / 1.6	mm
Number of layer	1	2	layer
Wiring density	60% (top layer)	60%(top and bottom layer)	—
Wind condition	No wind (0m/s)		—

WQFN package's thermal resistance is simulated on the condition that the exposed pad is soldered on the PCB.



## Current Consumption 1

Product: ML62Q1323, ML62Q1324, ML62Q1325, ML62Q1333, ML62Q1334, ML62Q1335

(V<sub>DD</sub>=1.6 to 5.5V, V<sub>SS</sub>=0V, Ta=-40 to +105°C, unless otherwise specified)

Parameter	Symbol	Condition	Min.	Typ. * <sup>3</sup>	Max.	Unit	Measuring circuit
Supply current 0	IDD0	CPU is in STOP-D state. Low-speed RC1K/RC32K and PLL oscillation are stopped.	Ta = -40 to +85 °C	—	0.60	17	μA
			Ta = -40 to +105 °C	—		36	
Supply current 1	IDD1	CPU is in STOP state. Low-speed RC1K/RC32K and PLL oscillation are stopped.	Ta = -40 to +85 °C	—	0.75	20	μA
			Ta = -40 to +105 °C	—		42	
Supply current 2	IDD2	Low-speed RC32K Oscillating. CPU is in HALT state (LTBC and WDT are operating <sup>*1</sup> ). PLL oscillation is stopped.	Ta = -40 to +85 °C	—	3.6	27	μA
			Ta = -40 to +105 °C	—		44	
Supply current 3	IDD3	CPU: Running with 32kHz RC oscillation clock <sup>*1*2</sup> PLL oscillation is stopped.	Ta = -40 to +105 °C	—	17	66	μA
Supply current 4	IDD4	CPU: Running with 16MHz PLL oscillating clock <sup>*1*2</sup> PLL 16MHz is oscillating. V <sub>DD</sub> =1.8~5.5V	Ta = -40 to +105 °C	—	3.1	3.8	mA
Supply current 5	IDD5	CPU: Running with 24MHz PLL oscillating clock <sup>*1*2</sup> PLL 24MHz is oscillating. V <sub>DD</sub> =1.8~5.5V	Ta = -40 to +105 °C	—	4.4	5.3	

1

\*<sup>1</sup> LTBC and WDT is operating, Significant bits of BLKCON0-3 and BRECON0-3 registers are all "1"\*<sup>2</sup> CPU running in wait mode\*<sup>3</sup> On the condition of V<sub>DD</sub>=3.0V, Ta=+25 °C

## Current Consumption 2

Product: ML62Q1345, ML62Q1346, ML62Q1347, ML62Q1365, ML62Q1366, ML62Q1367

 ( $V_{DD}=1.6$  to  $5.5V$ ,  $V_{SS}=0V$ ,  $T_a=-40$  to  $+105^{\circ}C$ , unless otherwise specified)

Parameter	Symbol	Condition	Min.	Typ. * <sup>3</sup>	Max.	Unit	Measuring circuit
Supply current 0	IDD0	CPU is in STOP-D state. Low-speed RC1K/RC32K and PLL oscillation are stopped.	$T_a = -40$ to $+85^{\circ}C$	—	0.80	18	$\mu A$
			$T_a = -40$ to $+105^{\circ}C$	—		40	
Supply current 1	IDD1	CPU is in STOP state. Low-speed RC1K/RC32K and PLL oscillation are stopped.	$T_a = -40$ to $+85^{\circ}C$	—	0.95	21	$\mu A$
			$T_a = -40$ to $+105^{\circ}C$	—		45	
Supply current 2	IDD2	Low-speed RC32K Oscillating. CPU is in HALT state (LTBC and WDT are operating <sup>*1</sup> ). PLL oscillation is stopped.	$T_a = -40$ to $+85^{\circ}C$	—	4.3	33	$\mu A$
			$T_a = -40$ to $+105^{\circ}C$	—		50	
Supply current 3	IDD3	CPU: Running with 32kHz RC oscillation clock <sup>*1*2</sup> PLL oscillation is stopped.	$T_a = -40$ to $+105^{\circ}C$	—	20	70	$\mu A$
Supply current 4	IDD4	CPU: Running with 16MHz PLL oscillating clock <sup>*1*2</sup> PLL 16MHz is oscillating. $V_{DD}=1.8\sim 5.5V$	$T_a = -40$ to $+105^{\circ}C$	—	4.3	4.8	mA
Supply current 5	IDD5	CPU: Running with 24MHz PLL oscillating clock <sup>*1*2</sup> PLL 24MHz is oscillating. $V_{DD}=1.8\sim 5.5V$	$T_a = -40$ to $+105^{\circ}C$	—	6.4	7.0	

1

\*<sup>1</sup> LTBC and WDT is operating, Significant bits of BLKCON0-3 and BRECON0-3 registers are all "1"

\*<sup>2</sup> CPU running in wait mode

\*<sup>3</sup> On the condition of  $V_{DD}=3.0V$ ,  $T_a=+25^{\circ}C$

## On-chip Oscillator

(V<sub>DD</sub>=1.6 to 5.5V, V<sub>SS</sub>=0V, Ta=-40 to +105°C, unless otherwise specified)

Parameter	Symbol	Condition	Min.	Typ.	Max.	Unit	Measuring circuit
Low-speed RC oscillator frequency accuracy 1 Without software adjustment	f <sub>RCL1</sub>	Ta= +25°C V <sub>DD</sub> = 1.8 to 5.5V	Typ. -1.0%	32.768	Typ. +1.0%	kHz	1
		Ta= -40 to +85°C V <sub>DD</sub> = 1.8 to 5.5V	Typ. -2.5%	32.768	Typ. +2.5%		
		Ta= -40 to +105°C V <sub>DD</sub> = 1.8 to 5.5V	Typ. -3.0%	32.768	Typ. +3.0%		
		V <sub>DD</sub> = 1.6 to 1.8V	Typ. -3.5%	32.768	Typ. -3.5%		
Low-speed RC oscillator frequency accuracy 2 With software adjustment	f <sub>RCL2</sub>	Ta= -40 to +85°C V <sub>DD</sub> = 1.8 to 5.5V	Typ. -1.0%	32.768	Typ. +1.0%		
		Ta= -40 to +105°C V <sub>DD</sub> = 1.8 to 5.5V	Typ. -1.5%	32.768	Typ. +1.5%		
PLL oscillation frequency accuracy 1 Without software adjustment	f <sub>PLL1</sub>	Ta= -40 to +85°C V <sub>DD</sub> = 1.8 to 5.5V	Typ. -2.5%	16/24	Typ. +2.5%	MHz	
		Ta= -40 to +105°C V <sub>DD</sub> = 1.8 to 5.5V	Typ. -3.0%	16/24	Typ. +3.0%		
		V <sub>DD</sub> = 1.6 to 1.8V	Typ. -3.5%	16/24	Typ. +3.5%		
PLL oscillation frequency accuracy 2 With software adjustment	f <sub>PLL2</sub>	Ta= -40 to +85°C V <sub>DD</sub> = 1.8 to 5.5V	Typ. -1.0%	16/24	Typ. +1.0%		
		Ta= -40 to +105°C V <sub>DD</sub> = 1.8 to 5.5V	Typ. -1.5%	16/24	Typ. +1.5%		
PLL oscillation start time	T <sub>PLL</sub>	V <sub>DD</sub> = 1.6 to 5.5V	—	—	2	ms	
1kHz Low-speed RC oscillator (for WDT) frequency accuracy	f <sub>RC1K</sub>	Ta= -40 to +105°C V <sub>DD</sub> = 1.6 to 5.5V	0.5	1	2.5	kHz	

## Input / Output pin 1

(V<sub>DD</sub>=1.6 to 5.5V, V<sub>SS</sub>=0V, Ta=-40 to +105°C, unless otherwise specified)

Parameter	Symbol	Condition	Min.	Typ.	Max.	Unit	Measuring circuit
Output voltage1 "H"/"L" level (P00-P07) (P10-P17) (P20-P27) (P30-P33)	VOH1	IOH1=-10mA V <sub>DD</sub> ≥4.5V	V <sub>DD</sub> -1.5	—	—	V	2
		IOH1=-1mA V <sub>DD</sub> ≥1.6V	V <sub>DD</sub> -0.5	—	—		
	VOL1	IOL1=+10mA V <sub>DD</sub> ≥4.5V	—	—	1.5		
		IOL1=+1mA V <sub>DD</sub> ≥1.6V	—	—	0.5		
Output voltage2 "L" level (P01-P07) (P10-P17) (P20-P27) (P30-P33)	VOL2	When Nch open drain output mode is selected	IOL2=+15mA V <sub>DD</sub> ≥4.5V	—	—	0.7	
			IOL2=+8mA V <sub>DD</sub> ≥3.0V	—	—	0.5	
			IOL2=+3mA V <sub>DD</sub> ≥2.0V	—	—	0.4	
			IOL2=+2mA V <sub>DD</sub> ≥1.6V	—	—	0.4	

## Input / Output pin 2

(V<sub>DD</sub>=1.6 to 5.5V, V<sub>SS</sub>=0V, Ta=-40 to +105°C, unless otherwise specified)

Parameter	Symbol	Condition	Min.	Typ.	Max.	Unit	Measuring circuit
“H” level output current <sup>1</sup> * <sup>6</sup>	IOH1	1pin	V <sub>DD</sub> ≥4.5V	-10 <sup>*3*5</sup>	—	—	mA
			V <sub>DD</sub> ≥1.6V	-1 <sup>*3*5</sup>	—	—	
“H” level output current <sup>1</sup> * <sup>1*4</sup>	IOH3	Total of ‘P00-P07 and P10-P13 or Total of ‘P14-P17, P20-P27 and P30-P33 (Duty≤50%)	V <sub>DD</sub> ≥4.5V	-50 <sup>*5</sup>	—	—	
			V <sub>DD</sub> ≥1.6V	-20 <sup>*5</sup>	—	—	
		All pin total (Duty≤50%)	V <sub>DD</sub> ≥4.5V	-100 <sup>*5</sup>	—	—	
			V <sub>DD</sub> ≥1.6V	-40 <sup>*5</sup>	—	—	
“L” level output current <sup>1</sup> * <sup>6</sup>	IOL1	1pin (CMOS output mode)	V <sub>DD</sub> ≥4.5V	—	—	10 <sup>*3</sup>	
			V <sub>DD</sub> ≥1.6V	—	—	1 <sup>*3</sup>	
“L” level output current <sup>2</sup> * <sup>6</sup>	IOL2	1pin (Nch open drain output mode)	V <sub>DD</sub> ≥4.5V	—	—	15 <sup>*3</sup>	
			V <sub>DD</sub> ≥3.0V	—	—	8 <sup>*3</sup>	
			V <sub>DD</sub> ≥2.0V	—	—	3 <sup>*3</sup>	
			V <sub>DD</sub> ≥1.6V	—	—	2 <sup>*3</sup>	
“L” level output total current <sup>2</sup> * <sup>2*4</sup>	IOL3	Total of P00-P07 and P10-P13 or Total of P14-P17, P20-P27 and P30-P33 (Nch open drain output mode, duty≤50%)	V <sub>DD</sub> ≥4.5V	—	—	60	
			V <sub>DD</sub> ≥3.0V	—	—	40	
		All pin total (Nch open drain output mode, duty≤50%)	V <sub>DD</sub> ≥2.0V	—	—	15	
			V <sub>DD</sub> ≥1.6V	—	—	10	
		All pin total (Nch open drain output mode, duty≤50%)	V <sub>DD</sub> ≥4.5V	—	—	120	
			V <sub>DD</sub> ≥1.6V	—	—	20	
Output leak (P00-P07) (P10-P17) (P20-P27) (P30-P33)	IOOH	VOH=V <sub>DD</sub> (High impedance mode)	—	—	+1	μA	
	IOOL	VOL=V <sub>SS</sub> (High impedance mode)	-1 <sup>*5</sup>	—	—		

3

\*<sup>1</sup> Sink-out current from V<sub>DD</sub> to the output pin, which can guarantee the device operation.\*<sup>2</sup> Sink-in current from the output pin to V<sub>SS</sub>, which can guarantee the device operation.\*<sup>3</sup> Do not exceed total current.\*<sup>4</sup> The total current is on the condition of Duty≤50%(same applies to IOH1).

When the duty&gt;50% the total current is calculated by following formula.

Total current = IOL3 x 50/n (When the duty is n%)

&lt;For an example&gt; When IOL3=100mA and n=80%,

Total current = IOL3 x 50/80 = 62.5mA

Current allowed per 1pin is independent of the duty and specified as IOL1 and IOL2.

Do not apply current larger than Absolute Maximum Ratings.

\*<sup>5</sup> The current flowing out the LSI through the pin is described in the negative number.

The applicable maximum current is the absolute value.

For example, -1mA means the maximum current 1mA flows out the LSI through the pin.

\*<sup>6</sup> These values are satisfied with VOH1, VOL1 and VOL2.

## Input / Output pin 3

(V<sub>DD</sub>=1.6 to 5.5V, V<sub>SS</sub>=0V, Ta=-40 to +105°C, unless otherwise specified)

Parameter	Symbol	Condition	Min.	Typ.	Max.	Unit	Measuring circuit
Input current1 (RESET_N)	I <sub>IH1</sub>	V <sub>IH1</sub> =V <sub>DD</sub>	—	—	1	μA	4
	I <sub>IL1</sub>	V <sub>IL1</sub> =V <sub>SS</sub>	-1* <sup>1</sup>	—	—		
Input current2 (P00/TEST0)	I <sub>IL2</sub>	V <sub>IL2</sub> =V <sub>SS</sub> (pull-up mode) <sup>*2</sup>	-1500* <sup>1</sup>	-300* <sup>1</sup>	-20* <sup>1</sup>	kΩ	
	V/I <sub>IL2</sub>	V <sub>IL2</sub> =V <sub>SS</sub> (pull-up mode) <sup>*2</sup>	3.7	10	80	μA	
	I <sub>IH2Z</sub>	V <sub>IH2</sub> =V <sub>DD</sub> (High impedance mode)	—	—	1		
	I <sub>IL2Z</sub>	V <sub>IL2</sub> =V <sub>SS</sub> (High impedance mode)	-1* <sup>1</sup>	—	—		
Input current3 (P01-P07) (P10-P17) (P20-P27) (P30-P33)	I <sub>IL3</sub>	V <sub>IL1</sub> =V <sub>SS</sub> (pull-up mode) <sup>*2</sup>	-250* <sup>1</sup>	-30* <sup>1</sup>	-2* <sup>1</sup>	kΩ	
	V/I <sub>IL3</sub>	V <sub>IL1</sub> =V <sub>SS</sub> (pull-up mode) <sup>*2</sup>	22	100	800		
	I <sub>IH3Z</sub>	V <sub>IH1</sub> =V <sub>DD</sub> (High impedance mode)	—	—	1	μA	
	I <sub>IL3Z</sub>	V <sub>IL1</sub> =V <sub>SS</sub> (High impedance mode)	-1* <sup>1</sup>	—	—		
Input voltage1 (RESET_N) (P01-P07) (P10-P17) (P20-P27) (P30-P33)	V <sub>IH1</sub>	—	0.7 x V <sub>DD</sub>	—	V <sub>DD</sub>	V	5
	V <sub>IL1</sub>	—	0	—	0.3 x V <sub>DD</sub>		
Input voltage2 (P00/TEST0)	V <sub>IH2</sub>	—	0.7 x V <sub>DD</sub>	—	V <sub>DD</sub>	V	
	V <sub>IL2</sub>	—	0	—	0.25 x V <sub>DD</sub>		
Pin capacitance (RESET_N) (P00/TEST0) (P01-P07) (P10-P17) (P20-P27) (P30-P33)	C <sub>PIN</sub>	f = 10kHz Ta = +25°C	—	—	10	pF	—

\*<sup>1</sup> The current flowing out the LSI through the pin is described in the negative number.  
The applicable maximum current is the absolute value.

For example, -1mA means the maximum current 1mA flows out the LSI through the pin.

\*<sup>2</sup> Measurement conditions: Typ. : V<sub>DD</sub> = 3.0V, Max. : V<sub>DD</sub> = 1.6V, Min. : V<sub>DD</sub> = 5.5V

## Synchronous Serial Port

### Slave mode

( $V_{DD}=1.8$  to  $5.5V$ ,  $V_{SS}=0V$ ,  $T_a=-40$  to  $+105^{\circ}C$ , unless otherwise specified)

Parameter	Symbol	Condition	Min.	Typ.	Max.	Unit
SCK input cycle	$t_{SCYC}$	—	1 <sup>*2</sup>	—	—	$\mu s$
SCK input pulse width	$t_{SW}$	—	0.5 <sup>*3</sup>	—	—	$\mu s$
SOUT output delay time	$t_{SD}$	$V_{DD}=2.4$ to $5.5V$	—	—	$100+$ $HSCLK^{*1} \times 3$	ns
		$V_{DD}=1.8$ to $5.5V$	—	—	$200+$ $HSCLK^{*1} \times 3$	ns
SIN input setup time	$t_{SS}$	—	$HSCLK^{*1}$ $\times 1$	—	—	ns
SIN input hold time	$t_{SH}$	—	$80+$ $HSCLK^{*1} \times 3$	—	—	ns

\*1 Cycle of high speed clock

\*2 Need input cycles of HSLCK x8 or longer

\*3 Need input cycles of HSLCK x4 or longer

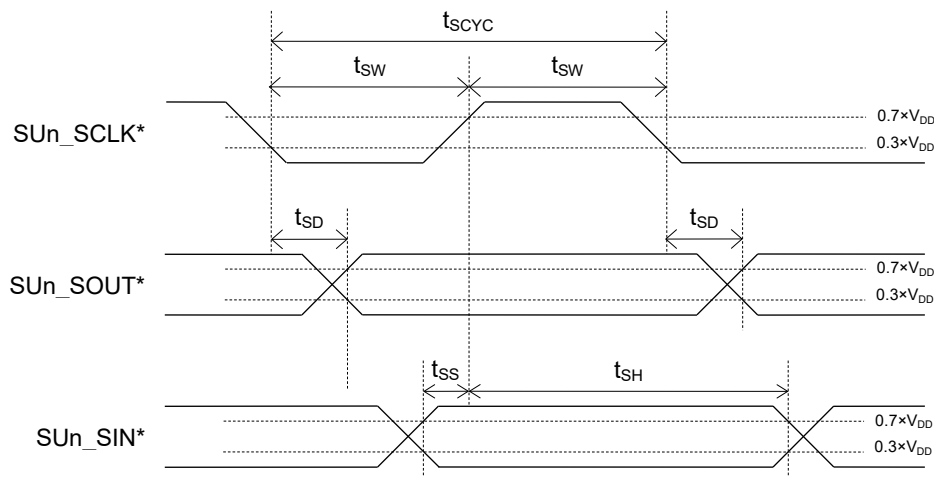

\* 2<sup>nd</sup> to 8<sup>th</sup> function of port, n=0~1

Master mode

( $V_{DD}=1.8$  to  $5.5V$ ,  $V_{SS}=0V$ ,  $T_a=-40$  to  $+105^{\circ}C$ , unless otherwise specified)

Parameter	Symbol	Condition	Min.	Typ.	Max.	Unit
SCK output cycle	$t_{SCYC}$	—	—	$SCLK^{*1}$	—	ns
SCK output pulse width	$t_{SW}$	—	$SCLK^{*1} \times 0.4$	$SCLK^{*1} \times 0.5$	$SCLK^{*1} \times 0.6$	ns
SOUT output delay time	$t_{SD}$	$V_{DD}=2.4$ to $5.5V$	—	—	100	ns
		$V_{DD}=1.8$ to $5.5V$	—	—	160	ns
SIN input setup time	$t_{SS}$	$V_{DD}=2.4$ to $5.5V$	120	—	—	ns
		$V_{DD}=1.8$ to $5.5V$	180	—	—	ns
SIN input hold time	$t_{SH}$	$V_{DD}=2.4$ to $5.5V$	80	—	—	ns
		$V_{DD}=1.8$ to $5.5V$	100	—	—	ns

\*1 Clock cycle selected by bit12~8(SnCK4~0) of the serial port n mode register (SIOOnMOD)  
 $V_{DD} \geq 2.4V$ : min250ns,  $V_{DD} \geq 1.8V$ : min500ns

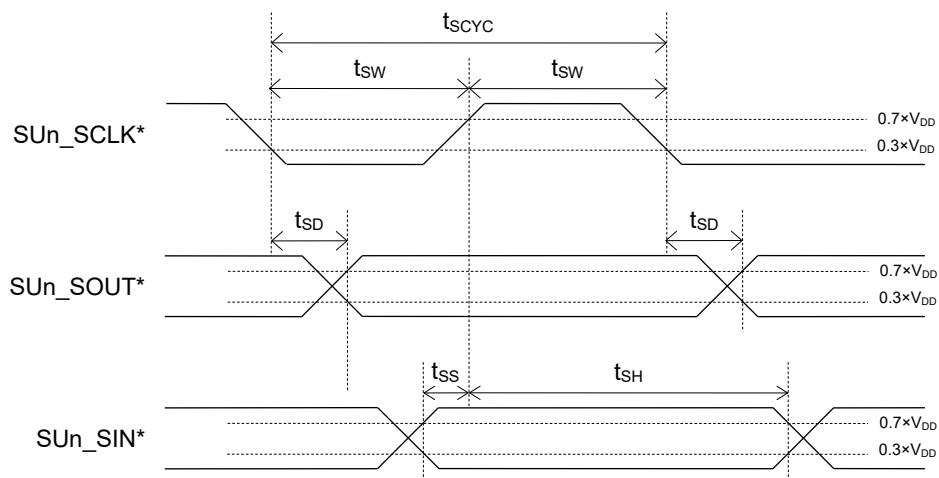

\* 2<sup>nd</sup> to 8<sup>th</sup> function of port, n=0~1



## I<sup>2</sup>C Bus Interface

### Standard Mode (100k bit/s)

(V<sub>DD</sub>=1.8 to 5.5V, V<sub>SS</sub>=0V, Ta=-40 to +105°C, unless otherwise specified)

Parameter	Symbol	Condition	Min.	Typ.	Max.	Unit
SCL clock frequency	f <sub>SCL</sub>	—	0	—	100	kHz
SCL hold time (start/restart condition)	t <sub>HD:STA</sub>	—	4.0	—	—	μs
SCL "L" level time	t <sub>LOW</sub>	—	4.7	—	—	μs
SCL "H" level time	t <sub>HIGH</sub>	—	4.0	—	—	μs
SCL setup time (restart condition)	t <sub>SU:STA</sub>	—	4.7	—	—	μs
SDA hold time	t <sub>HD:DAT</sub>	—	0	—	—	μs
SDA setup time	t <sub>SU:DAT</sub>	—	0.25	—	—	μs
SDA setup time (stop condition)	t <sub>SU:STO</sub>	—	4.0	—	—	μs
Bus-free time	t <sub>BUF</sub>	—	4.7	—	—	μs

When using the I<sup>2</sup>C as the master, configure the I<sup>2</sup>C master n mode register (I2MnMOD) and I<sup>2</sup>C bus 0 mode register (master side, I2UM0MOD) so that meet these specifications.

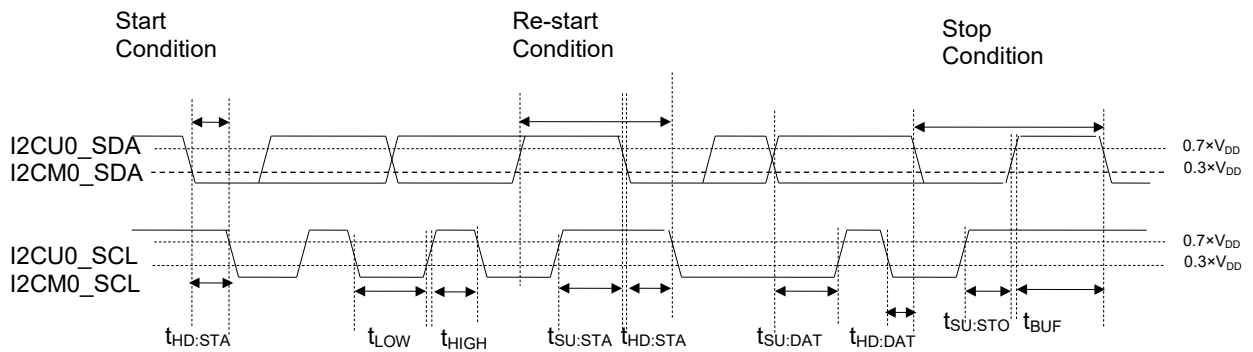

Fast Mode (400k bit/s)

( $V_{DD}=1.8$  to  $5.5V$ ,  $V_{SS}=0V$ ,  $T_a=-40$  to  $+105^{\circ}C$ , unless otherwise specified)

Parameter	Symbol	Condition	Min.	Typ.	Max.	Unit
SCL clock frequency	$f_{SCL}$	—	0	—	400	kHz
SCL hold time (start/restart condition)	$t_{HD:STA}$	—	0.6	—	—	$\mu s$
SCL "L" level time	$t_{LOW}$	—	1.3	—	—	$\mu s$
SCL "H" level time	$t_{HIGH}$	—	0.6	—	—	$\mu s$
SCL setup time (restart condition)	$t_{SU:STA}$	—	0.6	—	—	$\mu s$
SDA hold time	$t_{HD:DAT}$	—	0	—	—	$\mu s$
SDA setup time	$t_{SU:DAT}$	—	0.1	—	—	$\mu s$
SDA setup time (stop condition)	$t_{SU:STO}$	—	0.6	—	—	$\mu s$
Bus-free time	$t_{BUF}$	—	1.3	—	—	$\mu s$

When using the I<sup>2</sup>C as the master, configure the I<sup>2</sup>C master n mode register(I2MnMOD) and I<sup>2</sup>C bus 0 mode register (master side, I2UM0MOD) so that meet these specifications.

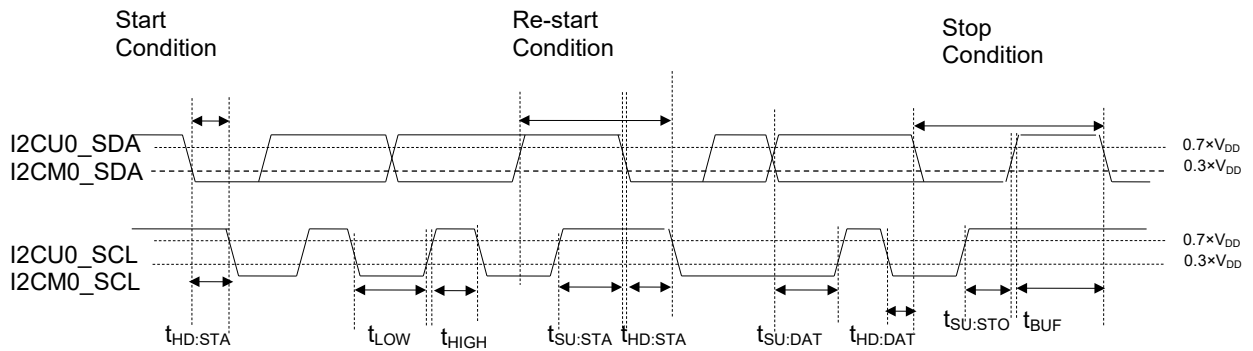

1Mbps Mode (1M bit/s)

( $V_{DD}=2.7$  to  $5.5V$ ,  $V_{SS}=0V$ ,  $T_a=-40$  to  $+105^{\circ}C$ , unless otherwise specified)

Parameter	Symbol	Condition	Min.	Typ.	Max.	Unit
SCL clock frequency	$f_{SCL}$	—	0	—	1000	kHz
SCL hold time (start/restart condition)	$t_{HD:STA}$	—	0.26	—	—	$\mu s$
SCL "L" level time	$t_{LOW}$	—	0.5	—	—	$\mu s$
SCL "H" level time	$t_{HIGH}$	—	0.26	—	—	$\mu s$
SCL setup time (restart condition)	$t_{SU:STA}$	—	0.26	—	—	$\mu s$
SDA hold time	$t_{HD:DAT}$	—	0	—	—	$\mu s$
SDA setup time	$t_{SU:DAT}$	—	0.1	—	—	$\mu s$
SDA setup time (stop condition)	$t_{SU:STO}$	—	0.26	—	—	$\mu s$
Bus-free time	$t_{BUF}$	—	0.5	—	—	$\mu s$

When using the I<sup>2</sup>C as the master, configure the I<sup>2</sup>C master n mode register(I2MnMOD) and I<sup>2</sup>C bus 0 mode register (master side, I2UM0MOD) so that meet these specifications.

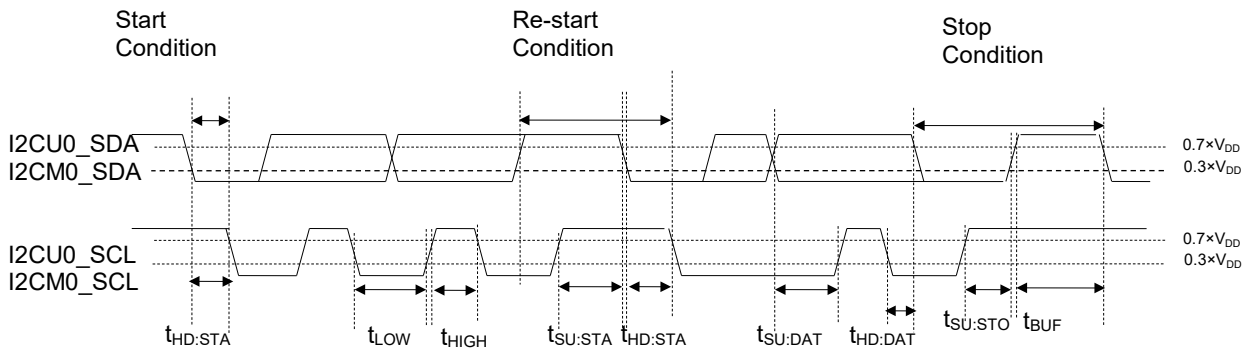

Reset

( $V_{DD}=1.6$  to  $5.5V$ ,  $V_{SS}=0V$ ,  $T_a=-40$  to  $+105^{\circ}C$ , unless otherwise specified)

Parameter	Symbol	Condition	Min.	Typ.	Max.	Unit	Measuring circuit
Reset pulse width	$P_{RST}$	—	2	—	—	ms	1
P00 "H" level setup time	$t_{SP00}$	—	1	—	—	ms	
P00 "H" level hold time <sup>*1</sup>	$t_{HP00}$	—	1	—	—	ms	

\*1: except ISP mode. Refer to the User's manual "25.4 In-System Programming Function" for the timing in ISP mode.

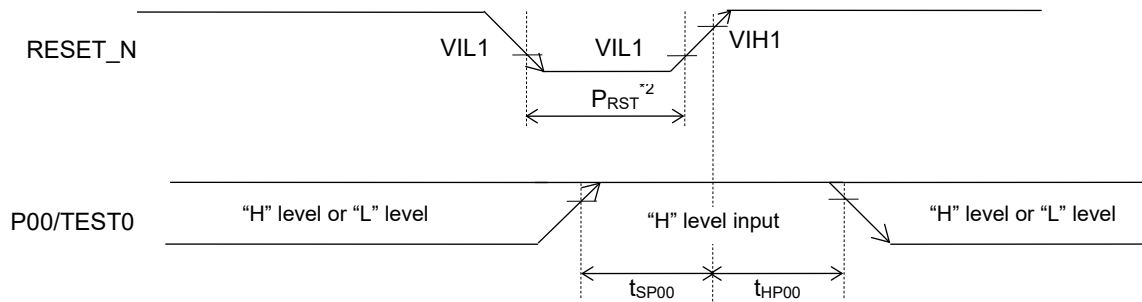

\*2:  $V_{DD}=1.6V$  or over at power on

Note:

- RESET\_N input shorter pulse than the Reset pulse width ( $P_{RST}$ ) valid time should be avoided. The shorter pulse input may cause unexpected behavior.

## Slope of Power supply and Power On Reset

(VSS = 0V, -40 to +105°C, unless otherwise specified)

Parameter	Symbol	Condition	Min.	Typ.	Max.	Unit	Measuring circuit
Power on rising slope	$S_{VR}$	—	—	—	60	V/ms	1
Power on falling slope	$S_{VF}$	—	—	—	2	V/ms	
Power on reset detection voltage	$V_{PORR}$	At Power up (rising)	1.47	1.57	1.80	V	
	$V_{PORF}$	At Power down (falling)	1.33	1.49	1.58	V	
Power on reset minimum pulse width	$P_{POR}$	—	200	—	—	$\mu$ s	
Power on voltage	$V_{INIT}$	At power on	1.8	—	—	V	
CPU operation start time (from the release of reset to the CPU starts to run)	$t_{CPUI}$	—	11	16	—	ms	—

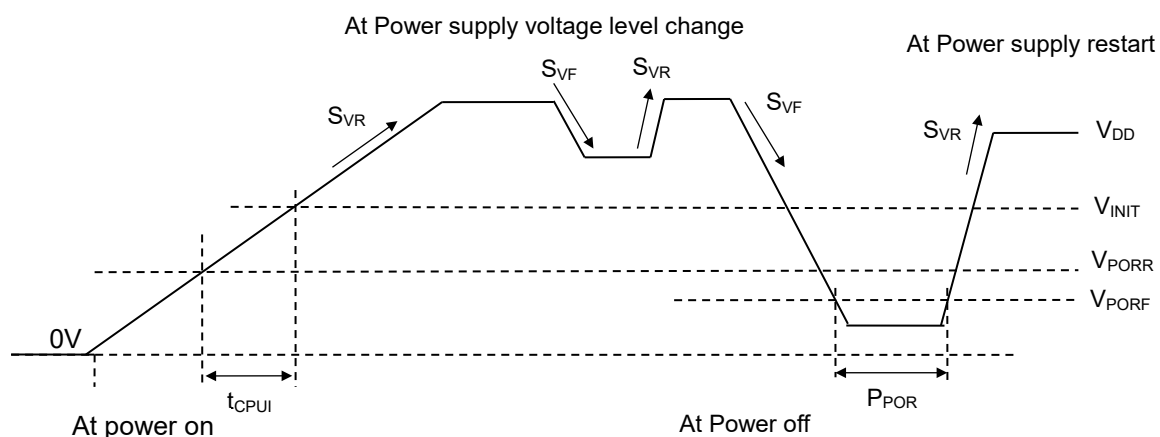

**Note:**

- If a pulse shorter than the Power on reset minimum pulse width is asserted to  $V_{DD}$ , it may cause the MCU malfunction. Apply prevent measurement such as bypass capacitors or external reset input, and so on.
- Start the high-speed clock when the  $V_{DD}$  is within the operating voltage.

## VLS

(V<sub>DD</sub>=1.6 to 5.5V, V<sub>SS</sub>=0V, Ta=-40 to +105°C, unless otherwise specified)

Parameter	Symbol	Condition		Min.	Typ.	Max.	Unit	Measuring circuit
		VLS0LV * <sup>1</sup>						
VLS threshold voltage * <sup>2</sup>	V <sub>VLSR</sub>	00H	Rising	3.86	4.06	4.26	V	1
	V <sub>VLSF</sub>		Falling	3.84	4.00	4.16		
	V <sub>VLSR</sub>	01H	Rising	3.57	3.76	3.95		
	V <sub>VLSF</sub>		Falling	3.55	3.70	3.85		
	V <sub>VLSR</sub>	02H	Rising	2.94	3.11	3.28		
	V <sub>VLSF</sub>		Falling	2.92	3.05	3.18		
	V <sub>VLSR</sub>	03H	Rising	2.85	3.01	3.17		
	V <sub>VLSF</sub>		Falling	2.83	2.95	3.07		
	V <sub>VLSR</sub>	04H	Rising	2.75	2.91	3.07		
	V <sub>VLSF</sub>		Falling	2.73	2.85	2.97		
	V <sub>VLSR</sub>	05H	Rising	2.66	2.81	2.96		
	V <sub>VLSF</sub>		Falling	2.64	2.75	2.86		
	V <sub>VLSR</sub>	06H	Rising	2.56	2.71	2.86		
	V <sub>VLSF</sub>		Falling	2.54	2.65	2.76		
	V <sub>VLSR</sub>	07H	Rising	2.46	2.61	2.76		
	V <sub>VLSF</sub>		Falling	2.44	2.55	2.66		
	V <sub>VLSR</sub>	08H	Rising	2.37	2.51	2.65		
	V <sub>VLSF</sub>		Falling	2.35	2.45	2.55		
	V <sub>VLSR</sub>	09H	Rising	1.98	2.11	2.24		
	V <sub>VLSF</sub>		Falling	1.96	2.05	2.14		
V <sub>VLSR</sub>	0AH	Rising	1.89	2.01	2.13			
V <sub>VLSF</sub>		Falling	1.87	1.95	2.03			
V <sub>VLSR</sub>	0BH	Rising	1.79	1.91	2.03			
V <sub>VLSF</sub>		Falling	1.77	1.85	1.93			
VLS Current	I <sub>VLS</sub>	—		—	50	—	nA	

\*<sup>1</sup> Bit3~Bit0 of voltage level detection circuit 0 level register (VLS0LV).\*<sup>2</sup> The Data VLS0LV = 0CH~0FH is not available to use, if the data is specified it will the same spec as that 0BH is specified.

## Analog Comparator

(V<sub>DD</sub>=1.8 to 5.5V, V<sub>SS</sub>=0V, Ta=-40 to +105°C, unless otherwise specified)

Parameter	Symbol	Condition	Min.	Typ.	Max.	Unit	Measuring circuit
Comparator same phase input voltage range	V <sub>CMR</sub>	—	0.1	—	V <sub>DD</sub> -1.5	V	1
Comparator0 input offset	V <sub>CMOF</sub>	Ta=+25°C, V <sub>DD</sub> =5.0V	—	5	—	mV	
Comparator Reference Voltage	V <sub>CMREF</sub>	—	0.75	0.8	0.85	V	

## Successive Approximation Type A/D Converter

( $V_{DD}=1.8$  to  $5.5V$ ,  $V_{SS}=0V$ ,  $T_a=-40$  to  $+105^{\circ}C$ , unless otherwise specified)

Parameter	Symbol	Condition	Min.	Typ.	Max.	Unit
Resolution	$n_{AD}$	—	—	—	10	bit
Overall error	—	$4.5V \leq \text{Reference voltage}^{*1} \leq 5.5V$	-3.5	1.2	3.5	LSB
Integral non-linearity error	$INL_{AD}$	$2.7V \leq \text{Reference voltage}^{*1} \leq 5.5V$	-4	—	4	
		$2.2V \leq \text{Reference voltage}^{*1} < 2.7V$	-6	—	6	
		$1.8V \leq \text{Reference voltage}^{*1} < 2.2V$	-10	—	10	
		Reference voltage = Internal reference voltage	-15	—	15	
Differential non-linearity error	$DNL_{AD}$	$2.7V \leq \text{Reference voltage}^{*1} \leq 5.5V$	-3	—	3	
		$2.2V \leq \text{Reference voltage}^{*1} < 2.7V$	-5	—	5	
		$1.8V \leq \text{Reference voltage}^{*1} < 2.2V$	-9	—	9	
		Reference voltage = Internal reference voltage	-14	—	14	
Zero-scale error	ZSE	$R_I \leq 1k\Omega$	-6	—	6	
Full-scale error	FSE	$R_I \leq 1k\Omega$	-6	—	6	
A/D reference voltage	$V_{REF}$	—	1.8	—	$V_{DD}$	V
Internal reference voltage	$V_{REFI}$	—	1.5	1.55	1.6	
Conversion time	$t_{CONV}$	$4.5V \leq V_{DD} \leq 5.5V$	2.25	—	427	$\mu s$
		$2.2V \leq V_{DD} \leq 5.5V$	4.5	—	427	
		$1.8V \leq V_{DD} \leq 5.5V$	18	—	427	

\*1 :  $V_{DD}$  or  $P23/V_{REF}$  is selected for the reference voltage of Successive Approximation Type A/D Converter by setting bit5( $V_{REFP1}$ ) and bit4( $V_{REFP0}$ ) of SA-ADC TEMP/VREF control register( $V_{REFCON}$ ).

The current flows during the ADC sampling as it takes charging. Make the output impedance of the analog signal source  $1k\Omega$  or smaller. Also, putting  $0.1\mu F$  capacitor on the ADC input pin is recommended to reduce the noise.

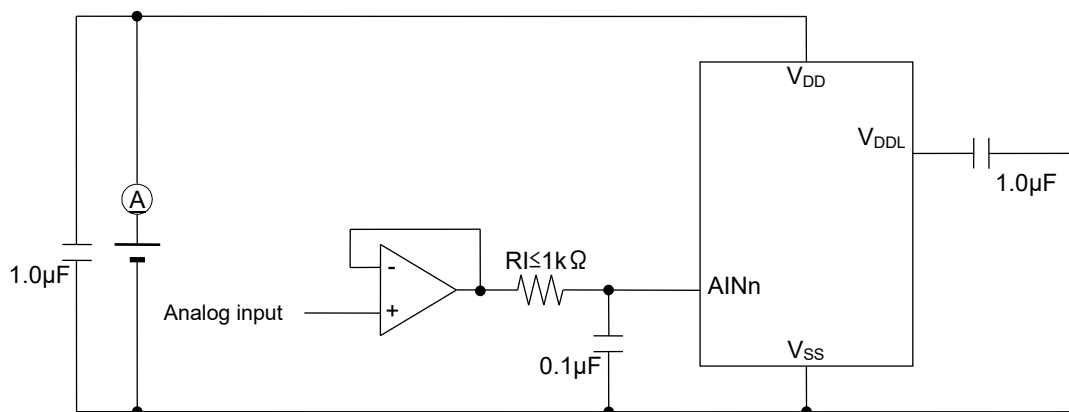

## D/A Converter

(V<sub>DD</sub>=1.8 to 5.5V, V<sub>SS</sub>=0V, Ta=-40 to +105°C, unless otherwise specified)

Parameter	Symbol	Condition	Min.	Typ.	Max.	Unit
Resolution	n <sub>DA</sub>	—	—	—	8	bit
Conversion cycle	tc	—	10	—	—	μs
Integral non-linearity error	INL <sub>DA</sub>	RL=4MΩ	-2	—	2	LSB
Differential non-linearity error	DNL <sub>DA</sub>	RL=4MΩ	-1	—	1	
Output impedance	R <sub>o</sub>	DACEN bit of D/A converter enable register =1	3	6	9	kΩ

## Reference Voltage Output

(V<sub>DD</sub>=1.8 to 5.5V, V<sub>SS</sub>=0V, Ta=-40 to +105°C, unless otherwise specified)

Parameter	Symbol	Condition	Min.	Typ.	Max.	Unit
Output voltage	V <sub>REFO</sub>	—	—	1.55	—	V
Output impedance	R <sub>VREFO</sub>	—	—	—	500	kΩ

## Flash Memory

(V<sub>SS</sub>= 0V)

Parameter	Symbol	Condition	Range	Unit	
Operating temperature	T <sub>OP</sub>	Data flash memory, At write/erase	-40 to +85	°C	
		Flash ROM, At write/erase	0 to +40		
Operating voltage	V <sub>DD</sub>	At write/erase	+1.8 to +5.5	V	
Maximum rewrite count	CEPD	Data Flash (4Kbyte)	10000	times	
	CEPP	Program Flash	100		
Erase unit	—	Block erase	Program Flash	16K	B
			Data Flash	All area	
	—	Sector erase	Program Flash	1K	B
			Data Flash	128	
Erase time (Max.)	—	Block erase / Sector erase	50	ms	
Write unit	—	Program Flash	4	B	
		Data Flash	1		
Write time (Max.)	—	Program Flash	80	μs	
	—	Data Flash	40		
Data retention period	YDR	—	15	years	



Measuring circuit

Measuring circuit 1

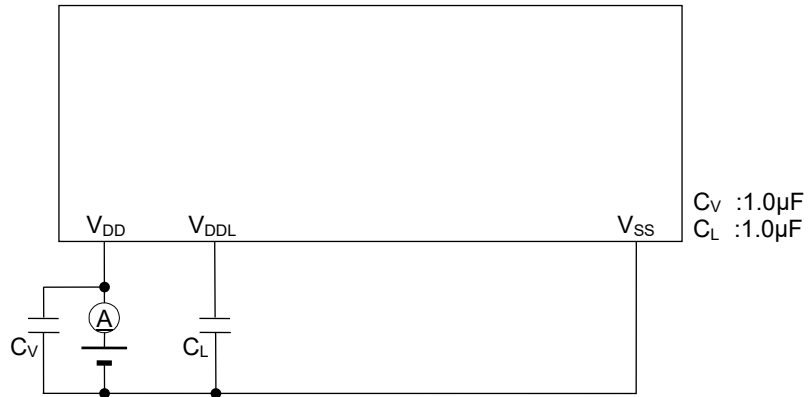

Measuring circuit 2

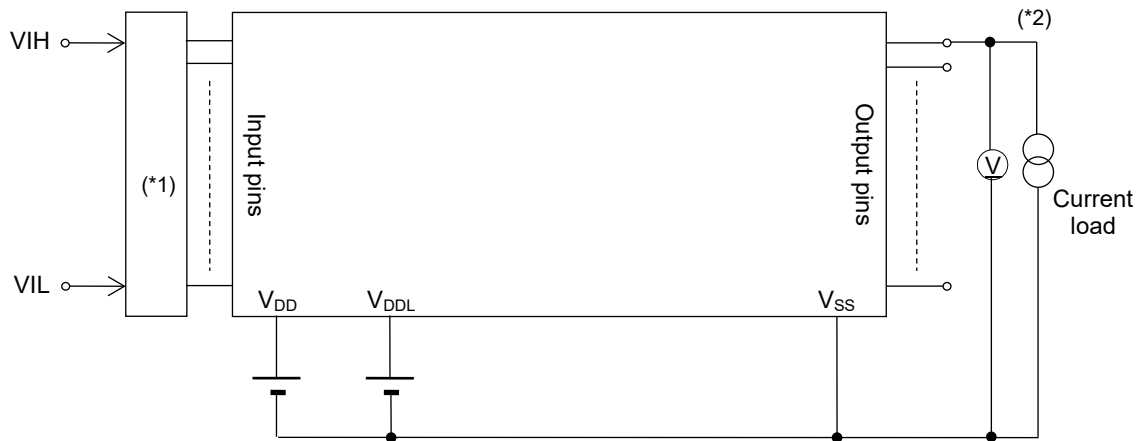

(\*1) Input logic circuit to determine the specified measuring conditions  
 (\*2) Measured connecting specified pins

Measuring circuit 3

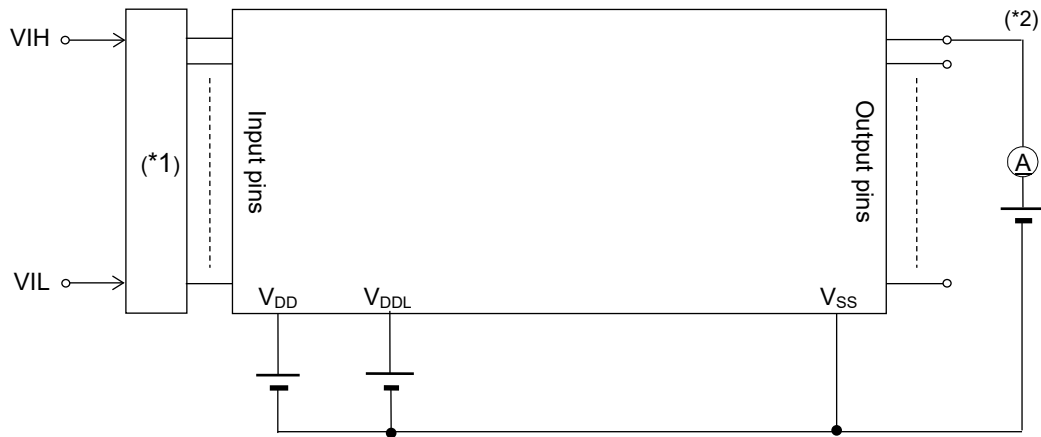

(\*1) Input logic circuit to determine the specified measuring conditions  
 (\*2) Measured connecting specified pins

Measuring circuit 4

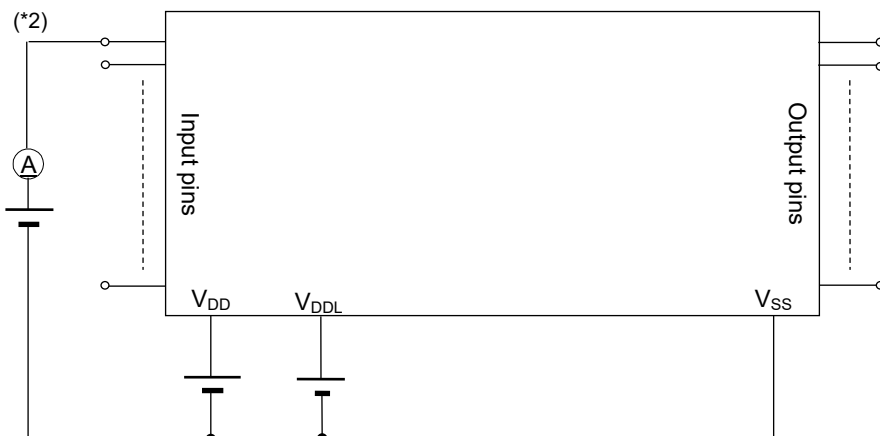

(\*)2 Measured connecting specified pins

Measuring circuit 5

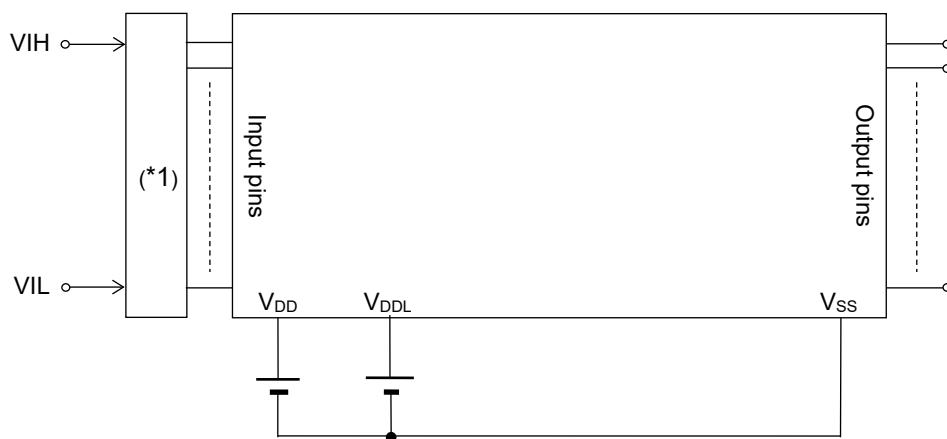

(\*)1 Input logic circuit to determine the specified measuring conditions

## Characteristics graphs

These Graphs on the following pages are references for designing an application.

IOH vs V<sub>DD</sub>-VOH1 (V<sub>DD</sub>=5V TYP.)

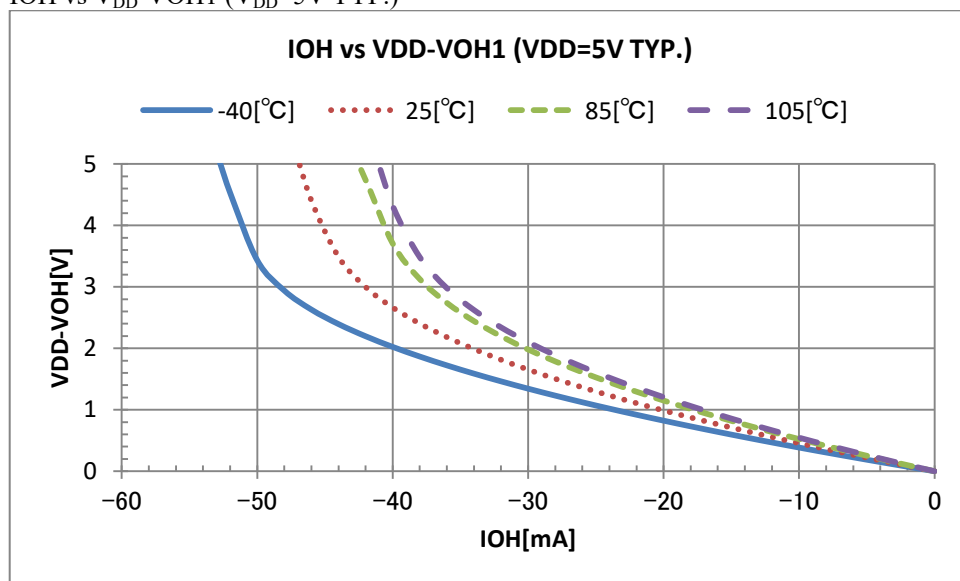

IOH vs V<sub>DD</sub>-VOH1 (V<sub>DD</sub>=3V TYP.)

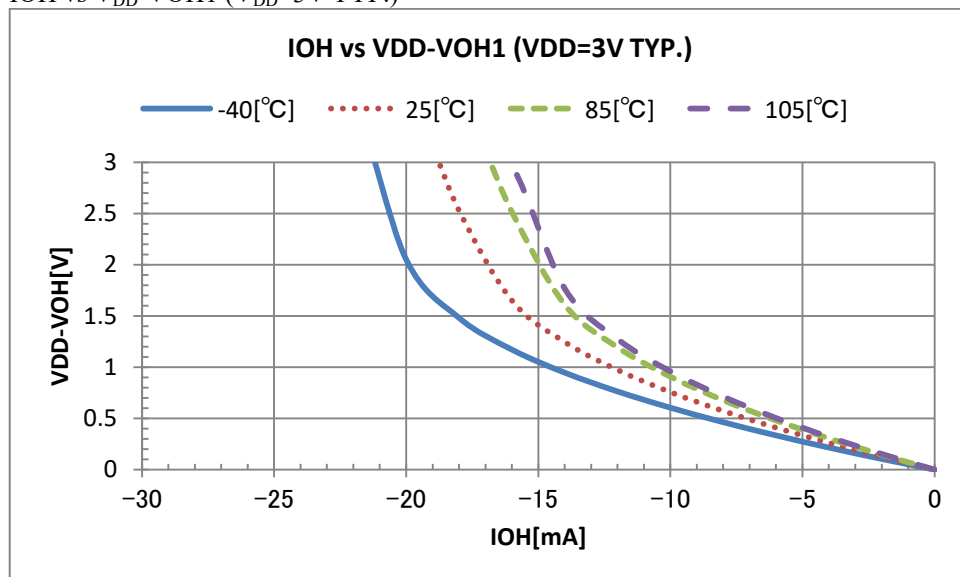

IOL vs VOL1 (V<sub>DD</sub>=5V TYP.)

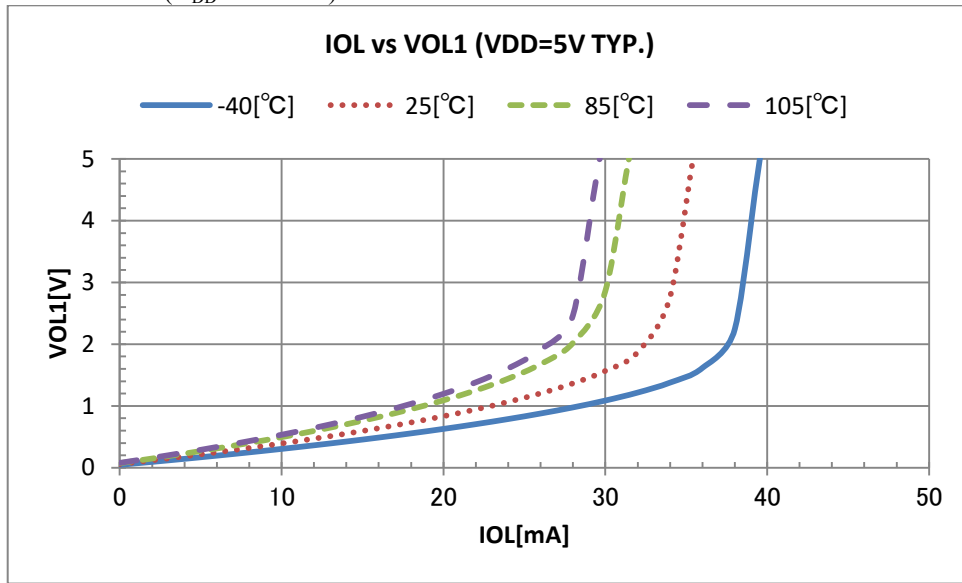

IOL vs VOL1 (V<sub>DD</sub>=3V TYP.)

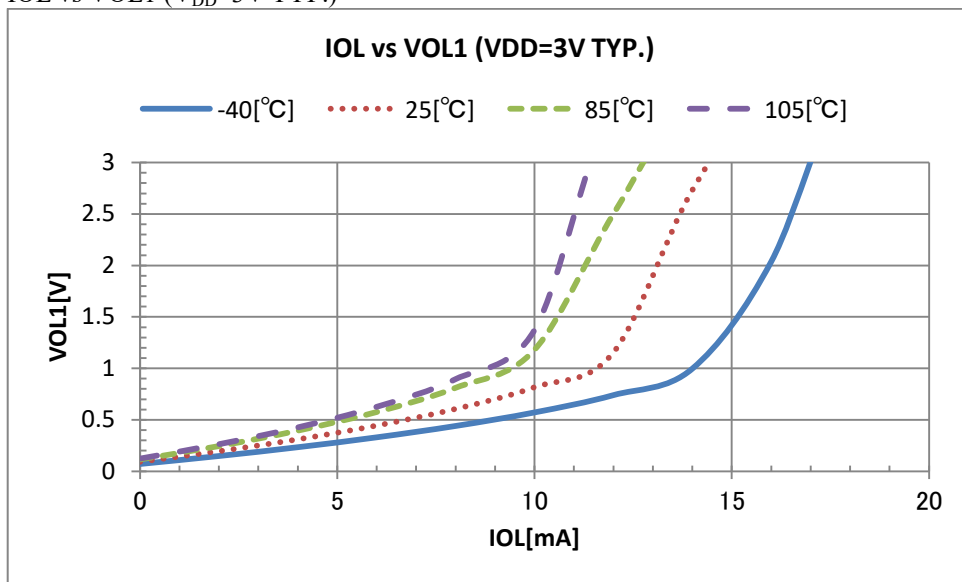

IOL vs VOL2 (V<sub>DD</sub>=5V TYP.)

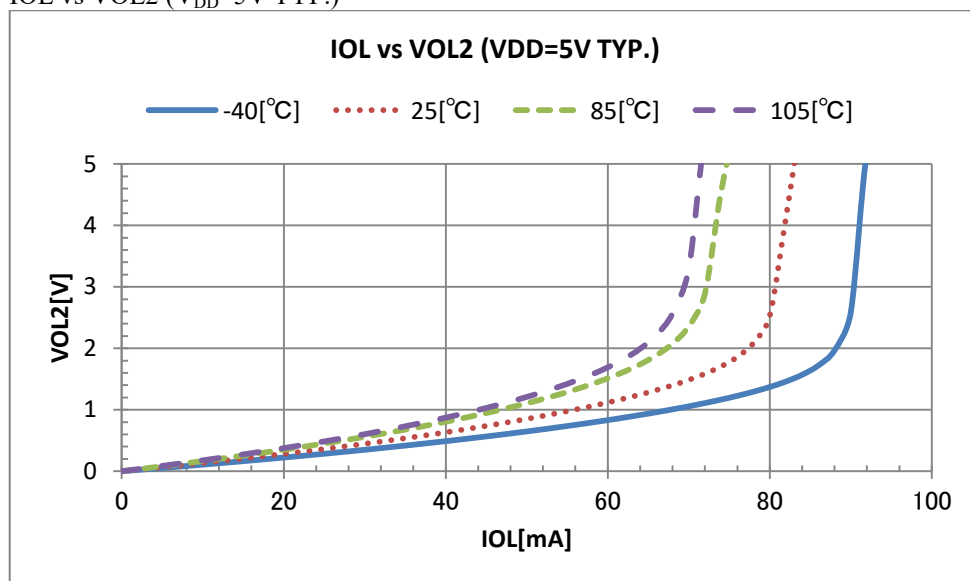

IOL vs VOL2 (V<sub>DD</sub>=3V TYP.)

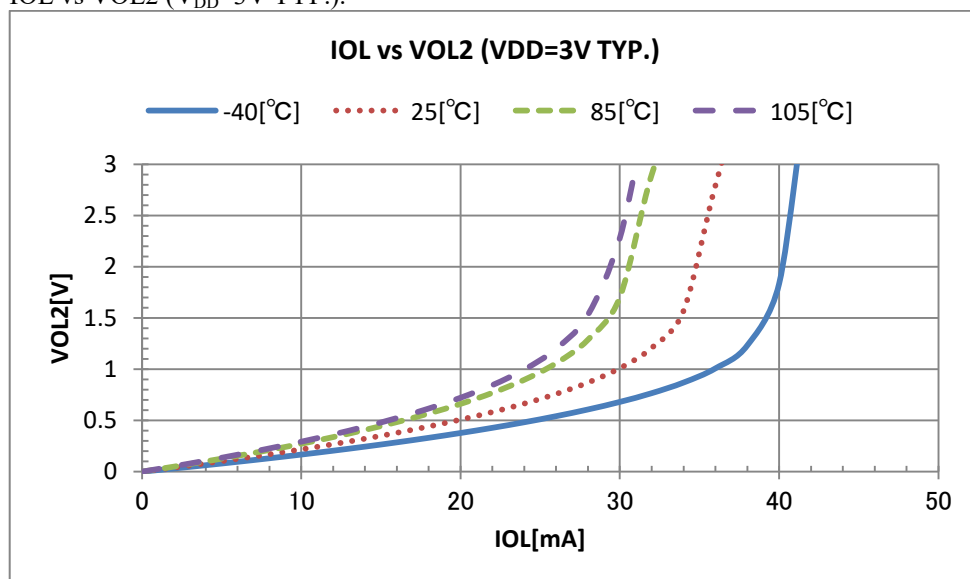

V<sub>DD</sub> VS I<sub>IH2</sub> (TYP. V<sub>IL2</sub>=V<sub>SS</sub>)

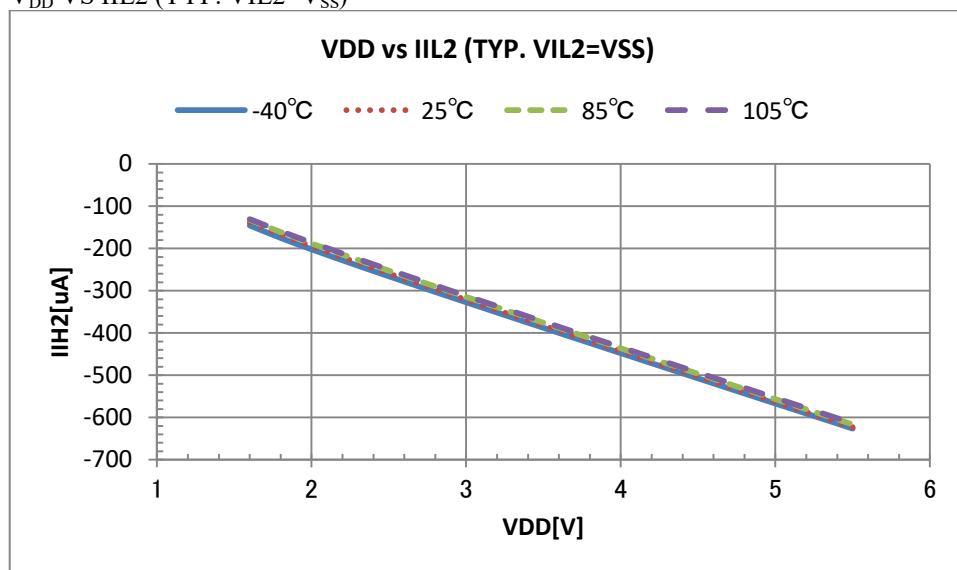

Pull-up resistor

V<sub>DD</sub> VS V<sub>DD</sub>/I<sub>IH2</sub> (TYP. V<sub>IL2</sub>=V<sub>SS</sub>)

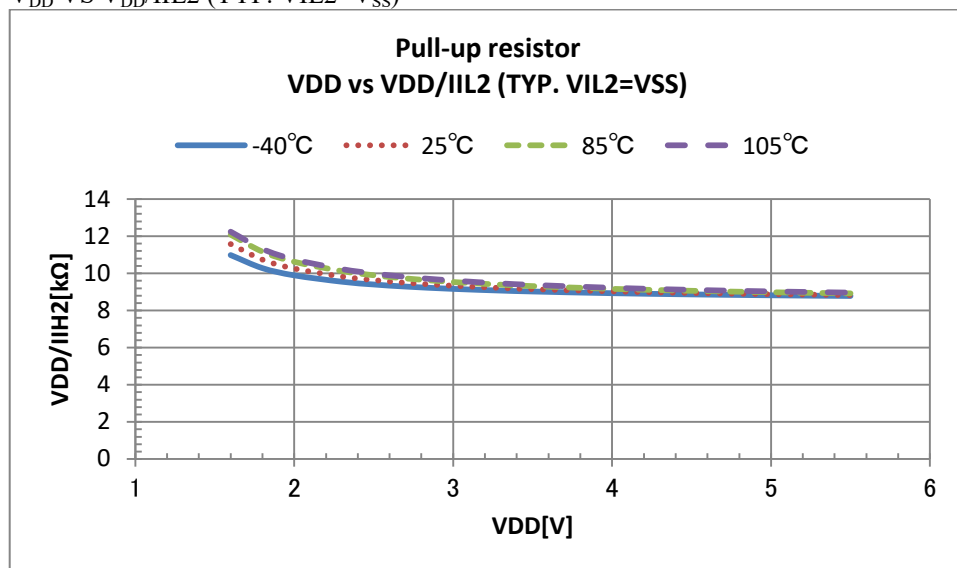

V<sub>DD</sub> VS I<sub>IH3</sub> (TYP. V<sub>IL3</sub>=V<sub>SS</sub>)

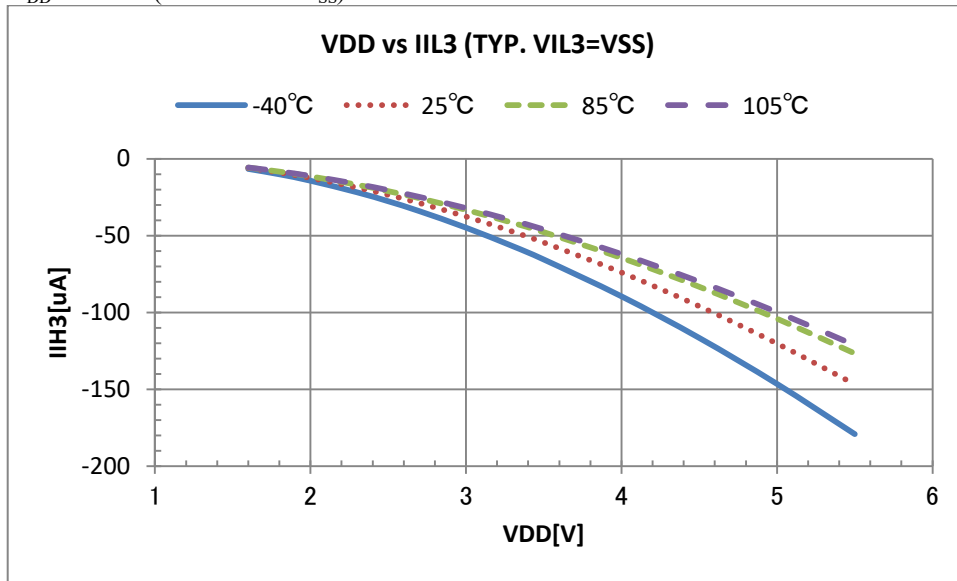

Pull-up resistor

V<sub>DD</sub> VS V<sub>DD</sub>/I<sub>IH3</sub> (TYP. V<sub>IL3</sub>=V<sub>SS</sub>)

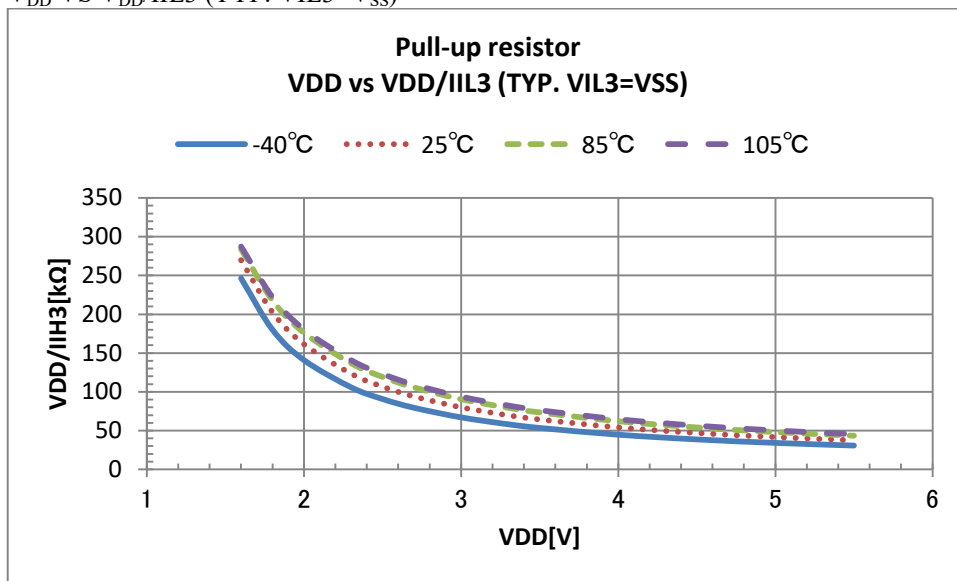



Product: ML62Q1323, ML62Q1324, ML62Q1325, ML62Q1333, ML62Q1334, ML62Q1335

Current consumption VS operating frequency of CPU

$V_{DD}=3V$ , temp= $25^{\circ}C$  CPU 16MHz Wait mode (TYP.)

Stop the clock supply to peripherals.

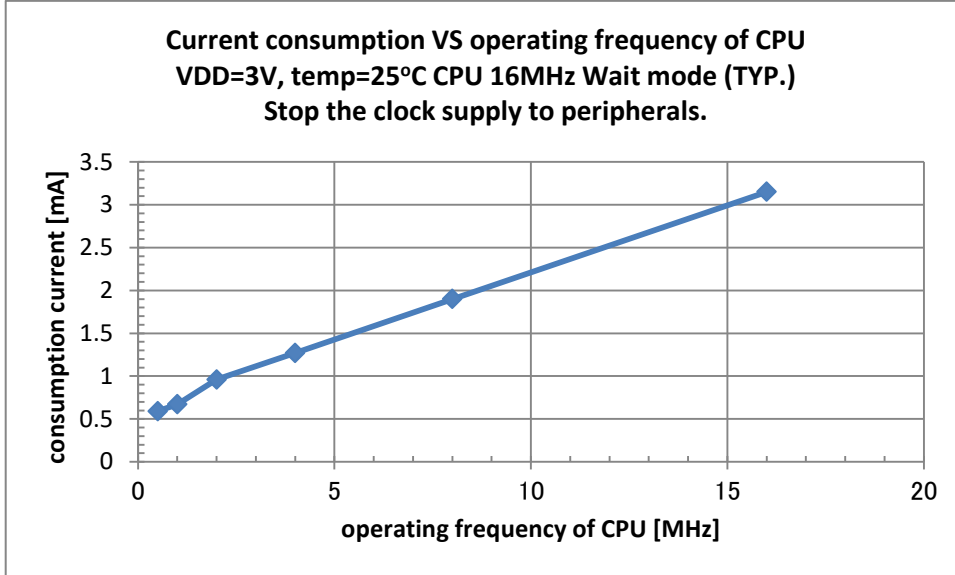

$V_{DD}=3V$ , temp= $25^{\circ}C$  CPU 16MHz no Wait mode (TYP.)

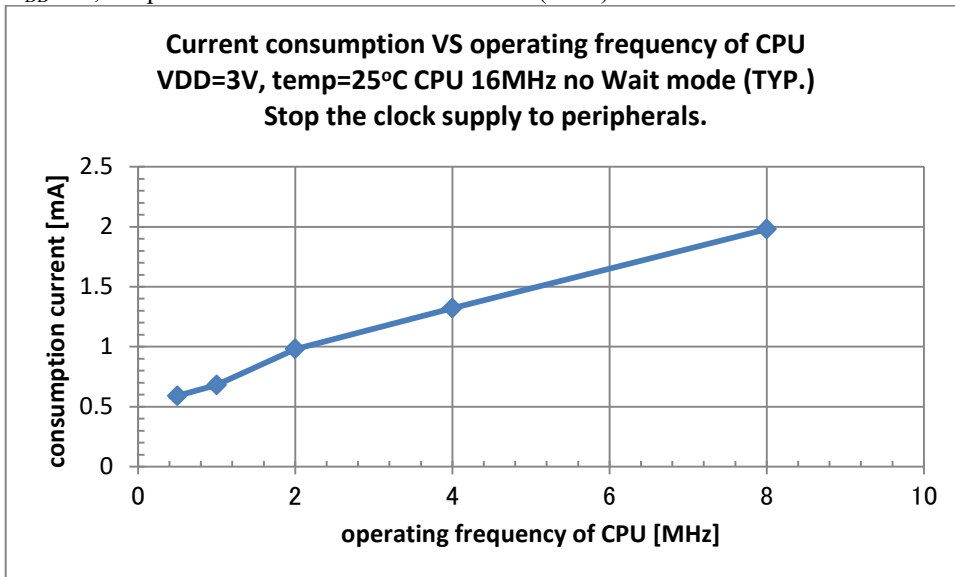

Product: ML62Q1323, ML62Q1324, ML62Q1325, ML62Q1333, ML62Q1334, ML62Q1335

Current consumption VS operating frequency of CPU

V<sub>DD</sub>=3V, temp=25°C CPU 24MHz Wait mode (TYP.)

Stop the clock supply to peripherals.

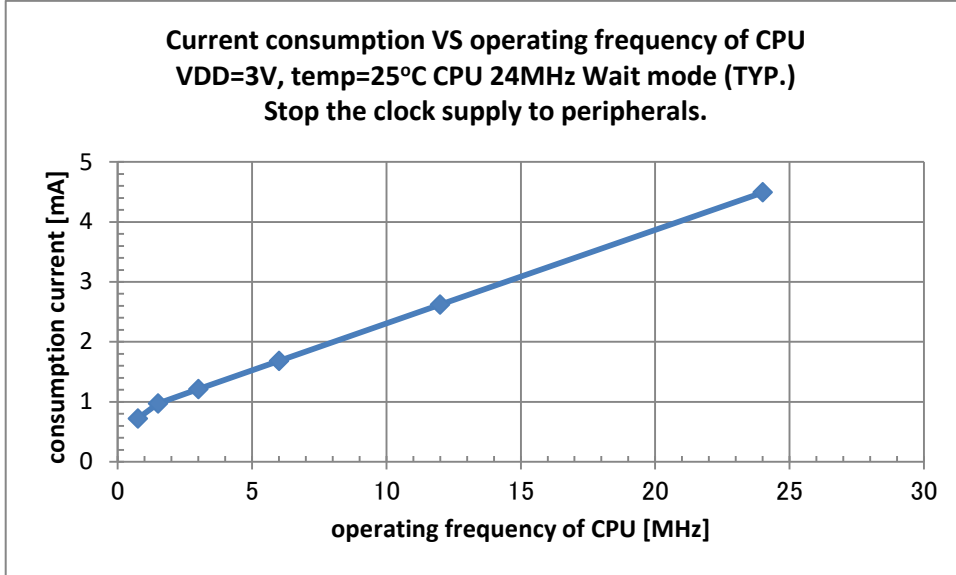

V<sub>DD</sub>=3V, temp=25°C CPU 24MHz no Wait mode (TYP.)

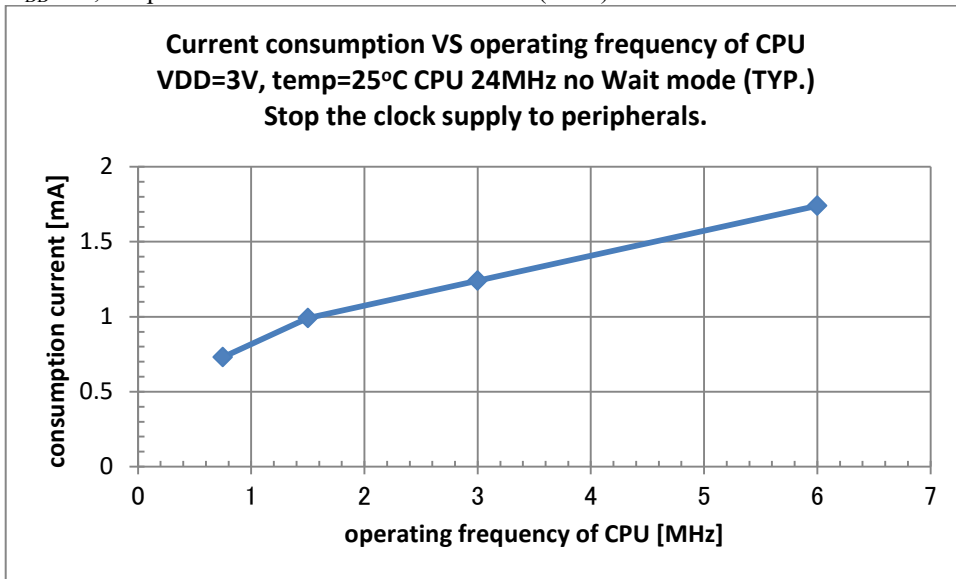

Product: ML62Q1345, ML62Q1346, ML62Q1347, ML62Q1365, ML62Q1366, ML62Q1367

Current consumption VS operating frequency of CPU  
V<sub>DD</sub>=3V, temp=25°C CPU 16MHz Wait mode (TYP.)  
Stop the clock supply to peripherals.

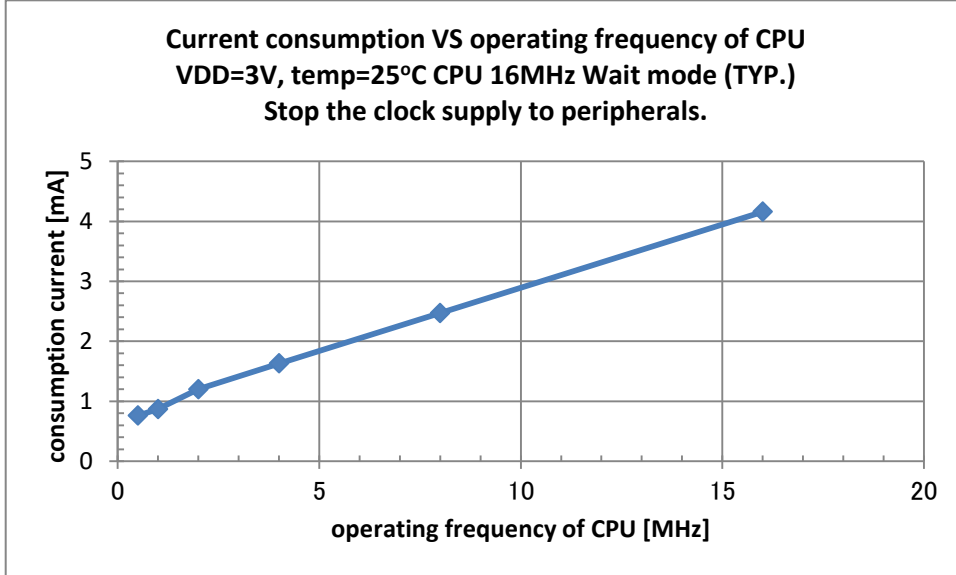

V<sub>DD</sub>=3V, temp=25°C CPU 16MHz no Wait mode (TYP.)

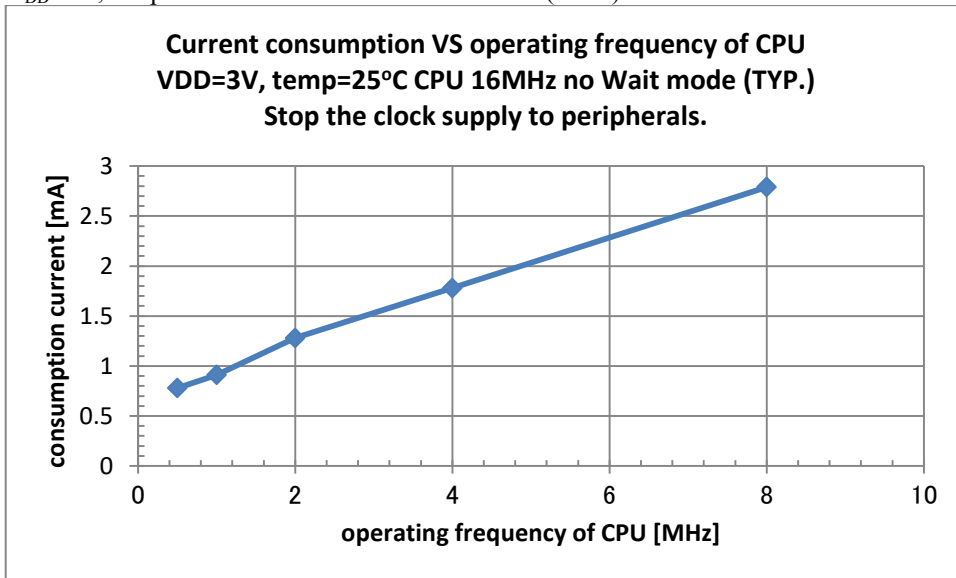

Product: ML62Q1345, ML62Q1346, ML62Q1347, ML62Q1365, ML62Q1366, ML62Q1367

Current consumption VS operating frequency of CPU

V<sub>DD</sub>=3V, temp=25 °C CPU 24MHz Wait mode (TYP.)

Stop the clock supply to peripherals.

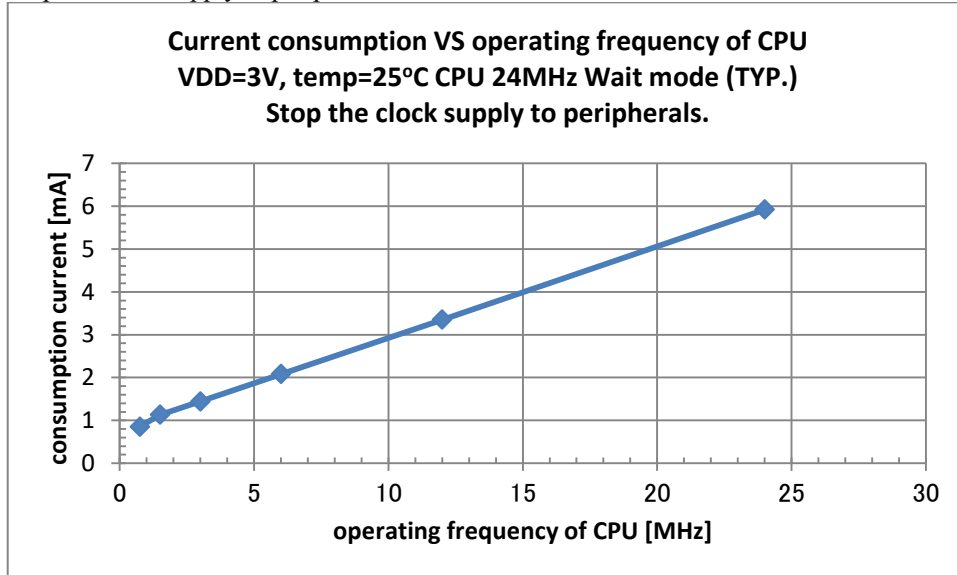

V<sub>DD</sub>=3V, temp=25 °C CPU 24MHz no Wait mode (TYP.)

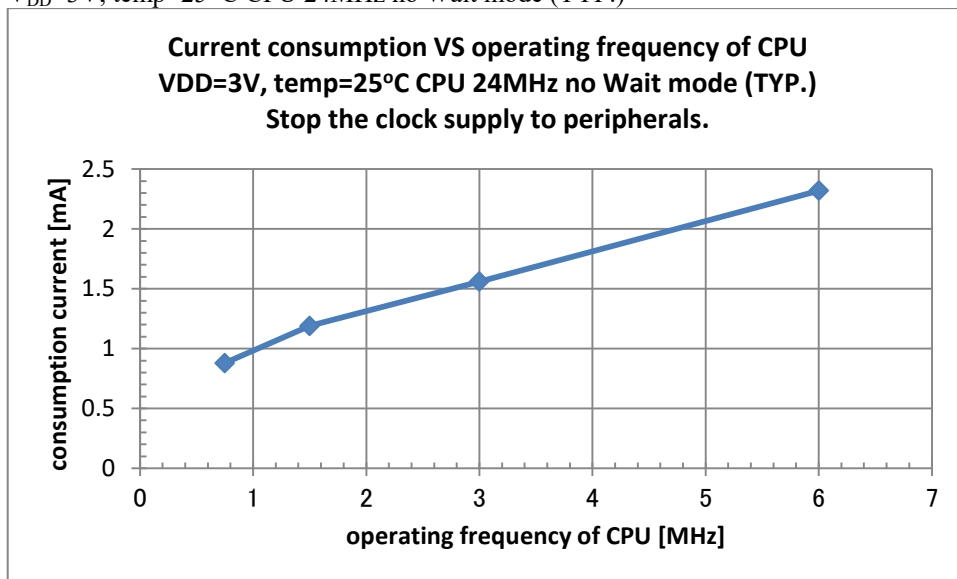

Consumption current of ADC VS operating voltage  
PLL frequency=16MHz temp=25 °C ch0 V<sub>REF</sub>=V<sub>DD</sub>

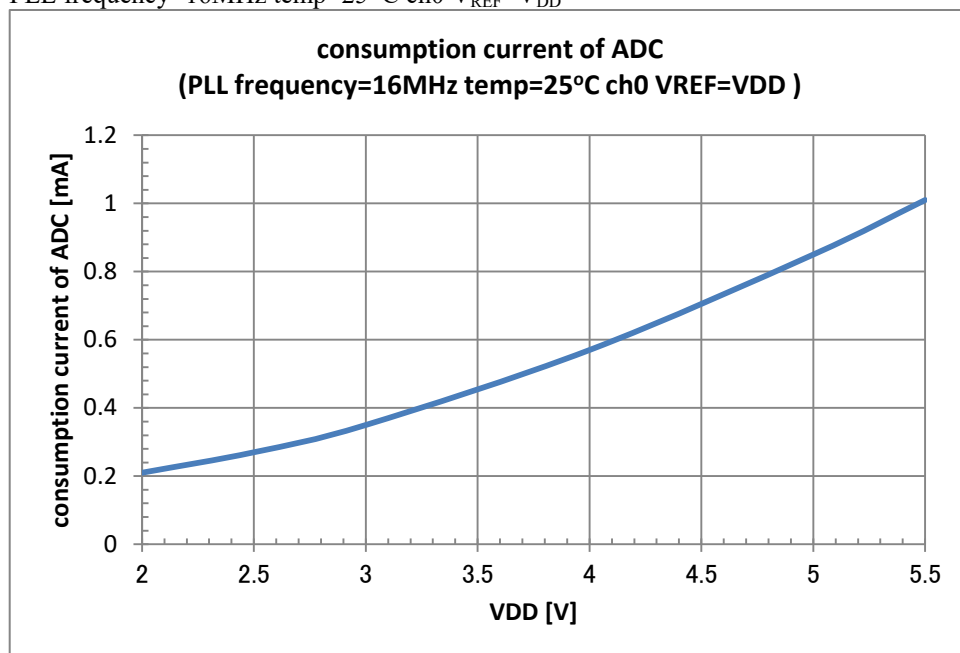

TEMP VS Low-speed RC oscillator frequency accuracy 1 without software adjustment (Typ.)

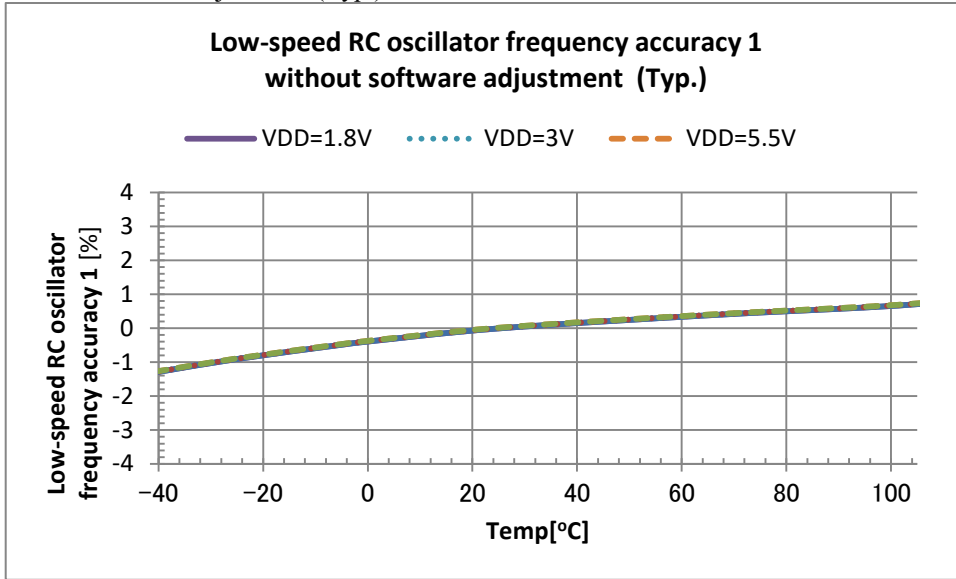

TEMP VS PLL oscillator frequency accuracy 1 without software adjustment (24MHz Typ.)

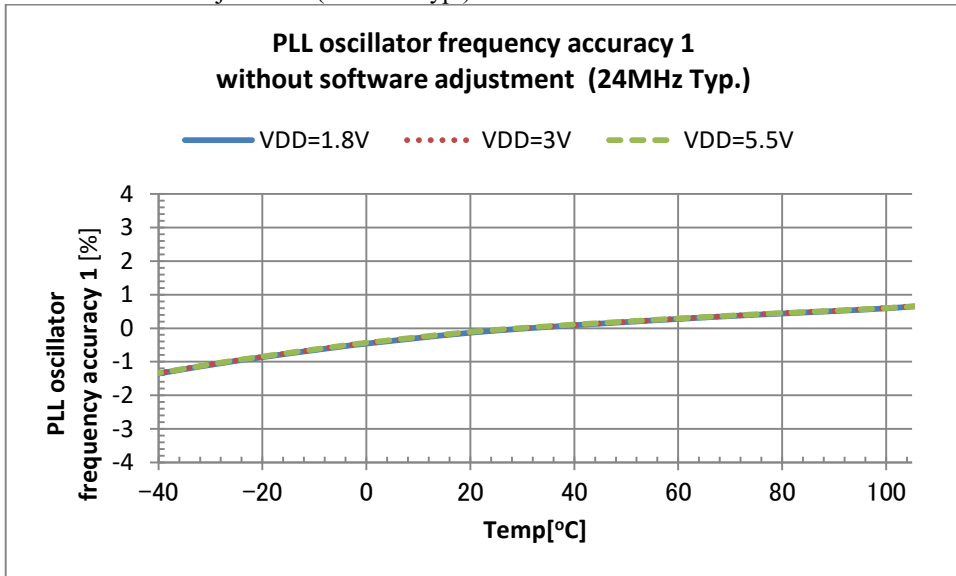

PACKAGE DIMENSIONS

ML62Q1323/1324/1325 16pin SSOP Package

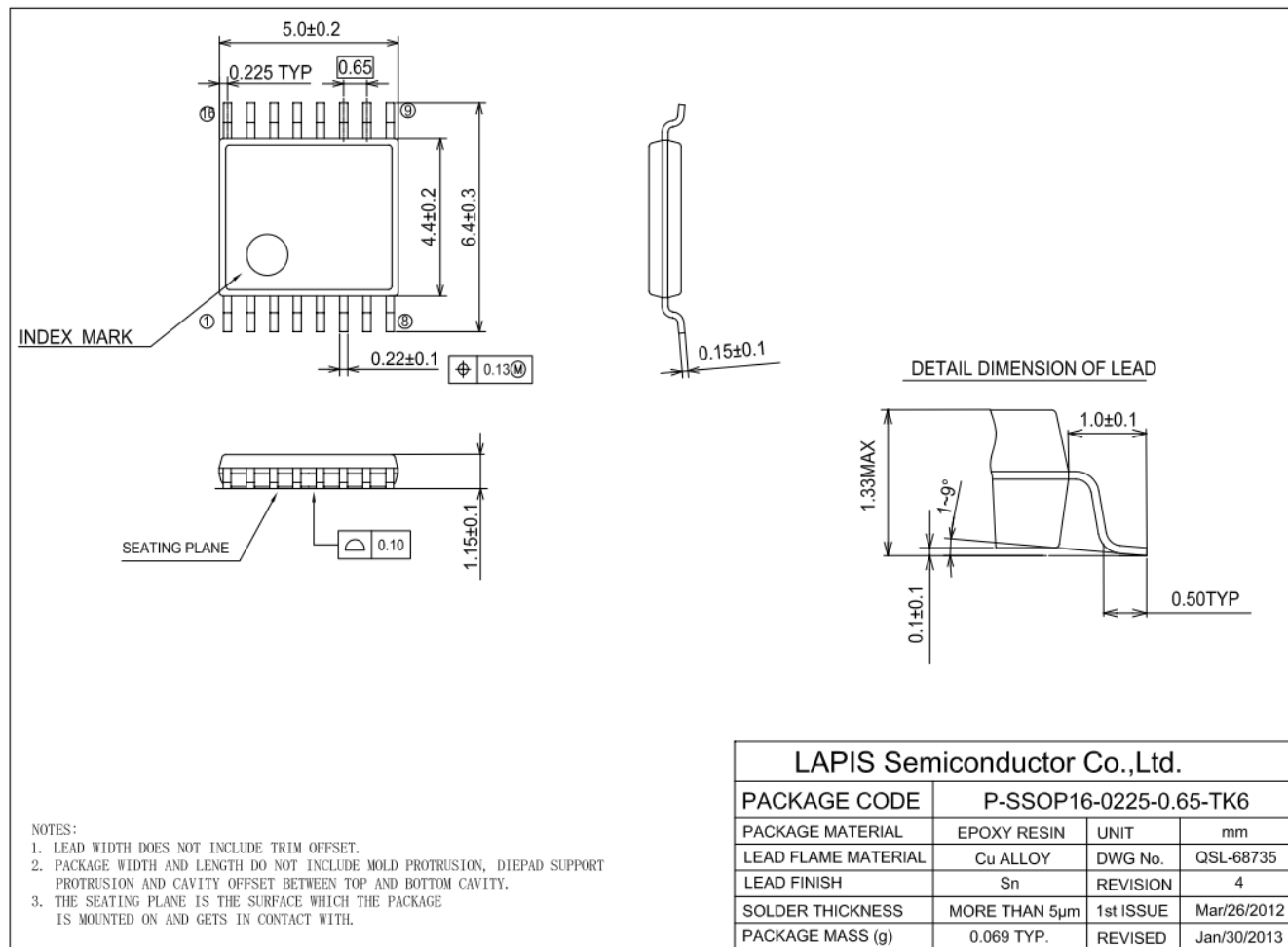

(Unit: mm)

Notes for Mounting the Surface Mount Type Package

The surface mount type packages are very susceptible to heat in reflow mounting and humidity absorbed in storage. Therefore, before you perform reflow mounting, contact a ROHM sales office for the product name, package name, pin number, package code and desired mounting conditions (reflow method, temperature and times).

ML62Q1323/1324/1325 16pin WQFN Package

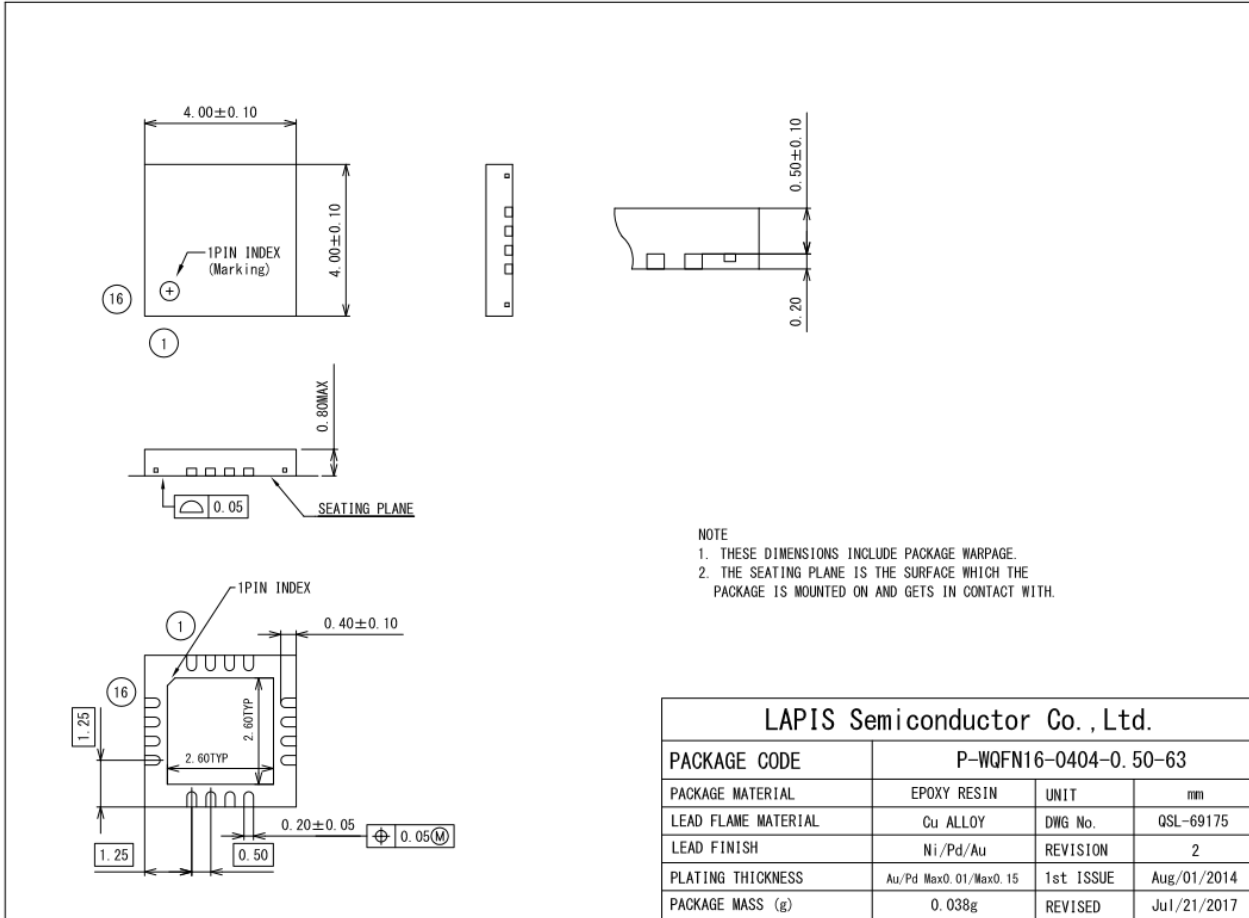

(Unit: mm)

Notes for Mounting the Surface Mount Type Package

The surface mount type packages are very susceptible to heat in reflow mounting and humidity absorbed in storage. Therefore, before you perform reflow mounting, contact a ROHM sales office for the product name, package name, pin number, package code and desired mounting conditions (reflow method, temperature and times).

Note for the package with exposed die pad

The die pad is exposed on the bottom of WQFN package. Make the die pad electrically open when soldering onto the PCB.



ML62Q1333/1334/1335 20pin TSSOP Package

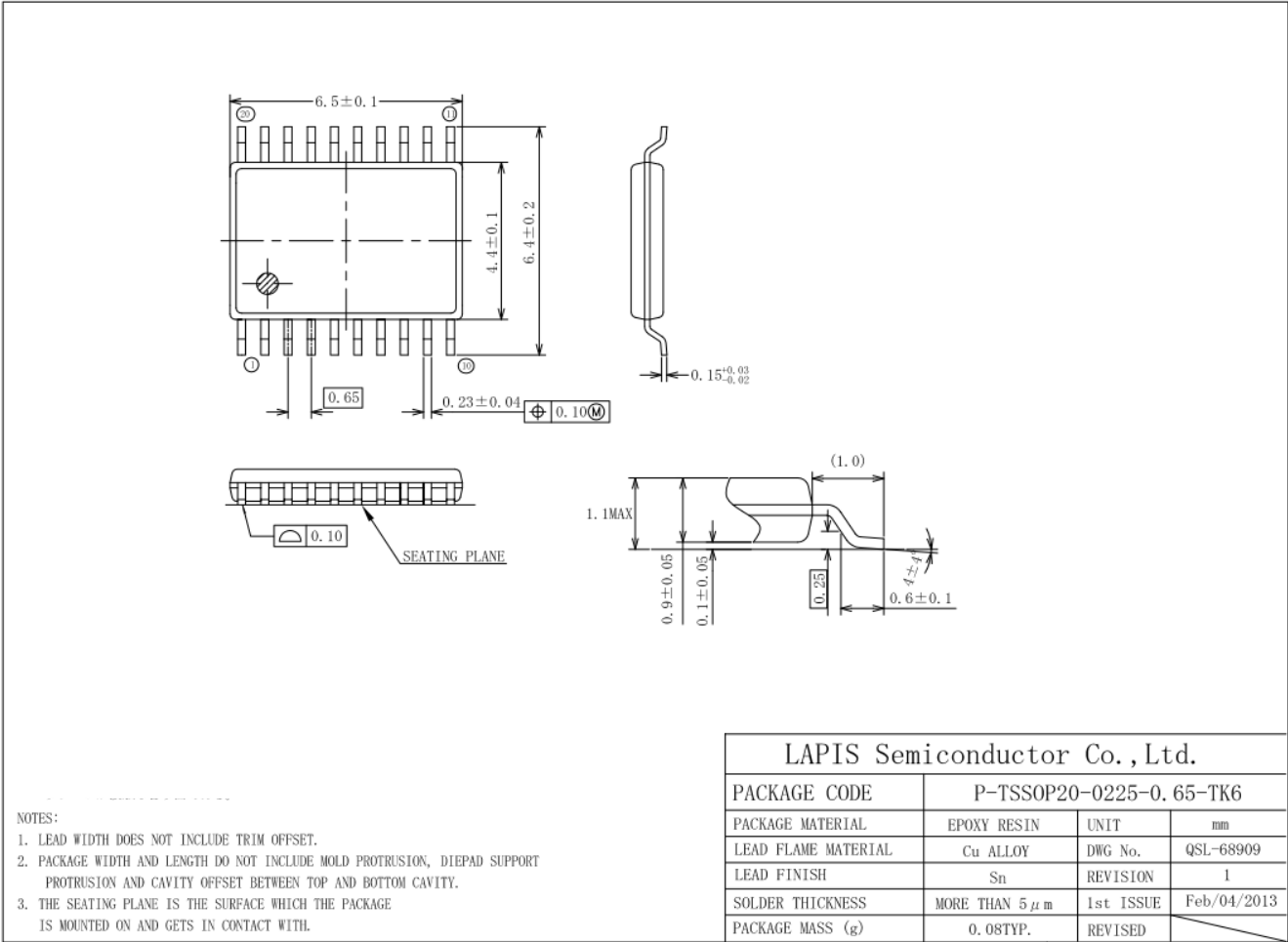

NOTES:

1. LEAD WIDTH DOES NOT INCLUDE TRIM OFFSET.
2. PACKAGE WIDTH AND LENGTH DO NOT INCLUDE MOLD PROTRUSION, DIEPAD SUPPORT PROTRUSION AND CAVITY OFFSET BETWEEN TOP AND BOTTOM CAVITY.
3. THE SEATING PLANE IS THE SURFACE WHICH THE PACKAGE IS MOUNTED ON AND GETS IN CONTACT WITH.

(Unit: mm)

Notes for Mounting the Surface Mount Type Package

The surface mount type packages are very susceptible to heat in reflow mounting and humidity absorbed in storage. Therefore, before you perform reflow mounting, contact a ROHM sales office for the product name, package name, pin number, package code and desired mounting conditions (reflow method, temperature and times).

ML62Q1345/1346/1347 24pin WQFN Package

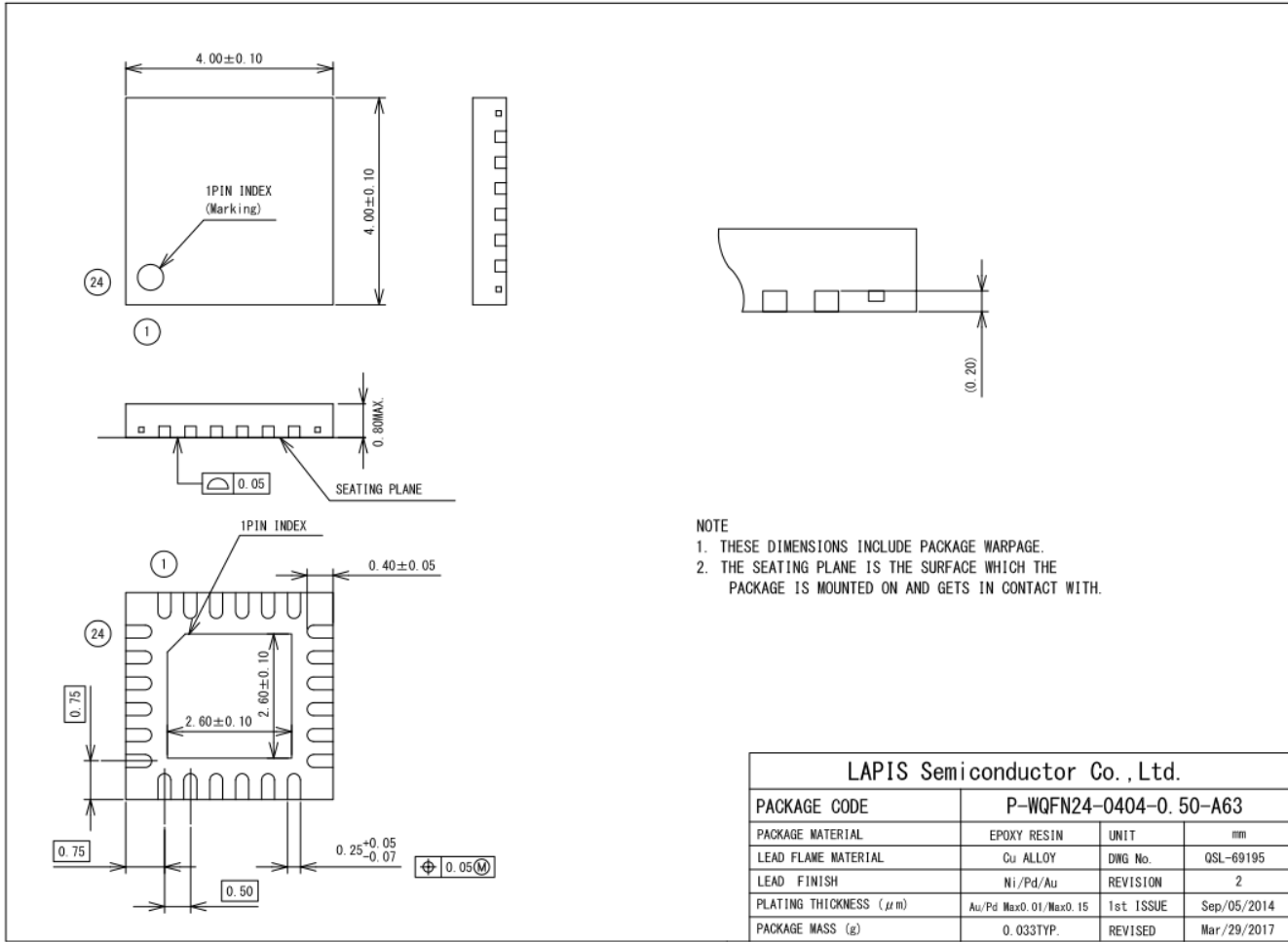

NOTE  
 1. THESE DIMENSIONS INCLUDE PACKAGE WARPAGE.  
 2. THE SEATING PLANE IS THE SURFACE WHICH THE PACKAGE IS MOUNTED ON AND GETS IN CONTACT WITH.

(Unit: mm)

Notes for Mounting the Surface Mount Type Package

The surface mount type packages are very susceptible to heat in reflow mounting and humidity absorbed in storage. Therefore, before you perform reflow mounting, contact a ROHM sales office for the product name, package name, pin number, package code and desired mounting conditions (reflow method, temperature and times).

Note for the package with exposed die pad

The die pad is exposed on the bottom of WQFN package. Make the die pad electrically open when soldering onto the PCB.

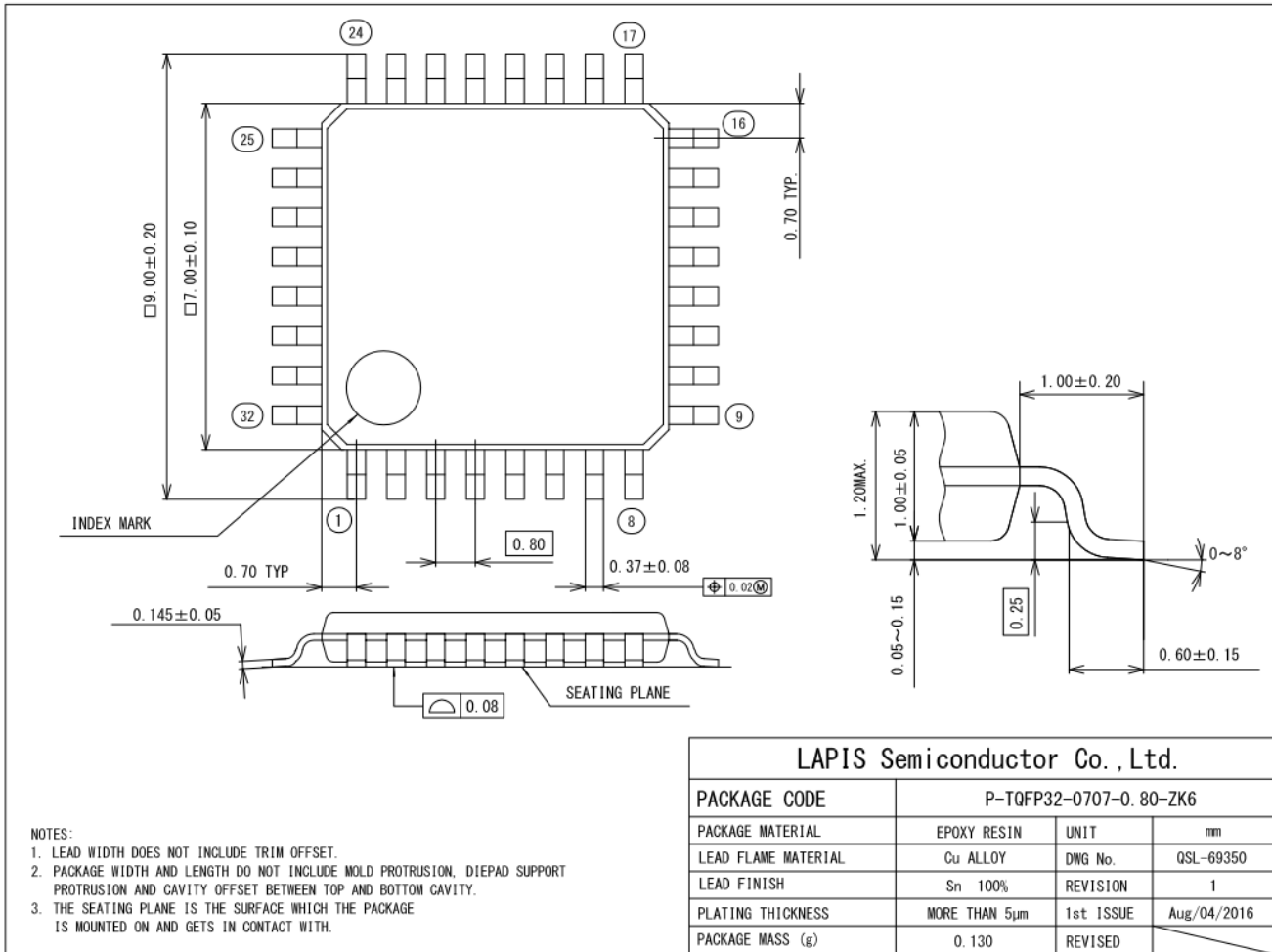

Notes for Mounting the Surface Mount Type Package

The surface mount type packages are very susceptible to heat in reflow mounting and humidity absorbed in storage. Therefore, before you perform reflow mounting, contact a ROHM sales office for the product name, package name, pin number, package code and desired mounting conditions (reflow method, temperature and times).

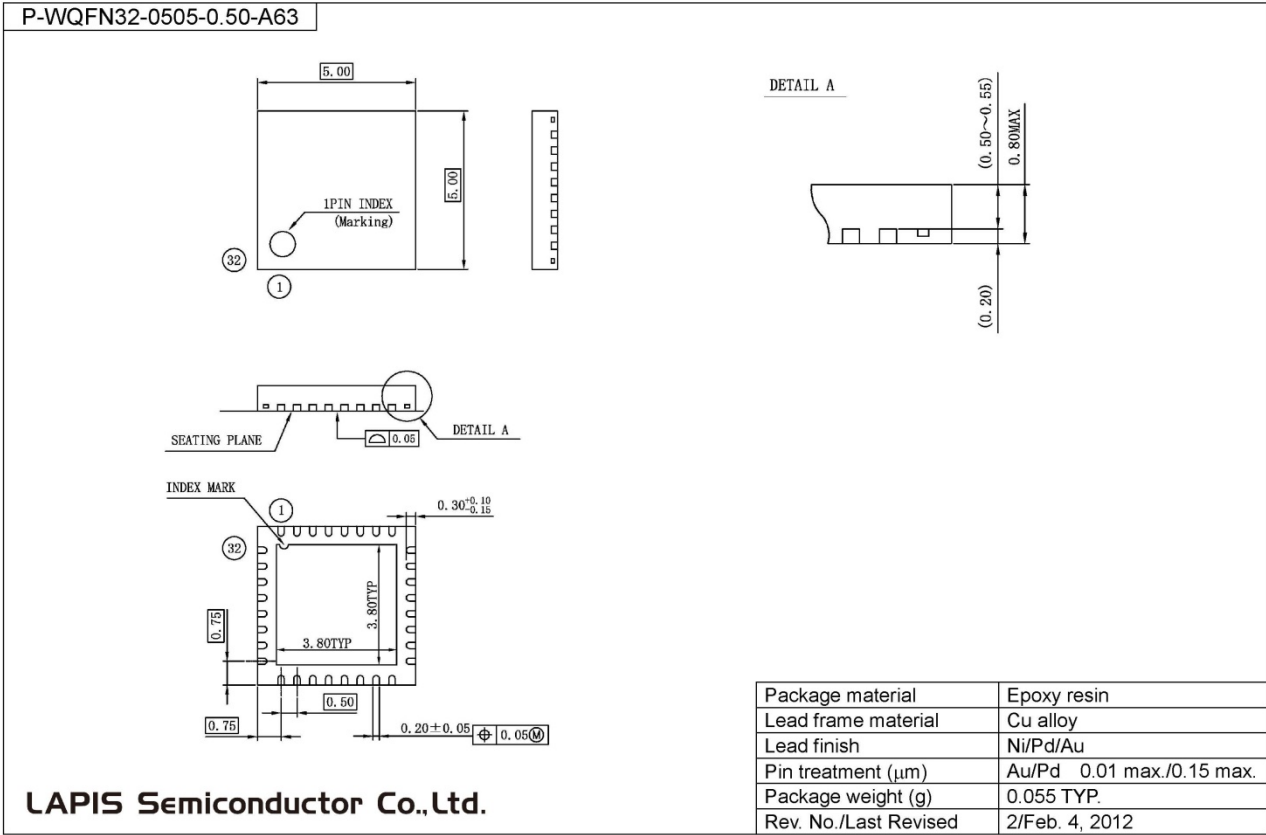

(Unit: mm)

Notes for Mounting the Surface Mount Type Package

The surface mount type packages are very susceptible to heat in reflow mounting and humidity absorbed in storage. Therefore, before you perform reflow mounting, contact a ROHM sales office for the product name, package name, pin number, package code and desired mounting conditions (reflow method, temperature and times).

Note for the package with exposed die pad

The die pad is exposed on the bottom of WQFN package. Make the die pad electrically open when soldering onto the PCB.

## REVISION HISTORY

Document No.	Date	Page		Description
		Previous Edition	Current Edition	
FEDL62Q1300-01	Nov 15, 2018	-	-	1 <sup>st</sup> Revision.
FEDL62Q1300-02	Sep 27, 2019	1	1	Changed the products status (Table 1 ML62Q1300 Group Product List)
		-	23	Added Current Consumption 1
		26	27	Added comment “*6” to the IOHL.
		46	49	Updated 24MHz Characteristics graph
		-	46,47	Added ML62Q1323/ML62Q1324/ML62Q1325/ML62Q1333/ML62Q1334/ML62Q1335 Current consumption VS operating frequency of CPU
*	*	Correction of errors		
FEDL62Q1300-03	Mar 25, 2020	21	21	Changed termination of unused pins
		22	22	Added parameter “Operating temperature(Chip-Junction)” in Recommended Operating Conditions
		—	23	Added thermal characteristics section
		34	35	Added comments and notes to the reset characteristics
		34	36	Revised overall of “Power On Reset” section as “Slope of Power supply and Power On Reset” section. The major revisions are Added definitions of Power on rising/falling slope, Power on voltage, CPU operation start time, and added Note.
*	*	Corrected typo		
FEDL62Q1300-04	Nov 15, 2020	4,8,9	4,8,9	Changed comment for UART.
		22	22	Corrected the operating temperature (Chip-Junction).

## Notes

- 1) The information contained herein is subject to change without notice.
- 2) Although LAPIS Semiconductor is continuously working to improve product reliability and quality, semiconductors can break down and malfunction due to various factors. Therefore, in order to prevent personal injury or fire arising from failure, please take safety measures such as complying with the derating characteristics, implementing redundant and fire prevention designs, and utilizing backups and fail-safe procedures. LAPIS Semiconductor shall have no responsibility for any damages arising out of the use of our Products beyond the rating specified by LAPIS Semiconductor.
- 3) Examples of application circuits, circuit constants and any other information contained herein are provided only to illustrate the standard usage and operations of the Products. The peripheral conditions must be taken into account when designing circuits for mass production.
- 4) The technical information specified herein is intended only to show the typical functions of the Products and examples of application circuits for the Products. No license, expressly or implied, is granted hereby under any intellectual property rights or other rights of LAPIS Semiconductor or any third party with respect to the information contained in this document; therefore LAPIS Semiconductor shall have no responsibility whatsoever for any dispute, concerning such rights owned by third parties, arising out of the use of such technical information.
- 5) The Products are intended for use in general electronic equipment (i.e. AV/OA devices, communication, consumer systems, gaming/entertainment sets) as well as the applications indicated in this document.
- 6) The Products specified in this document are not designed to be radiation tolerant.
- 7) For use of our Products in applications requiring a high degree of reliability (as exemplified below), please contact and consult with a LAPIS Semiconductor representative: transportation equipment (i.e. cars, ships, trains), primary communication equipment, traffic lights, fire/crime prevention, safety equipment, medical systems, servers, solar cells, and power transmission systems.
- 8) Do not use our Products in applications requiring extremely high reliability, such as aerospace equipment, nuclear power control systems, and submarine repeaters.
- 9) LAPIS Semiconductor shall have no responsibility for any damages or injury arising from non-compliance with the recommended usage conditions and specifications contained herein.
- 10) LAPIS Semiconductor has used reasonable care to ensure the accuracy of the information contained in this document. However, LAPIS Semiconductor does not warrant that such information is error-free and LAPIS Semiconductor shall have no responsibility for any damages arising from any inaccuracy or misprint of such information.
- 11) Please use the Products in accordance with any applicable environmental laws and regulations, such as the RoHS Directive. For more details, including RoHS compatibility, please contact a ROHM sales office. LAPIS Semiconductor shall have no responsibility for any damages or losses resulting non-compliance with any applicable laws or regulations.
- 12) When providing our Products and technologies contained in this document to other countries, you must abide by the procedures and provisions stipulated in all applicable export laws and regulations, including without limitation the US Export Administration Regulations and the Foreign Exchange and Foreign Trade Act.
- 13) This document, in part or in whole, may not be reprinted or reproduced without prior consent of LAPIS Semiconductor.

Copyright 2018-2020 LAPIS Semiconductor Co., Ltd.

---

## LAPIS Semiconductor Co.,Ltd.

2-4-8 Shinyokohama, Kouhoku-ku,  
Yokohama 222-8575, Japan  
<http://www.lapis-semi.com/en/>