



American Opto Plus LED Corp.

IRP4-1050C-45D

3.9 x 3.9 x 3.0mm High Power IR LED

PACKAGE OUTLINES

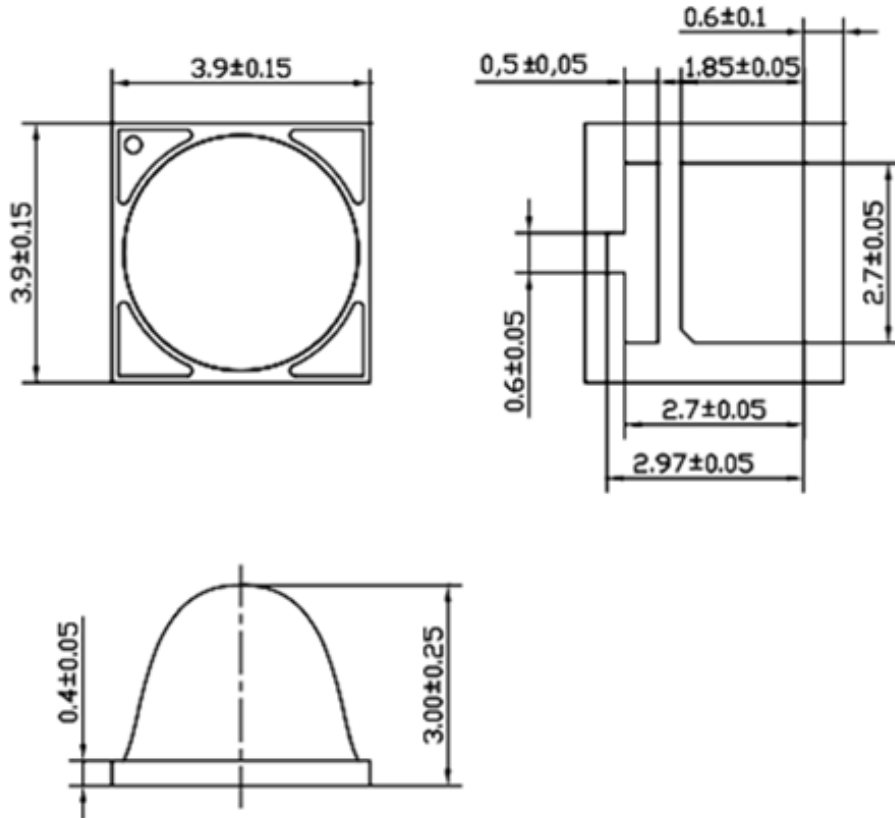

FEATURES

1. Dimension: 3.9mm(L)×3.9mm(W).
2. High Radiant Flux type.
3. All Metal Design Cu Substrate with Silicone Lens.
4. Exceed narrow beam angle 45°.
5. Ultra-low thermal resistance.
6. MSL Level: 3.

Note:

1. Units are in millimeters.



American Opto Plus LED Corp.

IRP4-1050C-45D

3.9 x 3.9 x 3.0mm High Power IR LED

PAD CONFIGURATION

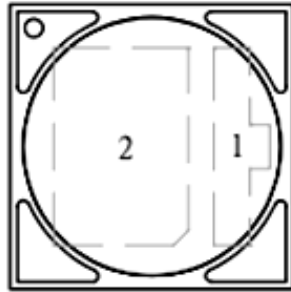

TOP

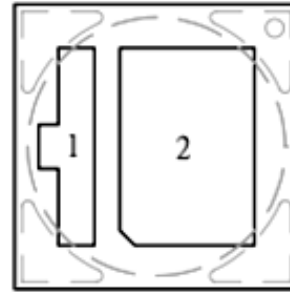

BOTTOM

Pad	Function
1	Cathode
2	Anode, Thermal

Note:

1. Please do not put conductive material on the top surface of the LEDs.



American Opto Plus LED Corp.

IRP4-1050C-45D

3.9 x 3.9 x 3.0mm High Power IR LED

ABSOLUTE MAXIMUM RATINGS

T_j=25°C

Parameter	Symbol	Rating	Unit
Power Dissipation	P	2.5	W
Forward Current	I _F	1000	mA
Reverse Voltage	V _R	5	V
LED Junction Temperature	T _j	125	°C
Operating Temp. Range	T _{opr}	-40°C~+85°C	
Storage Temp. Range	T _{stg}	-40°C~+120°C	
Soldering Condition	T _{sol}	260°C for 10 sec.	

ELECTRICAL/OPTICAL CHARACTERISTICS

T_j=25°C

Parameter	Symbol	Min	Typ	Max	Test Condition	Unit
Peak Wavelength	λ _p	1000	1050	1100	IF=1000mA	nm
Radiant Flux	Φ _e	500	700	--		mW
Radiant Intensity	I _e	--	600	--		mW/Sr
Forward Voltage	V _F	1.2	1.4	1.8		V
Spectral Half-Width	Δλ	--	50	--		nm
Beam Angle	2θ ½	--	45	--		deg
Temp. Coefficient of Brightness	TC _I	--	-0.2	--	--	%/K
Temp. Coefficient of Voltage	TC _v	--	-1	--	--	mV/K
Temp. Coefficient of Wavelength	TC _λ	--	0.3	--	--	nm/K
Thermal Resistance, Junction Case	R _{th, J-C1}	--	5	--	--	°C/W

The thermal resistance value is measured with MCPCB (star).



American Opto Plus LED Corp.

IRP4-1050C-45D

3.9 x 3.9 x 3.0mm High Power IR LED

BIN CODE LIST

T_j=25°C

Item	Bin Code	Symbol	Condition	Min	Max	Unit
Forward Voltage	9	VF	IF=1000mA	1.11	1.35	V
	A			1.35	1.59	
	B			1.59	1.83	
Radiant Flux	F	Φ _e		500	600	mW
	G			600	700	
	H			700	800	

Forward voltage measurement allowance is $\pm 0.1V$.

Radiant flux measurement allowance is $\pm 10\%$.



American Opto Plus LED Corp.

IRP4-1050C-45D

3.9 x 3.9 x 3.0mm High Power IR LED

CHARACTERISTIC DIAGRAMS

Forward Current vs. Forward Voltage

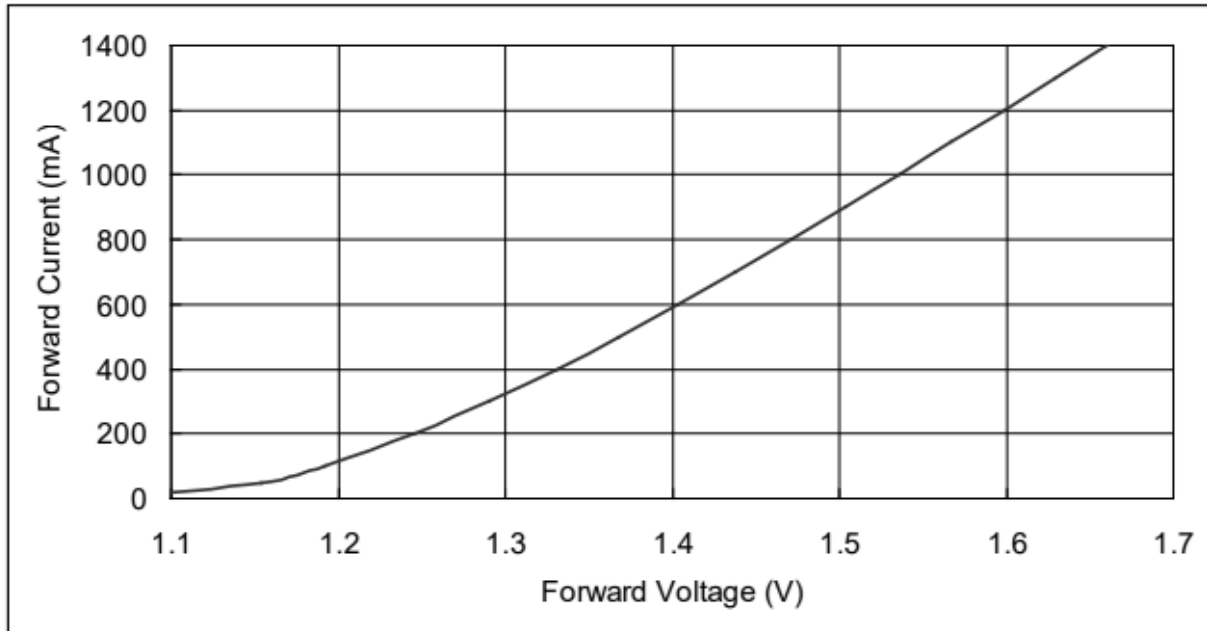

Relative Intensity vs. Forward Current

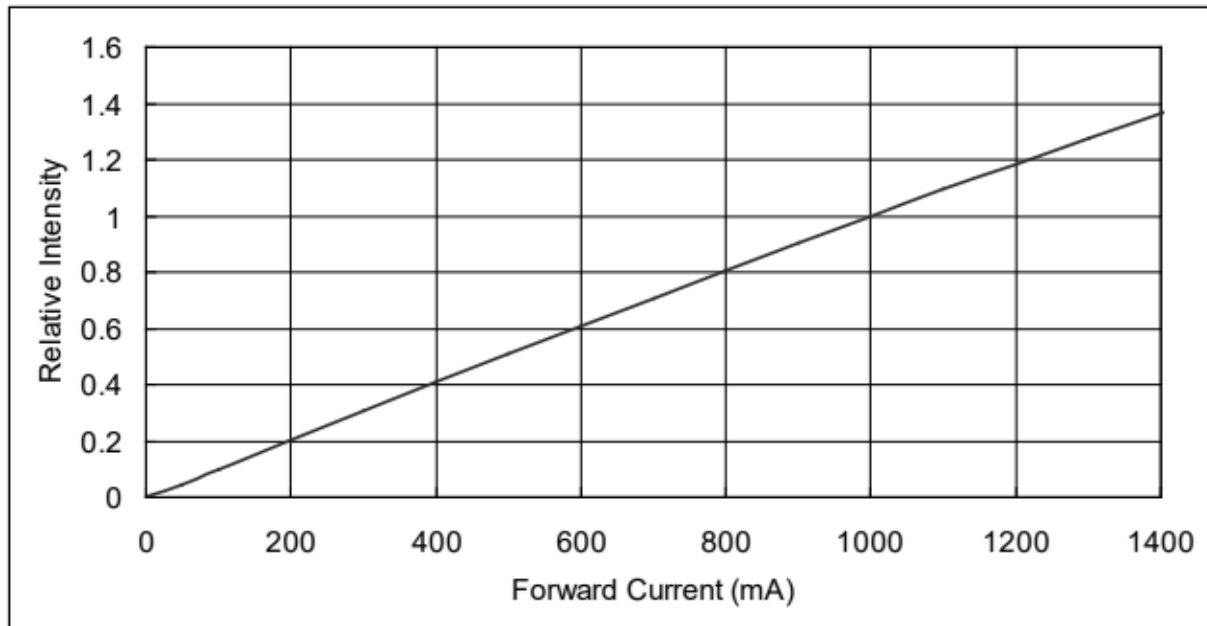



American Opto Plus LED Corp.

IRP4-1050C-45D

3.9 x 3.9 x 3.0mm High Power IR LED

CHARACTERISTIC DIAGRAMS

Typical Relative Intensity vs. wavelength

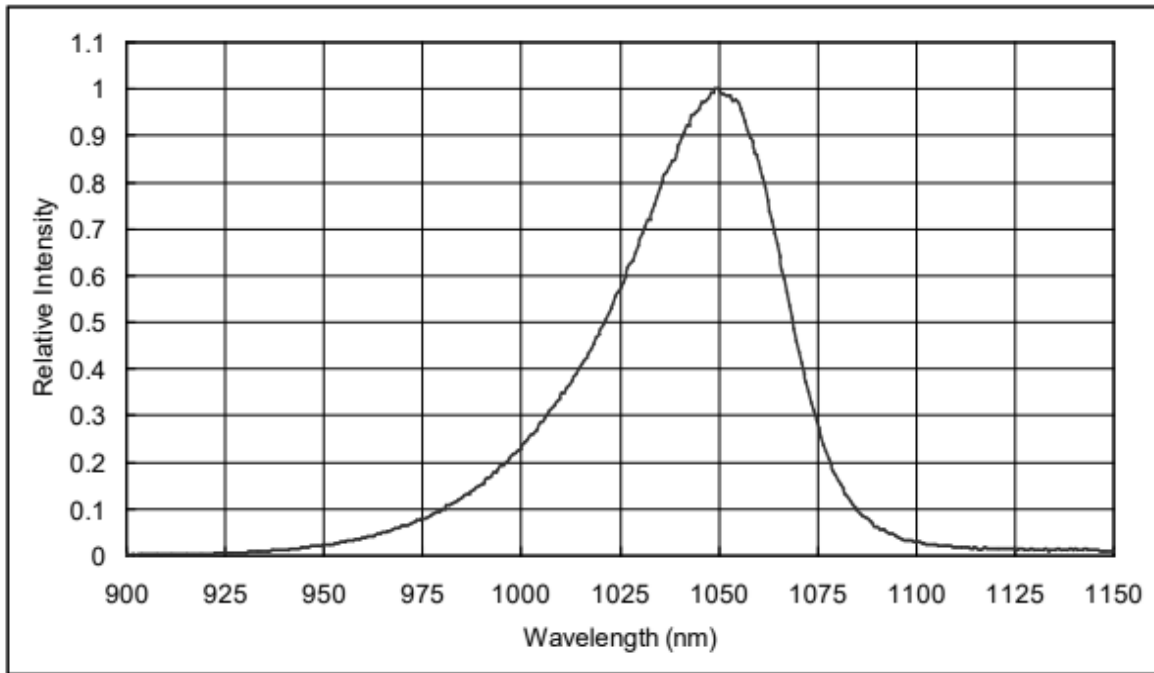

Typical Representative Spatial Radiation Pattern

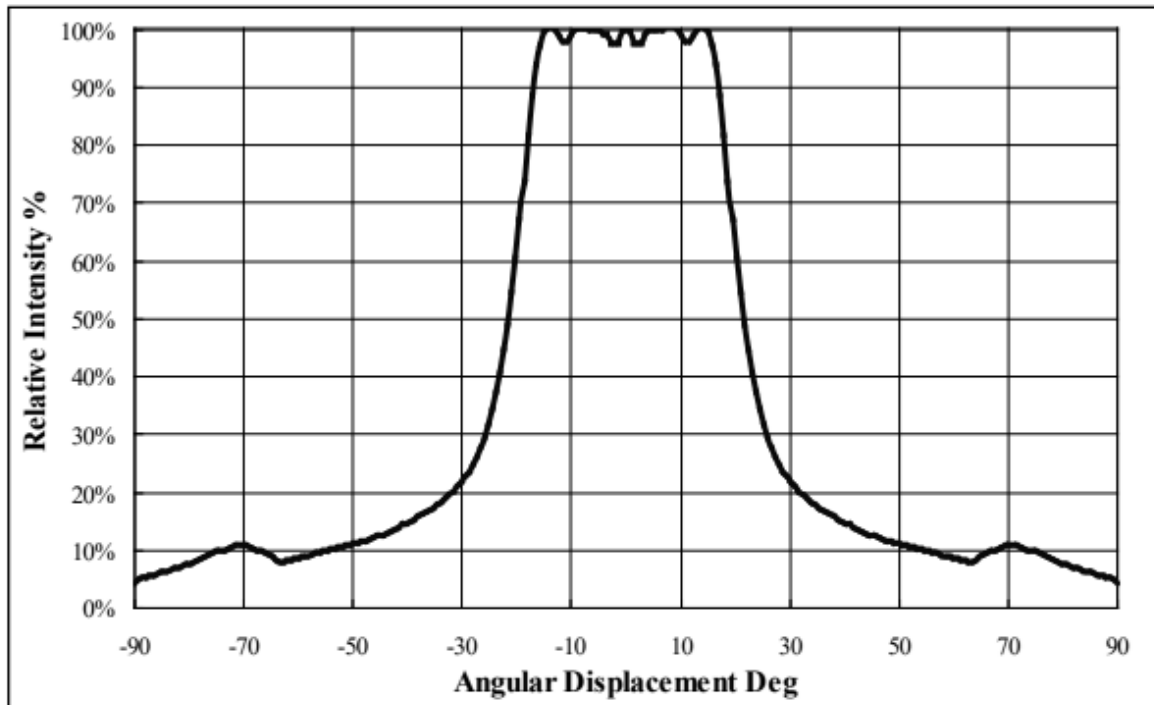



American Opto Plus LED Corp.

IRP4-1050C-45D

3.9 x 3.9 x 3.0mm High Power IR LED

CHARACTERISTIC DIAGRAM

Permissible pulse handling capability at $T_j=85^\circ\text{C}$ for various duty cycles (D)

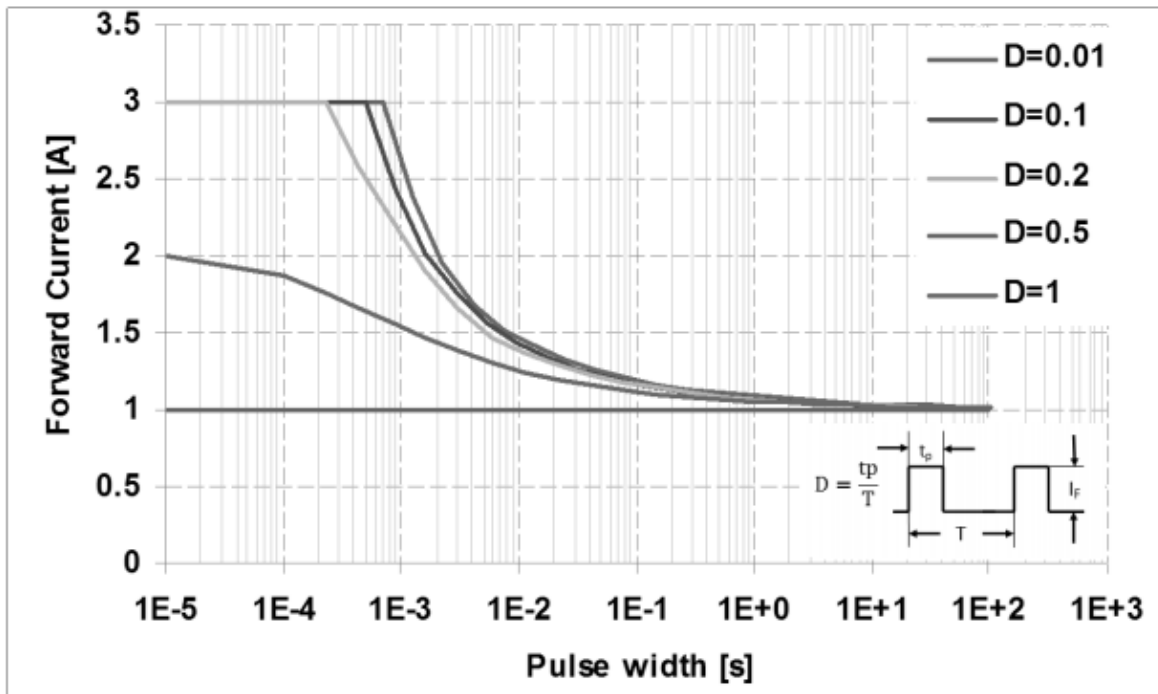



American Opto Plus LED Corp.

IRP4-1050C-45D

3.9 x 3.9 x 3.0mm High Power IR LED

PACKAGING SPECIFICATIONS

Taping Dimensions

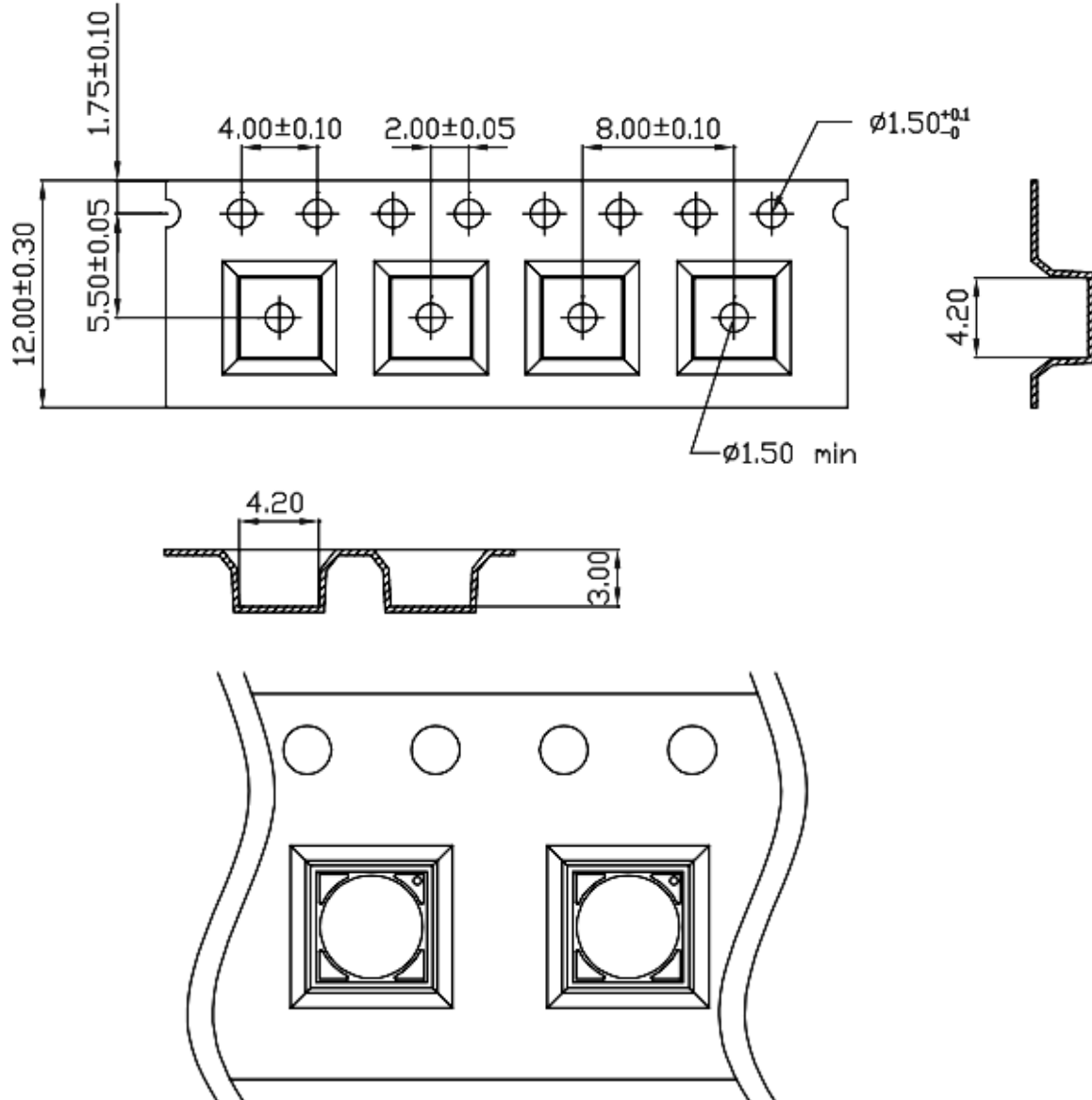

Note:

1. 1 Reel/bag.
2. 2500pcs/reel.
3. Units are in millimeters.
4. Moisture proof bag.

Version 1.1 Date: 05/19/2021 Specifications are subject to change without notice.

American Opto Plus LED Corp. 1206 E. Lexington Ave., Pomona CA 91766 Tel: 909-465-0080 Fax: 909-465-0130 www.aopled.com



American Opto Plus LED Corp.

IRP4-1050C-45D

3.9 x 3.9 x 3.0mm High Power IR LED

PACKAGING SPECIFICATIONS

Reel Dimensions (Unit: mm)

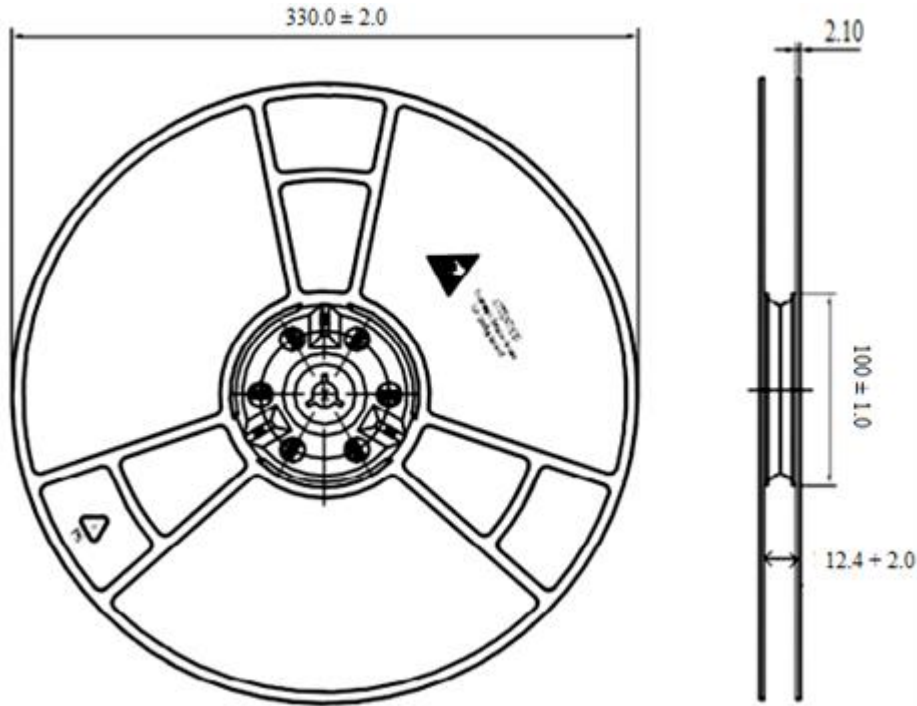

Anti-Statistic Bag (Unit: mm)

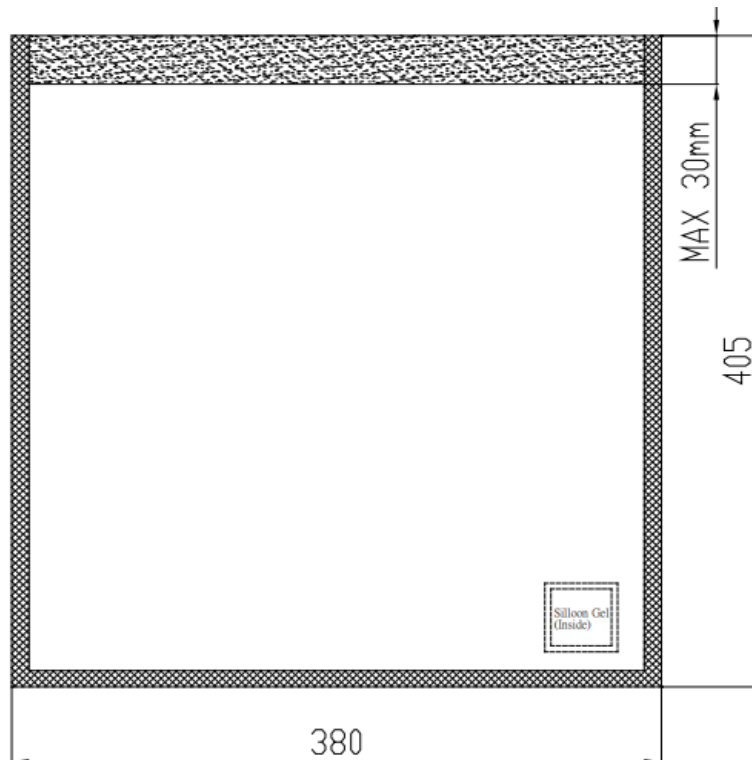

Version 1.1 Date:

American Opto Plus LED Corp. 1206 E. Lexington Ave., Pomona CA 91766 Tel: 909-465-0080 Fax: 909-465-0130 www.aopled.com



American Opto Plus LED Corp.

IRP4-1050C-45D

3.9 x 3.9 x 3.0mm High Power IR LED

QUALIFICATION RELIABILITY TEST

Classification	Test Item	Test Conditions	Reference Standard
Endurance Test	Operation Life	IF = 1000mA Ta = 25°C Test Duration = 1000hrs	MIL – STD – 750: 1026 MIL – STD – 883: 1005 JIS C 7021: B-1
	High Temp. High Humidity Storage	Ta = 85 ± 5°C RH = 85 ± 5% Test Duration = 1000hrs	MIL – STD – 202: 103B JIS C 7021: B-11
	High Temperature Storage	Ta = 105 ± 5°C Test Duration = 1000hrs	MIL – STD – 202: 1008 JIS C 7021: B-10
	Low Temperature Storage	Ta = -40 ± 5°C Test Duration = 1000hrs	JISC 7021: B-12
Environmental Test	Temperature Cycling	-30°C ~ 25°C ~ 105°C ~ 25°C 30min – 5min – 30min – 5 min Test Duration = 10 cycles	MIL-STD-202: 107D MIL-STD-750: 1051 MIL-STD-883: 1010 JIS C 7021: A-4
	Thermal Shock	-30 ± 5°C ~ 105 ± 5°C 30min ~ 30min Test Duration = 10 cycles	MIL-STD-202: 107D MIL-STD-750: 1051 MIL-STD-883: 1011
	Solder Resistance	Tsol = 260 ± 5°C Dwell Time: 10	MIL-STD-202: 210A MIL-STD-750: 2031



American Opto Plus LED Corp.

IRP4-1050C-45D

3.9 x 3.9 x 3.0mm High Power IR LED

		sec	JIS C 7021: A-1
--	--	-----	-----------------

RELIABILITY TESTING

Measuring Items	Symbol	Measuring Conditions	Failure Criteria
Forward Voltage	V _F	I _F =1000mA	V _F shift > 10%
Luminous	I _v %	I _F =1000mA	I _v % shift > 10%



American Opto Plus LED Corp.

IRP4-1050C-45D

3.9 x 3.9 x 3.0mm High Power IR LED

RECOMMENDED SOLDER PROFILE

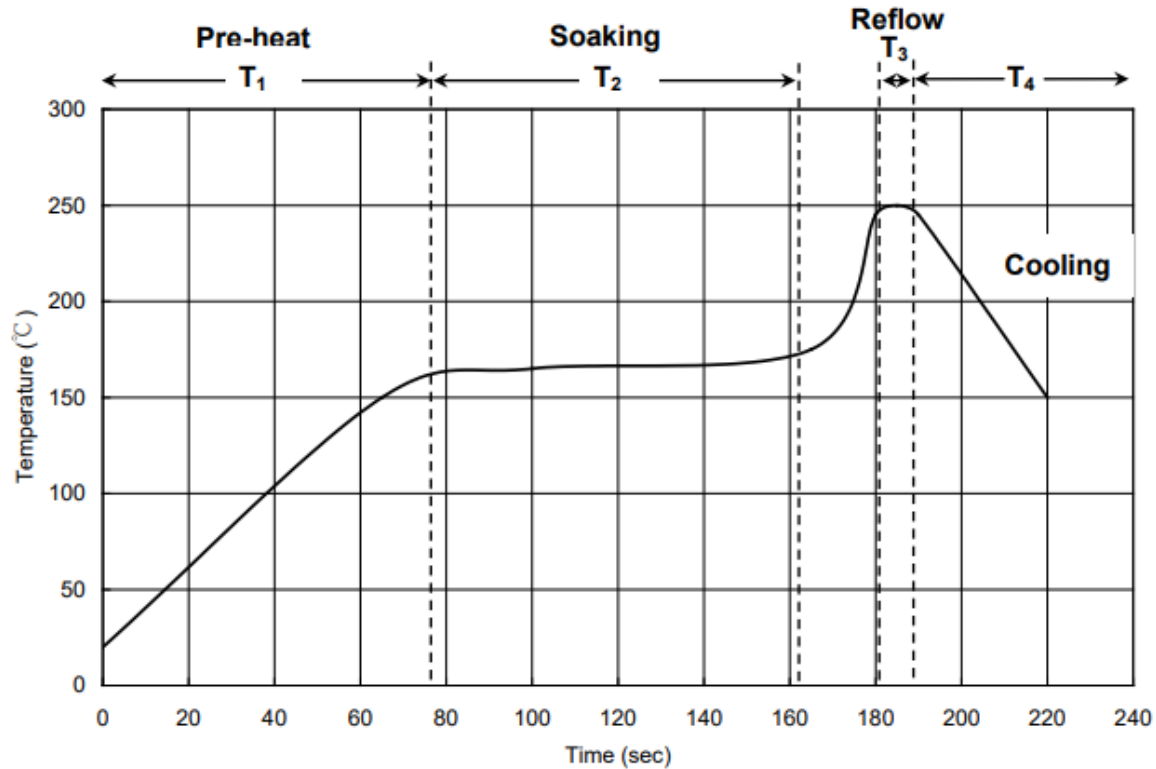

	Parameter	Values
T1	Ramp Up Rate	1.0 ~ 3.0 °C/sec
	Pre-heat Time	50 ~ 80 sec
T2	Soaking Temperature	155 ~ 185 °C
	Dwell Time During Soaking	60 ~ 120 sec
T3	Reflow Temperature	240 ~ 250 °C
	Reflow Time	Max 10 sec
	Ramp Up Rate During Reflow	1.2 ~ 2.3 °C/sec
T4	Cooling	1.0 ~ 6.0 °C/sec

Suggest using Sn96Ag3Cu 0.5 lead free solder.

Cleaning: Use alcohol – based cleaning solvents such as isopropyl alcohol to clean the LED if necessary.



American Opto Plus LED Corp.

IRP4-1050C-45D

3.9 x 3.9 x 3.0mm High Power IR LED

RECOMMENDED SOLDER PAD PATTERN

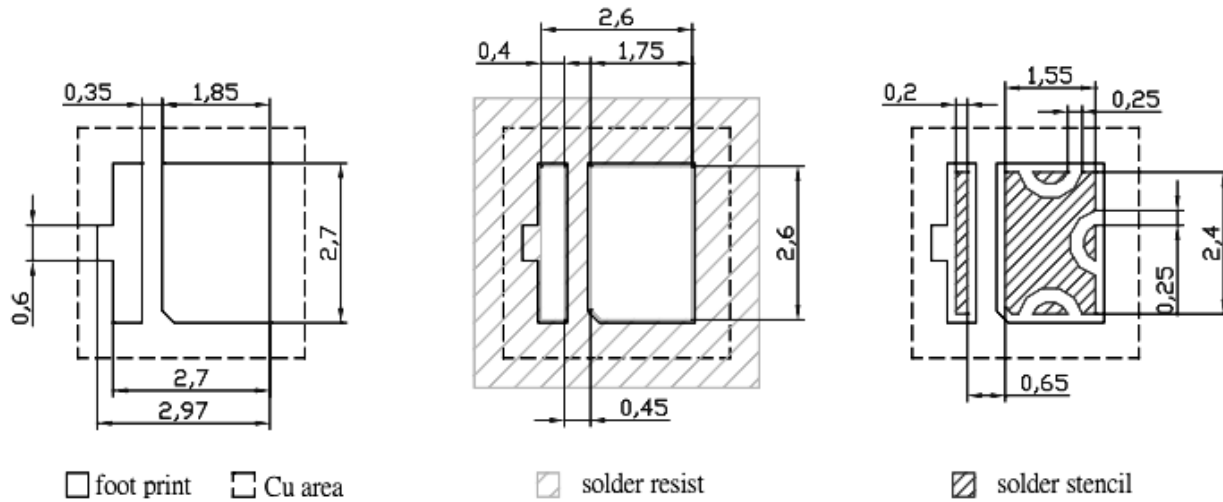

Note:

1. Units are in millimeters.
2. Tolerances are ± 0.05 .



American Opto Plus LED Corp.

IRP4-1050C-45D

3.9 x 3.9 x 3.0mm High Power IR LED

HANDLING PRECAUTIONS



Do not poke the Led Lens
with sharp object



Do not stack
assembled PCB



Do not hold the Led
with hand



Do not press or push
the Led Lens

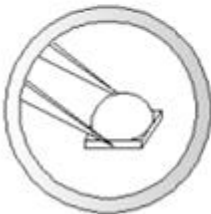

Hold the Led only by
the substrate

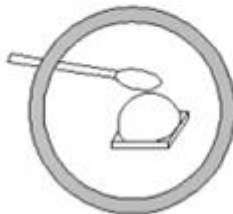

Clean the LED surface
with cotton bud



Use pick and place nozzle per
recommendation in data sheet