

UDP UPPI CARD USER'S GUIDE

1. Introduction

The UPPI-series evaluation cards are the engine of an MCU-based system, containing an MCU, optional radio, and minimal support circuitry.

These cards are designed around either a C8051F96xMCU or a Si102x/3x Wireless MCU. Only placement-critical items, such as bypass capacitors, crystals, dc-dc inductor, and RF front end circuitry are included. All other circuits reside on the hosting platform.

These cards are compatible with Silicon Labs Unified Development Platform MCU cards (UDP-F960-MCU series). They may also be used as prototyping modules, as they fit on a 2 mm-center prototyping board.

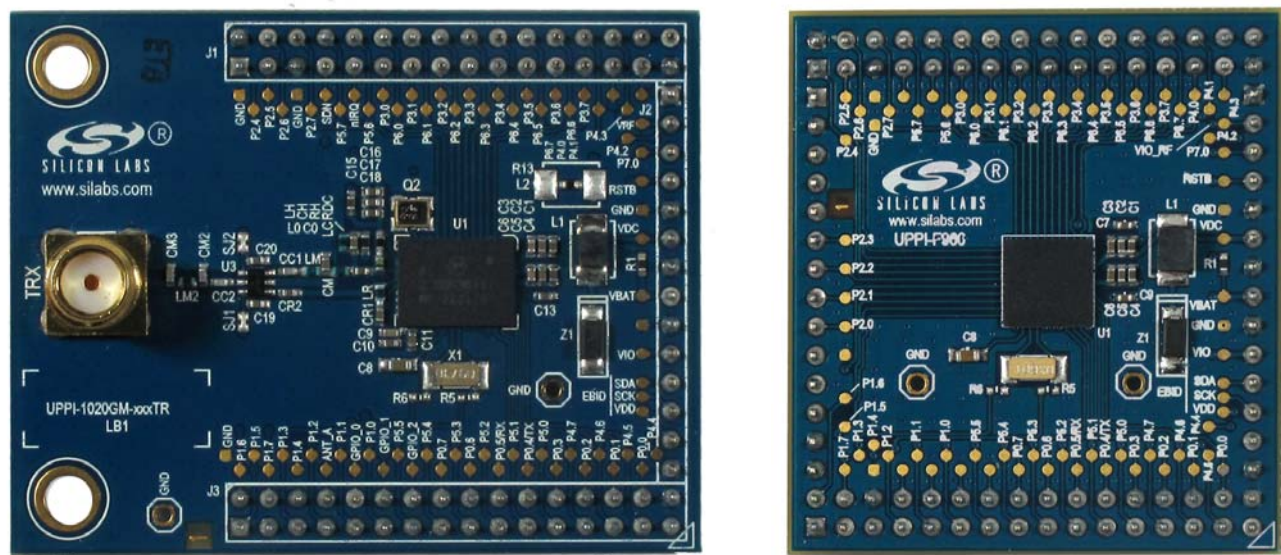

Figure 1. UPPI Cards with and without Radio

UDP UPPI Card UG

2. Description

The UPPI cards contain the MCU device and a minimal number of supporting components. Most of the core device pins are connected directly to headers, allowing signal mapping to be defined by the host board, typically a UDP MCU card. (See “2.3. Compatibility” for more information.)

Each board design varies in schematic and features. Refer to the board design files available from www.silabs.com for specifics.

2.1. Features

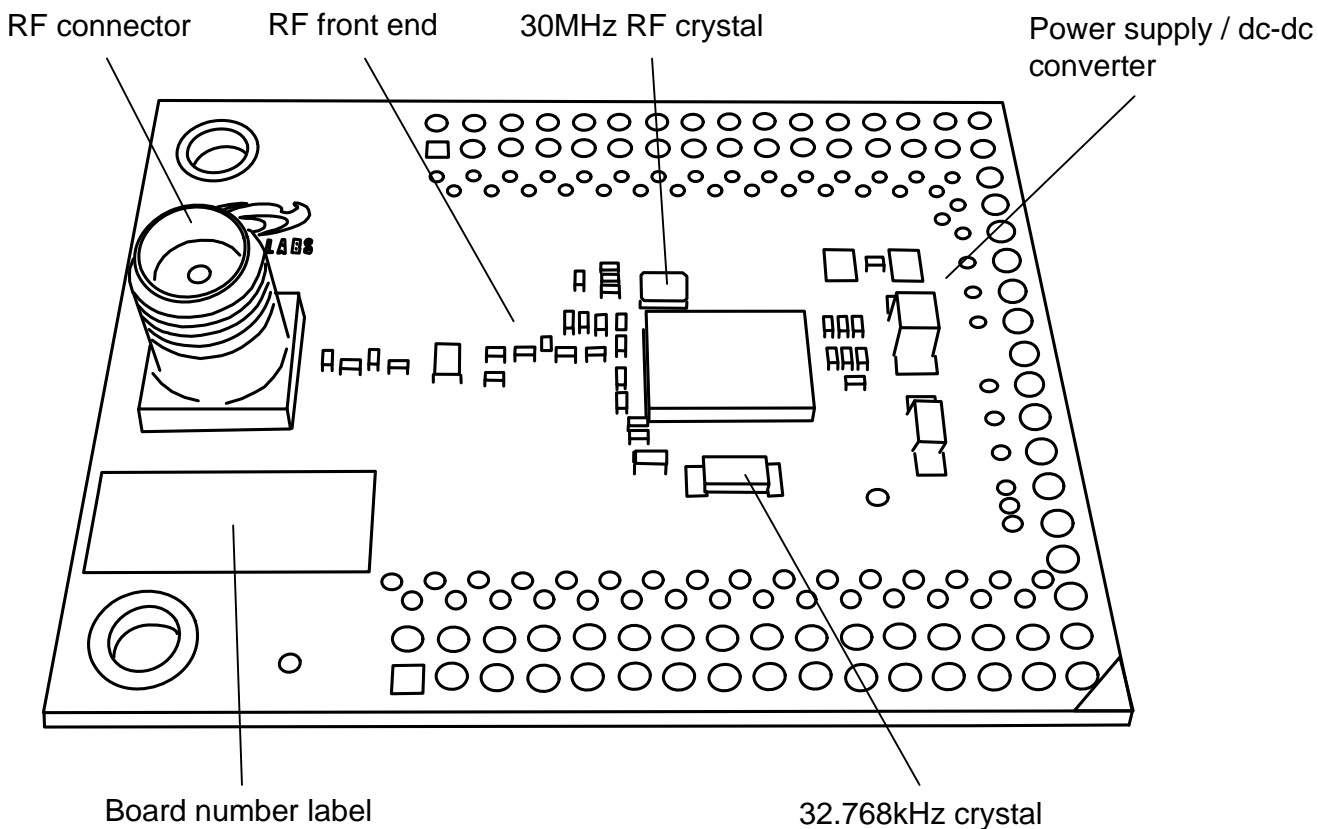

Figure 2. Top View: UPPI-10xx-fffTR and UPPI-10xx-fffDT Wireless MCU Boards

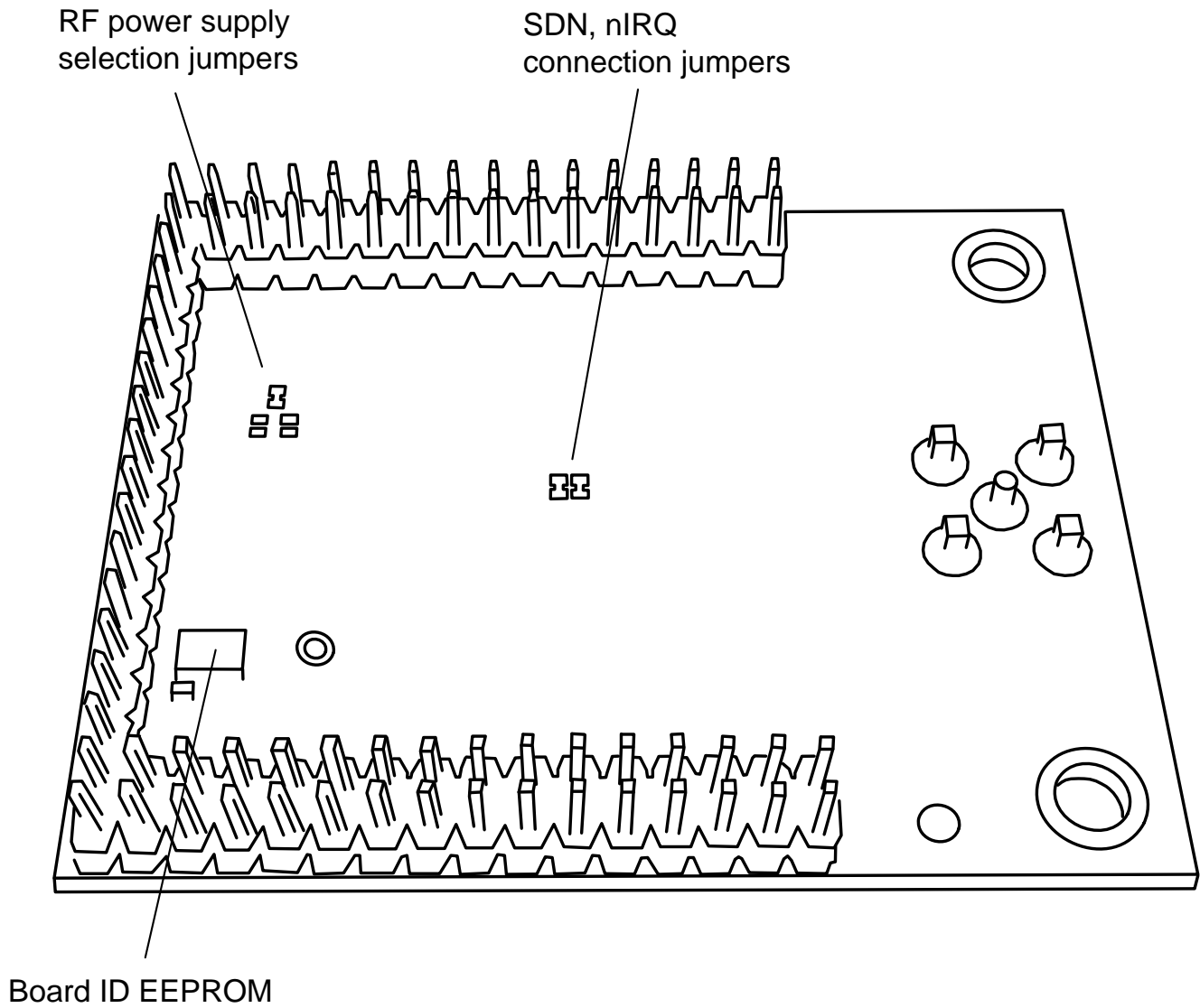

Figure 3. Bottom View: UPPI-10xx-fffTR and UPPI-10xx-fffDT Wireless MCU Boards

UDP UPPI Card UG

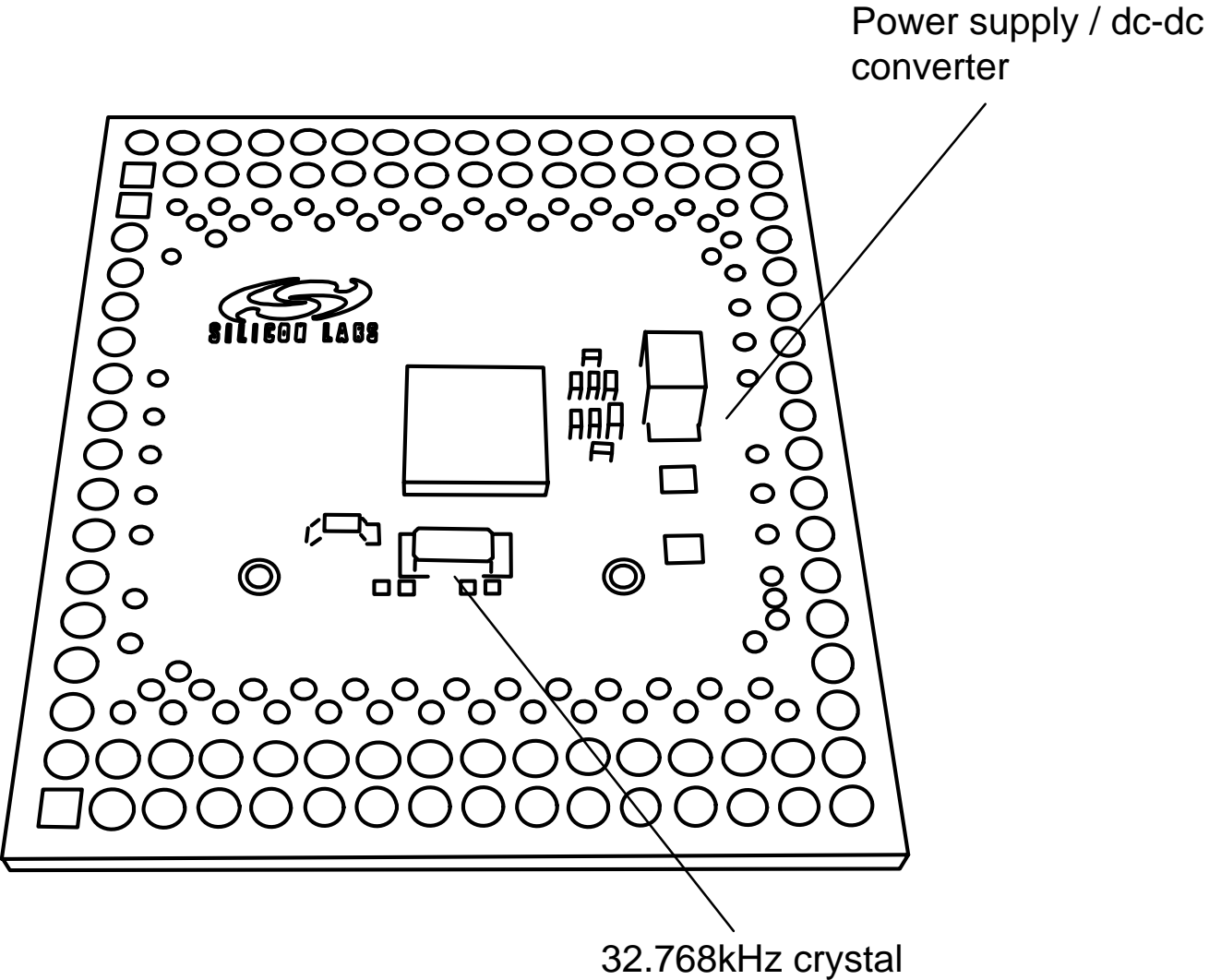
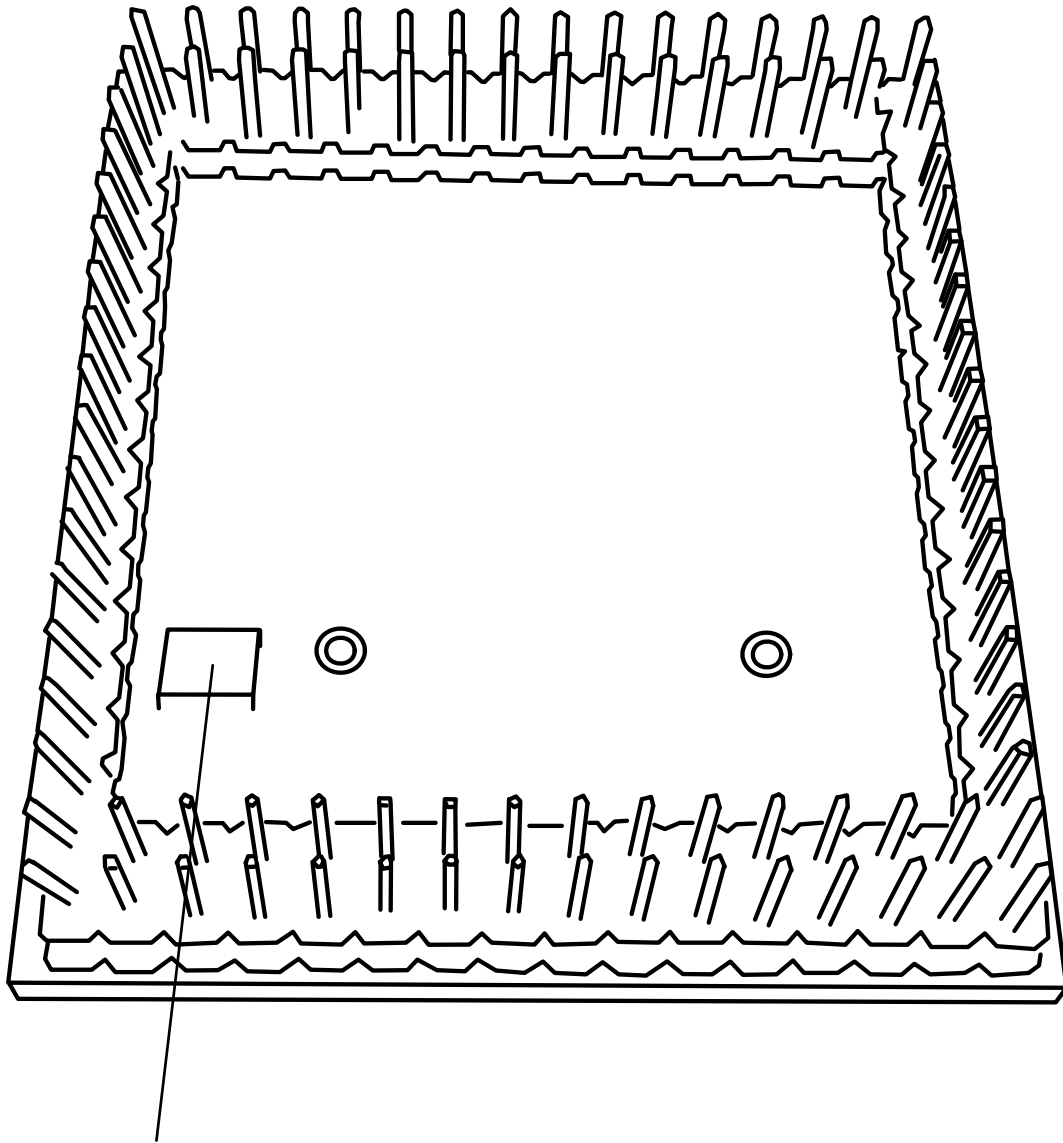

Figure 4. Top View: UPPI-F960



Board ID EEPROM

Figure 5. Bottom View: UPPI-F960

UDP UPPI Card UG

The UPPI cards contain the following functions:

■ Power Supply

The device's VBAT and VDC pins are connected to external pins. The dc-dc inductor, optional diode, and bypass capacitors are all included on the UPPI board as recommended in the data sheet.

The VIO connection is routed to a pin and must be connected on the host board.

The VIO_RF pin (if applicable) is connected to the VRF net and routed to a pin. This net supplies both the radio section power and the VIO_RF I/O voltage. The source is set on the host board, but may be optionally hard-wired via solder jumpers on the back of the board.

■ Crystal Oscillators

The MCU has a 32.768kHz crystal connected to the XTAL 3/4 pins. Devices with a radio have a 30 MHz crystal connected to the radio's XOUT/XIN pins. These nets are not connected to pins.

■ RF Front End

All RF matching circuitry is on-board. The transmitter and receiver pins are both matched to a 50 Ω SMA connector. This connector may be used with test equipment or an appropriate antenna.

The matching is based on either a T/R switch or a Direct Tie topology. The T/R switch topology uses a TX/RX switch device to share the RF port between TX and RX paths. T/R is used with high power (+20dBm) devices. The Direct Tie topology passively sums TX and RX paths and is suitable for low-power (+13dBm) devices.

Both matching topologies are discussed in detail in the following application notes:

- AN427: EZRadioPRO™ Si433X & Si443X RX LNA Matching (+20dBm, T/R switch)
- AN435: Si4032/4432 PA Matching (+20 dBm, T/R switch)
- AN436: Si4030/4031/4430/4431 PA Matching (+13 dBm, Direct Tie)

■ RF GPIO Signals

The radio's GPIO_0 - GPIO_2 and ANT_A nets are connected to pins. GPIO_1 and GPIO_2 are also connected on-board to the RF transmit/receive switch on high power ("TR" version) boards.

■ RF to MCU Interface Signals

The radio and MCU are interconnected within the Si102x/3x device. Two external signals, shutdown (SDN) and the interrupt (nIRQ) are connected to MCU port pins on the board. These signals may be disconnected by cutting jumpers on the back of the board.

■ Port Pins

Most port pins are connected directly to the module's pins. Exceptions include

- Pins dedicated to the on-board radio interface
- P1.2 / P1.3, as these pins are used for the 32.768kHz crystal. These may be connected by adding 0-ohm resistors.

■ Programming/Debugging

C2CK/RSTB and C2D are connected to the module header. C2CK/RSTB has an on-board pullup resistor to VBAT.

■ Unified Development Platform Support

An EEPROM is included on the back side of the board to identify board information to the UDP system.

This EEPROM is electrically isolated from the rest of the board except for a common ground.

The UPPI boards are based on 2mm-center headers. The footprint fits any C8051F96x- or Si102x/3x compatible Unified Development Platform MCU card. The UPPI boards may also be used for prototyping, using a 2mm-center perforated prototyping board.

The UPPI boards should be fastened to the base board using two 4-40 screws and 6.5mm standoffs to resist twisting moments from the antenna or RF cabling.

2.2. Ordering Information

A variety of UPPI boards are available, each tailored to a specific RF frequency band, transmitter power, and RF front end configuration. Refer to www.silabs.com for specific ordering information.

Table 1. Ordering Information

	Device	Description	Frequency	Tx Power (Max)	Rf Front End
MCU Only					
UPPI-F960	C8051F960	'F960 microcontroller only	—	—	—
Wireless MCU					
UPPI-1020-fffTR	Si1020	Si1020 Wireless MCU with T/R switch (+20 dBm)	fff MHz	+20 dBm max	T/R switch
UPPI-1024-fffDT	Si1024	Si1023 Wireless MCU with Direct Tie RF front end (+13 dBm)	fff MHz	+13 dBm max	Direct Tie
*Note: refer to www.silabs.com for an up to date list of supported frequency variants					

2.3. Compatibility

These boards are compatible with the following UDP MCU cards:

- UDP F960 MCU card with Multiplexed LCD (UPMP-F960-MLCD)
- UDP F960 MCU card with EMIF (UPMP-F960-EMIF)

UDP UPPI Card UG

2.4. Schematics

These schematics show circuit topologies of the various cards. Refer to the latest schematics, available from www.silabs.com, for actual values.

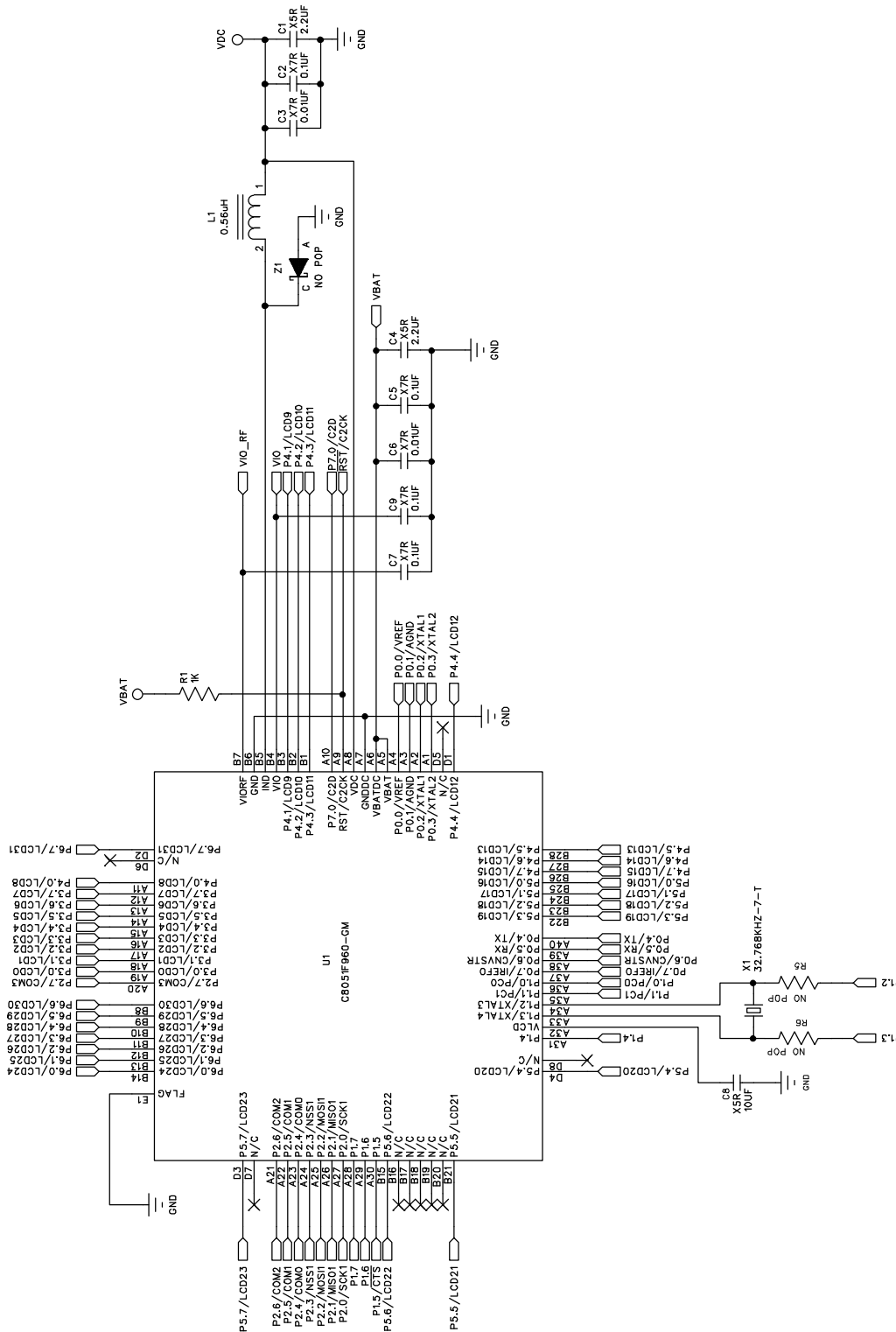

Figure 6. UPPI-F960 (1 of 2)

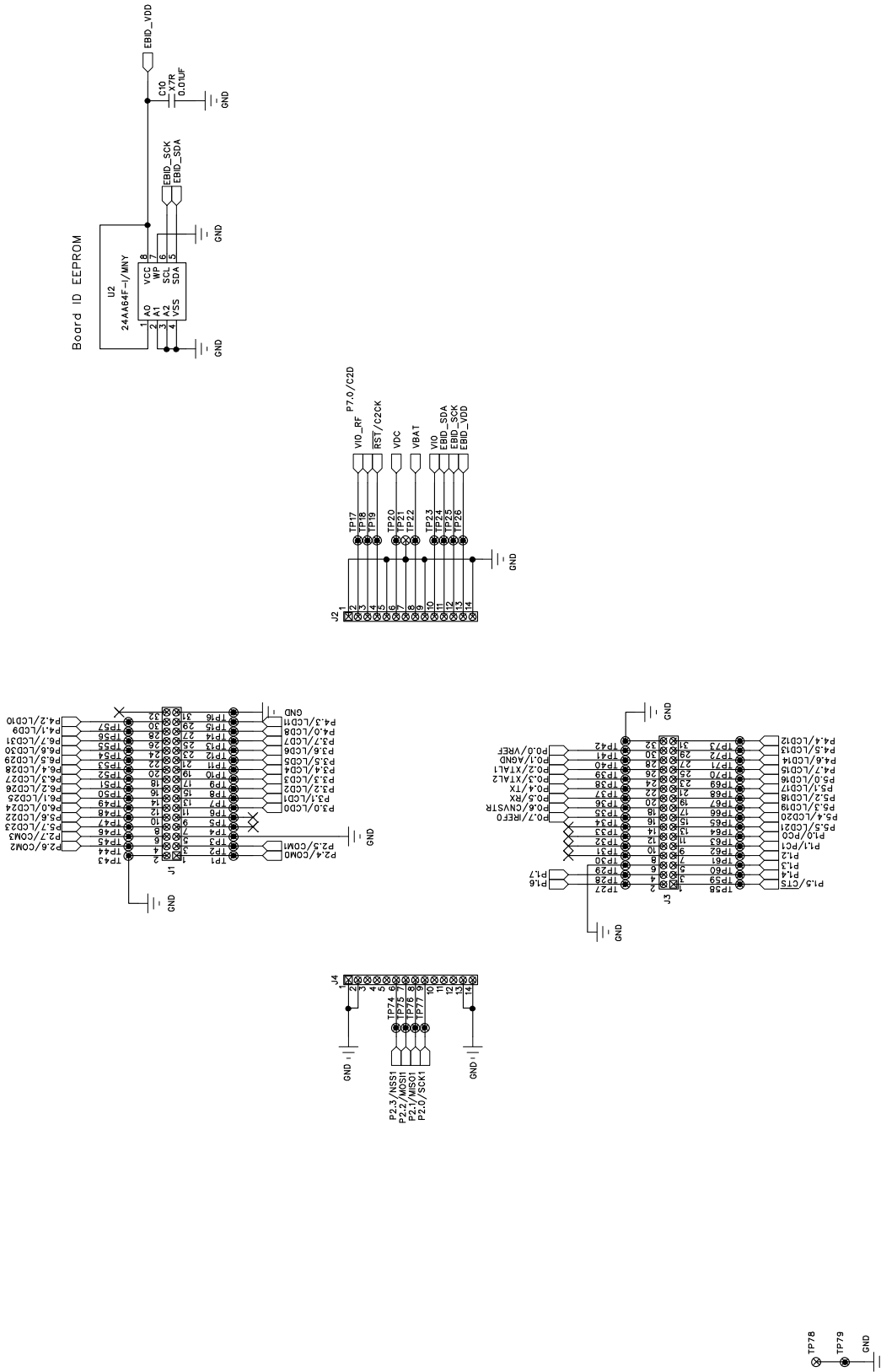

Figure 7. UPPI-F960 (2 of 2)

UDP UPPI Card UG

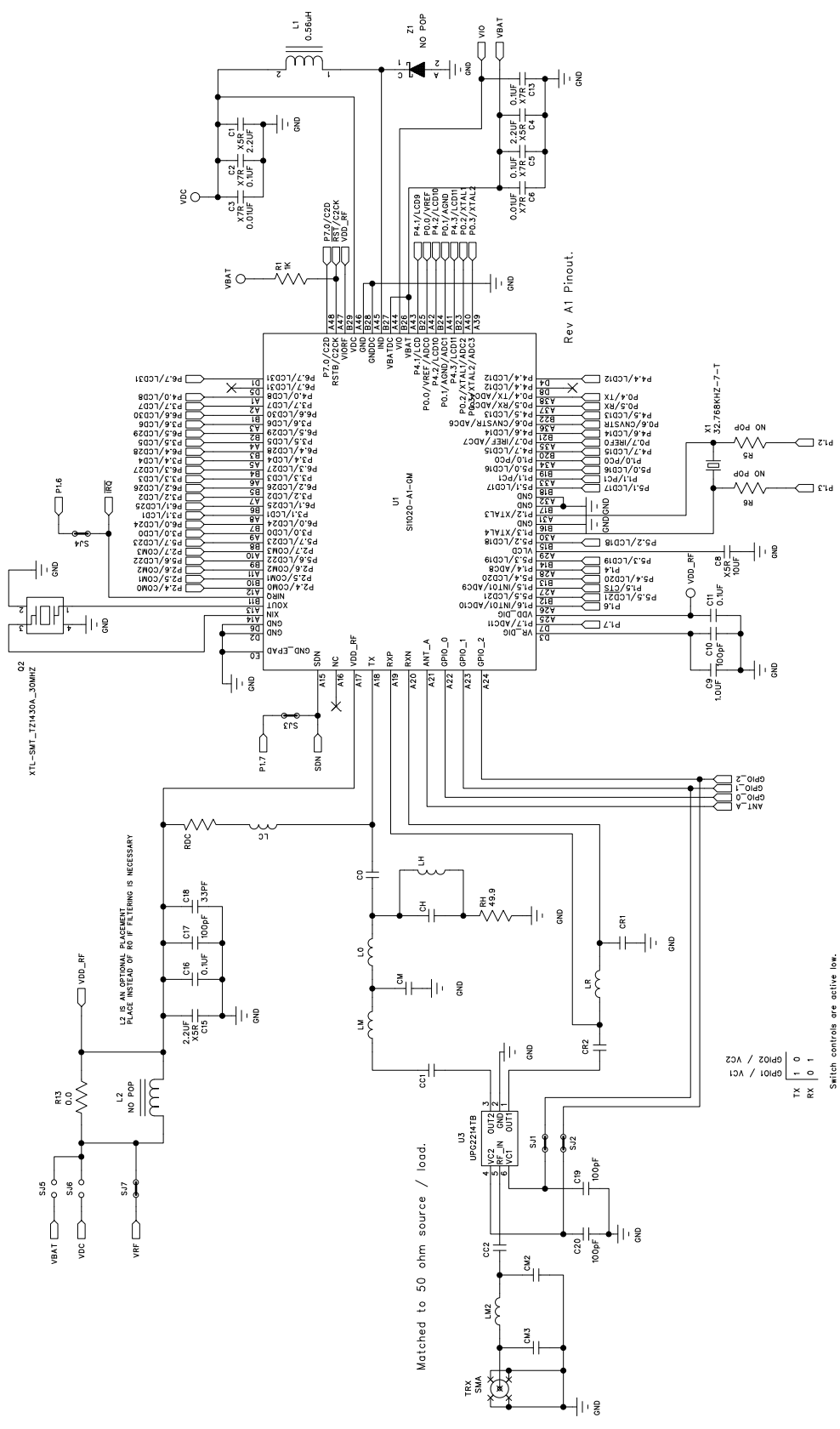

Figure 8. UPPI-1020-ffTR (1 of 2)

Switch controls are active low.

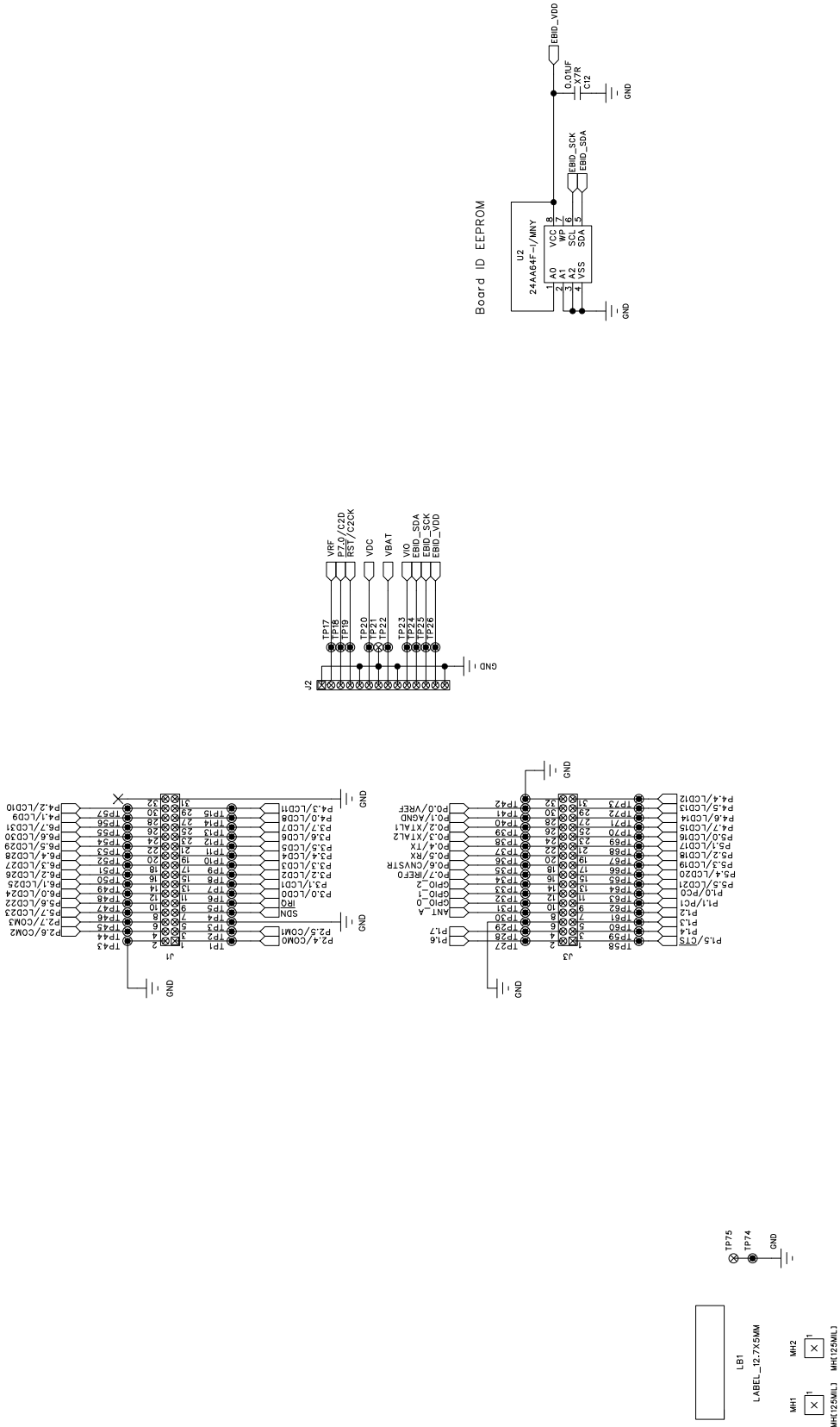
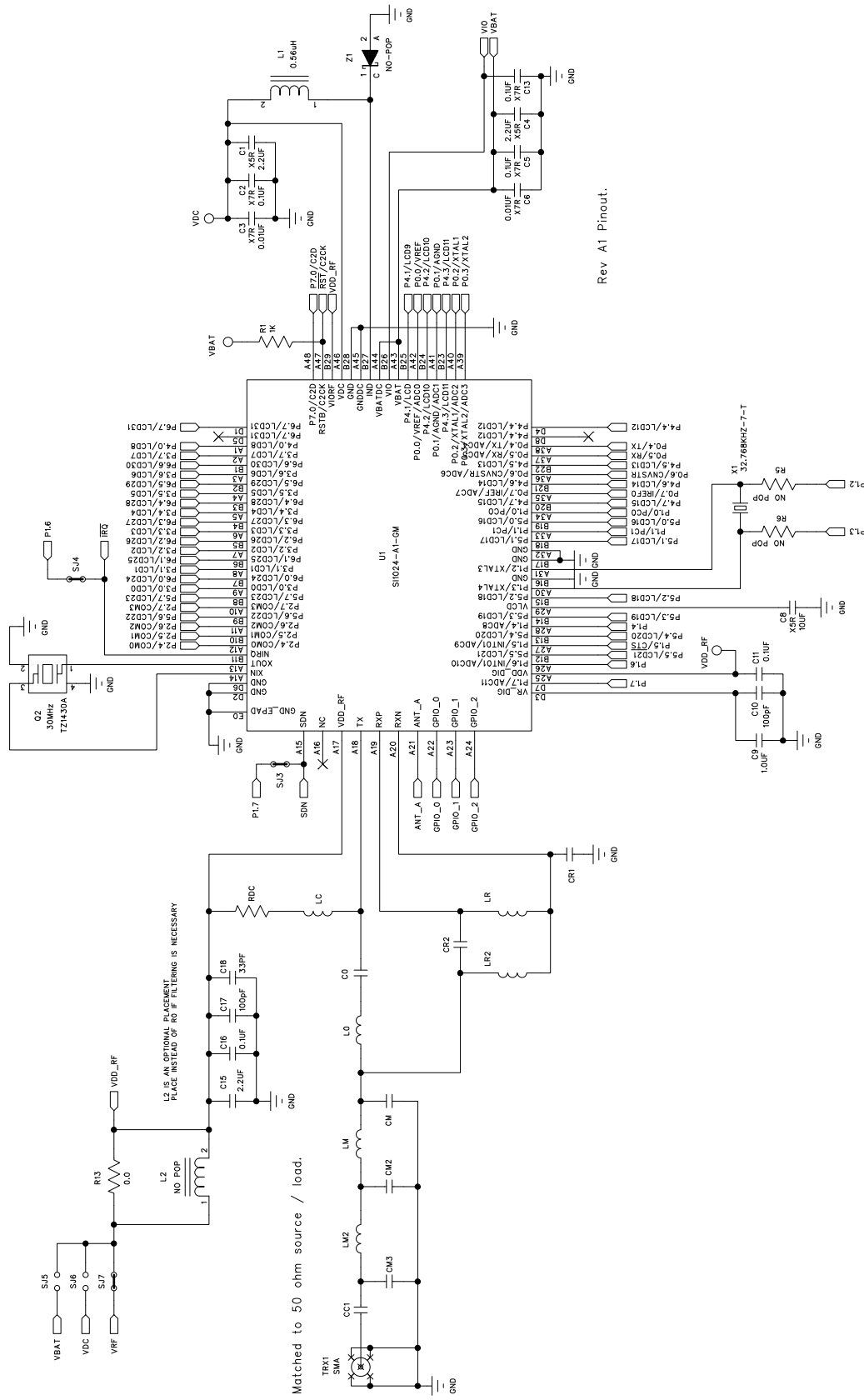

Figure 9. UPPI-1020-fffTR (2 of 2)

UDP UPPI Card UG



Rev A1 Pinout.

Figure 10. UPPI-1024-ffDT (1 of 2)

UDP UPPI Card UG

2.5. PCB Layouts

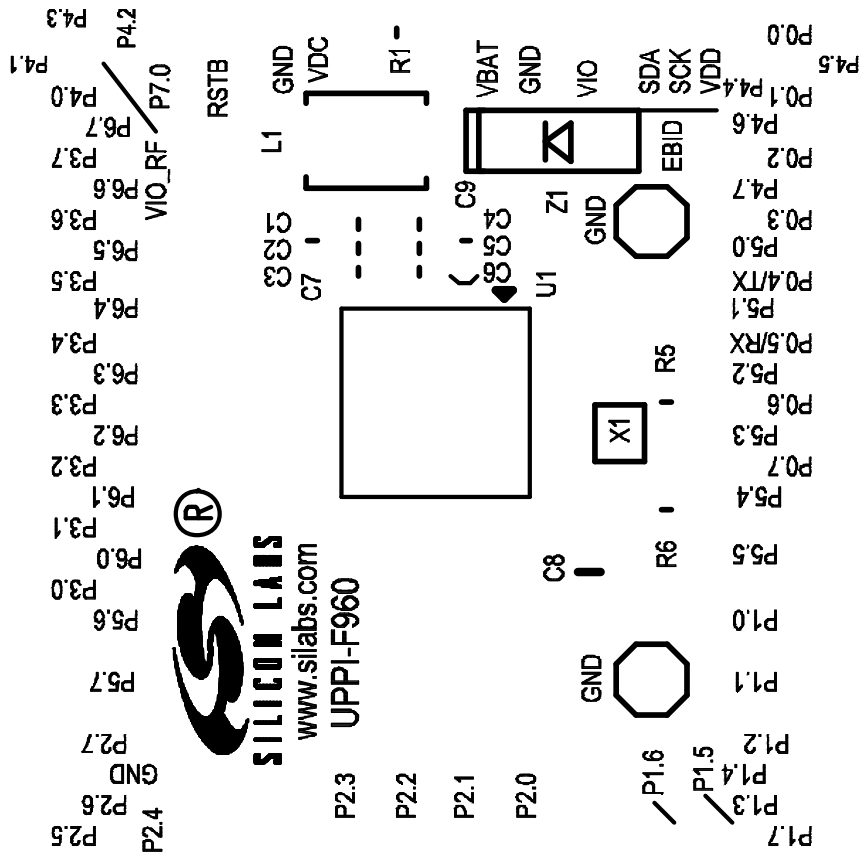

Figure 12. UPPI-F960 Silkscreen Top

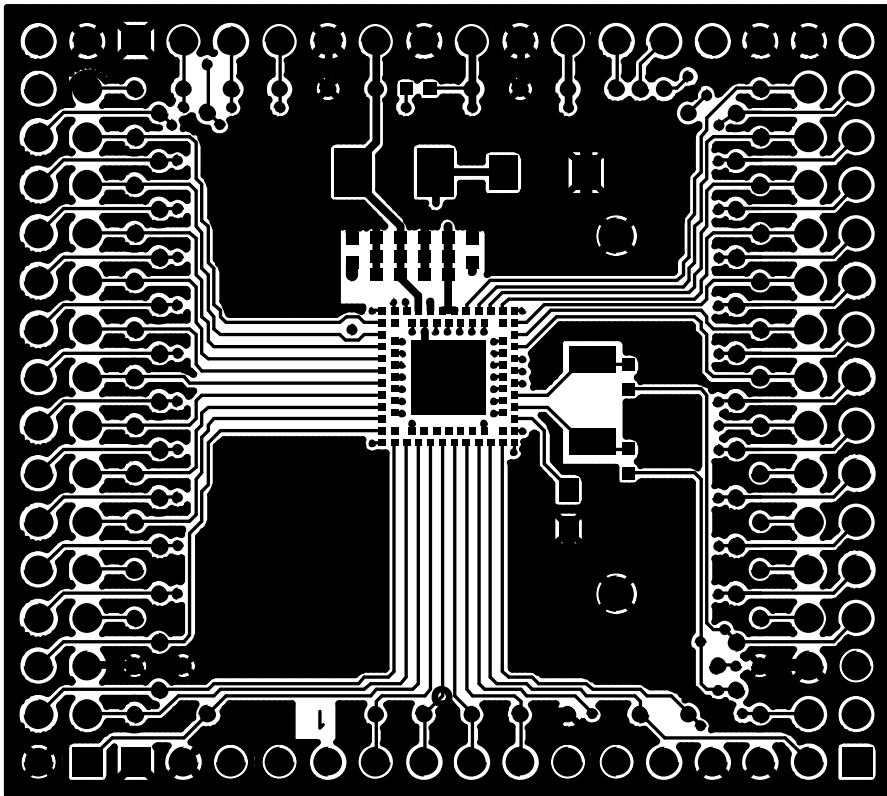

Figure 13. UPPI-F960 Top Side

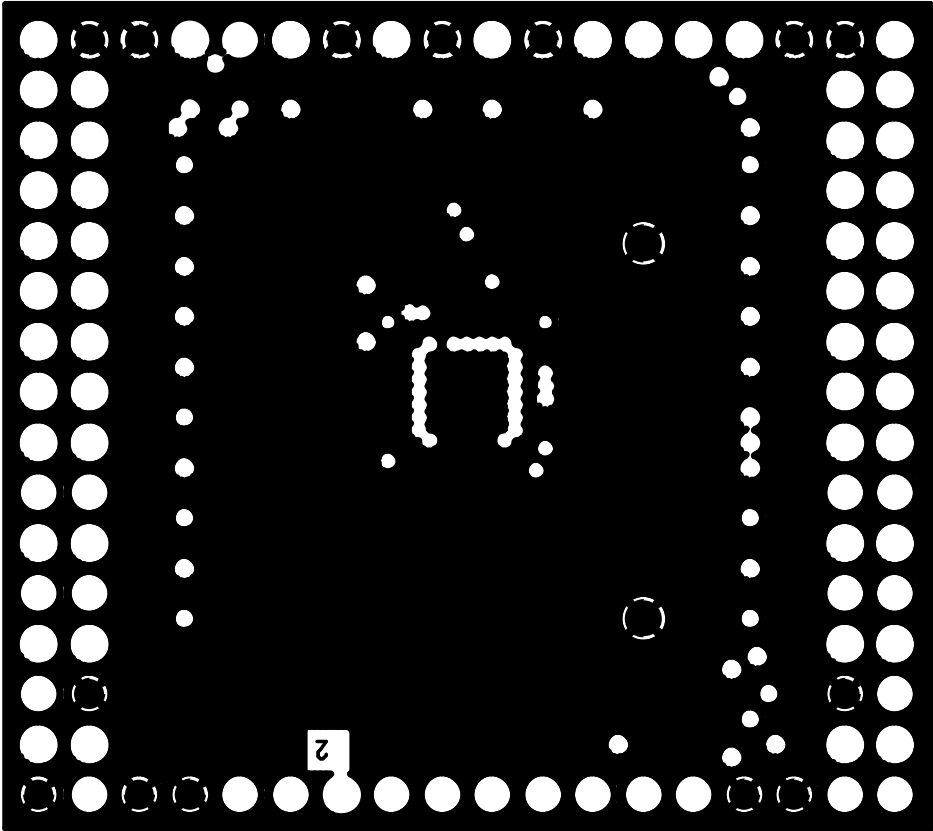

Figure 14. UPPI-F960 Layer 2

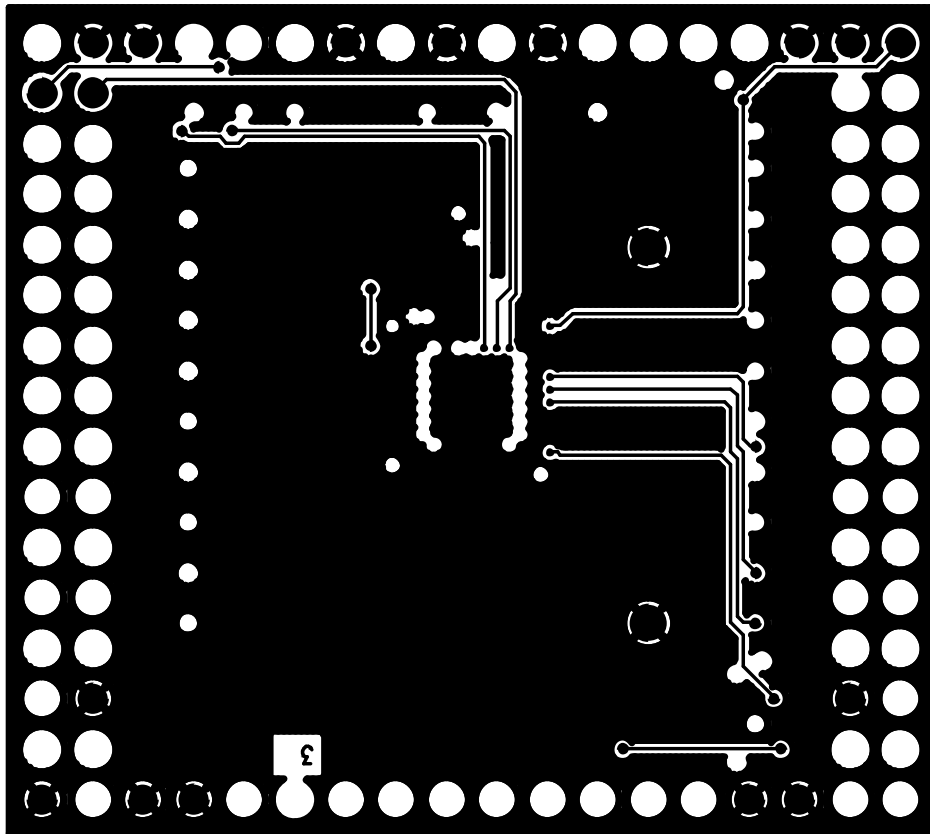

Figure 15. UPPI-F960 Layer 3

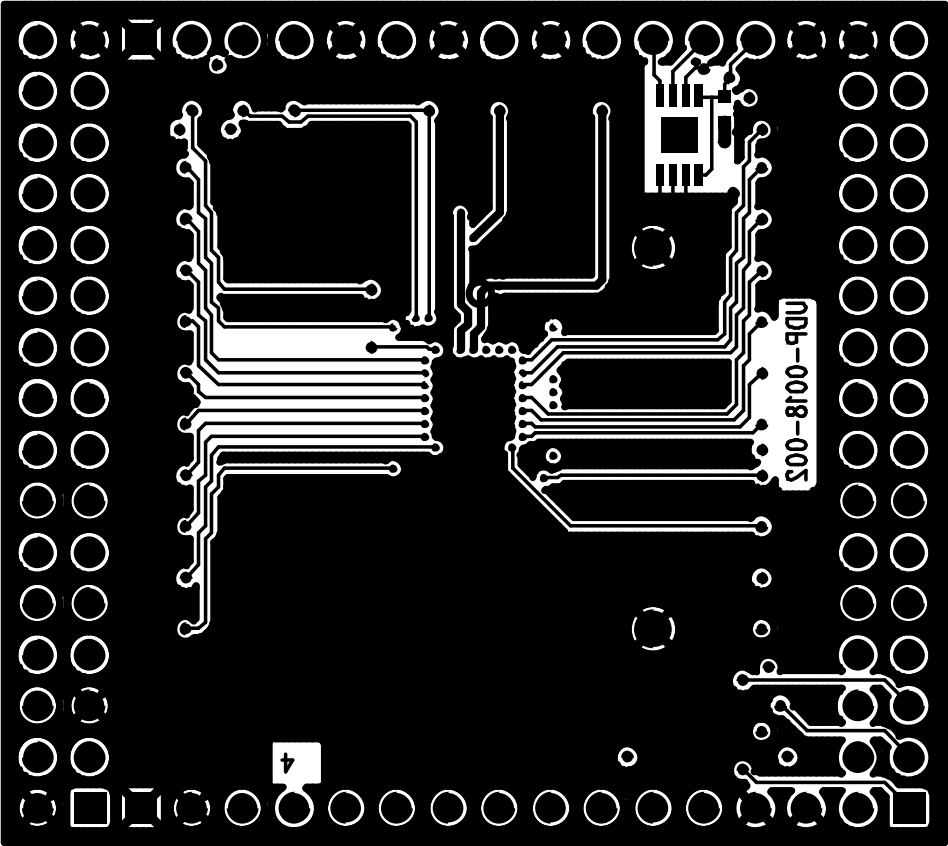
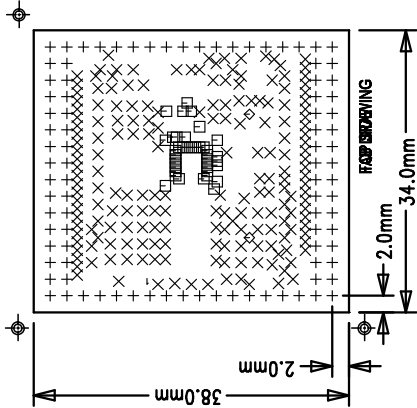

Figure 16. UPPI-F960 Bottom Side

NOTES : UNLESS OTHERWISE SPECIFIED

1. MANUFACTURE IN ACCORDANCE WITH IPC-6012, TYPE 3, CLASS 2.
2. END PRODUCT FEATURES SHALL NOT VARY MORE THAN 20% FROM ARTWORK ORIGINALS.
3. LAMINATE AND PREPREG SHALL BE AS PER IPC-4101/26,83,98 WITH A DECOMPOSITION TEMPERATURE \geq 345°C, COLOR, NATURAL.
4. COPPER WEIGHT SHALL BE 1.0 OZ./SQ. FT. BEFORE PLATING, UNLESS OTHERWISE SPECIFIED.
5. ALL PLATED THROUGH HOLES SHALL HAVE A MINIMUM OF 0.001" COPPER.
6. DRILL HOLE TOLERANCE AFTER PLATING SHALL BE \pm 0.003".
7. MINIMUM ANNULAR RING SHALL BE 0.001".
8. MINIMUM ANNULAR RING AT EMERGENT CONDUCTORS SHALL BE 0.003".
9. FINAL PCB THICKNESS SHALL BE 0.062" \pm 10% ACROSS PADS.
10. WARP/TWIST SHALL NOT EXCEED 0.010 INCH PER INCH.
11. FINISH SHALL BE LPI, BLUE S.M.O.B.C., BOTH SIDES.
12. SILKSCREEN WITH NONCONDUCTIVE WHITE EPOXY INK.
13. NO VENDOR MARKINGS OR ALTERATIONS SHALL BE PERMITTED ON ANY METAL OR SILKSCREEN LAYERS.
14. BOARD STACKUP:
 - TOP LAYER PLATED TO 1 OZ
 - PREPREG FR4: 12 MILS \pm 1 MIL
 - L2-GND 1 OZ Cu
 - PREPREG FR4: 28 MILS
 - L3-POWER 1 OZ Cu
 - PREPREG FR4: 12 MILS \pm 1 MIL
 - BOTTOM LAYER PLATED TO 1 OZ
15. PLATE IN ACCORDANCE WITH IPC-4552, 118-236µIN OF NICKEL, WITH AN ADDITIONAL 2-6 µIN OF GOLD ON TOP.

SIZE	QTY	SYM	PLATED	TOL
30	92	+	YES	\pm 0.003"
8	194	X	YES	\pm 0.003"
6	39	□	YES	\pm 0.003"
40	2	◇	YES	\pm 0.003"



SILICON LABS - UDP-0018-002 (UPPI-F960)

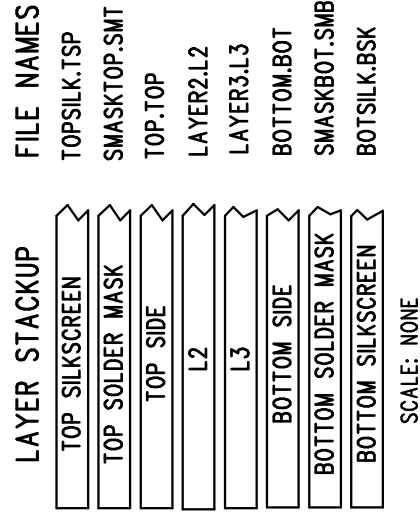

SCALE: NONE

Figure 17. UPPI-F960 Assembly Layer

UDP UPPI Card UG

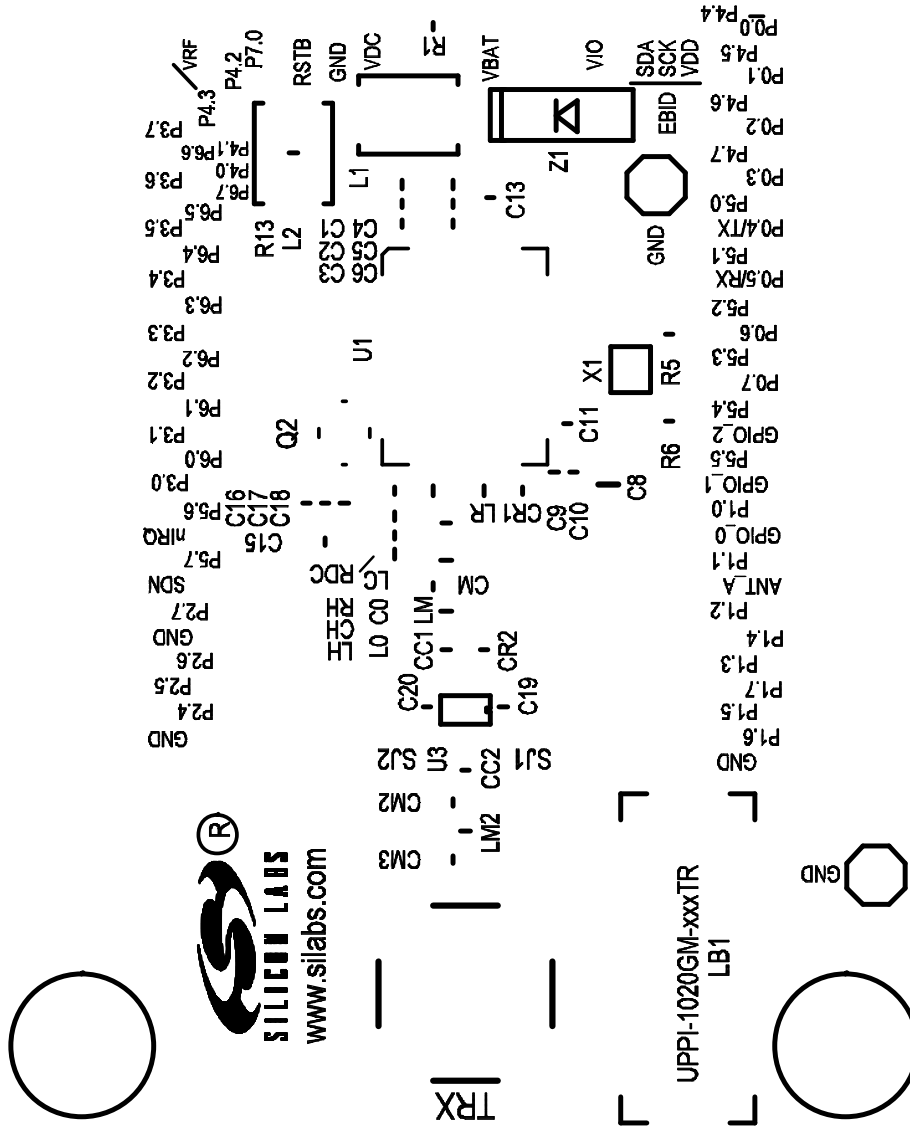

Figure 18. UPPI-1020-fffTR Silkscreen Top

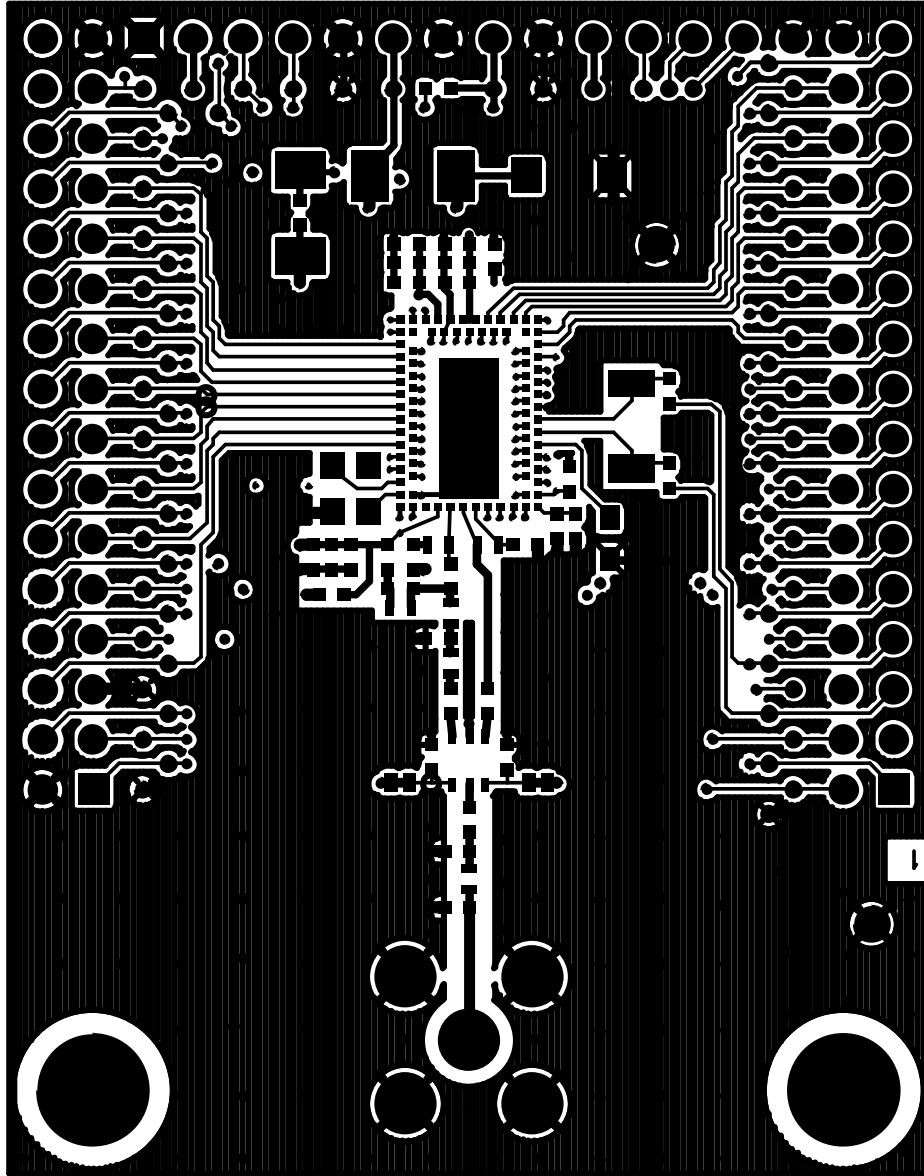

Figure 19. UPPI-1020-ffTR Top Side

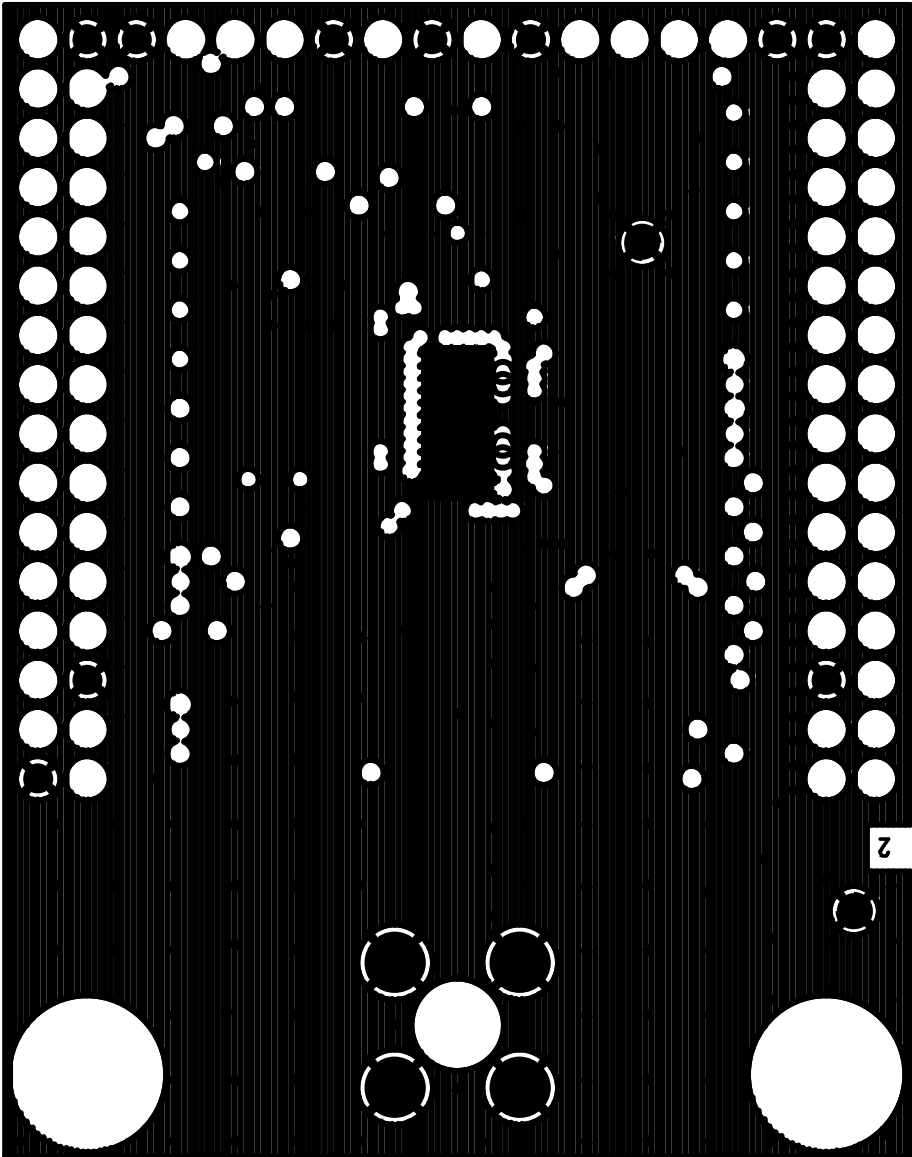

Figure 20. UPPI-1020-fffTR Layer 2

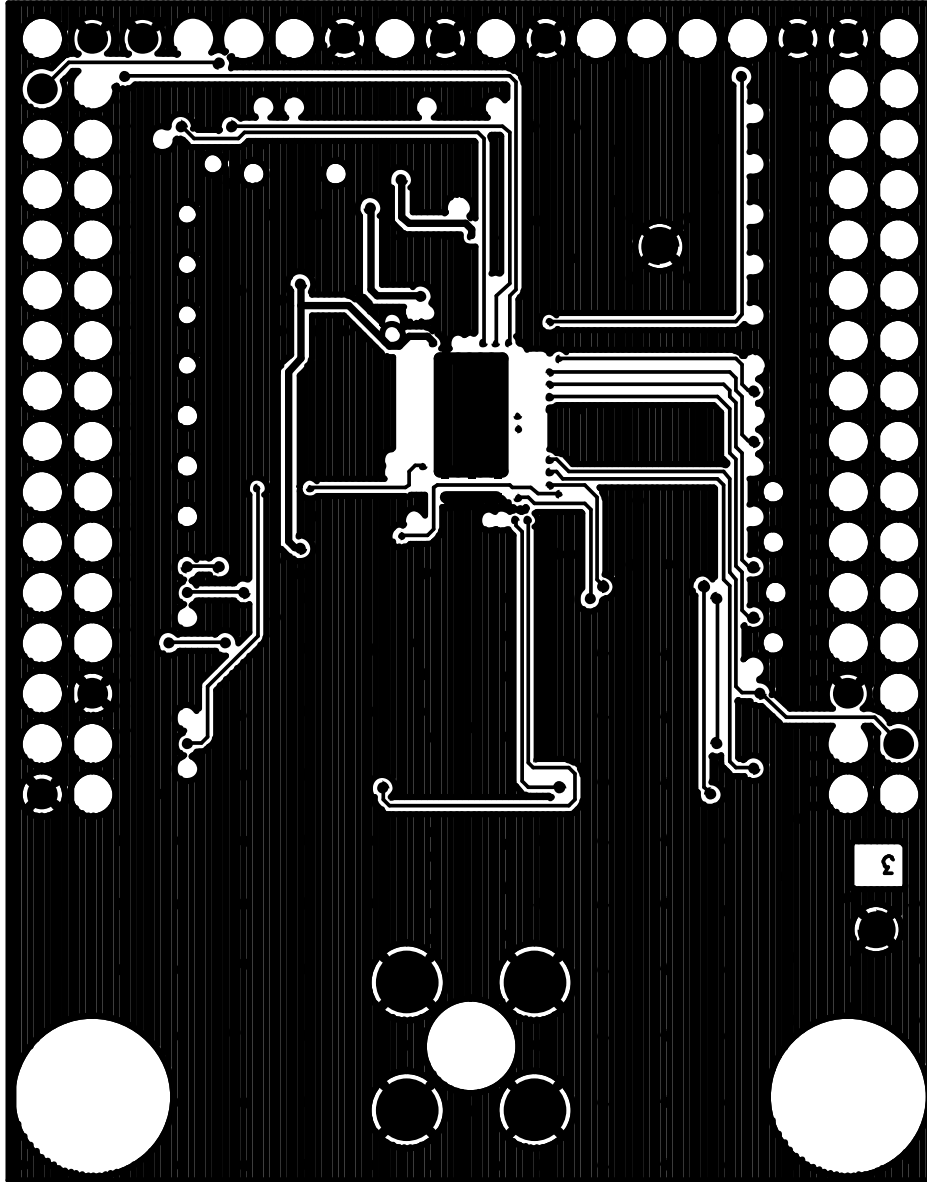

Figure 21. UPPI-1020-ffTR Layer 3

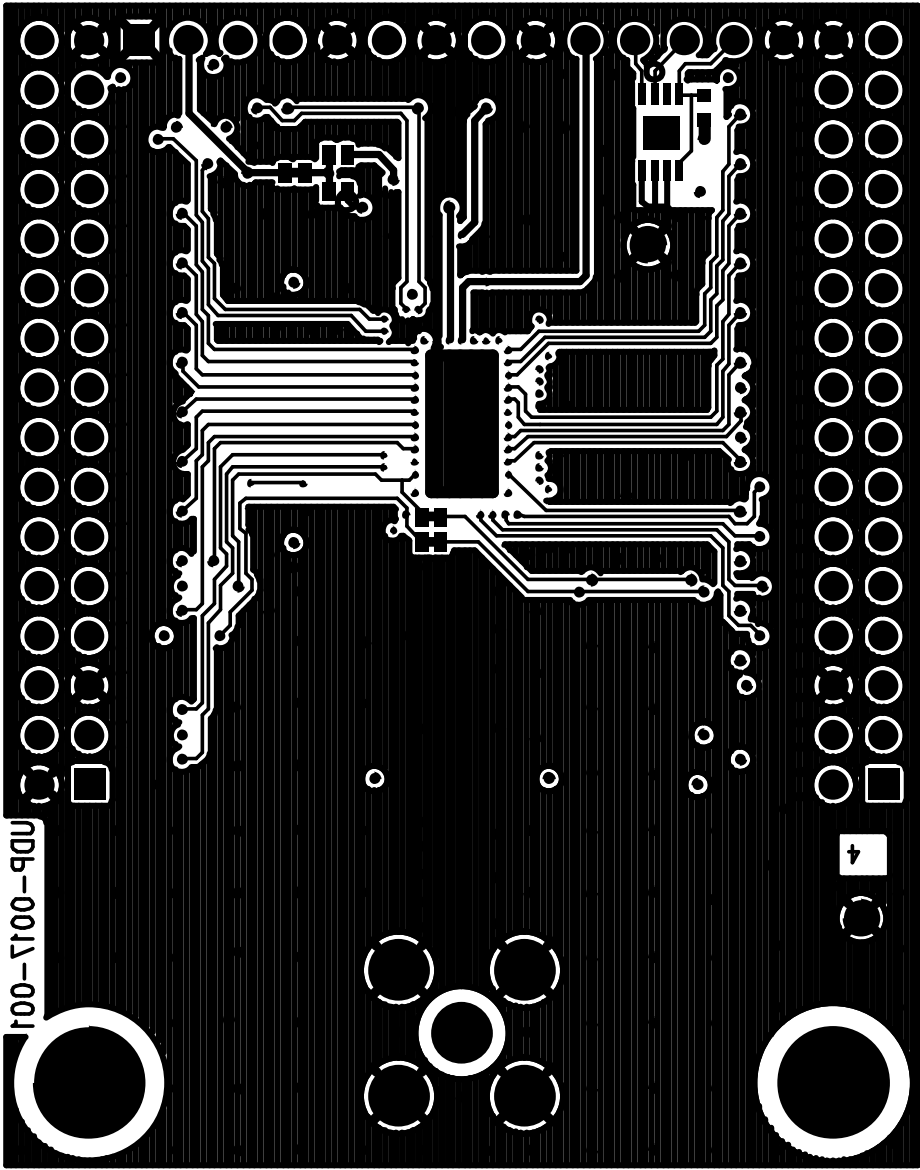
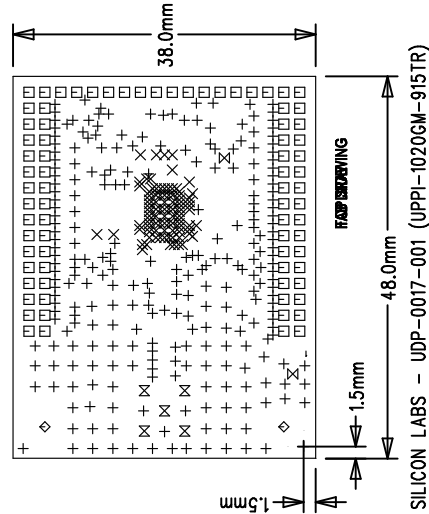

Figure 22. UPPI-1020-ffTR Bottom Side

NOTES : UNLESS OTHERWISE SPECIFIED

1. MANUFACTURE IN ACCORDANCE WITH IPC-6012, TYPE 3, CLASS 2.
2. END PRODUCT FEATURES SHALL NOT VARY MORE THAN 20% FROM ARTWORK ORIGINALS.
3. LAMINATE AND PREPREG SHALL BE AS PER IPC-4101/26,83,98 WITH A DECOMPOSITION TEMPERATURE \geq 345°C, COLOR, NATURAL.
4. COPPER WEIGHT SHALL BE 1.0 OZ./SQ. FT. BEFORE PLATING, UNLESS OTHERWISE SPECIFIED.
5. ALL PLATED THROUGH HOLES SHALL HAVE A MINIMUM OF 0.001" COPPER.
6. DRILL HOLE TOLERANCE AFTER PLATING SHALL BE \pm 0.003".
7. MINIMUM ANNULAR RING SHALL BE 0.001".
8. MINIMUM ANNULAR RING AT EMERGENT CONDUCTORS SHALL BE 0.003".
9. FINAL PCB THICKNESS SHALL BE 0.062" \pm 10% ACROSS PADS.
10. WARP/TWIST SHALL NOT EXCEED 0.010 INCH PER INCH.
11. FINISH SHALL BE LPI, BLUE S.M.O.B.C., BOTH SIDES.
12. SILKSCREEN WITH NONCONDUCTIVE WHITE EPOXY INK.
13. NO VENDOR MARKINGS OR ALTERATIONS SHALL BE PERMITTED ON ANY METAL OR SILKSCREEN LAYERS.
14. BOARD STACKUP:
 - TOP LAYER PLATED TO 1 OZ
 - PREPREG FR4: 12 MILS \pm 1 MIL
 - L2-GND 1 OZ Cu
 - PREPREG FR4: 28 MILS
 - L3-POWER 1 OZ Cu
 - PREPREG FR4: 12 MILS \pm 1 MIL
 - BOTTOM LAYER PLATED TO 1 OZ
15. PLATE IN ACCORDANCE WITH IPC-4552, 118-236uIN of NICKEL, WITH AN ADDITIONAL 2-6 uIN OF GOLD ON TOP.

SIZE	QTY	SYM	PLATED	TOL
0.008	261	+	YES	\pm 0.003"
0.006	91	X	YES	\pm 0.003"
0.03	78	□	YES	\pm 0.003"
0.125	2	◇	YES	\pm 0.003"
0.04	2	⊗	YES	\pm 0.003"
0.07	5	⊗	YES	\pm 0.003"



SILICON LABS - UDP-0017-001 (UPPI-1020GM-915TR)

Figure 23. UPPI-1020-fffTR Assembly Layer

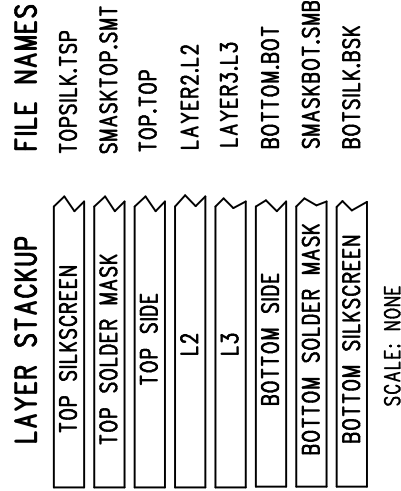

UDP UPPI Card UG

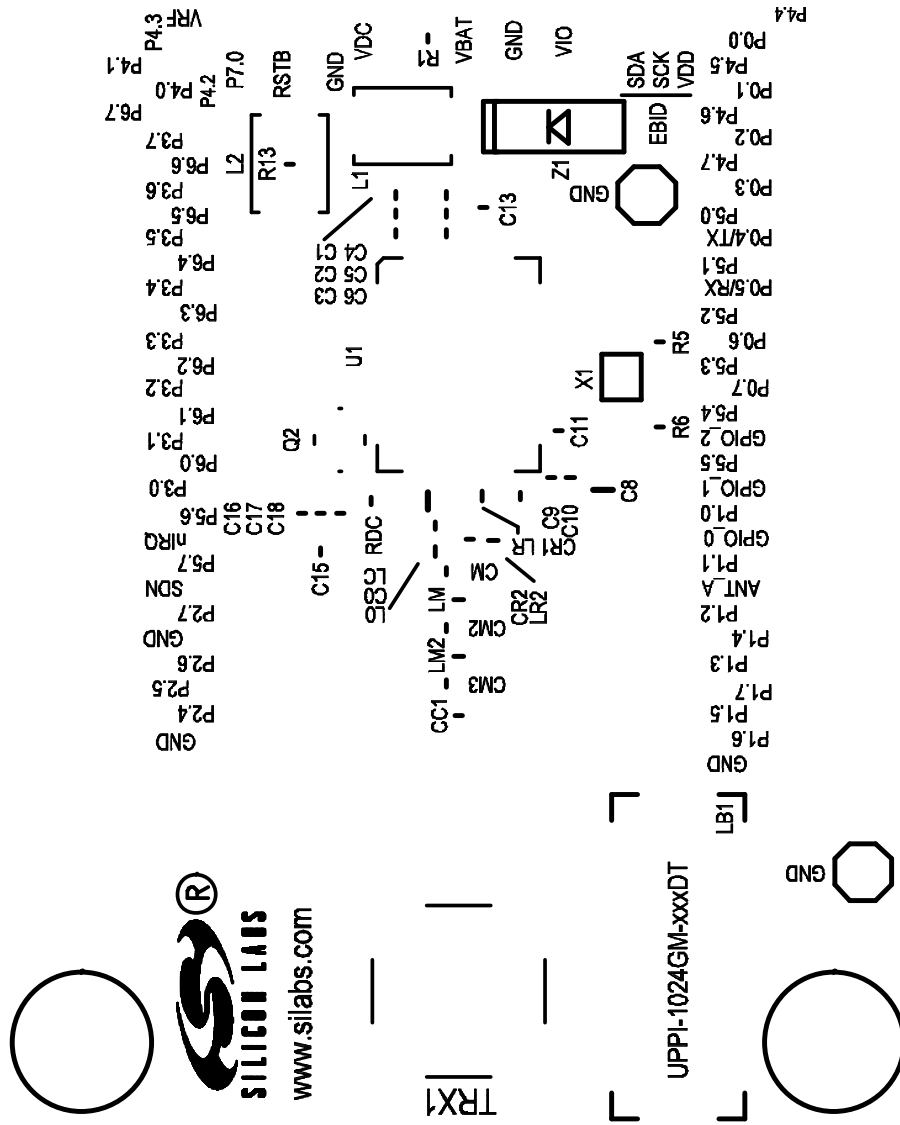

Figure 24. UPPI-1024-ffDT Silkscreen Top

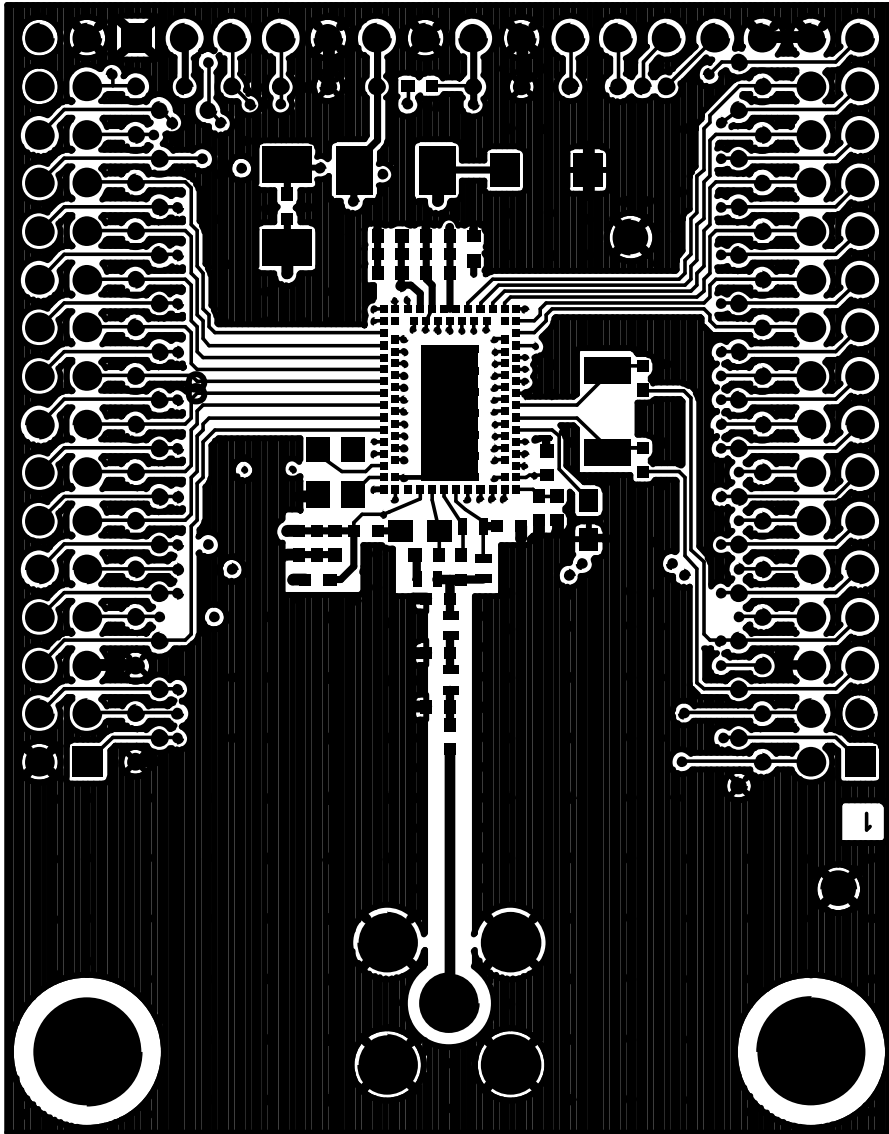

Figure 25. UPPI-1024-fffDT Top Side

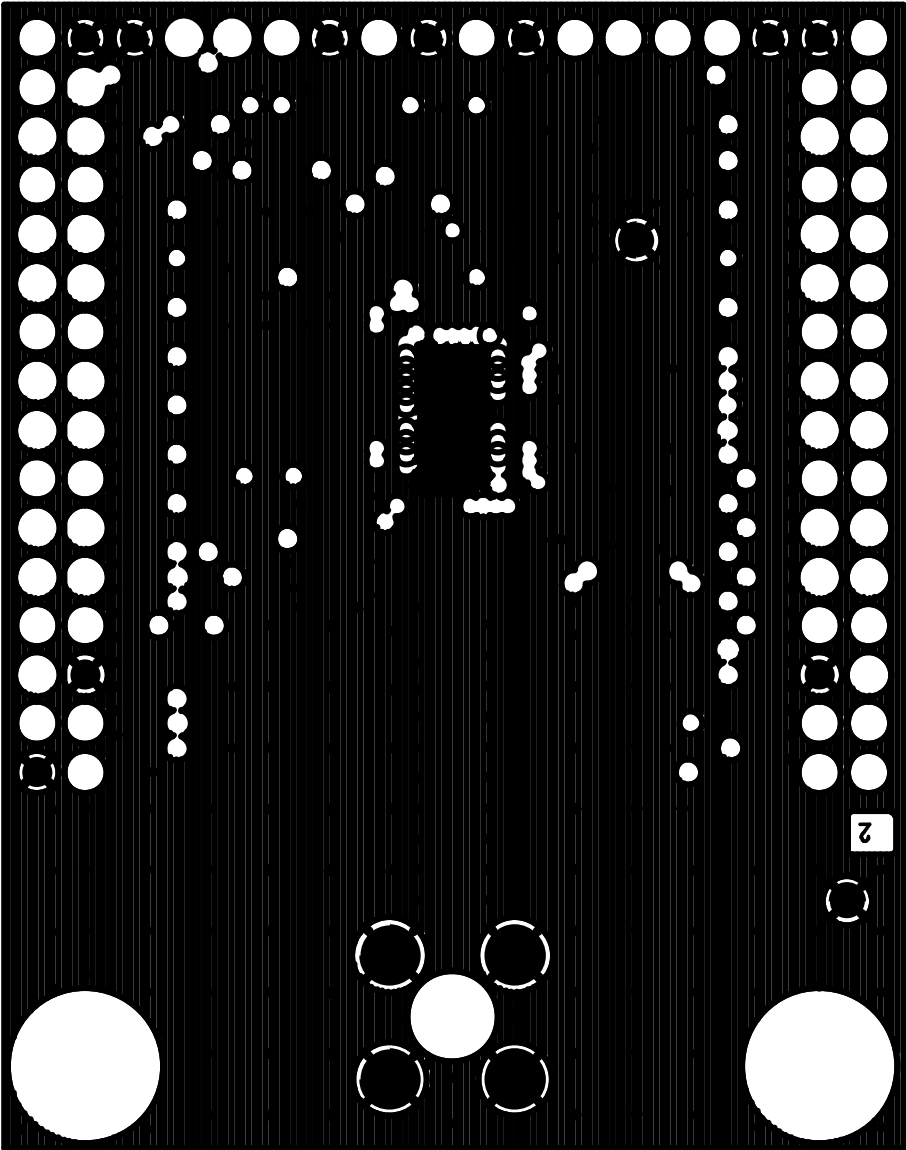

Figure 26. UPPI-1024-fffdT Layer 2

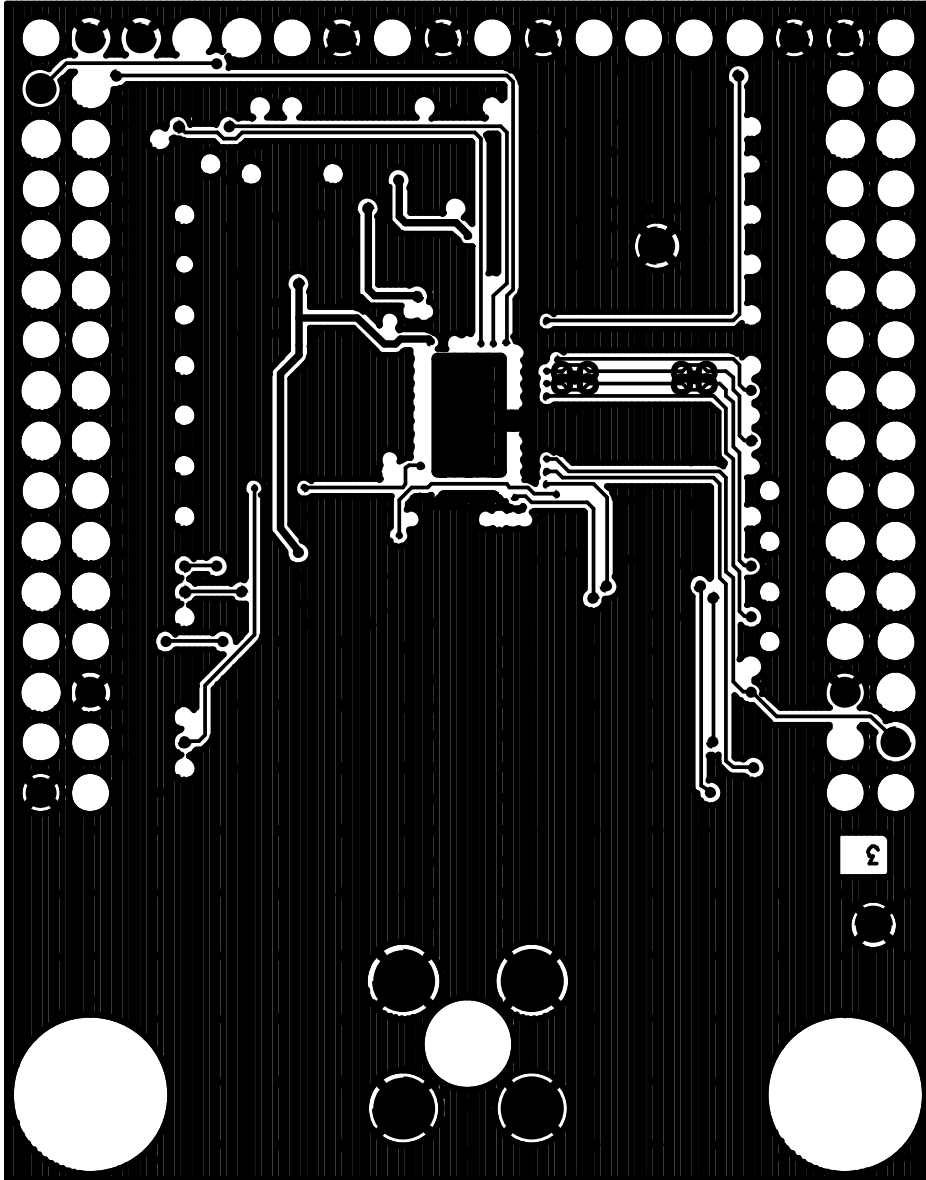

Figure 27. UPPI-1024-fffDT Layer 3

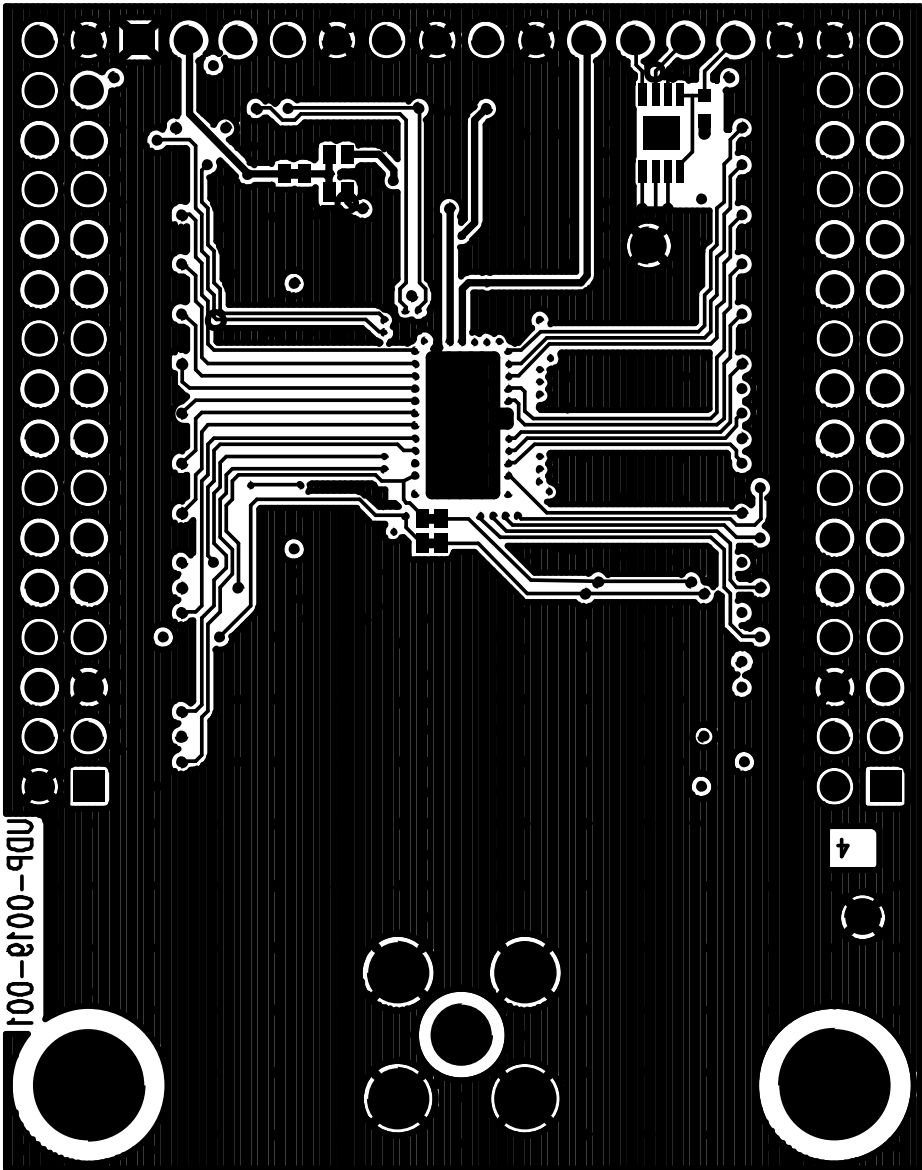

Figure 28. UPPI-1024-fffDT Bottom Side

NOTES : UNLESS OTHERWISE SPECIFIED

1. MANUFACTURE IN ACCORDANCE WITH IPC-6012, TYPE 3, CLASS 2.
2. END PRODUCT FEATURES SHALL NOT VARY MORE THAN 20% FROM ARTWORK ORIGINALS.
3. LAMINATE AND PREPREG SHALL BE AS PER IPC-4101/26,83,98 WITH A DECOMPOSITION TEMPERATURE $\geq 345^{\circ}\text{C}$, COLOR, NATURAL.
4. COPPER WEIGHT SHALL BE 1.0 OZ./SQ. FT. BEFORE PLATING, UNLESS OTHERWISE SPECIFIED.
5. ALL PLATED THROUGH HOLES SHALL HAVE A MINIMUM OF 0.001" COPPER.
6. DRILL HOLE TOLERANCE AFTER PLATING SHALL BE ± 0.003 ".
7. MINIMUM ANNULAR RING SHALL BE 0.001".
8. MINIMUM ANNULAR RING AT EMERGENT CONDUCTORS SHALL BE 0.003".
9. FINAL PCB THICKNESS SHALL BE 0.062" $\pm 10\%$ ACROSS PADS.
10. WARP/TWIST SHALL NOT EXCEED 0.010 INCH PER INCH.
11. FINISH SHALL BE LPI, BLUE S.M.O.B.C., BOTH SIDES.
12. SILKSCREEN WITH NONCONDUCTIVE WHITE EPOXY INK.
13. NO VENDOR MARKINGS OR ALTERATIONS SHALL BE PERMITTED ON ANY METAL OR SILKSCREEN LAYERS.
14. BOARD STACKUP:
 - TOP LAYER PLATED TO 1 OZ
 - PREPREG FR4: 12 MILS ± 1 MIL
 - L2-GND 1 OZ Cu
 - PREPREG FR4: 28 MILS
 - L3-POWER 1 OZ Cu
 - PREPREG FR4: 12 MILS ± 1 MIL
 - BOTTOM LAYER PLATED TO 1 OZ
15. PLATE IN ACCORDANCE WITH IPC-4552, 118-236uIN OF NICKEL, WITH AN ADDITIONAL 2-6 uIN OF GOLD ON TOP.

SIZE	QTY	SYM	PLATED	TOL
0.008	291	+	YES	± 0.003 "
0.006	91	×	YES	± 0.003 "
0.03	78	□	YES	± 0.003 "
0.125	2	◇	YES	± 0.003 "
0.04	2	⊗	YES	± 0.003 "
0.07	5	⊗	YES	± 0.003 "

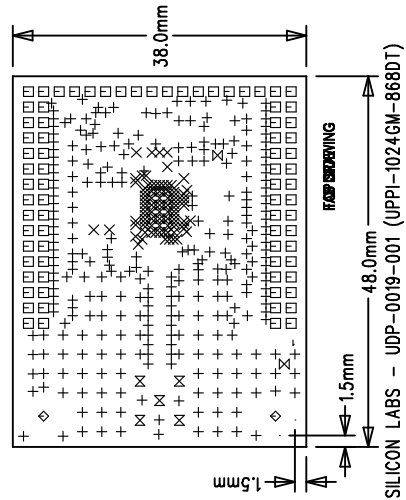
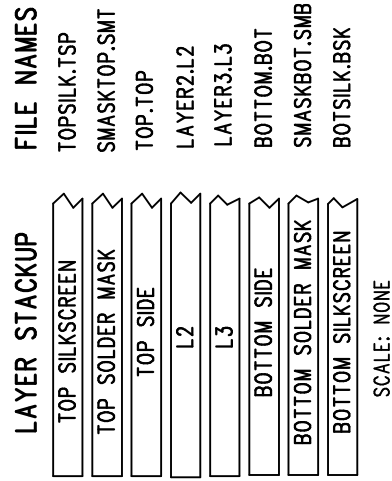

Figure 29. UPPI-1024-ffDT Assembly Layer



Simplicity Studio

One-click access to MCU and wireless tools, documentation, software, source code libraries & more. Available for Windows, Mac and Linux!



IoT Portfolio
www.silabs.com/IoT



SW/HW
www.silabs.com/simplicity



Quality
www.silabs.com/quality



Support and Community
community.silabs.com

Disclaimer

Silicon Laboratories intends to provide customers with the latest, accurate, and in-depth documentation of all peripherals and modules available for system and software implementers using or intending to use the Silicon Laboratories products. Characterization data, available modules and peripherals, memory sizes and memory addresses refer to each specific device, and "Typical" parameters provided can and do vary in different applications. Application examples described herein are for illustrative purposes only. Silicon Laboratories reserves the right to make changes without further notice and limitation to product information, specifications, and descriptions herein, and does not give warranties as to the accuracy or completeness of the included information. Silicon Laboratories shall have no liability for the consequences of use of the information supplied herein. This document does not imply or express copyright licenses granted hereunder to design or fabricate any integrated circuits. The products must not be used within any Life Support System without the specific written consent of Silicon Laboratories. A "Life Support System" is any product or system intended to support or sustain life and/or health, which, if it fails, can be reasonably expected to result in significant personal injury or death. Silicon Laboratories products are generally not intended for military applications. Silicon Laboratories products shall under no circumstances be used in weapons of mass destruction including (but not limited to) nuclear, biological or chemical weapons, or missiles capable of delivering such weapons.

Trademark Information

Silicon Laboratories Inc., Silicon Laboratories, Silicon Labs, SiLabs and the Silicon Labs logo, CMEMS®, EFM, EFM32, EFR, Energy Micro, Energy Micro logo and combinations thereof, "the world's most energy friendly microcontrollers", Ember®, EZLink®, EZMac®, EZRadio®, EZRadioPRO®, DSPLL®, ISOModem®, Precision32®, ProSLIC®, SiPHY®, USBXpress® and others are trademarks or registered trademarks of Silicon Laboratories Inc. ARM, CORTEX, Cortex-M3 and THUMB are trademarks or registered trademarks of ARM Holdings. Keil is a registered trademark of ARM Limited. All other products or brand names mentioned herein are trademarks of their respective holders.



SILICON LABS

Silicon Laboratories Inc.
 400 West Cesar Chavez
 Austin, TX 78701
 USA

<http://www.silabs.com>