

0RQB-D0T12x Series

Isolated DC-DC Converter

The 0RQB-D0T12x are isolated dc/dc converters that operate from a nominal 48 VDC source. These units will provide up to 216 W of output power from a nominal 48 VDC input. These units are designed to be highly efficient and low cost.

Features include remote on/off, over current protection, input under-voltage and output over voltage protection. These converters are provided in an industry standard quarter brick package.



Key Features & Benefits

- 48 VDC Input
- 12 VDC/ 18A Output
- Fixed Frequency (300 kHz)
- Output Over Voltage Latch Off
- Isolated
- Over Temperature Protection
- High Efficiency
- SCP/OCP
- High Power Density
- Low Cost
- Input Under Voltage Lockout
- Basic Insulation
- Remote On/Off
- TUV Certified to EN 60950-1
- Class II, Category 2, Isolated DC/DC Converter (refer to IPC-9592B)



bel POWER SOLUTIONS & PROTECTION

a bel group

belfuse.com/power-solutions

1. MODEL SELECTION

OUTPUT VOLTAGE	INPUT VOLTAGE	MAX. OUTPUT CURRENT	MAX. OUTPUT POWER	TYPICAL EFFICIENCY	MODEL NUMBER ACTIVE LOW	MODEL NUMBER ACTIVE HIGH
12 VDC	36 – 75 VDC	18 A	216 W	92.5%	ORQB-D0T12L	ORQB-D0T120

NOTE: Add “G” suffix at the end of the model number to indicate Tray Packaging.

PART NUMBER EXPLANATION

0	R	QB	-	D0	T	12	x	G
Mounting Type	RoHS Status	Series Name		Output Power	Input Range	Output Voltage	Active Logic	Package
Through hole mount	RoHS	1/4 th Brick		216W	36 – 75 V	12 V	0-Active high L-Active Low	G-Tray package

2. ABSOLUTE MAXIMUM RATINGS

PARAMETER	DESCRIPTION	MIN	TYP	MAX	UNITS
Continuous Input Voltage		-0.3	-	80	V
Remote On/Off		-0.3	-	18	V
I/O Isolation Voltage		-	-	2250	V
Ambient Temperature		-40	-	85	°C
Storage Temperature		-55	-	125	°C

NOTE: All specifications are typical at 25 °C unless otherwise stated

3. INPUT SPECIFICATIONS

PARAMETER	DESCRIPTION	MIN	TYP	MAX	UNIT
Input Voltage		36	48	75	V
Input Current (full load)		-	-	7	A
Input Current (no load)		-	110	200	mA
Remote Off Input Current			4	-	mA
Input Reflected Ripple Current (pk-pk)	With simulated source impedance of 12 μ H, 5 Hz to 20 MHz; use a 220 μ F/100 V electrolytic capacitor with ESR = 1 ohm max. at 200 kHz	-	20	-	mA
Input Reflected Ripple Current (rms)		-	5	40	mA
I2t Inrush Current Transient		-	TBD	-	
Turn-on Voltage Threshold		-	34	35	V
Turn-off Voltage Threshold		31	33	-	V

NOTE: All specifications are typical at nominal input, full load at 25 °C unless otherwise

4. OUTPUT SPECIFICATIONS

PARAMETER	DESCRIPTION	MIN	TYP	MAX	UNIT	
Output Voltage Set Point	Vin = 48 V, Io = 100% Load	11.76	12	12.24	V	
Line Regulation		-	20	-	mV	
Load Regulation		-	30	-	mV	
Regulation Over Temperature (-40 °C to 85 °C)		-	0.02	-	%Vo/°C	
Output Current		0	-	18	A	
Current Limit Threshold		19	21	27	A	
Output Ripple and Noise (pk-pk)	0 - 20 MHz BW, with 1 μ ceramic load capacitor and a 10 μF Tantalum capacitor at the output	-	85	150	mV	
Output Ripple and Noise (rms)		-	30	50	mV	
Turn on Time		-	10	-	ms	
Overshoot at Turn on		-	0	5	%	
Output Capacitance		-	-	6000	μF	
TRANSIENT RESPONSE						
ΔV 50% ~ 75% of Max Load	Overshoot	di/dt = 0.1 A/μs, Vin = 48 VDC, Ta = 25°C, with a 1 μF ceramic capacitor and a 10 μF Tantalum cap at output.	-	300	600	mV
	Settling Time		-	100	200	μs
ΔV 75% ~ 50% of Max Load	Overshoot		-	300	600	mV
	Settling Time		-	100	200	μs

NOTE: All specifications are typical at nominal input, full load at 25 °C unless otherwise stated.

5. GENERAL SPECIFICATIONS

PARAMETER	DESCRIPTION	MIN	TYP	MAX	UNIT
Efficiency	Vin = 48 V, full load	89	92.5	-	%
Switching Frequency		270	300	330	kHz
Remote Sense Compensation	The voltage increased by trim and sense should not exceed 110% Vout.	-	-	10	%
Output Voltage Trim Range		90	-	110	
Over Temperature Protection		-	130	-	°C
Over Voltage Protection	Vin = 48 V, Io = full load, Latch mode	13.5	-	15	V
MTBF	Calculated Per Bell Core SR-332 (Vin = 48 V, Vo = 12 V, Io = 14.4 A, 300LFM forced air flow, Ta = 25 °C)	-	1,632,203	-	Million hour
ISOLATION CHARACTERISTICS					
Isolation Capacitance		-	3000	-	pF
Weight		-	48	-	g
Dimensions (L x W xH)		2.30 x 1.45 x 0.394 58.42 x 36.83 x 10.00			in mm

NOTE: All specifications are typical at 25 °C unless otherwise stated.



Asia-Pacific
+86 755 298 85888

Europe, Middle East
+353 61 225 977

North America
+1 408 785 5200

6. EFFICIENCY DATA

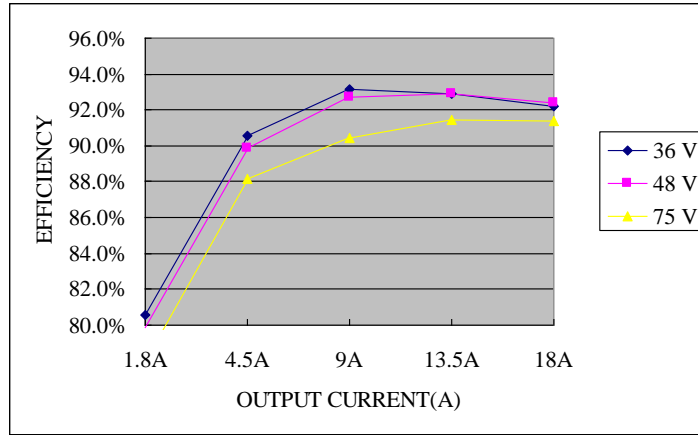

7. REMOVE ON/OFF

PARAMETER	DESCRIPTION	MIN	TYP	MAX	UNIT
REMOTE ON/OFF					
Signal Low (Unit On)	Active Low	The remote on/off pin open, Unit off.	-	0.8	V
Signal High (Unit Off)					
Signal Low (Unit Off)	Active High	The remote on/off pin open, Unit on.	-	0.8	V
Signal High (Unit On)					

8. THERMAL DERATING CURVES

With maximum junction temperature of semiconductors derated to 120°C.

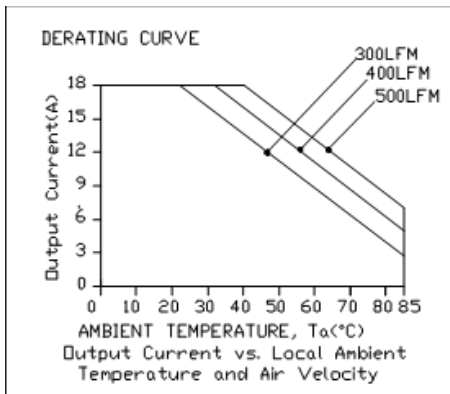

Figure 1. Vin=75 V

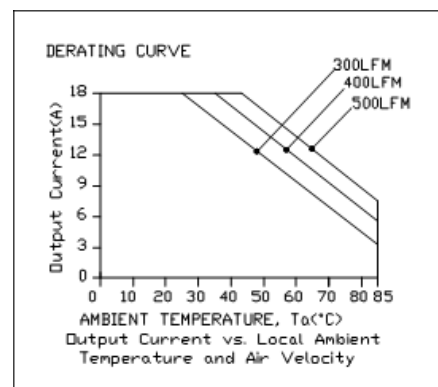
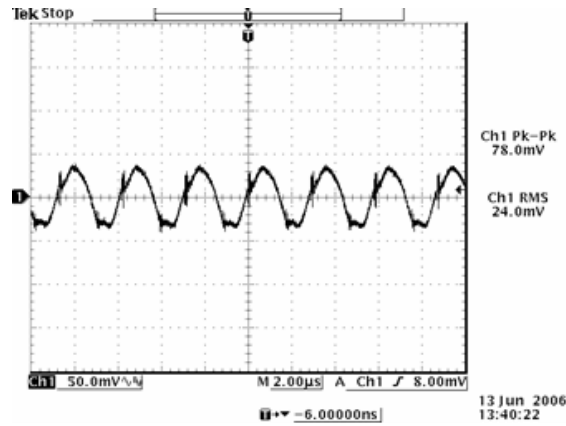

Figure 2. Vin=48 V

9. RIPPLE AND NOISE WAVEFORM



NOTE: Ripple and noise at full load, 48 VDC input, 12 VDC/18 A output, and with a 1 µF ceramic cap and a 10 µF tantalum cap at the output, $T_a = 25^\circ\text{C}$.

10. TRANSIENT RESPONSE WAVEFORMS

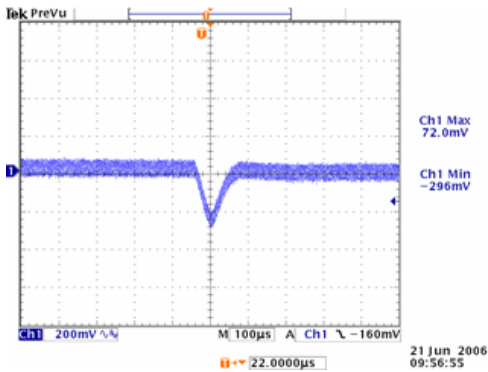

Figure 3. $V_{out}=12\text{ V}$, 50% to 75% Load Transients at 12 V,
 $T_a = 25^\circ\text{C}$

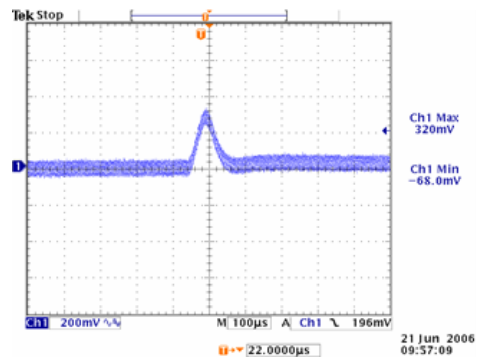

Figure 4. $V_{out}=12\text{ V}$, 75% to 50% Load Transients at 48 V
 $T_a = 25^\circ\text{C}$

NOTE: Transients response at $di/dt = 0.1\text{ A}/\mu\text{s}$, $V_{in} = 48\text{ VDC}$, $T_a=25^\circ\text{C}$, with 1 µF ceramic capacitor and a 10µF Tantalum capacitor at the output.

11. TRIM

Equations for calculating the trim resistor are shown below. The Trim Down resistor should be connected between the Trim pin and GND pin. The Trim Up resistor should be connected between the Trim pin and the Vout pin. Only one of the resistors should be used for any given application.

$$R_{trimdown} = \frac{511}{|\delta|} - 10.22 [k\Omega]$$

$$R_{trimup} = \frac{(100 + \delta) \cdot V_o \cdot 5.11 - 625}{1.225 \cdot \delta} - 10.22 [k\Omega]$$

NOTE:

$$\delta = \frac{(V_o_{req} - V_o)}{V_o} \times 100 [\%]$$

Output voltage $V_o = 12.004$ V

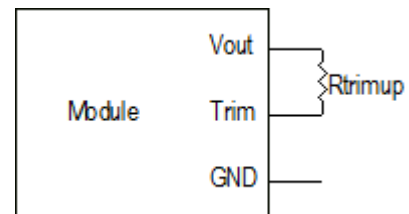
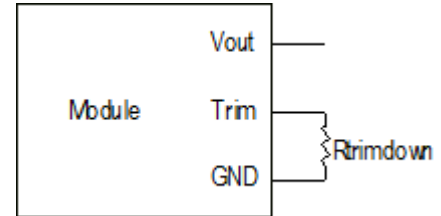

12. MECHANICAL OUTLINE

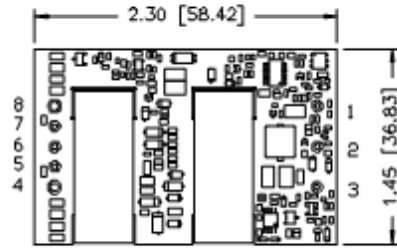
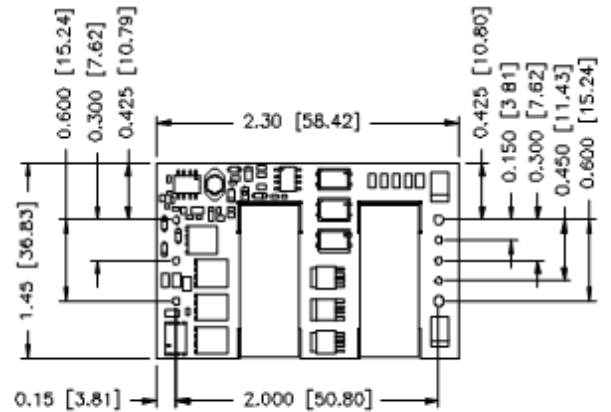

BOTTOM VIEW

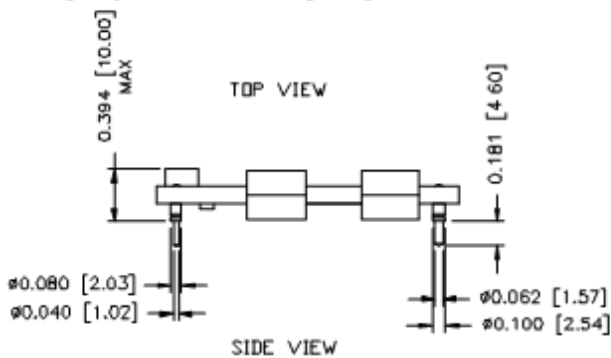

SIDE VIEW

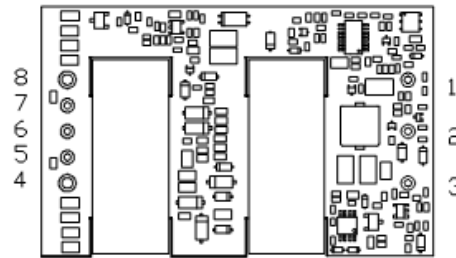

BOTTOM VIEW

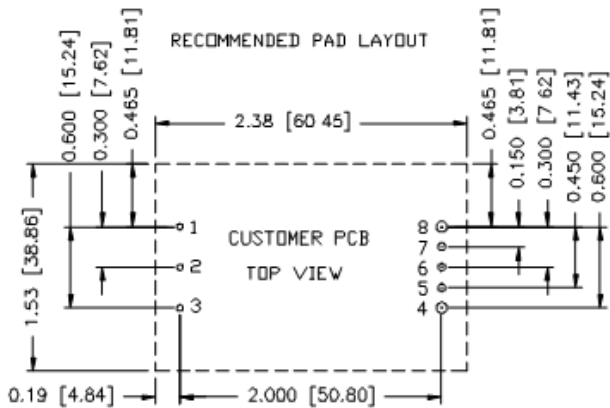

1,2,3,5,6,7 ϕ 0.047 HOLE SIZE, ϕ 0.08 min PAD SIZE
 4,8 ϕ 0.07 HOLE SIZE, ϕ 0.10 min PAD SIZE

PIN CONNECTIONS

PIN	FUNCTION	PIN SIZE
1	Vin(+)	0.040"
2	On/Off	0.040"
3	Vin(-)	0.040"
4	Vo(-)	0.062"
5	RS(-)	0.040"
6	Trim	0.040"
7	RS(+)	0.040"
8	Vo(+)	0.062"

NOTE: This module is recommended and compatible with Pb-Free Wave Soldering and must be soldered using a peak solder temperature of no more than 260 °C for less than 5 seconds.

NOTES:

- 1) All Pins: Material – Copper Alloy;
Finish – Tin plated.
- 2) Undimensioned components are shown for visual reference only.
- 3) All dimensions in inches (mm); Tolerances: x.xx +/-0.02 in[0.51mm]. x.xxx +/-0.010 in[0.25mm].



Asia-Pacific
+86 755 298 85888

Europe, Middle East
+353 61 225 977

North America
+1 408 785 5200

13. INSTALLATION INSTRUCTION

- 1) The DC-DC Converter can be operated at an ambient temperature up to 80°C maximum.
- 2) The DC-DC Converter is a built-in component. During installation into certain equipment the relevant requirements of EN 60950-1:2001 + A11 and IEC 60950-1:2001 shall be maintained.
- 3) The creepage distances, clearances and thickness of insulation between unearthed hazardous voltage input and SELV output circuits have complied with basic insulation requirements according to EN 60950-1:2001 + A11 and IEC 60950-1:2001.
- 4) The output ratings as shown on the label must not be exceeded.
- 5) The equipment is to be supplied from a DC source which is separated from AC mains by double or reinforced insulation, or by basic insulation and suitable earthing providing equivalent protection.
- 6) The equipment is intended to be installed into a class I or class II system, when installed into class I system, protective earth has to be reliably identified and suitable external protection devices have to be provided in the final system.
- 7) The equipment shall be installed with an external forced air-cooling according to installation instruction. The airflow direction is towards the side of the equipment.

14. REVISION HISTORY

DATE	REVISION	CHANGES DETAIL	APPROVAL
2006-01-20	VP1	First Release	YC Xu/Yan
2006-06-15	VP2	Update mechanical drawing, no load input current, load regulation, line regulation, Output Ripple and Noise, Output DC Current Limit ,Output Capacitance, Turn on Time, Efficiency ,Over Temperature Protection ,trim function, Turn on Voltage Threshold, Turn off Voltage Threshold, Transient Response ,weight	WQ YING
2006-07-12	VP3	Output Capacitance, Remoted Off Input Current.	WQ YING
2006-12-28	A	Add MTBF data,	WQ YING
2007-09-12	B	Update MD.	XF Jiang
2012-07-02	C	Add 260C for 10seconds maximum Paste in Hole Process in MD.	XF Jiang
2013-06-19	D	Update the picture.	XF jiang

For more information on these products consult: tech.support@psbel.com

NUCLEAR AND MEDICAL APPLICATIONS - Products are not designed or intended for use as critical components in life support systems, equipment used in hazardous environments, or nuclear control systems.

TECHNICAL REVISIONS - The appearance of products, including safety agency certifications pictured on labels, may change depending on the date manufactured. Specifications are subject to change without notice.



tech.support@psbel.com
belfuse.com/power-solutions