

# Half-Bridge Gate Driver

## 1200 V 2.5 A Source/3.4 A Sink

### FAD8253MX-1

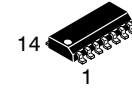

SOIC-14 NB  
CASE 751A

#### Description

The FAD8253 is a monolithic half-bridge gate driver IC designed for driving high voltage, high speed and high power IGBTs up to +1200 V. The FAD8253 employs ON's high-voltage process and common-mode noise canceling technique to provide stable operation of high-side driver under high dv/dt noise circumstances. The gate driver includes UVLO circuits tailored to IGBT threshold for both high side and low side outputs to prevent malfunction when  $V_{DD}$  and  $V_{BS}$  are lower than the specified threshold voltage.

The FAD8253 offers a built-in low-side current detection circuitry with an additional provision for soft shutdown (for low side) during overcurrent or short-circuit conditions. The driver can provide adequate protection during short-circuits by turning off its outputs while simultaneously generating a fault output for fault reporting purposes. The driver also provides additional flexibility by providing a shutdown pin to disable driver outputs externally.

#### Features

- Floating Channel for Bootstrap Operation to +1200 V
- Peak Output Current Capability of 2.5 A Source/3.4 A Sink
- Allowable Negative  $V_S$  Transient Swing of up to -15 V at  $V_{BS} = 15$  V
- Built-in Common Mode dv/dt Noise Canceling Circuit
- Separate Power and Signal Ground for Enhanced di/dt Immunity
- Matched Propagation Delay < 50 ns
- 3.3 V and 5 V Input Logic Compatible
- Built in Shoot-through Prevention Logic with 120 ns (Typ) Dead Time
- Built-in UVLO Functions for both High and Low Side with Thresholds Optimized for IGBTs
- Built-in Low Side Short-circuit Protection with Soft Shutdown
- In SOIC14NB with Non Connected Pins for High Voltage Creepage and Clearance Requirements
- Fault Reporting during Overcurrent or Short-circuit Condition
- External Shutdown Pin to Enable or Disable Driver Outputs
- AEC-Q100 Qualified and PPAP Capable
- Pb-Free Devices

#### Typical Applications

- High Voltage Auxiliary Motor Drive
- Generic Half-Bridge and Full-Bridge Driver
- On-Board Chargers & DC/DC Converters
- Traction Inverters

#### MARKING DIAGRAM

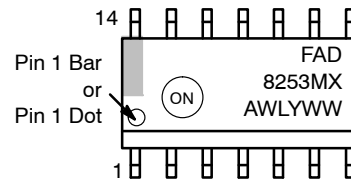

FAD8253MX = Specific Device Code  
A = Assembly Location  
WL = Wafer Lot  
Y = Year  
WW = Work Week

#### PIN ASSIGNMENT

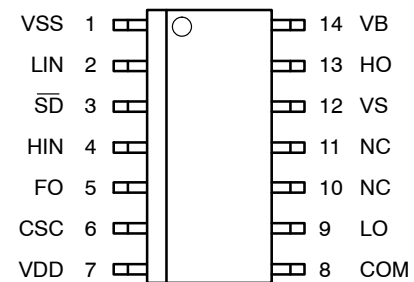

#### ORDERING INFORMATION

Device	Package	Shipping <sup>†</sup>
FAD8253MX-1	SOIC-14 NB (Pb-Free)	2,500 / Tape & Reel

<sup>†</sup>For information on tape and reel specifications, including part orientation and tape sizes, please refer to our Tape and Reel Packaging Specification Brochure, BRD8011/D.

# FAD8253MX-1

## APPLICATION DIAGRAMS

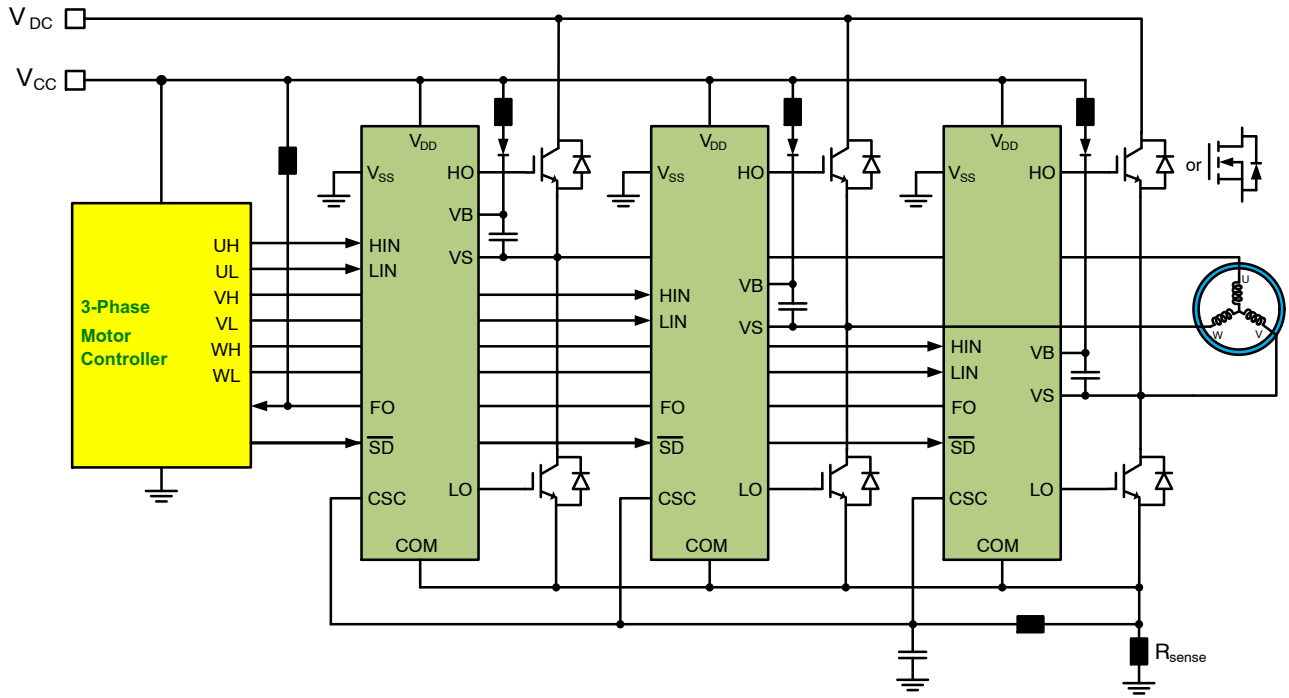

Figure 1. 3-Phase Motor Drive Application

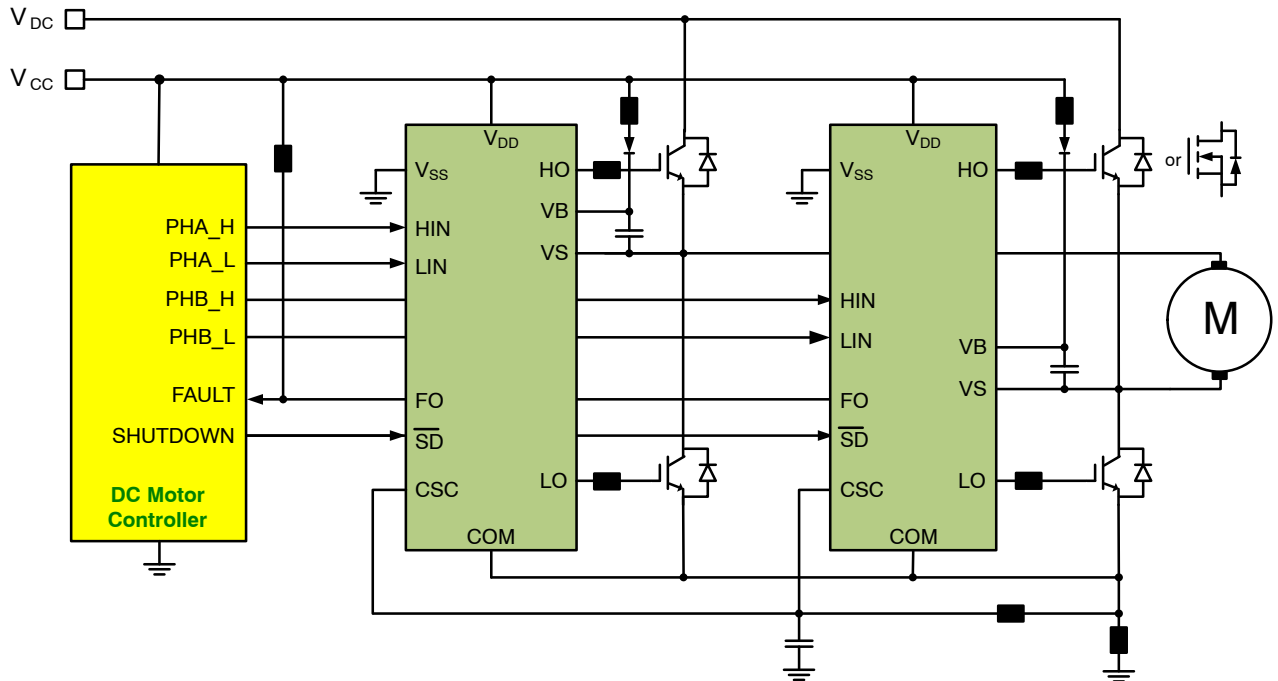

Figure 2. DC Motor Drive Application

# FAD8253MX-1

## BLOCK DIAGRAM

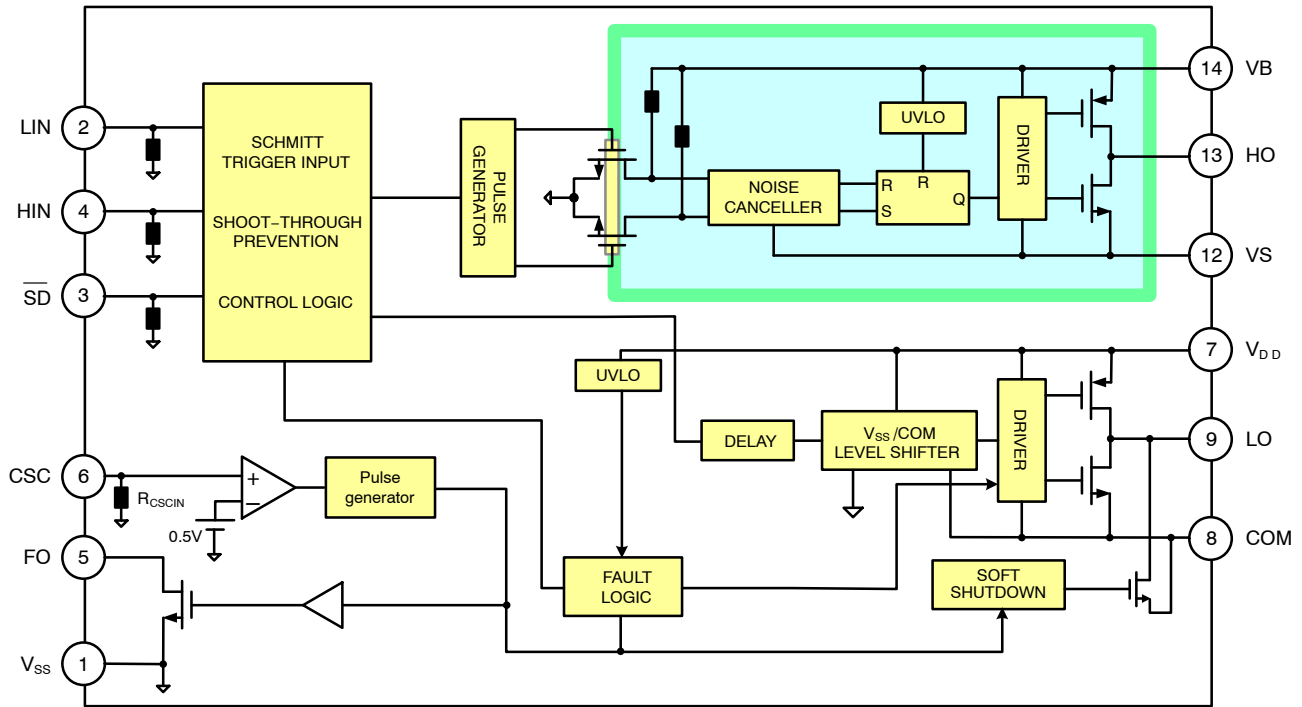

Figure 3. Block Diagram

## PIN DESCRIPTION

### PIN FUNCTION DESCRIPTION

Pin No.	Name	Description
1	VSS	Logic Ground
2	LIN	Logic Input for Low-Side Gate Driver Output
3	SD	Shutdown Control Input with Active Low
4	HIN	Logic Input for High-Side Gate Driver Output
5	FO	Fault Output with Open Drain (Low True)
6	CSC	Short-Circuit Current Detection Input
7	VDD	Low-Side and Logic Power Supply Voltage
8	COM	Low-side Driver Return
9	LO	Low-Side Driver Output
12	VS	High-Side Floating Supply Return
13	HO	High-Side Driver Output
14	VB	High-Side Floating Supply
10, 11	NC	No Connect

# FAD8253MX-1

## SPECIFICATIONS

### ABSOLUTE MAXIMUM RATINGS (T<sub>A</sub> = 25°C, unless otherwise specified.)

Symbol	Rating	Value	Unit
V <sub>S</sub>	High-side Offset Voltage V <sub>S</sub>	(V <sub>B</sub> - 25) to (V <sub>B</sub> + 0.3)	V
V <sub>B</sub>	High-side Floating Supply Voltage V <sub>B</sub>	-0.3 to 1225	V
V <sub>HO</sub>	High-side Floating Output Voltage	(V <sub>S</sub> - 0.3) to (V <sub>B</sub> + 0.3)	V
V <sub>DD</sub>	Low-side and Logic-fixed Supply Voltage	-0.3 to 25	V
V <sub>IN</sub>	Logic Input Voltage (HIN, LIN, $\overline{SD}$ )	-0.3 to (V <sub>DD</sub> + 0.3)	V
V <sub>CSC</sub>	Current Sense Input Voltage	-0.3 to (V <sub>DD</sub> + 0.3)	V
dV <sub>S</sub> /dt	Allowable Offset Voltage Slew Rate	50	V/ns
P <sub>D</sub>	Power Dissipation (SO14NB) (Note 1)	0.8	W
θ <sub>JA</sub>	Thermal Resistance, Junction-to-Ambient (SO14NB)	156	°C/W
T <sub>J(max)</sub>	Junction Temperature	+150	°C
TSTG	Storage Temperature	-55 to +150	°C
ESDHBM	ESD, Human Body Model (Note 3)	2500	V
ESDCDM	ESD, Charged Device Model (Note 3)	750	V

Stresses exceeding those listed in the Maximum Ratings table may damage the device. If any of these limits are exceeded, device functionality should not be assumed, damage may occur and reliability may be affected.

- Do not exceed PD under any circumstances.
- Mounted on 76.2 × 114.3 × 1.6 mm PCB (FR-4 glass epoxy material). Refer to the following standards:
  - JESD51-2: Integral circuits thermal test method environmental conditions – natural convection
  - JESD51-3: Low effective thermal conductivity test board for leaded surface mount packages
- This device series incorporates ESD protection and is tested by the following methods:
  - ESD Human Body Model tested per ANSI/ESDA/JEDEC JS-001-2012
  - ESD Charged Device Model tested per JESD22-C101

### RECOMMENDED OPERATING RANGES (Parameters are referenced to V<sub>SS</sub>)

Symbol	Rating	Min	Max	Unit
V <sub>DD</sub>	Supply Voltage Range	4.5	18.0	V
V <sub>S</sub>	High-Side V <sub>S</sub> Floating Supply Offset Voltage (Note 4)	5 - V <sub>BS</sub>	1200	V
V <sub>BS</sub>	High-side V <sub>BS</sub> Bootstrap Voltage	V <sub>BSUV+</sub>	22	V
V <sub>HO</sub>	High-Side Output Voltage	V <sub>S</sub>	V <sub>B</sub>	V
V <sub>DD</sub>	Low-Side and Logic Supply Voltage	V <sub>DDUV+</sub>	22	V
V <sub>LO</sub>	Low-Side Output Voltage	COM	V <sub>DD</sub>	V
V <sub>IN</sub>	Logic Input Voltage (IN, $\overline{SD}$ )	V <sub>SS</sub>	V <sub>DD</sub>	V
COM	Power Ground	V <sub>DD</sub> - 22	V <sub>DD</sub>	V
T <sub>A</sub>	Ambient Temperature (Note 5)	-40	125	°C

Functional operation above the stresses listed in the Recommended Operating Ranges is not implied. Extended exposure to stresses beyond the Recommended Operating Ranges limits may affect device reliability.

- Recommended based on min 5 V on V<sub>B</sub>, for proper operation of the level shifter circuit and ensure proper propagation of the signal from the input to the output.
- Power and thermal impedance should be determined with care so that T<sub>j</sub> does not exceed 150°C.

# FAD8253MX-1

## ELECTRICAL CHARACTERISTICS

( $V_{BIAS}$  ( $V_{DD}$ ,  $V_{BS}$ ) = 15 V,  $T_A$  = -40°C to 125°C unless otherwise specified. The  $V_{IN}$  and  $I_{IN}$  parameters are referenced to  $V_{SS}$ . The  $V_O$  and  $I_O$  parameters are referenced to  $V_S$  and COM and are applicable to the respective outputs HO and LO.)

Symbol	Parameter	Test Conditions	Min	Typ	Max	Unit
--------	-----------	-----------------	-----	-----	-----	------

### LOW SIDE POWER SUPPLY SECTION

$I_{QDD}$	Quiescent $V_{DD}$ Supply Current	$V_{LIN} = 0$ V or 5 V	50	280	400	$\mu$ A
$I_{PDD}$	Operating $V_{DD}$ Supply Current	$C_L = 1$ nF, $f_{LIN} = 20$ kHz, rms value	400	660	800	$\mu$ A
$V_{DDUV+}$	$V_{DD}$ Supply Under-Voltage Positive-going Threshold	$V_{DD} =$ Rising	11	12	12.9	V
$V_{DDUV-}$	$V_{DD}$ Supply Under-voltage Negative going Threshold	$V_{DD} =$ Falling	10.5	11.4	12.4	V
$V_{DDHYS}$	$V_{DD}$ Supply Under-voltage Lockout Hysteresis		-	0.6	-	V

### BOOSTRAPPED POWER SUPPLY SECTION

$I_{QBS}$	Quiescent $V_{BS}$ Supply Current	$V_{HIN} = 0$ V or 5 V	-	25	45	$\mu$ A
$I_{PBS}$	Operating $V_{BS}$ Supply Current	$C_L = 1$ nF, $f_{HIN} = 20$ kHz, rms value	-	430	550	$\mu$ A
$I_{LK}$	Offset Supply Leakage Current	$V_B = V_S = 1200$ V	-	-	120	$\mu$ A
$V_{BSUV+}$	$V_{BS}$ Supply Under-Voltage Positive-going Threshold	$V_{BS} =$ Rising	10.6	11.7	12.5	V
$V_{BSUV-}$	$V_{BS}$ Supply Under-voltage Negative Going Threshold	$V_{BS} =$ Falling	10.1	11.1	11.9	V
$V_{BSHYS}$	$V_{BS}$ Supply Under-voltage Lockout Hysteresis		-	0.6	-	V

### GATE DRIVER OUTPUT SECTION

$V_{OH}$	High-level Output Voltage, $V_{BIAS}-V_O$	$I_O = 0$ mA (No Load)	-	-	50	mV
$V_{OL}$	Low-level Output Voltage, $V_O$	$I_O = 0$ mA (No Load)	-	-	50	mV
$I_{O+}$	Output HIGH Short-circuit Pulsed Current	$V_O = 0$ V, $V_{IN} = 5$ V with $PW < 10$ $\mu$ s	1200	2700	-	mA
$I_{O-}$	Output LOW Short-circuit Pulsed Current	$V_O = 15$ V, $V_{IN} = 0$ V with $PW < 10$ $\mu$ s	1200	4200	-	mA
$V_S$	Allowable Negative $V_S$ Pin Voltage, with Signal Propagation Capability from HIN to HO	$V_{BS} = 15$ V	-10.0	-	-	V
$V_S$ (Note 6)	Allowable Transient Negative $V_S$ Pin Voltage, No Signal Propagation Capability from HIN to HO	$V_{BS} = 15$ V	-15.0	-	-	V
COM- $V_{SS}$	Allowable COM- $V_{SS}$ Power/Signal Grounds Offset	$V_{DD} = 15$ V, $V_{SS} = 0$ V	-7.0	-	-	V

### LOGIC INPUT SECTION (HIN, LIN, SD)

$V_{IH}$	Logic "1" Input Voltage Threshold		-	-	2.5	V
$V_{IL}$	Logic "0" Input Voltage Threshold		1.2	-	-	V
$V_{INHYS}$	Logic Input Hysteresis Voltage		-	0.5	-	V
$I_{IN+}$	Logic "1" Input Bias Current (HIN, LIN)	$V_{IN} = 5$ V	-	23	-	$\mu$ A
$I_{IN-}$	Logic "0" Input Bias Current (HIN, LIN)	$V_{IN} = 0$ V	-	-	2.0	$\mu$ A
$\overline{I}_{SD+}$	Logic "1" Input Bias Current ( $\overline{SD}$ )	$V_{\overline{SD}} = 5$ V	-	15.7	-	$\mu$ A
$\overline{I}_{SD-}$	Logic "0" Input Bias Current ( $\overline{SD}$ )	$V_{\overline{SD}} = 0$ V	-	-	2.0	$\mu$ A

### SHORT-CIRCUIT PROTECTION

$V_{CSREF}$	Short-circuit detector reference voltage		0.45	0.50	0.6	V
$R_{CSCIN}$	Input Pull Down Short Circuit Resistance		-	210	-	k $\Omega$
$I_{CSCIN}$	Short-Circuit Input Current	$V_{CSCIN} = 5$ V	15	23.5	37.5	$\mu$ A
$I_{SOFT}$	Soft Turn-off Source Current	$V_{DD} = 15$ V, $L_O = 7.5$ V	70	110	140	mA

# FAD8253MX-1

## ELECTRICAL CHARACTERISTICS (continued)

( $V_{BIAS}$  ( $V_{DD}$ ,  $V_{BS}$ ) = 15 V,  $T_A$  = -40°C to 125°C unless otherwise specified. The  $V_{IN}$  and  $I_{IN}$  parameters are referenced to  $V_{SS}$ . The  $V_O$  and  $I_O$  parameters are referenced to  $V_S$  and COM and are applicable to the respective outputs HO and LO.)

Symbol	Parameter	Test Conditions	Min	Typ	Max	Unit
--------	-----------	-----------------	-----	-----	-----	------

### FAULT DETECTION SECTION

$V_{FOH}$	Fault Output High Level Voltage	$V_{CSC} = 0$ V, $R_{PULL-UP} = 4.7$ k $\Omega$	4.7	-	-	V
$V_{FOL}$	Fault Output Low Level Voltage	$V_{CSC} = 1$ V, $I_{FO} = 2$ mA	-	-	0.8	V

### DYNAMIC OUTPUT SECTION

( $V_{BIAS}$  ( $V_{DD}$ ,  $V_{BS}$ ) = 15.0 V,  $T_A$  = -40°C to 125°C,  $V_S = V_{SS}$ ,  $C_{LOAD} = 1000$  pF unless otherwise specified.)

$t_{on}$	Turn-on Propagation Delay (Note 7)	$V_S = 0$ V	65	100	145	ns
$t_{off}$	Turn-off Propagation Delay	$V_S = 0$ V or 1200 V	65	90	145	ns
$t_{SDOFF\_LO}$	$\overline{SD}$ to Low-side Propagation Delay		25	45	70	ns
$t_{SDOFF\_HO}$	$\overline{SD}$ to How-side Propagation Delay		65	95	145	ns
$t_r$	Turn-on Rise Time		-	13	25	ns
$t_f$	Turn-off Fall Time		-	15	26	ns
$Mt_{ON}$	Delay Matching HO and LO Turn-On		-	-	25	ns
$Mt_{OFF}$	Delay Matching HO and LO Turn-Off		-	-	25	ns
DT	Dead-time (Note 8)		70	120	200	ns
$t_{UVFLT}$	Under-voltage Filtering Time (Note 6)		-	10	-	$\mu$ s
$t_{CSCFLT}$	CSC Pin Filtering Time (Note 6)		-	300	-	ns
$t_{CSCFO}$	Time from CSC Triggering to FO		-	530	1250	ns
$t_{FO}$	Fault Output Pulse Width		24	65	140	$\mu$ s
$t_{CSCLO}$	Time from CSC Triggering to Low-side and High-side Gate Output	From $V_{CSC} = 1$ V to starting gate turn-off	-	600	1350	ns

Product parametric performance is indicated in the Electrical Characteristics for the listed test conditions, unless otherwise noted. Product performance may not be indicated by the Electrical Characteristics if operated under different conditions.

6. Parameter guaranteed by design.

7. The turn-on propagation delay does not include the dead time.

8. The dead time includes the turn on propagation time.

TYPICAL CHARACTERISTICS

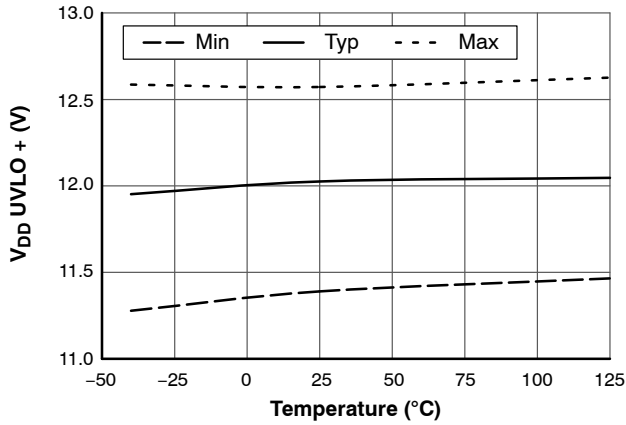

Figure 4. V<sub>DD</sub> UVLO (+) vs. Temperature

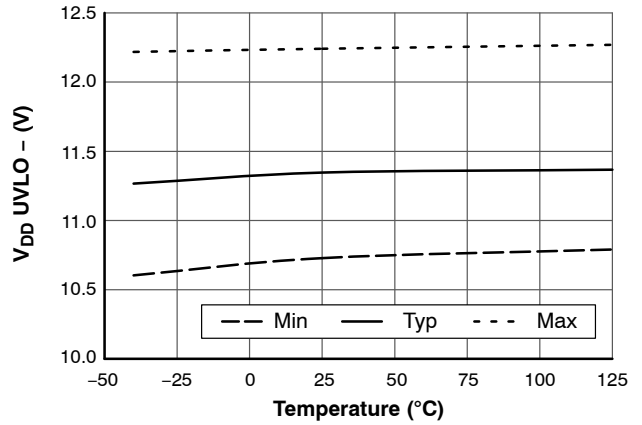

Figure 5. V<sub>DD</sub> UVLO (-) vs. Temperature

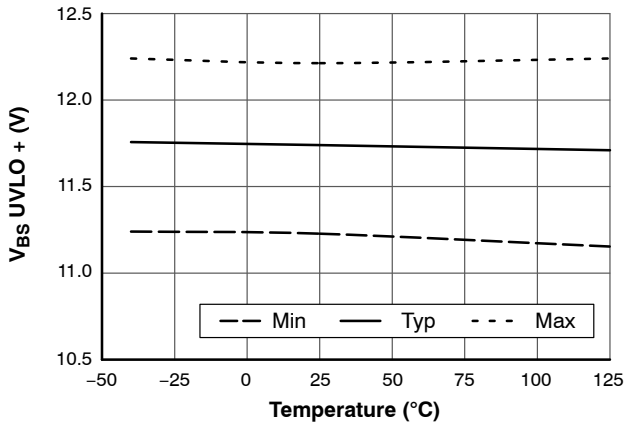

Figure 6. V<sub>BS</sub> UVLO (+) vs. Temperature

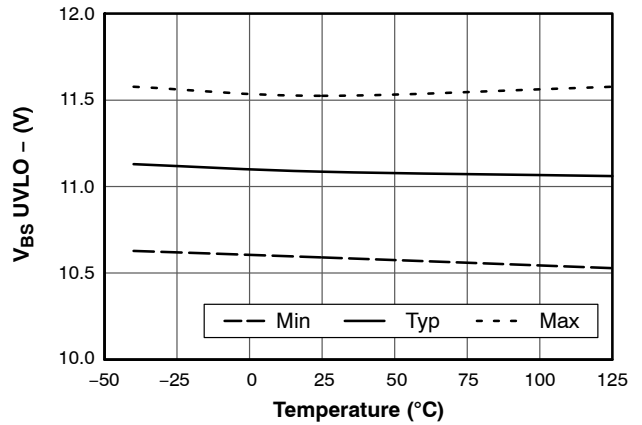

Figure 7. V<sub>BS</sub> UVLO (-) vs. Temperature

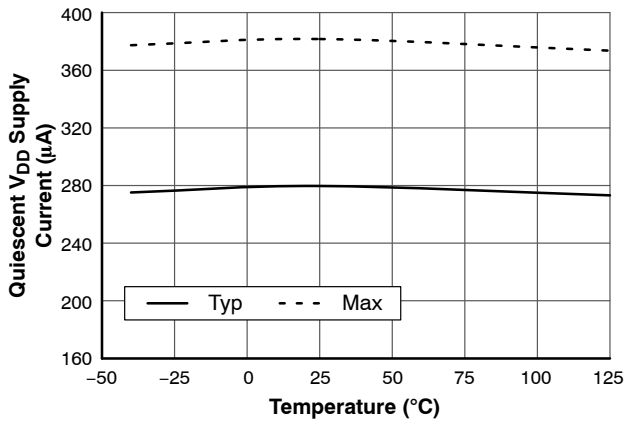

Figure 8. V<sub>DD</sub> Quiescent Current vs. Temperature

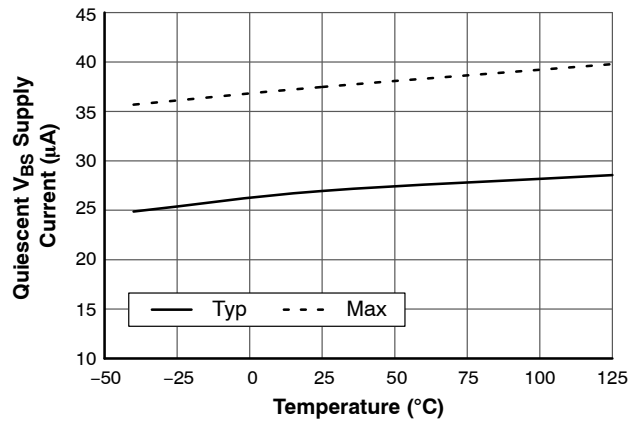

Figure 9. V<sub>BS</sub> Quiescent Current vs. Temperature

TYPICAL CHARACTERISTICS (Continued)

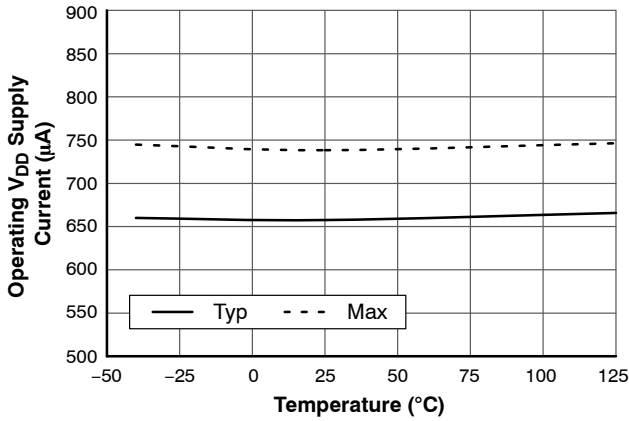

Figure 10.  $V_{DD}$  Operating Current vs. Temperature

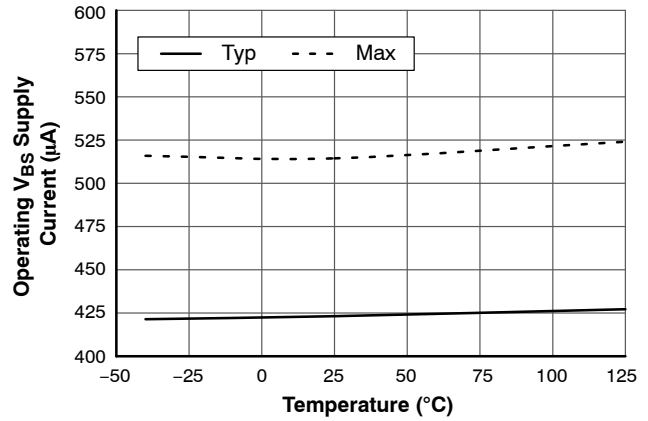

Figure 11.  $V_{BS}$  Operating Current vs. Temperature

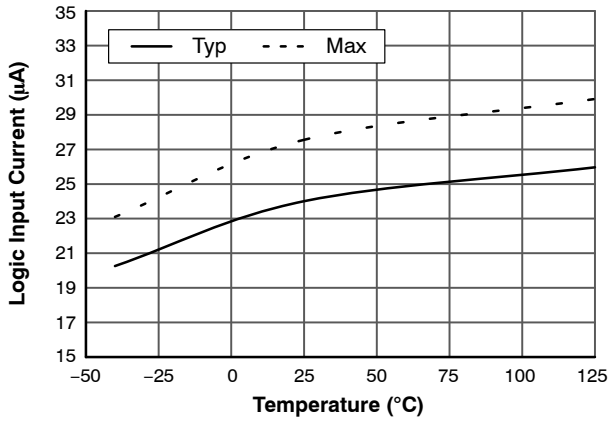

Figure 12. Logic High Input Bias Current vs. Temperature

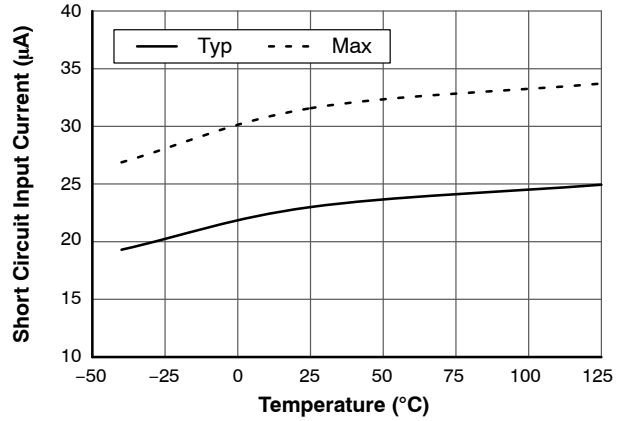

Figure 13.  $I_{CSCIN}$  vs. Temperature

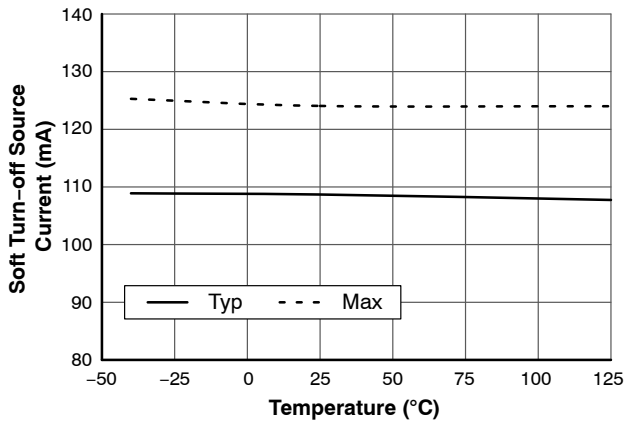

Figure 14.  $I_{SOFT}$  vs. Temperature

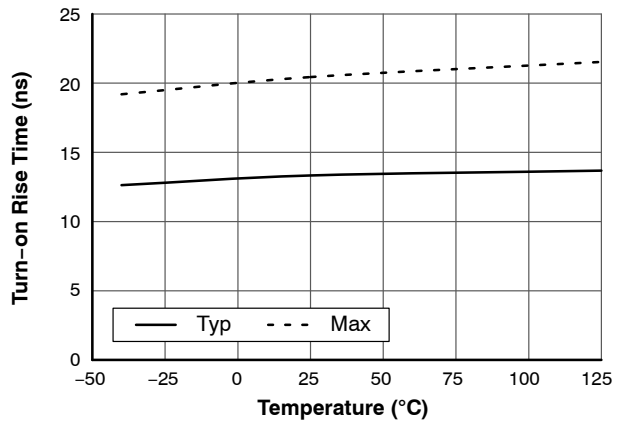

Figure 15. Turn-on Rising Time vs. Temperature



TYPICAL CHARACTERISTICS (Continued)

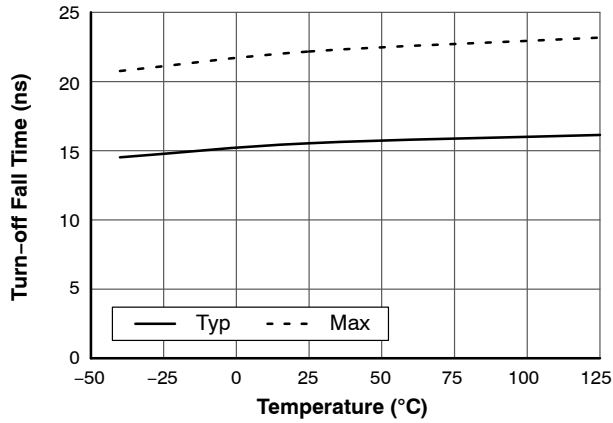

Figure 16. Turn-off Falling Time vs. Temperature

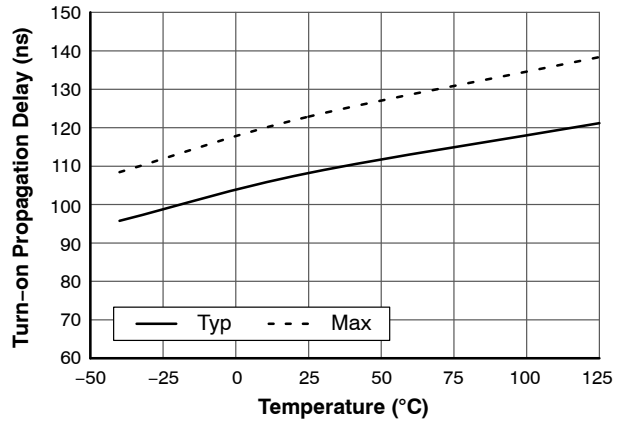

Figure 17. Turn-on Delay Time vs. Temperature

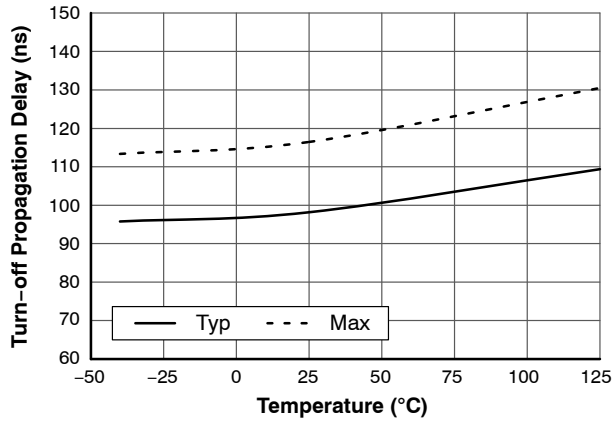

Figure 18. Turn-off Delay time vs. Temperature

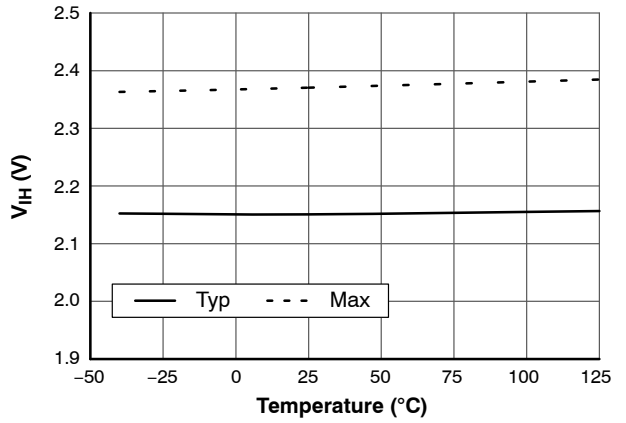

Figure 19. Logic High Input Voltage Threshold vs. Temperature

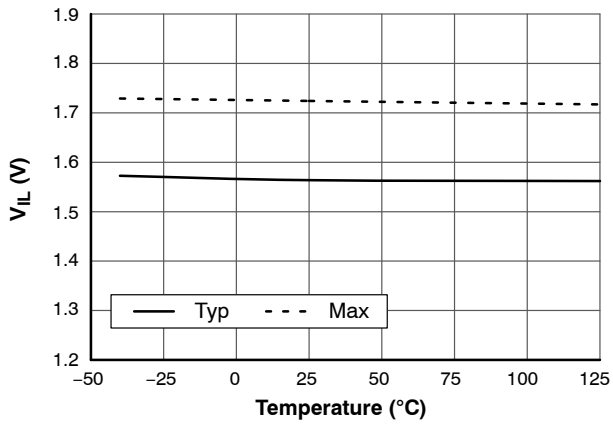

Figure 20. Logic Low Input Voltage Threshold vs. Temperature

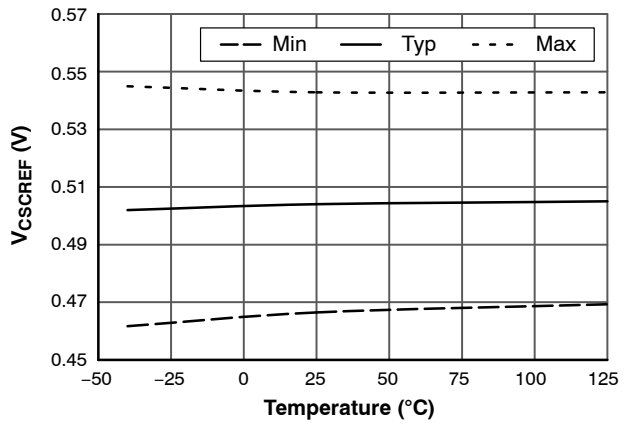

Figure 21.  $V_{CSCREF}$  vs. Temperature

TYPICAL CHARACTERISTICS (Continued)

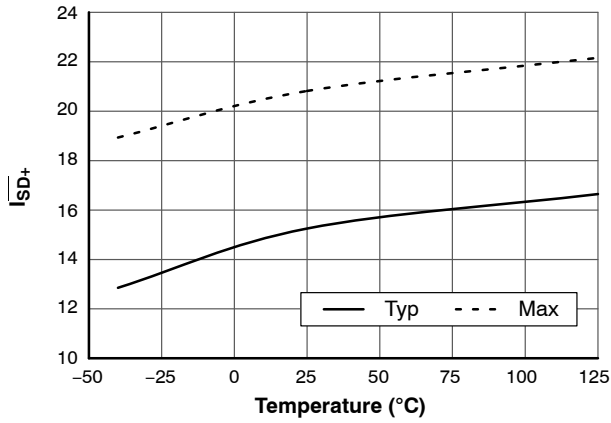

Figure 22. SD Logic High Input Bias Current vs. Temperature

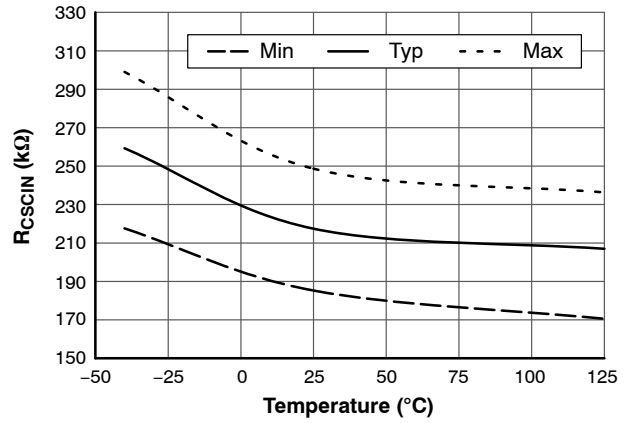

Figure 23. Input Pull Down Short Circuit Resistance vs. Temperature

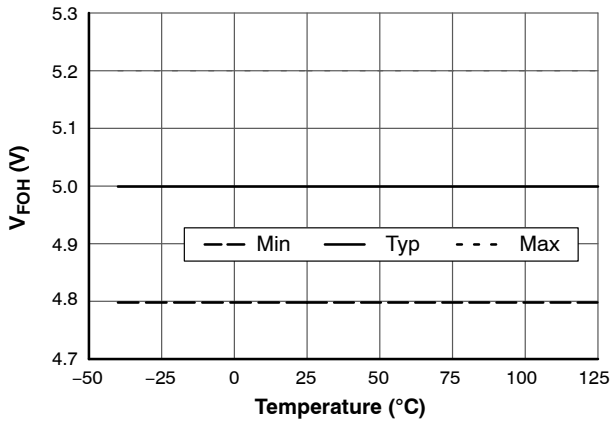

Figure 24. Fault Output High Level Voltage vs. Temperature

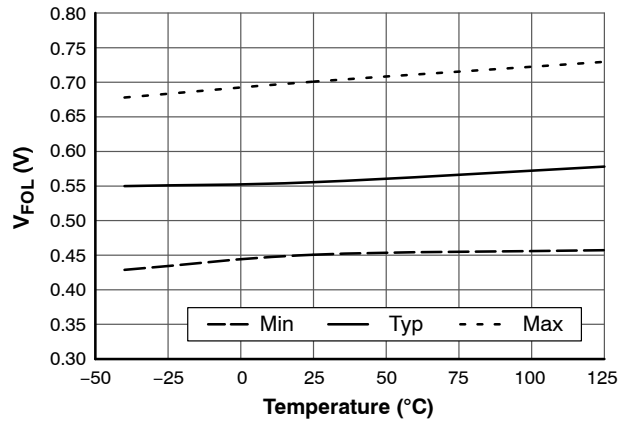

Figure 25. Fault Output Low Level Voltage vs. Temperature

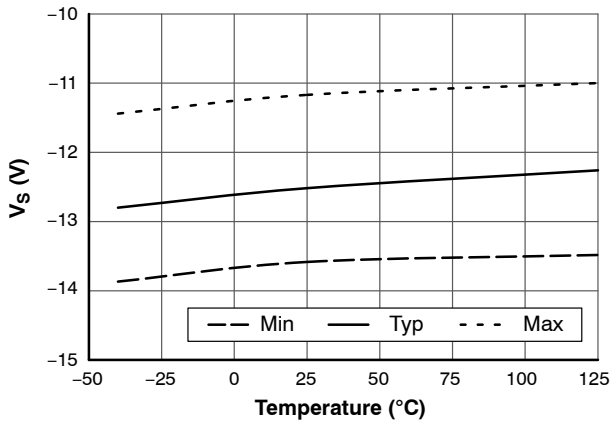

Figure 26. Allowable Negative V<sub>S</sub> Voltage vs. Temperature

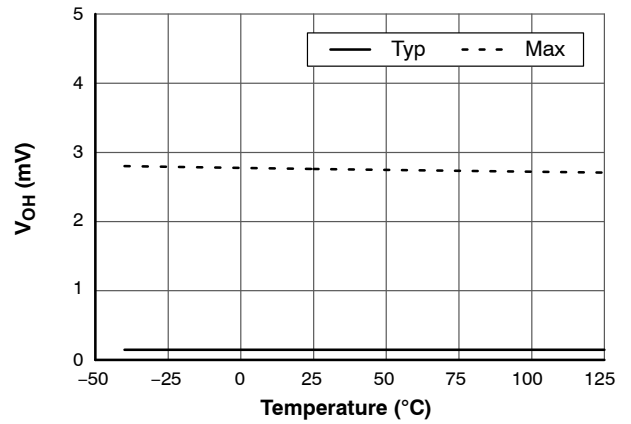

Figure 27. High-level Output Voltage vs. Temperature

TYPICAL CHARACTERISTICS (Continued)

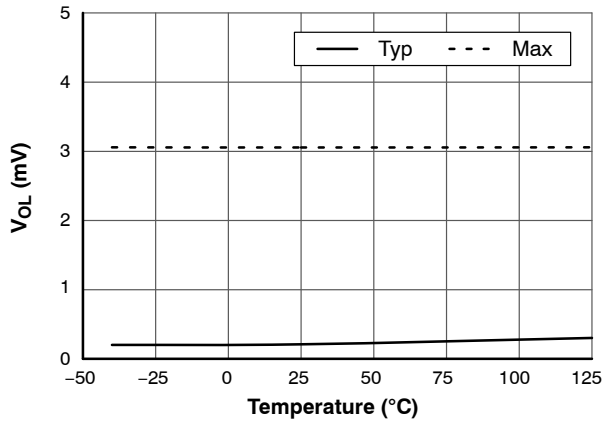

Figure 28. Low-level Output Voltage vs. Temperature

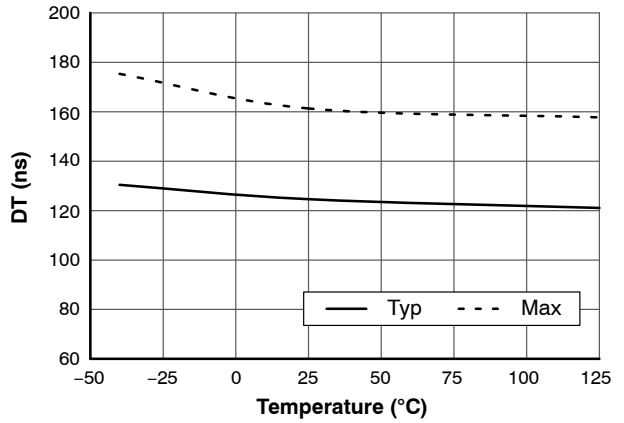

Figure 29. Dead Time vs. Temperature

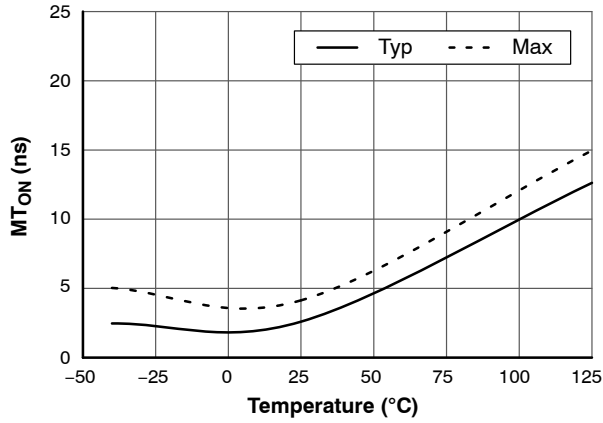

Figure 30. Delay Matching HO and LO Turn-on vs. Temperature

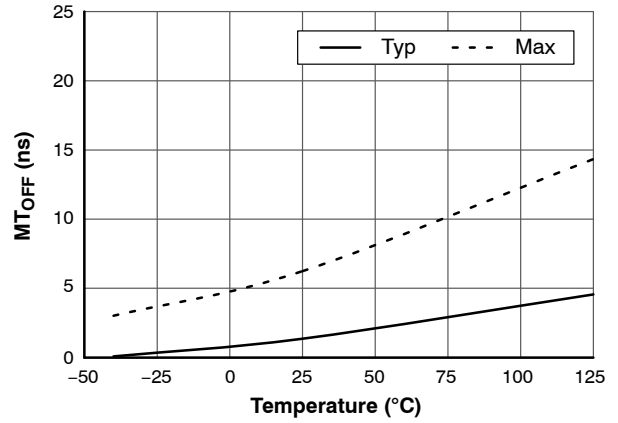

Figure 31. Delay Matching HO and LO Turn-off vs. Temperature

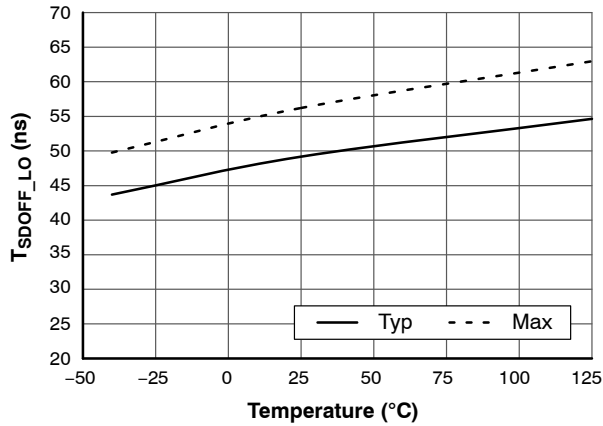

Figure 32.  $\overline{SD}$  to Low-side Propagation Delay vs. Temperature

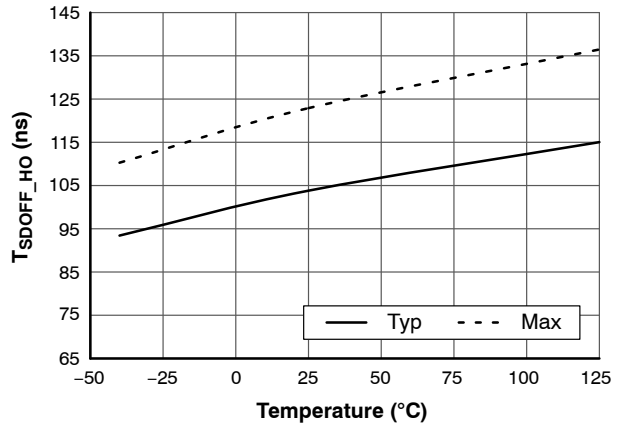

Figure 33.  $\overline{SD}$  to High-side Propagation Delay vs. Temperature

TYPICAL CHARACTERISTICS (Continued)

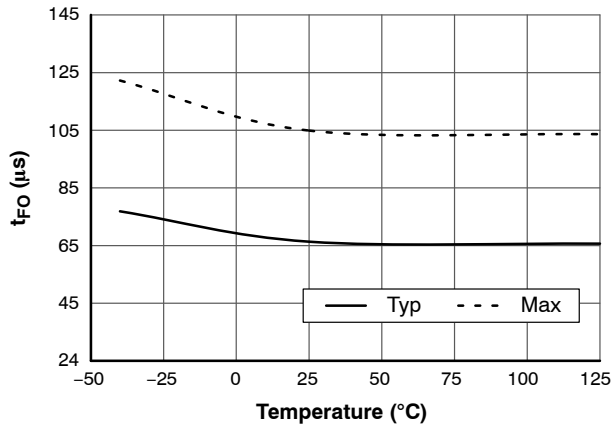

Figure 34. Fault Output Minimum Pulse Width vs. Temperature

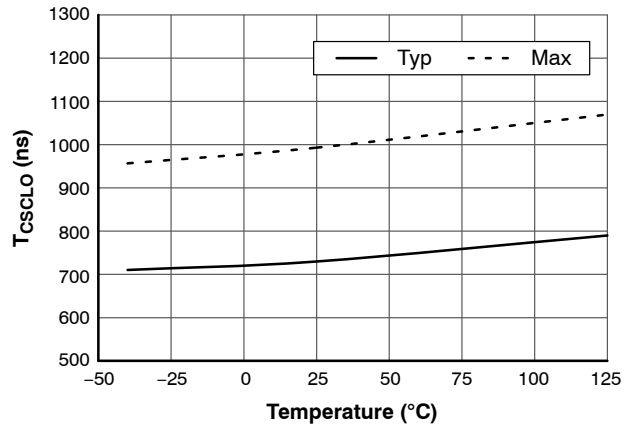

Figure 35. Time from CSC Triggering to Low-side Gate Output vs. Temperature

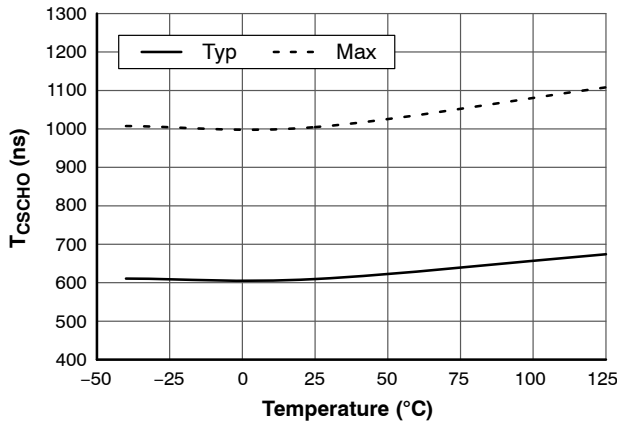

Figure 36. Time from CSC Triggering to High-side Gate Output vs. Temperature

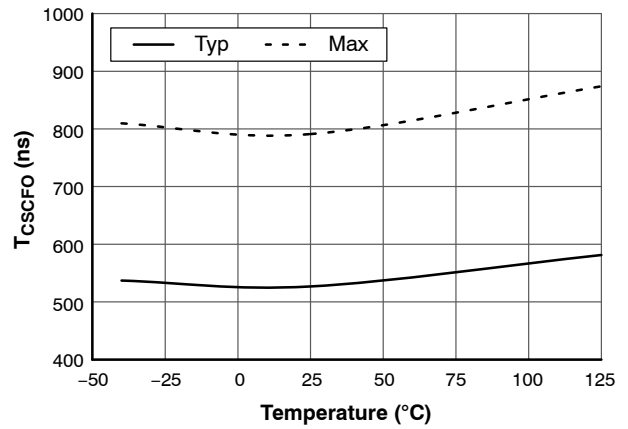

Figure 37. Time from CSC Triggering to FO vs. Temperature

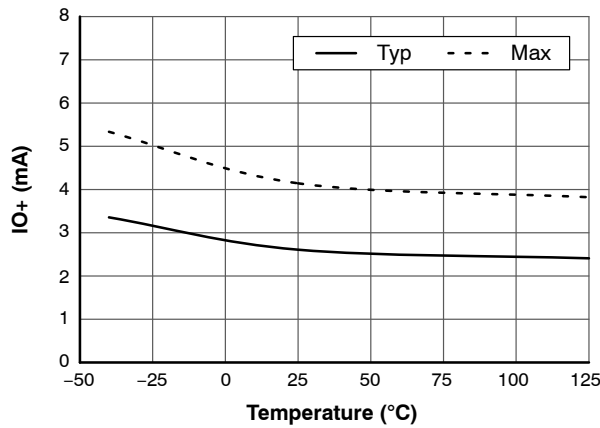

Figure 38. Output High Short-circuit Pulsed Current vs. Temperature

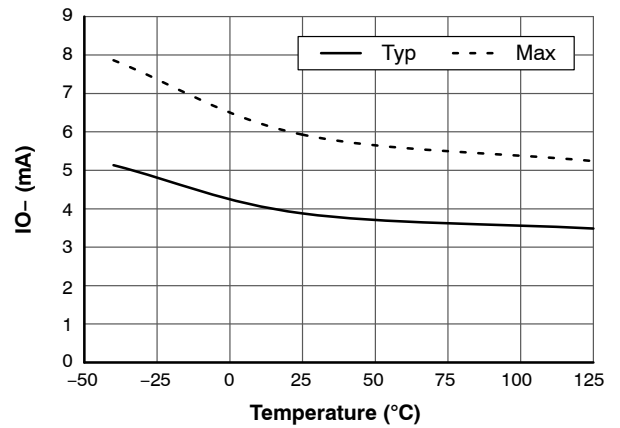

Figure 39. Output Low Short-circuit Pulsed Current vs. Temperature

SWITCHING TIME DEFINITIONS

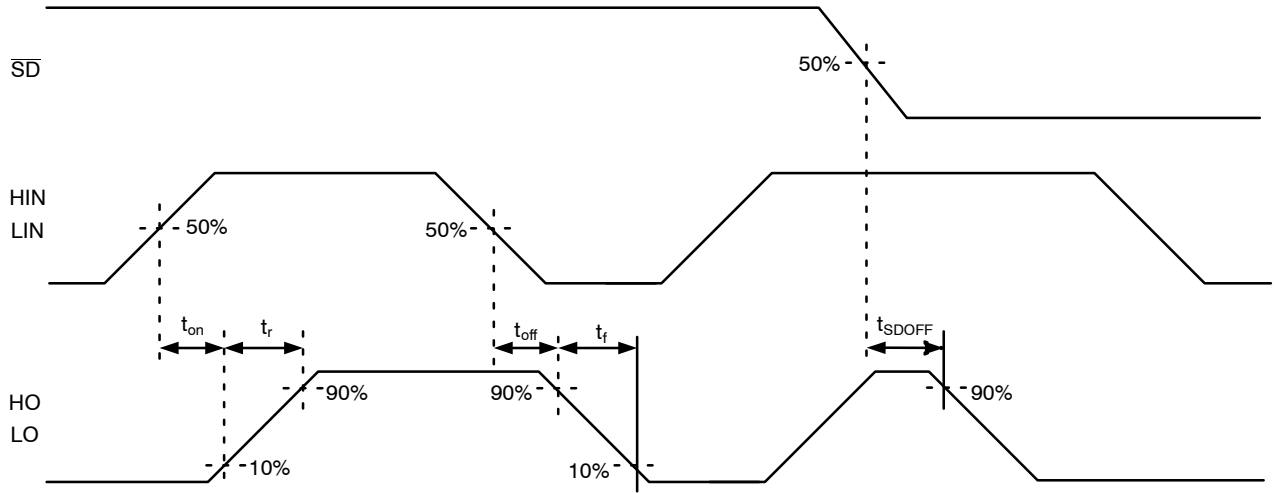

Figure 40. Switching Timing Waveforms Definition (Propagation Delay, Rise and Fall Time)

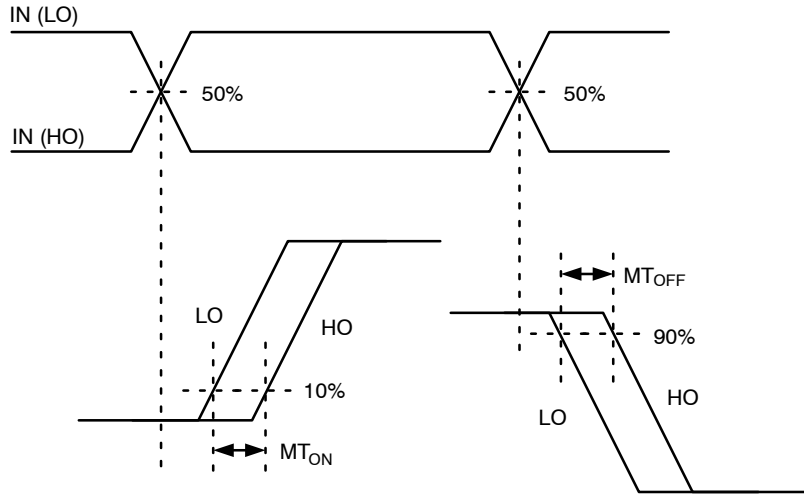
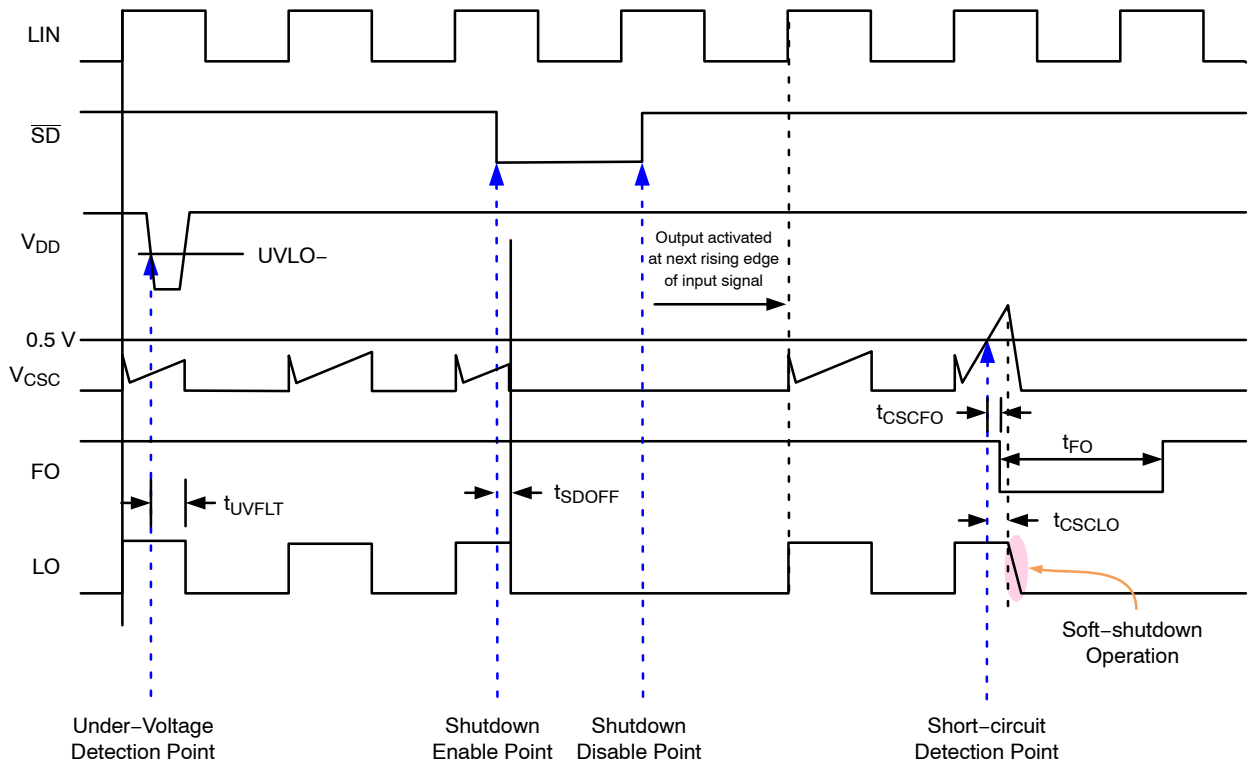
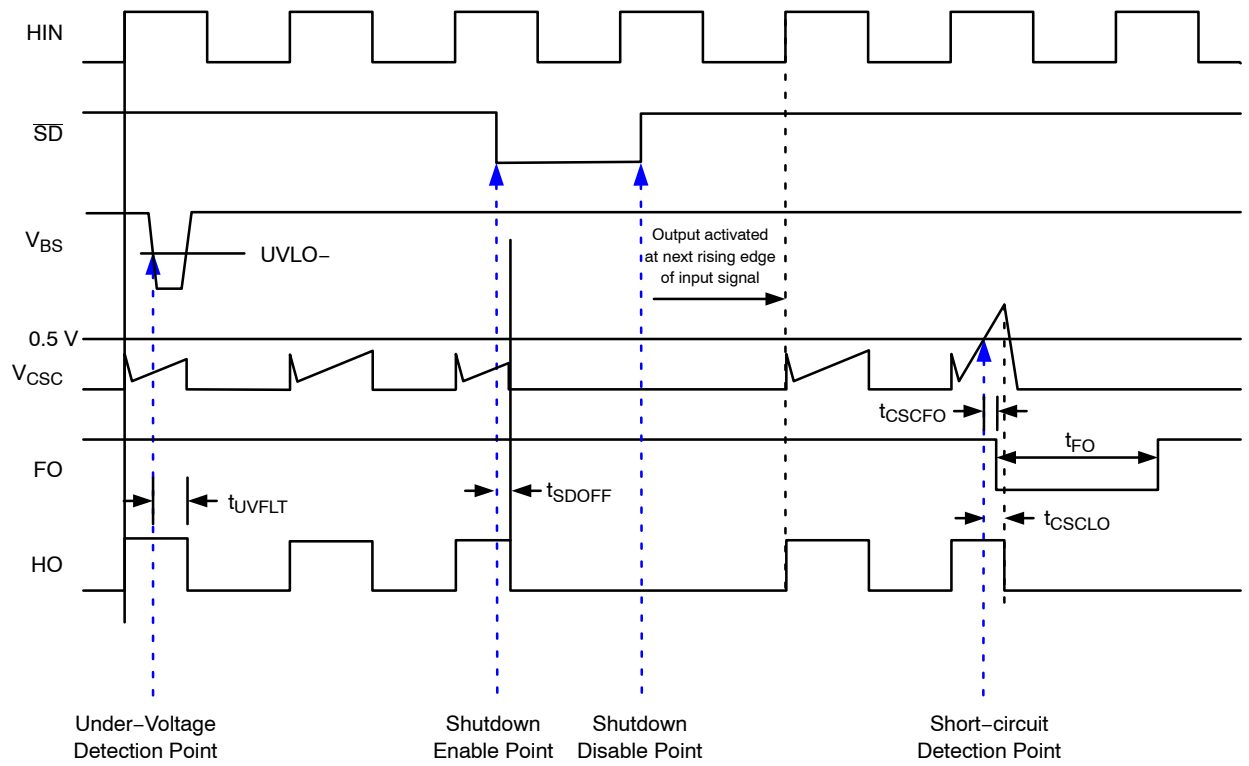

Figure 41. Switching Timing Waveforms Definition (Matching Delay)

# FAD8253MX-1



**Figure 42. Switching Timing Waveforms Definition – Low Side**



**Figure 43. Switching Timing Waveforms Definition – High Side**

APPLICATIONS INFORMATION

Protection Function

Shutdown ( $\overline{SD}$ ) Function

The shutdown ( $\overline{SD}$ ) pin of FAD8253 is active low, meaning that the driver outputs are enabled when  $\overline{SD}$  pin is pulled up and vice versa. If  $\overline{SD}$  pin is pulled low for a time equivalent to propagation delay, the outputs of both high and low side driver stages are turned off. The outputs are reactivated on the next rising edge of the input signal, once the  $\overline{SD}$  pin is pulled up.

Under-Voltage Lockout (UVLO)

The FAD8253 has an internal under-voltage lockout (UVLO) protection circuitry for both high-side and low-side driver stages, with a threshold optimized for IGBTs. The UVLO independently monitors the supply voltage ( $V_{DD}$ ) and bootstrap capacitor voltage ( $V_{BS}$ ) to prevent malfunction if  $V_{DD}$  and  $V_{BS}$  drop lower than the specified threshold voltage in the manner explained below:

- If  $V_{BS}$  drops below its negative-going threshold voltage, the output of the high side driver stage is pulled down (or turned off).
- If  $V_{DD}$  voltage drops below its negative-going threshold voltage, the outputs of both the low side and high side driver stages are pulled down (or turned off).

In either of the above cases, the outputs will resume their normal operation once the  $V_{BS}/V_{DD}$  voltages have risen back to the necessary positive going threshold, as shown in Figure 44. Moreover, the UVLO hysteresis and the UV filtering time prevent chattering during power supply transitions. If the supply voltage ( $V_{DD}$  or  $V_{BS}$ ) maintains an under-voltage condition for a duration longer than the under-voltage filtering time, the high and low side driver outputs are turned off. Note that an UVLO event has no impact to the Fault Output flag.

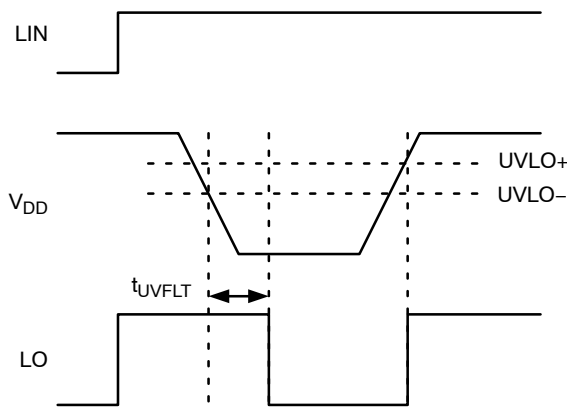

Figure 44. Waveforms for Under-Voltage Lockout

Shoot-Through Prevention Function

The FAD8253 has a shoot-through prevention circuitry that monitors both the high-side and low-side inputs. It is

designed to prevent the outputs of the high-side and low-side stages from turning on at the same time.

As shown in Figure 45, if the low-side input (LIN) signal is provided to the driver while the high-side input (HIN) signal is already present, the high side output (HO) is turned off immediately while the low-side output (LO) is kept turned off. In addition, both driver outputs are kept turned off for as long as both HIN and LIN are present. This prevents the shoot-through of the high-side and low-side devices in an application. Similarly, as shown in Figure 46, if HIN signal is provided to the driver while LIN signal is already present, LO is turned off immediately while HO is kept turned off.

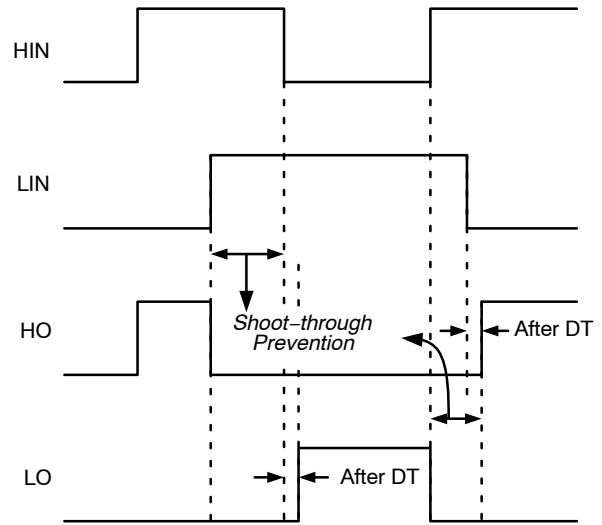

Figure 45. Example Waveforms for Shoot-through Prevention

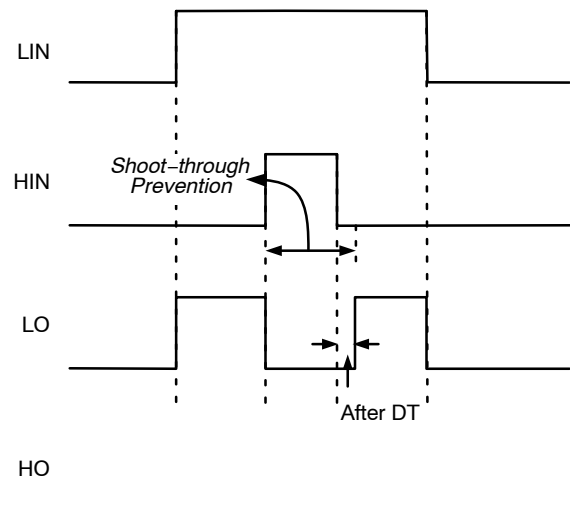

Figure 46. Example waveforms for Shoot-through Prevention

Please note that the driver resumes normal operation with a built-in dead time of 120 ns (typ.) between HO and LO, only when LIN and HIN signals are not provided at the same time.

**Over-Current/Short-Circuit Protection Function**

The FAD8253 has a low side over-current detection circuitry that monitors the voltage across the low side current sensing resistor ( $R_{CSR}$ ) through the short-circuit current detection input (CSC) pin.

The input stage of the over current circuitry is depicted in Figure 47. The principle of overcurrent/short-circuit detection feature is to monitor the voltage at point A (which appears due to the phase current flowing into  $R_{CSR}$ ). If the sensed voltage exceeds the short-circuit detector reference voltage  $V_{CSCREF}$  (typ. 0.5 V), this indicates an over-current condition and the driver outputs are turned off.

For example, if  $R_{CSC} = 1\text{ m}\Omega$ , the driver will activate the short circuit protection for a phase current exceeding 500 A ( $1\text{ m}\Omega \times 500\text{ A} = 0.5\text{ V} \geq V_{CSCREF}$ ).

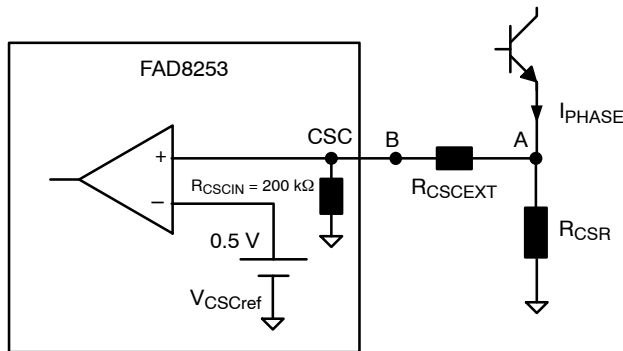

**Figure 47. Input Circuit of the Overcurrent/Short-circuit Protection Block**

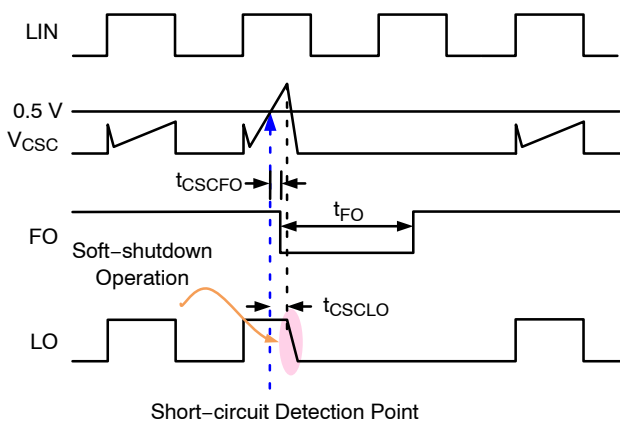

**Figure 48. Waveforms for Short Circuit Protection**

It is recommended to place a series resistance  $R_{CSCEXT}$  to limit the input current that may flow into the driver during transient conditions. Note that  $R_{CSCEXT}$  and  $R_{CSCIN}$  form

a voltage divider that could lower the voltage at the CSC pin (at point B in Figure 47). To minimize the voltage difference, a value of 1 kΩ is recommended for  $R_{CSCEXT}$ . As a result, the voltage at point B (or CSC pin) will be  $R_{CSCEXT} / (R_{CSCEXT} + R_{CSCIN}) = 200\text{ k}\Omega / (200\text{ k}\Omega + 1\text{ k}\Omega)$ , which is only 0.5% lower than at point A.

An over-current condition must last for a minimum duration of  $t_{CSCFLT}$  (typ. 300 ns) to trigger the short-circuit protection. This duration has been defined to provide adequate noise filtering against high frequency noises during IGBT switching. If this time is not sufficient, an additional capacitor can be placed at the input of the CSC pin to further extend the filtering time.

Upon detection of a short circuit through the CSC pin:

- the high side output turns off immediately;
- the low side driver output initiates a soft shutdown to turn off the low side IGBT slowly to prevent it from entering the avalanche mode;
- the Fault Output (FO) pin generates a fault signal for a duration of  $t_{FO}$  (typ. 60 μs).

Please note that once the FO is triggered, the driver outputs can be reactivated on the next rising edge of input signal only after the duration of  $t_{FO}$  has passed.

**Layout Considerations**

For optimum performance, considerations must be taken during printed circuit board (PCB) layout.

**Power Supply Bypass Capacitors**

The implementation of bypass capacitors is essential to optimal operation of gate drivers like FAD8253 and so, special attention is required.

The local bypass capacitor between  $V_{DD}$  and  $V_{SS}$  needs to provide pulsed currents for the low side driver output. At the same time, if a high-side bootstrap circuit is employed, it has to rapidly charge the bootstrap capacitor as well.

A typical criterion for choosing the value of bypass capacitor is to keep the ripple voltage on the supply pin to  $\leq 5\%$ . Typically, two capacitors in parallel are recommended. Often, a capacitor of smaller value is placed very close to the  $V_{DD}$  pin in parallel with another capacitor of higher value to reduce impedance. For sizing of the bootstrap capacitor please refer to application note [AN-6076](#).

**Gate-Drive Loop**

Current loops behave like antennae, able to receive and transmit noise. To reduce the noise coupling/emission and improve the power switch turn-on and off performance, gate-drive loops must be reduced as much as possible.

**Ground Plane**

To minimize noise coupling, the ground plane should not be placed under or near the high voltage floating side.



# MECHANICAL CASE OUTLINE PACKAGE DIMENSIONS



SCALE 1:1

SOIC-14 NB  
CASE 751A-03  
ISSUE L

DATE 03 FEB 2016

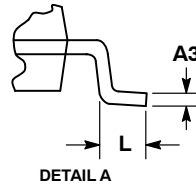

- NOTES:
1. DIMENSIONING AND TOLERANCING PER ASME Y14.5M, 1994.
  2. CONTROLLING DIMENSION: MILLIMETERS.
  3. DIMENSION b DOES NOT INCLUDE DAMBAR PROTRUSION. ALLOWABLE PROTRUSION SHALL BE 0.13 TOTAL IN EXCESS OF AT MAXIMUM MATERIAL CONDITION.
  4. DIMENSIONS D AND E DO NOT INCLUDE MOLD PROTRUSIONS.
  5. MAXIMUM MOLD PROTRUSION 0.15 PER SIDE.

DIM	MILLIMETERS		INCHES	
	MIN	MAX	MIN	MAX
A	1.35	1.75	0.054	0.068
A1	0.10	0.25	0.004	0.010
A3	0.19	0.25	0.008	0.010
b	0.35	0.49	0.014	0.019
D	8.55	8.75	0.337	0.344
E	3.80	4.00	0.150	0.157
e	1.27 BSC		0.050 BSC	
H	5.80	6.20	0.228	0.244
h	0.25	0.50	0.010	0.019
L	0.40	1.25	0.016	0.049
M	0°	7°	0°	7°

### SOLDERING FOOTPRINT\*

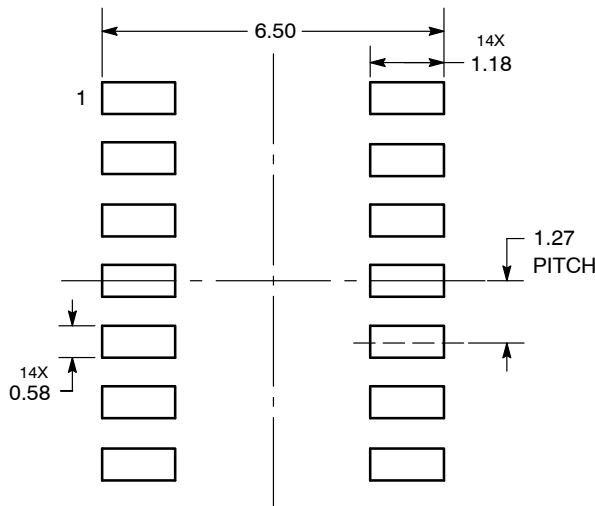

DIMENSIONS: MILLIMETERS

\*For additional information on our Pb-Free strategy and soldering details, please download the ON Semiconductor Soldering and Mounting Techniques Reference Manual, SOLDERRM/D.

### GENERIC MARKING DIAGRAM\*

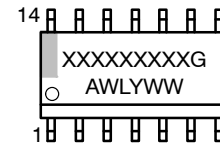

- XXXXXX = Specific Device Code
- A = Assembly Location
- WL = Wafer Lot
- Y = Year
- WW = Work Week
- G = Pb-Free Package

\*This information is generic. Please refer to device data sheet for actual part marking. Pb-Free indicator, "G" or microdot "▪", may or may not be present. Some products may not follow the Generic Marking.

STYLES ON PAGE 2

DOCUMENT NUMBER:	98ASB42565B	Electronic versions are uncontrolled except when accessed directly from the Document Repository. Printed versions are uncontrolled except when stamped "CONTROLLED COPY" in red.
DESCRIPTION:	SOIC-14 NB	PAGE 1 OF 2

onsemi and ONSEMI are trademarks of Semiconductor Components Industries, LLC dba onsemi or its subsidiaries in the United States and/or other countries. onsemi reserves the right to make changes without further notice to any products herein. onsemi makes no warranty, representation or guarantee regarding the suitability of its products for any particular purpose, nor does onsemi assume any liability arising out of the application or use of any product or circuit, and specifically disclaims any and all liability, including without limitation special, consequential or incidental damages. onsemi does not convey any license under its patent rights nor the rights of others.

**SOIC-14**  
**CASE 751A-03**  
**ISSUE L**

DATE 03 FEB 2016

STYLE 1:  
 PIN 1. COMMON CATHODE  
 2. ANODE/CATHODE  
 3. ANODE/CATHODE  
 4. NO CONNECTION  
 5. ANODE/CATHODE  
 6. NO CONNECTION  
 7. ANODE/CATHODE  
 8. ANODE/CATHODE  
 9. ANODE/CATHODE  
 10. NO CONNECTION  
 11. ANODE/CATHODE  
 12. ANODE/CATHODE  
 13. NO CONNECTION  
 14. COMMON ANODE

STYLE 2:  
 CANCELLED

STYLE 3:  
 PIN 1. NO CONNECTION  
 2. ANODE  
 3. ANODE  
 4. NO CONNECTION  
 5. ANODE  
 6. NO CONNECTION  
 7. ANODE  
 8. ANODE  
 9. ANODE  
 10. NO CONNECTION  
 11. ANODE  
 12. ANODE  
 13. NO CONNECTION  
 14. COMMON CATHODE

STYLE 4:  
 PIN 1. NO CONNECTION  
 2. CATHODE  
 3. CATHODE  
 4. NO CONNECTION  
 5. CATHODE  
 6. NO CONNECTION  
 7. CATHODE  
 8. CATHODE  
 9. CATHODE  
 10. NO CONNECTION  
 11. CATHODE  
 12. CATHODE  
 13. NO CONNECTION  
 14. COMMON ANODE

STYLE 5:  
 PIN 1. COMMON CATHODE  
 2. ANODE/CATHODE  
 3. ANODE/CATHODE  
 4. ANODE/CATHODE  
 5. ANODE/CATHODE  
 6. NO CONNECTION  
 7. COMMON ANODE  
 8. COMMON CATHODE  
 9. ANODE/CATHODE  
 10. ANODE/CATHODE  
 11. ANODE/CATHODE  
 12. ANODE/CATHODE  
 13. NO CONNECTION  
 14. COMMON ANODE

STYLE 6:  
 PIN 1. CATHODE  
 2. CATHODE  
 3. CATHODE  
 4. CATHODE  
 5. CATHODE  
 6. CATHODE  
 7. CATHODE  
 8. ANODE  
 9. ANODE  
 10. ANODE  
 11. ANODE  
 12. ANODE  
 13. ANODE  
 14. ANODE

STYLE 7:  
 PIN 1. ANODE/CATHODE  
 2. COMMON ANODE  
 3. COMMON CATHODE  
 4. ANODE/CATHODE  
 5. ANODE/CATHODE  
 6. ANODE/CATHODE  
 7. ANODE/CATHODE  
 8. ANODE/CATHODE  
 9. ANODE/CATHODE  
 10. ANODE/CATHODE  
 11. COMMON CATHODE  
 12. COMMON ANODE  
 13. ANODE/CATHODE  
 14. ANODE/CATHODE

STYLE 8:  
 PIN 1. COMMON CATHODE  
 2. ANODE/CATHODE  
 3. ANODE/CATHODE  
 4. NO CONNECTION  
 5. ANODE/CATHODE  
 6. ANODE/CATHODE  
 7. COMMON ANODE  
 8. COMMON ANODE  
 9. ANODE/CATHODE  
 10. ANODE/CATHODE  
 11. NO CONNECTION  
 12. ANODE/CATHODE  
 13. ANODE/CATHODE  
 14. COMMON CATHODE

<b>DOCUMENT NUMBER:</b>	<b>98ASB42565B</b>	Electronic versions are uncontrolled except when accessed directly from the Document Repository. Printed versions are uncontrolled except when stamped "CONTROLLED COPY" in red.
<b>DESCRIPTION:</b>	<b>SOIC-14 NB</b>	<b>PAGE 2 OF 2</b>

**onsemi** and **ONSEMI** are trademarks of Semiconductor Components Industries, LLC dba **onsemi** or its subsidiaries in the United States and/or other countries. **onsemi** reserves the right to make changes without further notice to any products herein. **onsemi** makes no warranty, representation or guarantee regarding the suitability of its products for any particular purpose, nor does **onsemi** assume any liability arising out of the application or use of any product or circuit, and specifically disclaims any and all liability, including without limitation special, consequential or incidental damages. **onsemi** does not convey any license under its patent rights nor the rights of others.

**onsemi**, **Onsemi**, and other names, marks, and brands are registered and/or common law trademarks of Semiconductor Components Industries, LLC dba "**onsemi**" or its affiliates and/or subsidiaries in the United States and/or other countries. **onsemi** owns the rights to a number of patents, trademarks, copyrights, trade secrets, and other intellectual property. A listing of **onsemi**'s product/patent coverage may be accessed at [www.onsemi.com/site/pdf/Patent-Marking.pdf](http://www.onsemi.com/site/pdf/Patent-Marking.pdf). **onsemi** reserves the right to make changes at any time to any products or information herein, without notice. The information herein is provided "as-is" and **onsemi** makes no warranty, representation or guarantee regarding the accuracy of the information, product features, availability, functionality, or suitability of its products for any particular purpose, nor does **onsemi** assume any liability arising out of the application or use of any product or circuit, and specifically disclaims any and all liability, including without limitation special, consequential or incidental damages. Buyer is responsible for its products and applications using **onsemi** products, including compliance with all laws, regulations and safety requirements or standards, regardless of any support or applications information provided by **onsemi**. "Typical" parameters which may be provided in **onsemi** data sheets and/or specifications can and do vary in different applications and actual performance may vary over time. All operating parameters, including "Typicals" must be validated for each customer application by customer's technical experts. **onsemi** does not convey any license under any of its intellectual property rights nor the rights of others. **onsemi** products are not designed, intended, or authorized for use as a critical component in life support systems or any FDA Class 3 medical devices or medical devices with a same or similar classification in a foreign jurisdiction or any devices intended for implantation in the human body. Should Buyer purchase or use **onsemi** products for any such unintended or unauthorized application, Buyer shall indemnify and hold **onsemi** and its officers, employees, subsidiaries, affiliates, and distributors harmless against all claims, costs, damages, and expenses, and reasonable attorney fees arising out of, directly or indirectly, any claim of personal injury or death associated with such unintended or unauthorized use, even if such claim alleges that **onsemi** was negligent regarding the design or manufacture of the part. **onsemi** is an Equal Opportunity/Affirmative Action Employer. This literature is subject to all applicable copyright laws and is not for resale in any manner.

## PUBLICATION ORDERING INFORMATION

### LITERATURE FULFILLMENT:

Email Requests to: [orderlit@onsemi.com](mailto:orderlit@onsemi.com)

**onsemi Website:** [www.onsemi.com](http://www.onsemi.com)

### TECHNICAL SUPPORT

**North American Technical Support:**

Voice Mail: 1 800-282-9855 Toll Free USA/Canada

Phone: 011 421 33 790 2910

**Europe, Middle East and Africa Technical Support:**

Phone: 00421 33 790 2910

For additional information, please contact your local Sales Representative