

FLARE-MINI-A

~100° x 20° oval beam. Assembly with installation tape.

TECHNICAL SPECIFICATIONS:

Dimensions	Ø 16.0 mm
Height	9.1 mm
Fastening	tape
Colour	clear
Box size	
Box weight	6.7 kg
Quantity in Box	4600 pcs
ROHS compliant	yes ⓘ



MATERIAL SPECIFICATIONS:

Component	Type	Material	Colour
FLARE-MINI-A	Single lens	PMMA	clear
TINA-TAPE3	Tape	PU tape	black

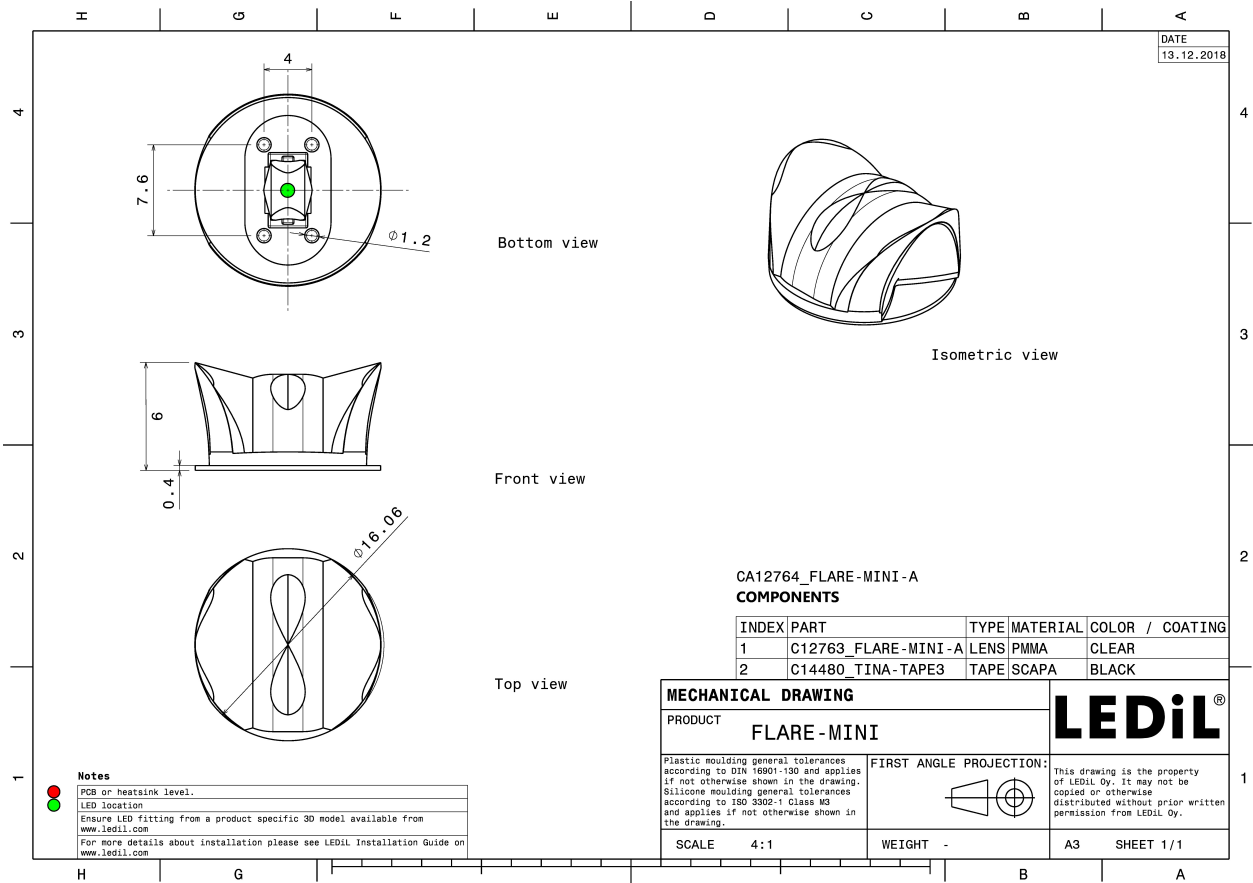

PHOTOMETRIC DATA (MEASURED):

CREE

LED XB-D
 FWHM 130.0 + 21.0°
 Efficiency 94 %
 Peak intensity 0.800 cd/lm
 LEDs/each optic 1
 Light colour White
 Required components:

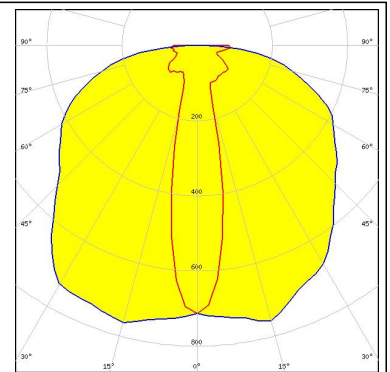
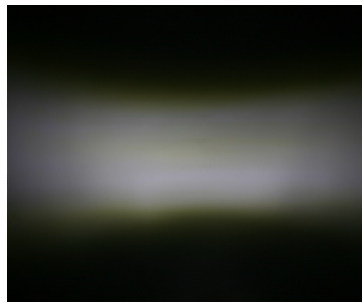

CREE

LED XP-E
 FWHM 113.0 + 20.0°
 Efficiency 94 %
 Peak intensity 0.900 cd/lm
 LEDs/each optic 1
 Light colour White
 Required components:

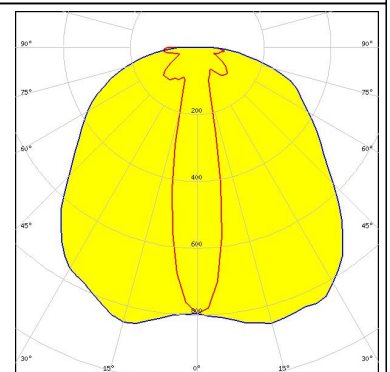
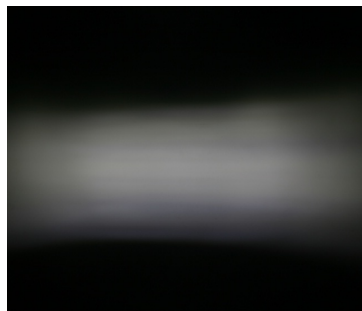

CREE

LED XP-E2
 FWHM 92.0 + 12.0°
 Efficiency 94 %
 Peak intensity 2.000 cd/lm
 LEDs/each optic 1
 Light colour White
 Required components:

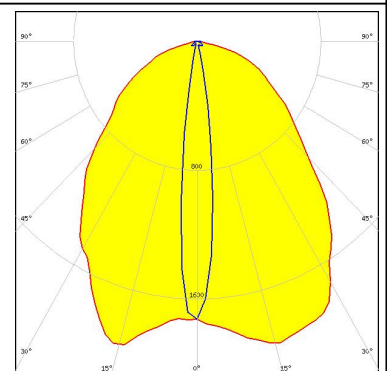
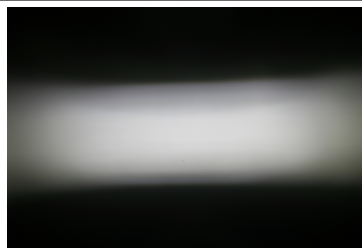

CREE

LED XP-G
 FWHM 114.0 + 22.0°
 Efficiency 94 %
 Peak intensity 0.800 cd/lm
 LEDs/each optic 1
 Light colour White
 Required components:

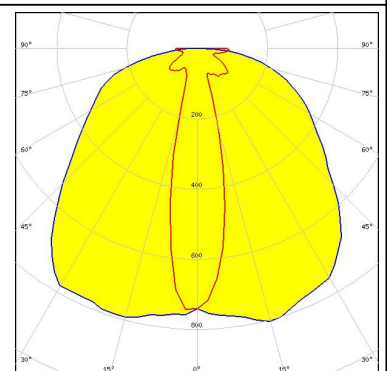
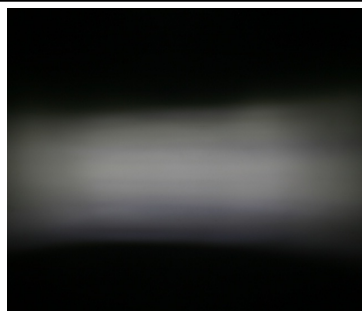

PHOTOMETRIC DATA (MEASURED):

CREE

LED XP-G2
 FWHM 94.0 + 19.0°
 Efficiency 94 %
 Peak intensity 1.300 cd/lm
 LEDs/each optic 1
 Light colour White
 Required components:

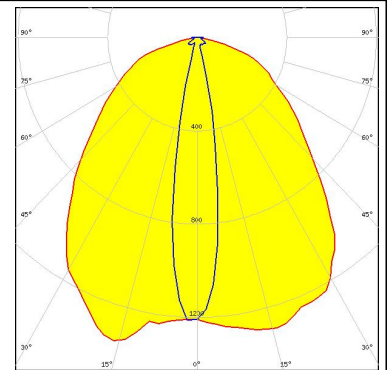

CREE

LED XP-L HD
 FWHM 114.0 + 25.0°
 Efficiency 91 %
 Peak intensity 0.790 cd/lm
 LEDs/each optic 1
 Light colour White
 Required components:

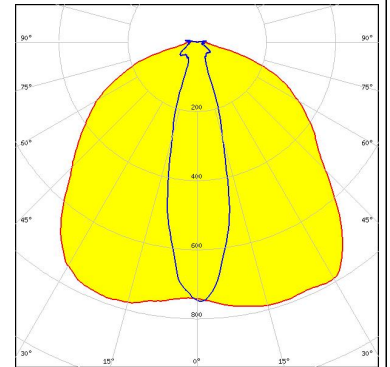
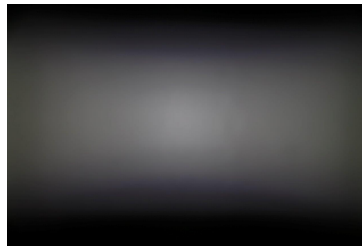

CREE

LED XP-L2
 FWHM 100.0 + 28.0°
 Efficiency 94 %
 Peak intensity 0.840 cd/lm
 LEDs/each optic 1
 Light colour White
 Required components:

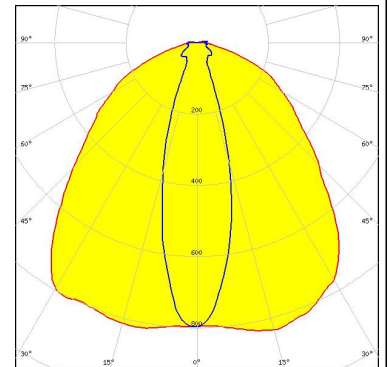
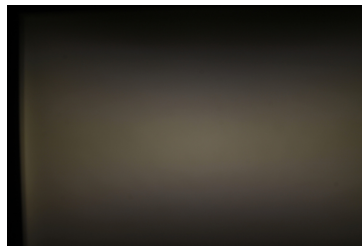

CREE

LED XT-E
 FWHM 124.0 + 22.0°
 Efficiency 94 %
 Peak intensity 0.700 cd/lm
 LEDs/each optic 1
 Light colour White
 Required components:

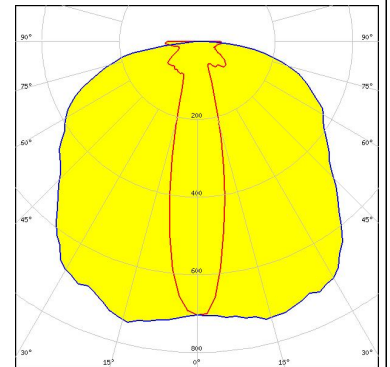
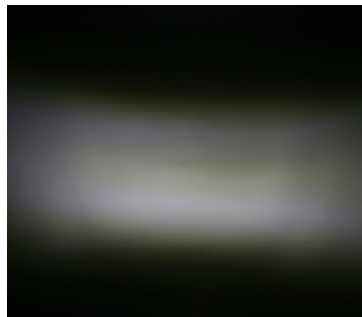

PHOTOMETRIC DATA (MEASURED):

LG Innotek

LED H35C1 (LEMWA33)
FWHM 96.0 + 18.0°
Efficiency 94 %
Peak intensity 1.320 cd/lm
LEDs/each optic 1
Light colour White
Required components:

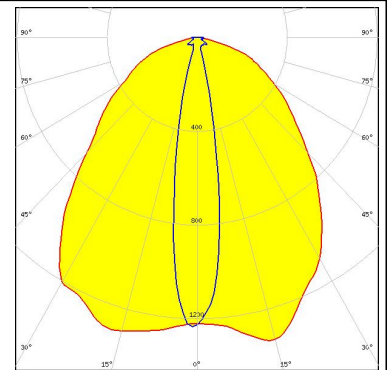
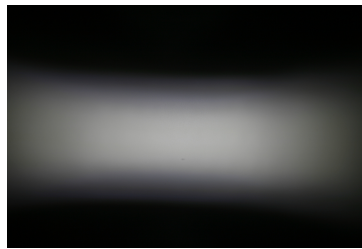

LUMILEDS

LED LUXEON Rebel ES
FWHM 110.0 + 19.0°
Efficiency 94 %
Peak intensity 0.900 cd/lm
LEDs/each optic 1
Light colour White
Required components:

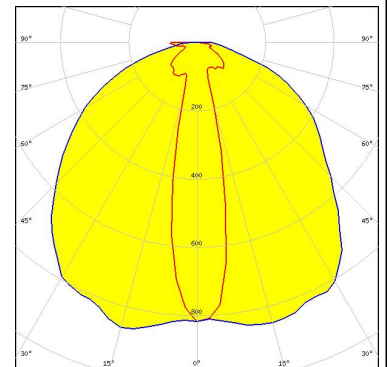

NICHIA

LED NCSxx19A
FWHM 112.0 + 20.0°
Efficiency 94 %
Peak intensity 0.900 cd/lm
LEDs/each optic 1
Light colour White
Required components:

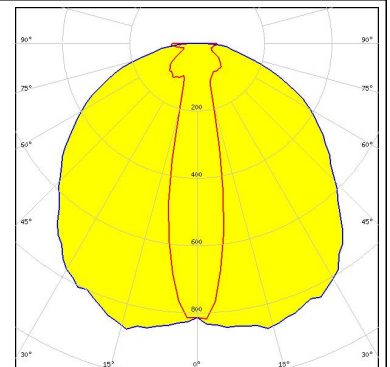
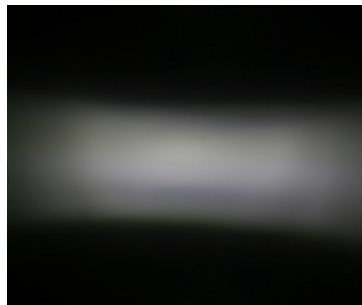

NICHIA

LED NCSxx19B
FWHM 95.0 + 15.0°
Efficiency 94 %
Peak intensity 1.600 cd/lm
LEDs/each optic 1
Light colour White
Required components:

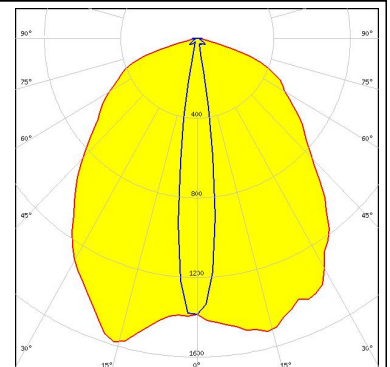

PHOTOMETRIC DATA (MEASURED):

OSRAM

Opto Semiconductors

LED Oslon Square PC
 FWHM 116.0 + 22.0°
 Efficiency 94 %
 Peak intensity 0.800 cd/lm
 LEDs/each optic 1
 Light colour White
 Required components:

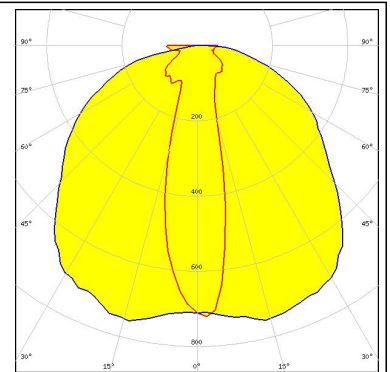
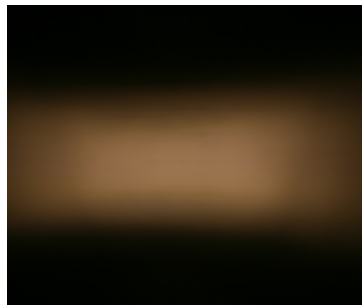

OSRAM

Opto Semiconductors

LED Oslon SSL 150
 FWHM 106.0 + 11.0°
 Efficiency 93 %
 Peak intensity 1.700 cd/lm
 LEDs/each optic 1
 Light colour White
 Required components:

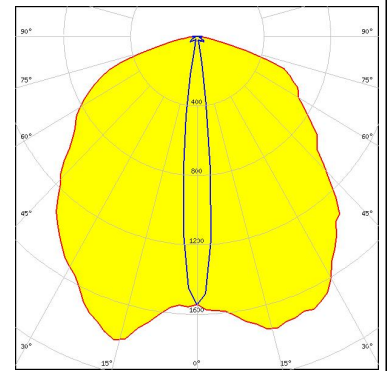

OSRAM

Opto Semiconductors

LED Oslon SSL 80
 FWHM 84.0 + 12.0°
 Efficiency 93 %
 Peak intensity 2.000 cd/lm
 LEDs/each optic 1
 Light colour White
 Required components:

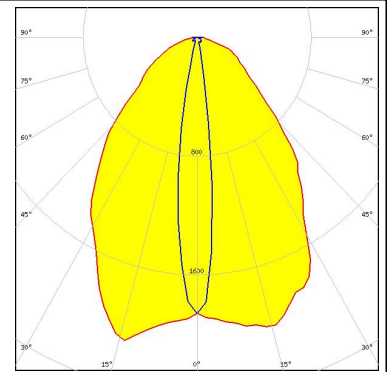
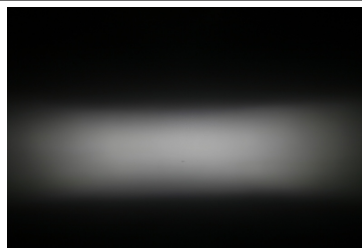

SAMSUNG

LED LH351Z
 FWHM 95.0 + 19.0°
 Efficiency 94 %
 Peak intensity 1.500 cd/lm
 LEDs/each optic 1
 Light colour White
 Required components:

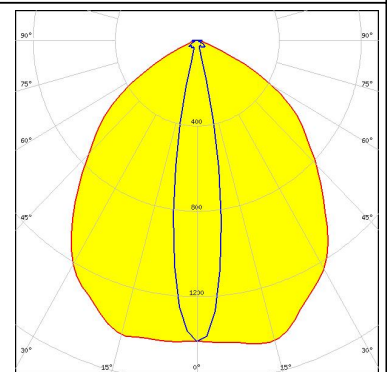
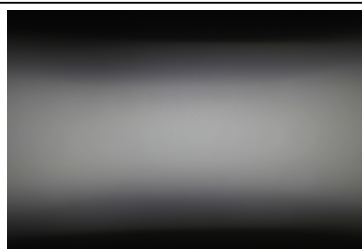

PHOTOMETRIC DATA (MEASURED):

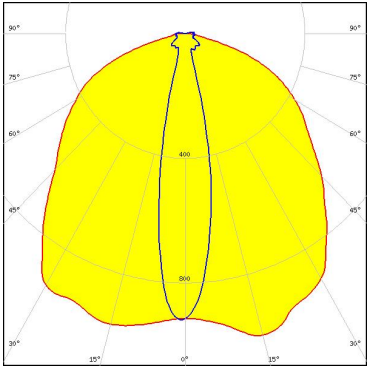
 SEOUL SEMICONDUCTOR			
LED	Z8Y22P		
FWHM	115.0 + 21.0°		
Efficiency	94 %		
Peak intensity	1.000 cd/m		
LEDs/each optic	1		
Light colour	White		
Required components:			

PHOTOMETRIC DATA (SIMULATED):



LED XHP35 HD
FWHM 31.0 + 96.0°
Efficiency 93 %
Peak intensity 0.890 cd/lm
LEDs/each optic 1
Light colour White
Required components:

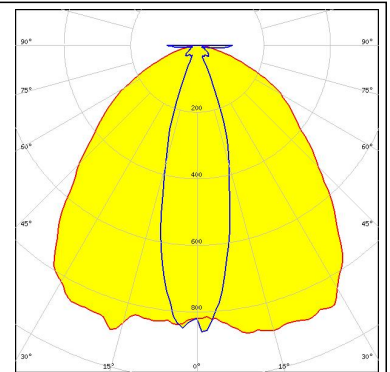

LED XHP35 HI
FWHM 20.0 + 92.0°
Efficiency 94 %
Peak intensity 1.300 cd/lm
LEDs/each optic 1
Light colour White
Required components:

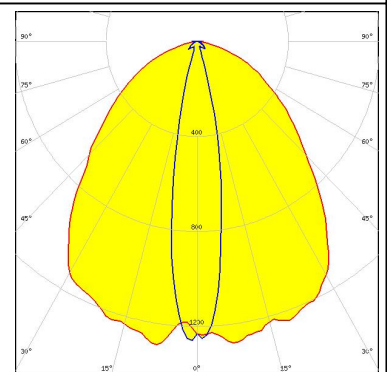

LED LUXEON C
FWHM 11.0 + 84.0°
Efficiency 92 %
Peak intensity 1.600 cd/lm
LEDs/each optic 1
Light colour White
Required components:

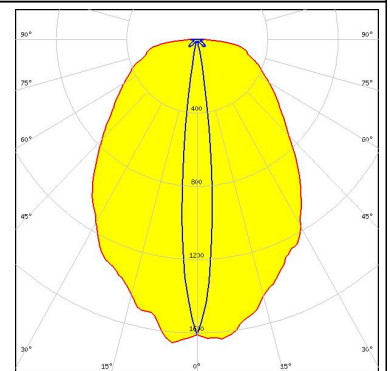

GENERAL INFORMATION:

NOTE: The typical beam angle will be changed by different color, chip size and chip position tolerance. The typical total beam angle is the full angle measured where the luminous intensity is half of the peak value.

MATERIALS:

As part of our continuous research and improvement processes, and to ensure the best possible quality and availability of our products, LEDiL reserves the right to change material grades without notice.

PRODUCT DATA USER AGREEMENT AND DISCLAIMER:

The measured data in the provided downloadable LEDiL Product Datasheets and Mechanical 2D-Drawings is rounded and provided as reference for planning. LEDiL Oy's optical specifications have been verified by conducting performance testing of the products in accordance with the company's quality system. The reported data are averaged results of multiple measurements with typical variation. LEDiL Oy reserves the right to without prior notification make changes and improvements to its products.

LEDiL Oy assumes neither warranty, nor guarantee nor any other liability of any kind for the contents and correctness of the provided data. The provided data has been generated with highest diligence but the provided data may in reality not represent the complete possible variation range of all intrinsic parameters. Therefore, in certain cases a deviation from the provided data could occur.

LEDiL Oy reserves the right to undertake technical changes of its products without further notification which could lead to changes in the provided data. LEDiL Oy assumes no liability of any kind for the possible deviation from any provided data or any other damage resulting from the usage of the provided data.

The user agrees to this disclaimer and user agreement with the download or usage of the provided files.

LEDiL Oy

Joensuunkatu 13
FI-24240 SALO
Finland

LEDiL Inc.

228 West Page Street
Suite D
Sycamore IL 60178
USA

Local sales and technical support

[www.ledil.com/
where_to_buy](http://www.ledil.com/where_to_buy)

Shipping locations

Salo, Finland
Hong Kong, China

Distribution Partners

[www.ledil.com/
where_to_buy](http://www.ledil.com/where_to_buy)