

SUMMARY

Wires

Low voltage 8



Image is for illustrative purpose only

Series 1P
Termination type Female solder
IP rating 64
AWG wire size 0.00 - 0.00
Cable Ø 1.70 - 6.50 mm
Status active

Download

[Request a quote](#)

[Catalog](#)

TECHNICAL DETAILS

Mechanics

Shell Style/Model PN*: Fixed receptacle, nut fixing, watertight
Keying 1 key (alpha=0; Plug: male contact; Receptacle: female contact)
Housing Material PEI (Polyetherimide), gray
Variant A : Blue front nut
Weight 5.51 g

Performance

Configuration 1P.M08 : 8 Low Voltage
Insulator L: PEEK (UL 94 / V-0/1.5)
Rated Current 5 Amps

Specifications

Contact Type: Solder
Contact Dia.: 0.7 mm (0.0275in)
Bucket Dia.: 0.6 mm (0.024in)
Max. Solid Conductor: 0.14 mm² (AWG 26)
Max. Stranded Conductor: 0.14 mm² (AWG 26)
R (max): 6.5 mOhm
Test voltage (kV rms) Contact-contact: 1.05

LEMO products and services are provided "as is". LEMO makes no warranties or representations with regard to LEMO product & services or use of them, express, implied or statutory, including for accuracy, completeness, or security. The user is fully responsible for his products and applications using LEMO components.

Air clearance min.: 0.6 mm
Creepage distance min.: 0.6 mm

Others

Endurance (Shell): >2000 mating cycles
F ret (min): 50 N
F ret (max): 150 N
Steam sterilization: > 100 times (with potting on rear connection)

DRAWINGS

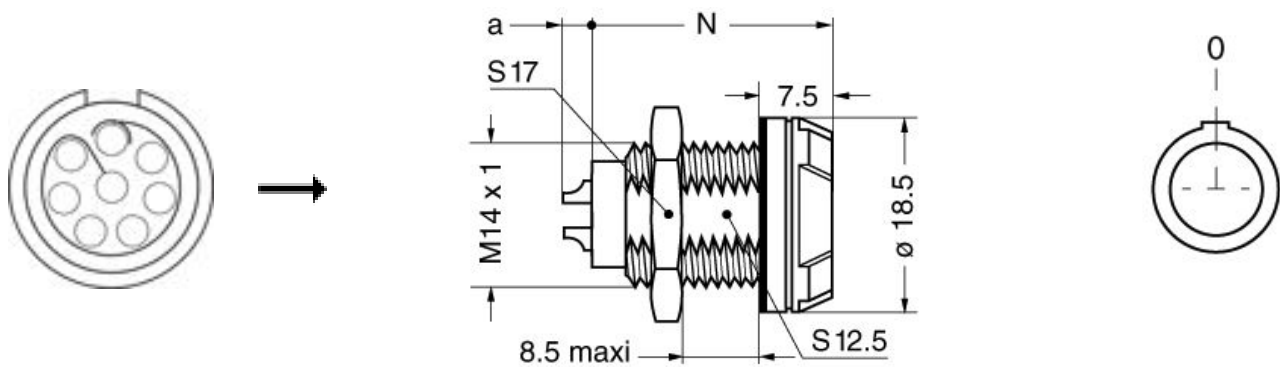

Dimensions











	N	a
mm.	23.3	2.5-4.5
in.	0,92	0,10

RECOMMENDED BY LEMO

Tools

Cables

LEMO products and services are provided "as is". LEMO makes no warranties or representations with regard to LEMO product & services or use of them, express, implied or statutory, including for accuracy, completeness, or security. The user is fully responsible for his products and applications using LEMO components.

CMN.08.T26.042QGZE	TPR (medical)	Grey	
108240	PTFE	White	
108260	PTFE	White	
16080	PVC	Grey	
180260	PVC	Black	
280250	PVC	Grey	
335990	PVC	Black	
335991	PVC	Black	
42265	PVC	Yellow	
80140	PVC	Grey	
8050	PVC	Black	
8280	PVC	Black	

LEMO products and services are provided "as is". LEMO makes no warranties or representations with regard to LEMO product & services or use of them, express, implied or statutory, including for accuracy, completeness, or security. The user is fully responsible for his products and applications using LEMO components.