

REV.	DESCRIPTION	DATE	APPROVED
A	Engineering Release	05/12/17	J. C.

*Length "X.X"	Tolerance
2.0" ~ 16.0"	±0.05"
16.1" ~ 40.0"	±0.15"
40.1" ~ 80.0"	±0.30"
80.1" ~ 500.0"	±0.5%

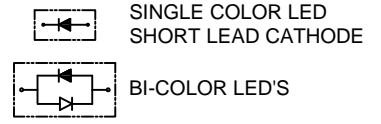

SHORT LEAD CATHODE	LED PART NO.	LONG LEAD CATHODE
RED	3SBCC-F	GREEN

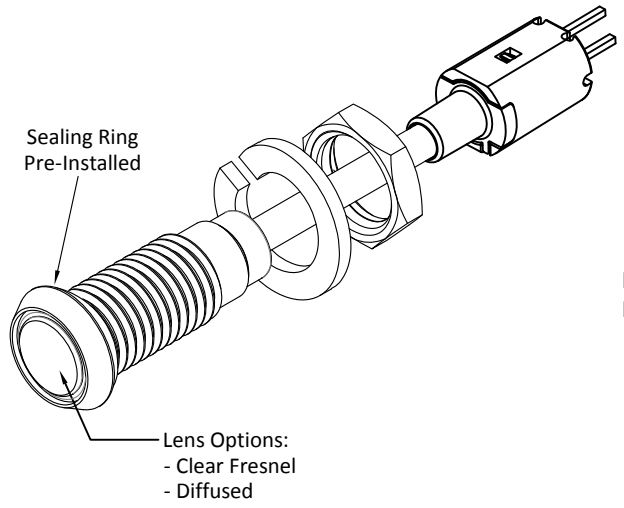
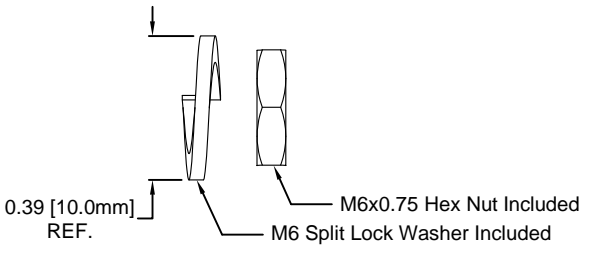
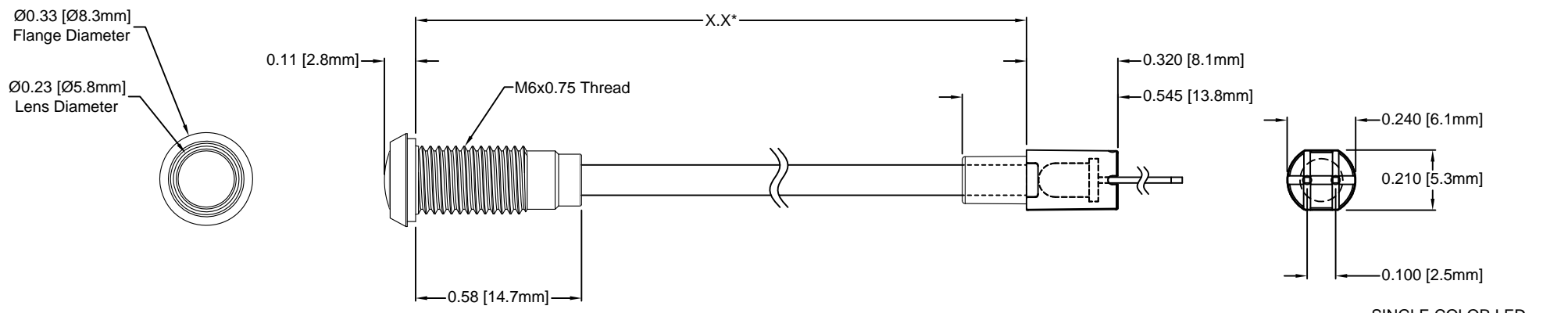
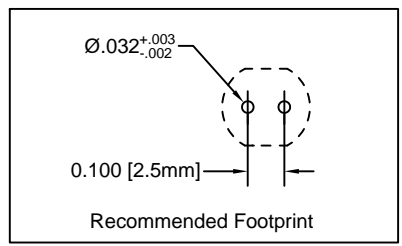
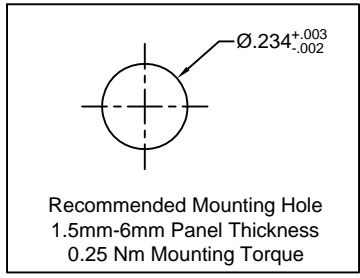

Lens Options:
 - Clear Fresnel
 - Diffused

Part Number Configuration
FV3-6.5-UR-F6PX67PR
 Lens Options:
 Z - Clear Fresnel
 D - Diffused
 LED Color, See Page 2
 Length in 0.1" Increments Only

- NOTES:**
1. SEALED TO IP67 RATING
 2. ROHS COMPLIANT
 3. MOUNTING HARDWARE AND ADAPTER SHIPPED NON-ASSEMBLED
 4. MINIMUM BEND RADIUS OF FLEXIBLE LIGHT PIPE: 1.06" [27mm]

STANDARD TOLERANCE (UNLESS OTHERWISE SPECIFIED)		 4 THOMAS, IRVINE, CA. 92618 TEL: (949) 951-8808 FAX: (949) 951-3974	
DECIMALS	ANGULAR		
.X ±.1	X° ± 1°	TITLE: IP67 RATED PANEL MOUNT FLP INDICATOR, VERTICAL PART NO: FV3-X.X-XXX-F6PX67PR CAGE CODE : 32559 SHEET # 1 OF 2 <small>CAD GENERATED DOCUMENT. DO NOT MEASURE DRAWING.</small>	
.XX ±.02			
.XXX ±.010			
DESIGNED: TD. Nguyen	DATE: 04/30/17	REVISION: A	
CHECKED: K. Baron	DATE: 04/30/17		

REV.	DESCRIPTION	DATE	APPROVED
	SEE SHEET #1		

Assy P/N	Emitted Color	Peak Wavelength λ_p (nm)	Absolute Max. Ratings			LED Electro-Optical Data @ 20mA			LED P/N
			Pd (mW)	If (mA)	Peak If (mA)	Vf (V)		LED Iv (mcd)	
		TYP				TYP	MAX	TYP	
SINGLE COLOR LED ASSEMBLIES (20mA)									
FV3-X.X-UB-F6PX67PR	BLUE	470	150	25	70	4.0	4.5	400	3UBWC-0.6K-F
FV3-X.X-UG-F6PX67PR	GREEN	570	100	30	150	2.1	2.4	200	3UGC-F
FV3-X.X-UY-F6PX67PR	YELLOW	590	85	30	150	2.0	2.4	300	3UYC-F
FV3-X.X-UR-F6PX67PR	RED	645	60	30	150	1.7	2.4	200	3URC-F
BI-COLOR LED ASSEMBLIES (20mA)									
FV3-X.X-SRG-F6PX67PR	RED	645	70	30	150	1.7	2.4	100	3SBCC-F
	GREEN	568	80	30	150	2.1	2.8	60	

ABSOLUTE MAXIMUM RATINGS (Ta=25°C)

REVERSE VOLTAGE _____ 5V
 REVERSE CURRENT _____ 100µA
 OPERATING TEMPERATURE RANGE _____ -25°C ~ +85°C
 STORAGE TEMPERATURE _____ -30°C ~ +100°C
 LEAD SOLDERING TEMPERATURE(1/16" FROM BODY) _____ 260°C FOR 5 SECONDS

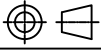
STANDARD TOLERANCE (UNLESS OTHERWISE SPECIFIED)		 4 THOMAS, IRVINE, CA. 92618 TEL: (949) 951-8808 FAX: (949) 951-3974		
DECIMALS	ANGULAR			
		TITLE: IP67 RATED PANEL MOUNT FLP INDICATOR, VERTICAL		
		DESIGNED: TD. Nguyen	DATE: 04/30/17	PART NO: FV3-X.X-XXX-F6PX67PR
CHECKED: K. Baron		DATE: 04/30/17	CAGE CODE : 32559	SHEET # 2 OF 2
CAD GENERATED DOCUMENT. DO NOT MEASURE DRAWING.				