



User Guide

EVB-ATEK750N3-01

Document Code : 023-131101
Revision No : 03
Revision Date : 16/04/2022

Revisions

Revision No	Revision Date	Revision Reason	Section / Page No
1.0	28.07.2021	Initial Version	
1.1	10.01.2022	Format and Content Fixed	
1.2	16.04.2022	Format and Content Fixed	

INDEX

1	GENERAL INFORMATION	3
2	DESIGN INFORMATION.....	4
2.1	SCHEMATIC.....	4
2.2	BOM	4
3	TYPICAL PERFORMANCE PLOTS.....	5
4	TYPICAL PERFORMANCE PLOTS.....	6

1 GENERAL INFORMATION

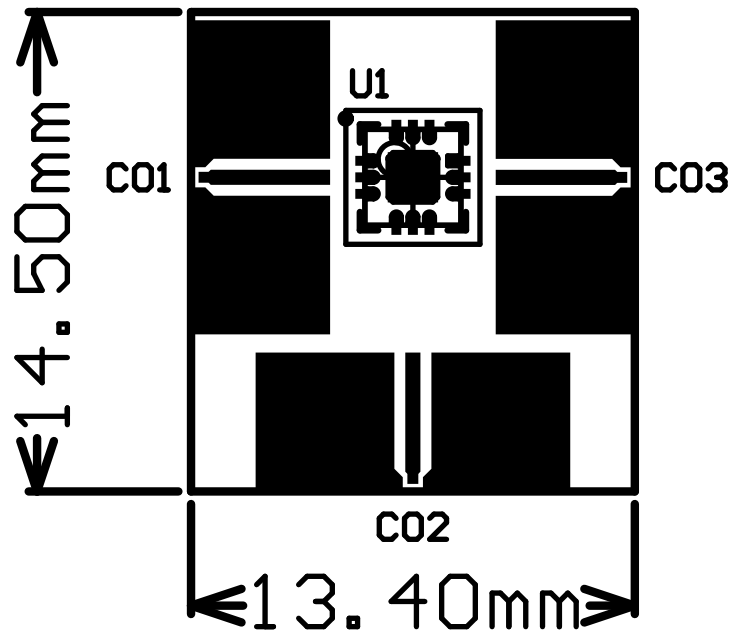

PIN Name	Definition	Comment
C01	LO	K Connector
C02	IF	K Connector
C03	RF	K Connector

Notes:

1. N/A.

2 DESIGN INFORMATION

2.1 SCHEMATIC

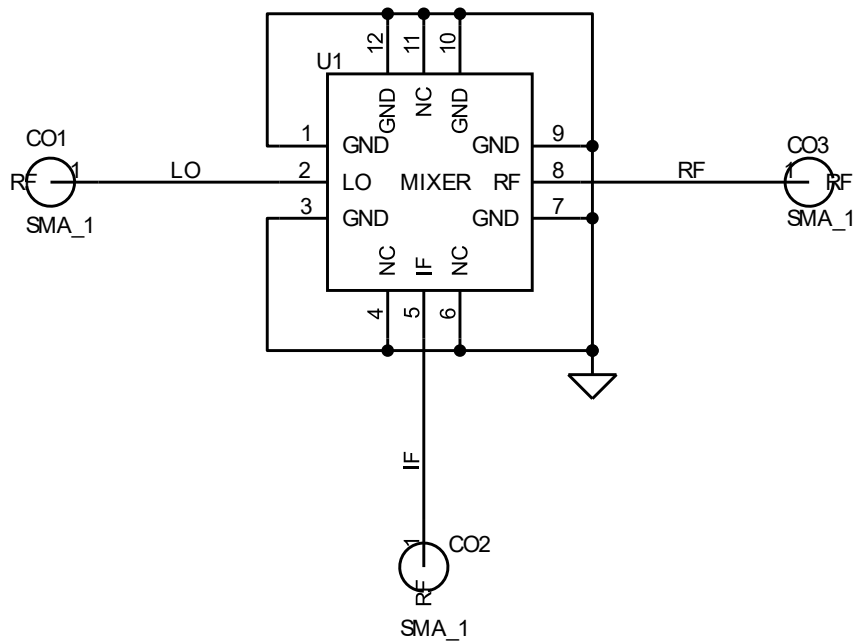

2.2 BOM

Designator	Footprint	Qty	Comment	PN
CO1, CO2, CO3	K Connector	3	K Connector	ATEK9292
U1	ATEKQ3312	1	Mixer	ATEK750N3

3 TYPICAL PERFORMANCE PLOTS

Conditions unless otherwise specified: Typical, T = 25 C, CW. Downconverter. For details, please refer to the datasheet.

Conversion Gain vs. LO Power, IF=1 GHz, Lower Sideband

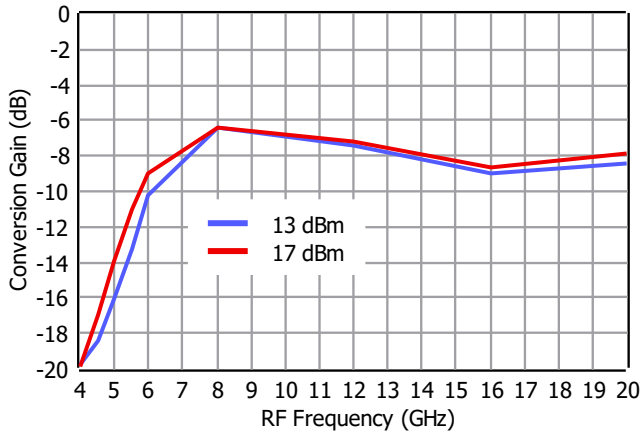

Conversion Gain vs. LO Power, IF=3 GHz, Upper Sideband

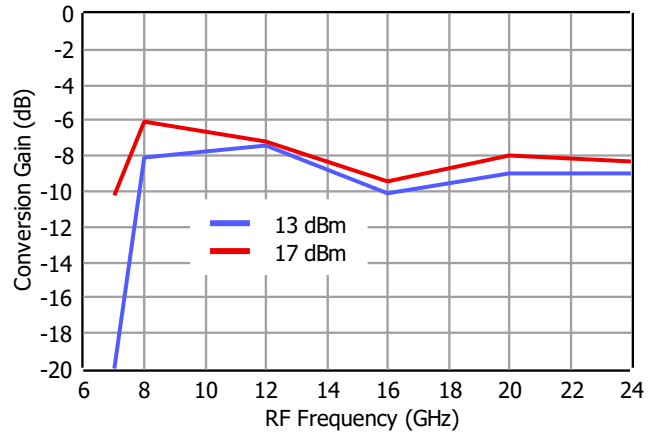

Conversion Gain vs. LO Power, IF=6 GHz, Upper Sideband

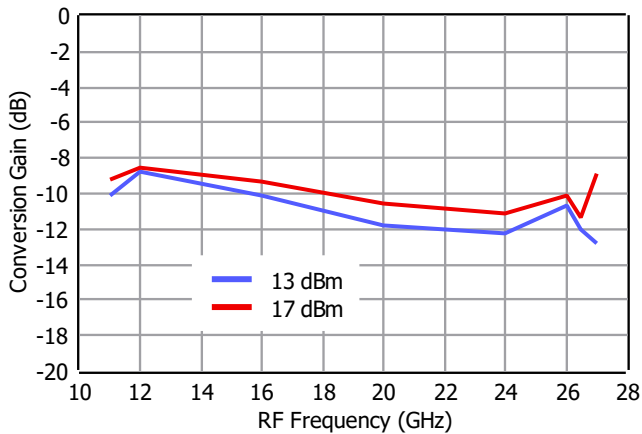

Conversion Gain vs. LO Power, IF=8 GHz, Upper Sideband

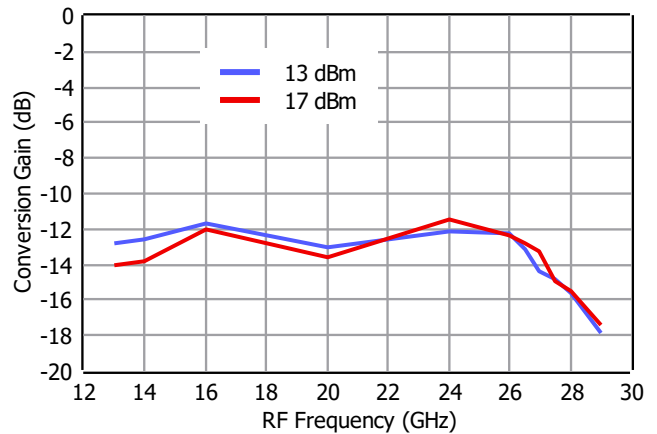

Conversion Gain vs. IF Frequency, LO Power Upper Sideband, RF=16 GHz

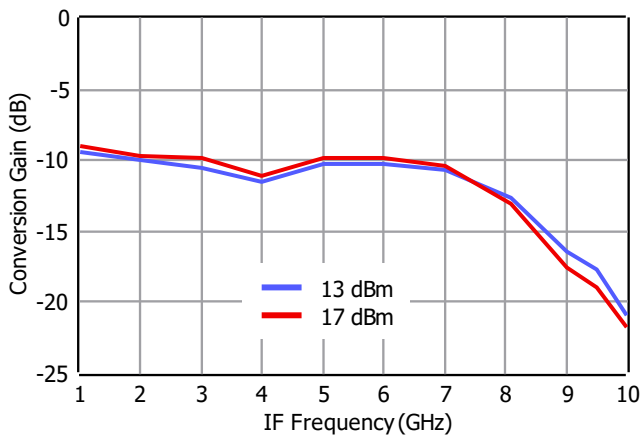

4 TYPICAL PERFORMANCE PLOTS

Conditions unless otherwise specified: Typical, T = 25 C, CW. Downconverter. For details, please refer to the datasheet.

RF Return Loss vs. LO Power, LO=18 GHz,
Upper Sideband

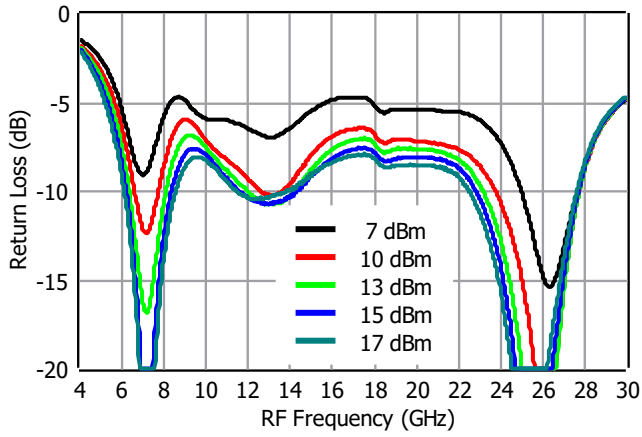

LO Return Loss vs. RF Power, RF=18 GHz,
Upper Sideband

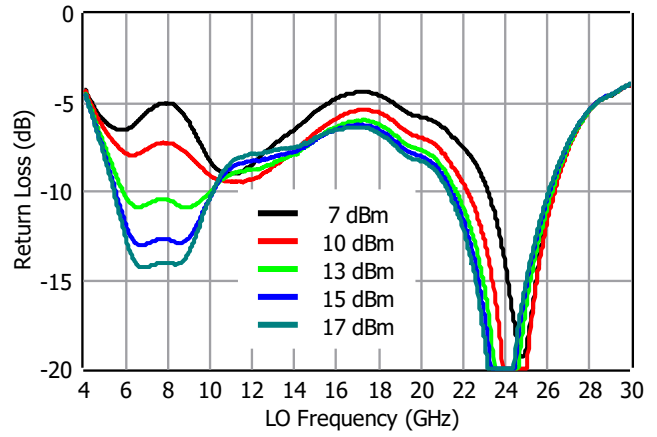

IF Return Loss vs. RF Power, RF=18 GHz,
Upper Sideband

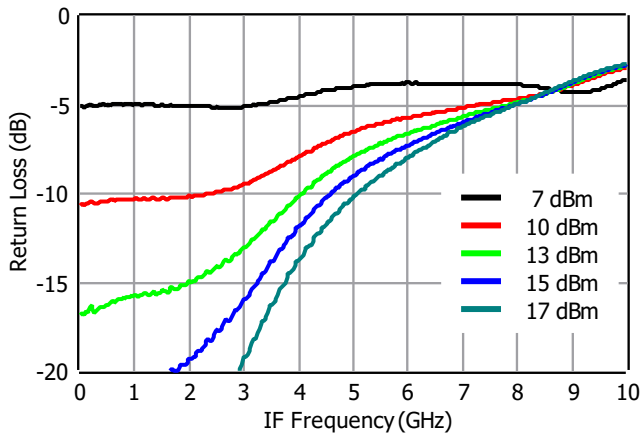

IF Return Loss vs. LO Power, LO=18 GHz,
Upper Sideband

