

Click [here](#) to ask about the production status of specific part numbers.

## MAX17579EVKIT#, MAX17580EVKIT# Evaluation Kits

## Evaluate: MAX17579 and MAX17580 in -15V and -5V Output-Voltage Applications

### General Description

The MAX17579EVKIT# and MAX17580EVKIT# evaluation kits (EV kits) provide a proven design to evaluate the MAX17579 and MAX17580 high-efficiency, high-voltage, inverting, Himalaya synchronous DC-DC converters. The devices generate output voltages ( $V_{OUT}$ ) from -0.9V to -36V and can deliver up to 300mA of load current from a wide 4.5V to 60V- $|V_{OUT}|$  input voltage range.

The MAX17579EVKIT# EV kit generates -15V output ( $V_{OUT1}$ ) at load currents up to 240mA from a 16V to 45V input supply and operates at 600kHz ( $f_{SW1}$ ) switching frequency. This EV kit configuration features MAX17579 that operates in continuous conduction mode (CCM) at all loads, thus, providing a constant frequency operation.

The MAX17580EVKIT# EV kit generates -5V output ( $V_{OUT2}$ ) at load currents up to 300mA from a 16V to 55V input supply and operates at 600kHz ( $f_{SW2}$ ) switching frequency. This EV kit configuration features MAX17580 that operates in discontinuous conduction mode (DCM) for superior efficiency at light loads.

The EV kits are configured for optimum efficiency and component size. The EV kits feature programmable enable and input undervoltage-lockout (UVLO), soft-start, open-drain  $\overline{RESET}$  signal and external clock synchronization. The EV kits also provide a good layout example, which are optimized for conducted, radiated EMI, and thermal performance. For more details about the device *Benefits and Features*, refer to the MAX17579, MAX17580 IC data sheet.

### Features

- Operates Over a Wide Input Range
  - MAX17579EVKIT#:  $V_{OUT1} = -15V$ ,  $I_{OUT1} = 240mA$ ,  $V_{IN1}$  Range = 16V to 45V
  - MAX17580EVKIT#:  $V_{OUT2} = -5V$ ,  $I_{OUT2} = 300mA$ ,  $V_{IN2}$  Range = 16V to 55V
- Enable/UVLO Input, Resistor Programmable UVLO Threshold
- Adjustable Soft-Start Time
- $\overline{RESET}$  Output with a Pullup Resistor to an External Supply
- System Ground Interfaced EN/UVLO and  $\overline{RESET}$  Pins
- Overcurrent and Overtemperature Protection
- Proven PCB Layout
- Fully Assembled and Tested
- Complies with CISPR 32 (EN55032) Class B Conducted and Radiated Emissions

[Ordering Information](#) appears at end of data sheet.

## MAX17579EVKIT#, MAX17580EVKIT# Evaluation Kits

## Evaluate: MAX17579 and MAX17580 in -15V and -5V Output-Voltage Applications

### Quick Start

#### Recommended Equipment

- MAX17579EVKIT#, MAX17580EVKIT#
- 60V, 0.5A DC input power supply
- 5V, 10mA DC input power supply
- Loads capable of sinking 300mA at -5V and 240mA at -15V
- Two digital multimeters (DMM)

#### Equipment Setup and Test Procedure

The EV kits are fully assembled and tested.

Use the following steps to verify and test individual device operation.

**Caution: Do not turn on the power supply until all connections are completed.**

- 1) Set the 60V input power supply at 15V for MAX-17579EVKIT# and MAX17580EVKIT#. Disable the power supply.
- 2) Connect the positive terminal of the 60V power supply to the VIN PCB pad and the negative terminal to the nearest GND PCB pad.
- 3) Connect the positive terminal of the 5V power supply to the respective VEXT PCB pad and the negative terminal to the nearest GND PCB pad. Set the voltage at 5V.
- 4) Connect the positive terminal of the corresponding load to the respective GND PCB pad and the negative terminal to the nearest VOUT PCB pad.
- 5) Connect one DMM across the respective VOUT PCB pad and the nearest GND PCB pad, and the another DMM across the respective RESET pad and GND pad.
- 6) Verify that no shunts are installed on jumpers (J101, J201) See [Table 1](#) for details.
- 7) Turn on the DC power supply.
- 8) Enable the load.
- 9) Observe that both the DMMs display 0V.
- 10) Increase the input voltage to be above 16V or higher, which is above the EN/UVLO rising threshold.
- 11) Verify that the DMM across the output terminal displays -15V for MAX17579EVKIT# or -5V for MAX17580EVKIT#.
- 12) Verify that the DMM across the RESET pad and GND displays 5V.
- 13) Reduce the input voltage to 12V which is below the EN/UVLO falling threshold.
- 14) Verify that both the DMMs displays 0V.
- 15) Disable the input power supply.

### Detailed Description of Hardware

The MAX17579EVKIT# and MAX17580EVKIT# EV kits are designed to demonstrate the salient features of MAX17579 and MAX17580 devices, respectively. These two circuits are electrically isolated from each other and hosted on the same PCB. Each of the devices can be evaluated by powering them from their respective input pins. Individual device settings can be adjusted to evaluate their performance under different operating conditions.

#### Soft-Start Input (SS)

The EV kits offer an adjustable soft-start function to limit inrush current during startup. The soft-start time is adjusted by the value of external soft-start capacitor connected between SS and SOUT pins. The selected output capacitance ( $C_{OUT}$ ) and the output voltage ( $V_{OUT}$ ) determine the minimum required soft-start capacitor  $C_{SS}$  (C112, C212) as follows:

$$C_{SS} \geq 139 \times 10^{-6} \times C_{OUT} \times V_{OUT}$$

The soft-start time ( $t_{SS}$ ) is related to the capacitor connected at SS ( $C_{SS}$ ) by the following equation:

$$t_{SS} = \frac{C_{SS}}{5.55 \times 10^{-6}}$$

For example, to program a 1ms soft-start time, a 5600pF capacitor should be connected from the SS pin to SOUT.

#### Enable/Undervoltage-Lockout (EN/UVLO) Programming

The MAX17579 and MAX17580 offer an enable and adjustable input UVLO feature. In these EV kits, for normal operation, leave the EN/UVLO jumpers (J101, J201) open. When jumpers are left open, the MAX17579 and MAX17580 are enabled when the input voltage rises above 15.7V. To disable the devices, install shunts across pins 2–3 on the jumpers (J101, J201). See [Table 1](#) for jumper (J101, J201) settings. The EN/UVLO PCB pad on the EV kits support external Enable/Disable control of the device. Leave the jumpers open when external Enable/Disable control is desired. A potential divider formed by the resistors  $R_{UVL\_TOP}$  (R101, R201) and  $R_{UVL\_BOT}$  (R102, R202) at the EN/UVLO pin sets the input voltage ( $V_{INU}$ ) above which the converter is enabled when the jumpers are left open.

Choose  $R_{UVL\_TOP}$  to be 3.32M $\Omega$  (max), and then calculate  $R_{UVL\_BOT}$  as follows:

$$R_{UVL\_BOT} = \frac{1.229 \times R_{UVL\_TOP}}{(V_{INU} - 1.229)}$$

where,  $R_{UVL\_BOT}$  is in M $\Omega$ . For more details about *Setting the Input Undervoltage-Lockout Level*, refer to the MAX17579, MAX17580 IC data sheet.

## MAX17579EVKIT#, MAX17580EVKIT# Evaluation Kits

## Evaluate: MAX17579 and MAX17580 in -15V and -5V Output-Voltage Applications

### External Clock Synchronization (RT/SYNC)

The EV kits provide RT/SYNC PCB pads to synchronize the MAX17579 and MAX17580 to an optional external clock. The external synchronization clock frequency must be between  $1.1 \times f_{SW}$  and  $1.4 \times f_{SW}$ , where  $f_{SW}$  is the switching frequency programmed by the resistors (R105 and R205) connected to the RT/SYNC pin. For more details about the *External Clock Synchronization*, refer to the MAX17579, MAX17580 IC data sheet.

### Active-Low, Open-Drain Reset Output (RESET)

The EV kits provide two PCB pads  $\overline{\text{RESET}}_1$  and  $\overline{\text{RESET}}_2$  to monitor the status of the respective converters. The open-drain outputs are connected to 5V external power supply (VEXT1, VEXT2) via pullup resistors (R106, R206).  $\overline{\text{RESET}}$  goes high 1024 switching cycles after the output voltage rises above 95% (typ) of its set value and it is driven low to respective GND when the output voltage drops below 92% (typ) of its set value.

### Input Voltage Range

The MAX17579EVKIT# and MAX17580EVKIT# has a default input voltage range starting from 16V. The operating input voltage range can be modified by changing the values of the components connected at the FB, EN/UVLO, and SS pins for the same inductor and output capacitor. The deliverable output current also changes with input voltage range. For more details about the *Load Current Capability*, refer to the MAX17579, MAX17580 IC data sheet. [Table 2](#) and [Table 3](#) show the settings for different input voltage ranges for MAX17579EVKIT# and MAX17580EVKIT#, respectively.

### Hot Plug-In and Long Input Cables

The MAX17579EVKIT# and MAX17580EVKIT# PCB layouts provide optional electrolytic capacitors (C108 = C208 = 22 $\mu$ F/80V). These capacitors limit the peak voltage at the input of the corresponding device when the DC input source is Hot-Plugged to the EV kit input terminals with input cables. The equivalent series resistance (ESR) of the electrolytic capacitors dampen the oscillations caused by interaction of the inductance of the input cables, and the ceramic capacitors at the converters input.

### Inductive Output Short-Circuit Protection

The MAX17579EVKIT# and MAX17580EVKIT# PCB layouts provide footprints for optional R-D circuits (R107 and D101, R207 and D201) that are used for *Inductive Output Short-Circuit Protection*. For more details, refer to the MAX17579, MAX17580 IC data sheet.

### Electromagnetic Interference (EMI)

Compliance to conducted emissions (CE) standards requires an EMI filter at the input of a switching power converter. The EMI filter attenuates high-frequency currents drawn by the switching power converter and limits the noise injected back into the input power source.

The MAX17579EVKIT# and MAX17580EVKIT# PCBs have designated footprints for placement of conducted EMI filter components per the optional Bill of Materials (BoM). Use of these filter components results in lower conducted EMI, below CISPR 32 Class B limits. Cut open the trace at L102 and L202 before installing EMI filter components. The PCB layouts are also designed to limit radiated emissions from switching nodes of the power converter, resulting in radiated emissions below CISPR 32 Class B limits.

**Table 1. Converter EN/UVLO Jumper (J101, J201) Settings**

SHUNT POSITION	EN/UVLO PIN	OUTPUT
1-2	Connected to IN	Enabled
Not installed*	Connected to the center node of respective resistor-dividers (R101 and R102; R201 and R202)	Enabled, UVLO level is set by the resistor-divider between IN and GND
2-3	Connected to GND	Disabled

\*Default position

**Table 2. MAX17579EVKIT# EN/UVLO and FB Resistor Divider Settings**

INPUT VOLTAGE RANGE	R101	R102	R103	R104	LOAD CURRENT	C112
16V to 45V*	3.32M $\Omega$	294k $\Omega$	412k $\Omega$	26.1k $\Omega$	240mA	5.6nF
8V to 45V	3.32M $\Omega$	665k $\Omega$	536k $\Omega$	34k $\Omega$	150mA	5.6nF
4.5V to 45V	3.32M $\Omega$	1.37M $\Omega$	523k $\Omega$	33.2k $\Omega$	80mA	10nF

\*Default setting

MAX17579EVKIT#, MAX17580EVKIT#  
Evaluation Kits

Evaluate: MAX17579 and MAX17580  
in -15V and -5V Output-Voltage  
Applications

**Table 3. MAX17580EVKIT# EN/UVLO and FB Resistor Divider Settings**

INPUT VOLTAGE RANGE	R201	R202	R203	R204	LOAD CURRENT	C212
16V to 55V*	3.32MΩ	294kΩ	154kΩ	34kΩ	300mA	5.6nF
8V to 55V	3.32MΩ	665kΩ	165kΩ	36.5kΩ	240mA	5.6nF
4.5V to 55V	3.32MΩ	1.37MΩ	187kΩ	41.2kΩ	150mA	5.6nF

\*Default setting

**MAX17579EVKIT# and MAX17580EVKIT# EV Kit Performance Reports**

(VIN1 = VIN2 = 24V, fSW1 = fSW2 = 600kHz, unless otherwise noted.)

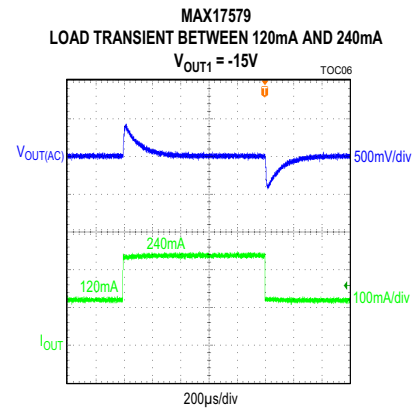
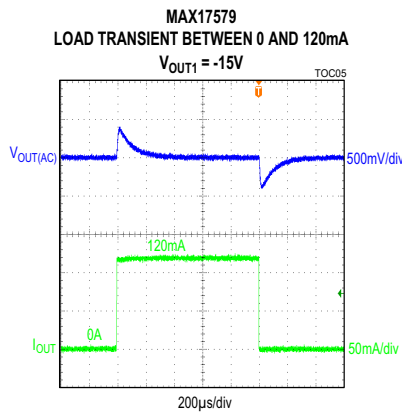
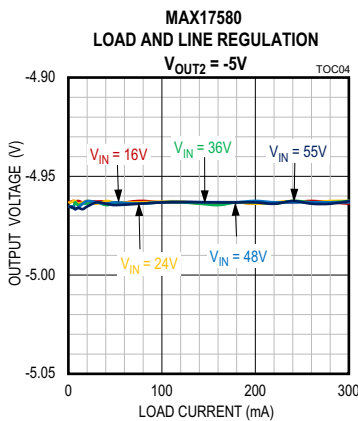
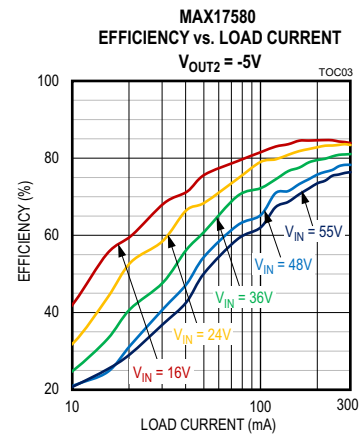
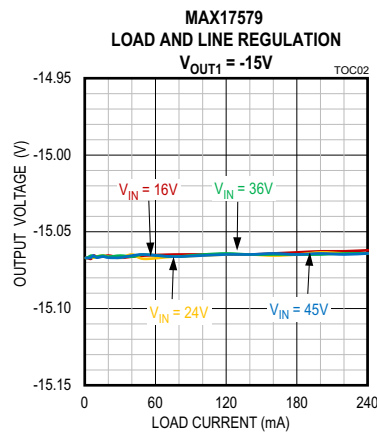
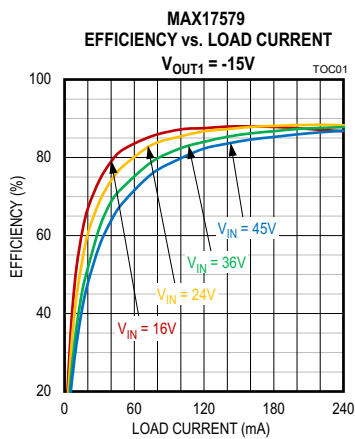

MAX17579EVKIT#, MAX17580EVKIT#  
Evaluation Kits

Evaluate: MAX17579 and MAX17580  
in -15V and -5V Output-Voltage  
Applications

MAX17579EVKIT# and MAX17580EVKIT# EV Kit Performance Reports (continued)

(VIN1 = VIN2 = 24V, fSW1 = fSW2 = 600kHz, unless otherwise noted.)

MAX17580  
LOAD TRANSIENT BETWEEN 15mA AND 150mA  
VOUT2 = -5V

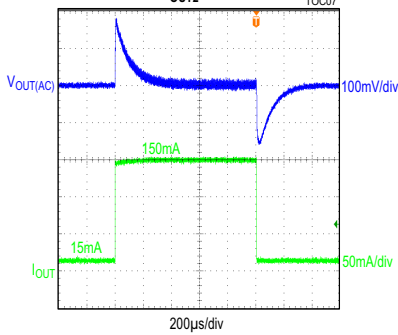

MAX17580  
LOAD TRANSIENT BETWEEN 150mA AND 300mA  
VOUT2 = -5V

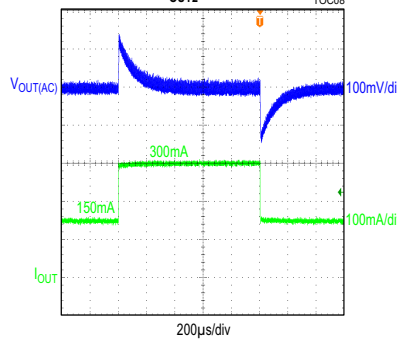

MAX17579  
STEADY STATE AT 240mA LOAD  
VOUT1 = -15V

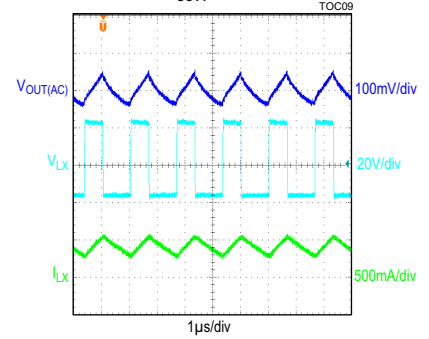

MAX17579  
STEADY STATE AT NO LOAD  
VOUT1 = -15V

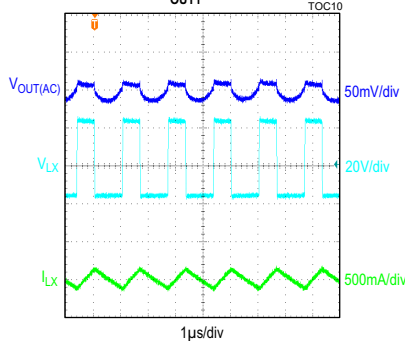

MAX17580  
STEADY STATE AT 300mA LOAD  
VOUT2 = -5V

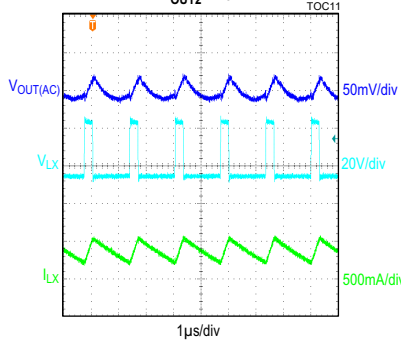

MAX17580  
STEADY STATE AT 15mA LOAD  
VOUT2 = -5V

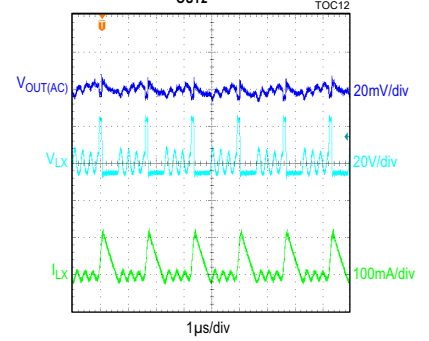

MAX17579  
START UP & SHUT DOWN THROUGH EN/UVLO  
VOUT1 = -15V

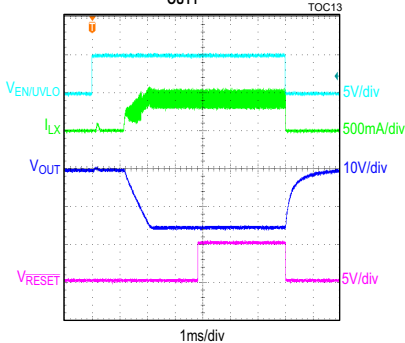

CONDITIONS: 62.5Ω RESISTIVE LOAD,  
RESET IS PULLED UP TO 5V CONNECTED AT VEXT1

MAX17579  
START UP & SHUT DOWN THROUGH EN/UVLO  
VOUT1 = -15V

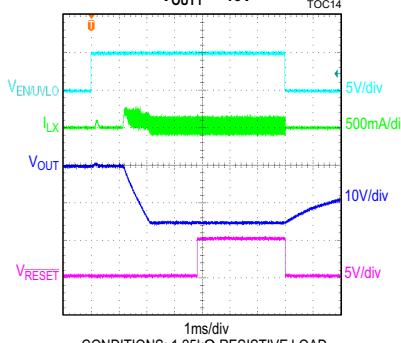

CONDITIONS: 1.25kΩ RESISTIVE LOAD,  
RESET IS PULLED UP TO 5V CONNECTED AT VEXT1

MAX17579  
START UP WITH PREBIAS VOLTAGE OF -7.5V  
VOUT1 = -15V

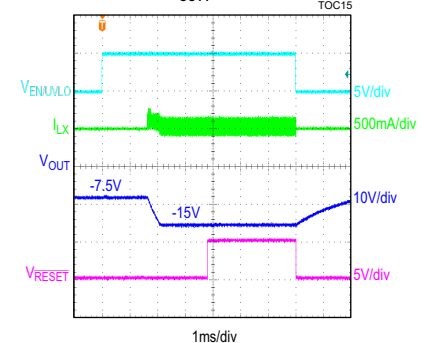

CONDITIONS: 1.25kΩ RESISTIVE LOAD,  
RESET IS PULLED UP TO 5V CONNECTED AT VEXT1

MAX17579EVKIT#, MAX17580EVKIT#  
Evaluation Kits

Evaluate: MAX17579 and MAX17580  
in -15V and -5V Output-Voltage  
Applications

MAX17579EVKIT# and MAX17580EVKIT# EV Kit Performance Reports (continued)

(VIN1 = VIN2 = 24V, fSW1 = fSW2 = 600kHz, unless otherwise noted.)

MAX17580  
START UP & SHUT DOWN THROUGH EN/UVLO  
VOUT2 = -5V

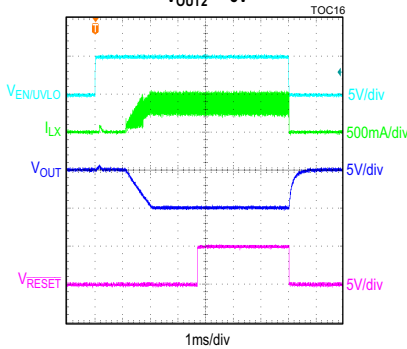

1ms/div  
CONDITIONS: 16.67Ω RESISTIVE LOAD,  
RESET IS PULLED UP TO 5V CONNECTED AT VEXT2

MAX17580  
START UP & SHUT DOWN THROUGH EN/UVLO  
VOUT2 = -5V

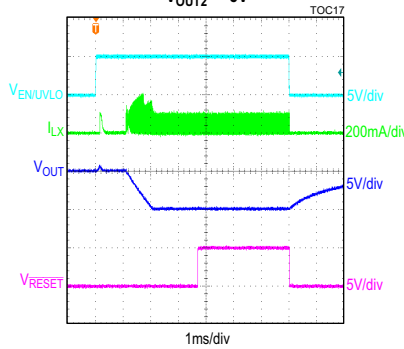

1ms/div  
CONDITIONS: 333.3Ω RESISTIVE LOAD,  
RESET IS PULLED UP TO 5V CONNECTED AT VEXT2

MAX17580  
START UP WITH PREBIAS VOLTAGE OF -2.5V  
VOUT2 = -5V

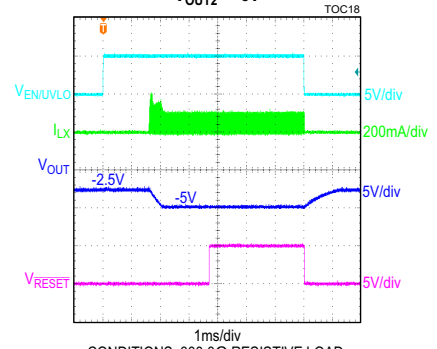

1ms/div  
CONDITIONS: 333.3Ω RESISTIVE LOAD,  
RESET IS PULLED UP TO 5V CONNECTED AT VEXT2

MAX17579  
EXTERNAL CLOCK SYNCHRONIZATION WITH 840kHz  
VOUT1 = -15V

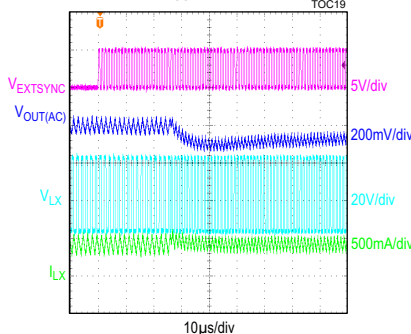

10μs/div  
CONDITIONS: 62.5Ω LOAD

MAX17580  
EXTERNAL CLOCK SYNCHRONIZATION WITH 840kHz  
VOUT2 = -5V

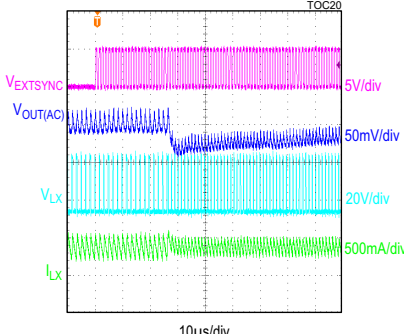

10μs/div  
CONDITIONS: 16.66Ω LOAD

MAX17579  
OVERLOAD PROTECTION  
VOUT1 = -15V

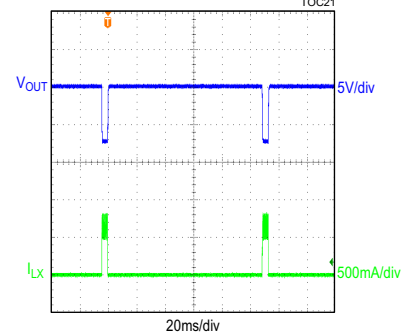

20ms/div  
CONDITIONS: 20Ω LOAD

MAX17580  
OVERLOAD PROTECTION  
VOUT2 = -5V

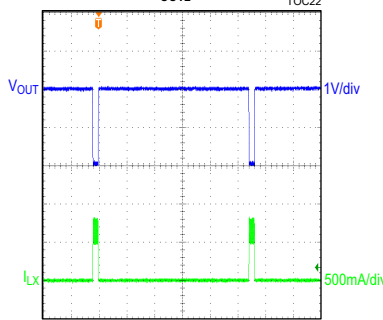

20ms/div  
CONDITIONS: 5Ω RESISTIVE LOAD

MAX17579  
BODE PLOT, VOUT1 = -15V

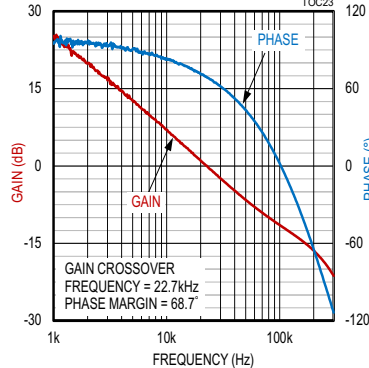

CONDITIONS: 62.5Ω LOAD

MAX17580  
BODE PLOT, VOUT2 = -5V

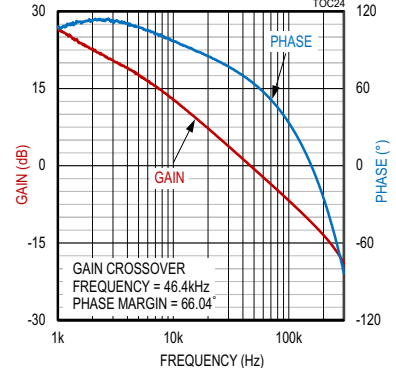

CONDITIONS: 16.67Ω LOAD



MAX17579EVKIT#, MAX17580EVKIT#  
Evaluation Kits

Evaluate: MAX17579 and MAX17580  
in -15V and -5V Output-Voltage  
Applications

**MAX17579EVKIT# and MAX17580EVKIT# EV Kit Performance Reports (continued)**

(VIN1 = VIN2 = 24V, fSW1 = fSW2 = 600kHz, unless otherwise noted.)

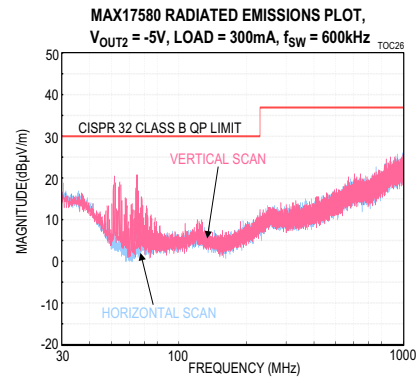
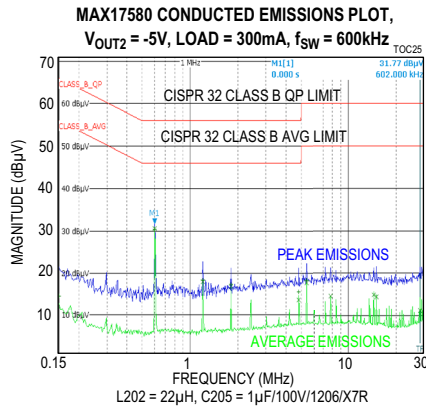

**Component Suppliers**

SUPPLIER	WEBSITE
Würth Electronics	www.we-online.com
Murata Americas	www.murataamericas.com
Panasonic Corp.	www.panasonic.com
SullinsCorp	www.sullinscorp.com
TDK	www.tdk.com

**Note:** Indicate that you are using the MAX17579/MAX17580 when contacting these component suppliers.

**Ordering Information**

PART	TYPE
MAX17579EVKIT#	EV Kit
MAX17580EVKIT#	EV Kit

#Denotes RoHs compliance.

MAX17579EVKIT#, MAX17580EVKIT#  
Evaluation Kits

Evaluate: MAX17579 and MAX17580  
in -15V and -5V Output-Voltage  
Applications

MAX17579EVKIT# and MAX17580EVKIT# EV Kit Bill of Materials

S.No	DESIGNATOR	DESCRIPTION	QUANTITY	MANUFACTURER PART NUMBER
1	C101, C201	150pF±5%; 100V; C0G; Ceramic Capacitor (0402)	2	TDK C1005C0G2A151J050BA
2	C102, C111, C202, C211	0.1µF±10%; 100V; X7R; Ceramic Capacitor (0603)	4	MURATA GRM188R72A104KA35
3	C108, C208	22µF±20%, 80V, Electrolytic capacitor	2	PANASONIC EEE-FK1K220P
4	C110, C210	1µF±10%; 100V; X7R; Ceramic Capacitor (1206)	2	TDK C3216X7R2A105K160AA
5	C112, C212	5600pF±10%; 25V; X7R; Ceramic Capacitor (0402)	2	MURATA GRM155R71E562KA01
6	C113, C213	2.2µF±10%; 10V; X7R; Ceramic Capacitor (0603)	2	MURATA GRM188R71A225KE15
7	C114, C214	4700pF±10%; 100V; X7R; Ceramic Capacitor (0402)	2	MURATA GRM155R72A472KA01
8	C115, C116, C119, C215, C216, C219	0.1µF±10%; 25V; X7R; Ceramic Capacitor (0402)	6	MURATA GRM155R71E104KE14
9	C117	10µF±10%; 25V; X7R; Ceramic Capacitor (0805)	1	MURATA GRM21BZ71E106KE15
10	C118	0.22µF±10%; 25V; X7R; Ceramic Capacitor (0402)	1	TDK C1005X7R1E224K050BB
11	C120, C220	33pF±5%; 50V; C0G; Ceramic Capacitor (0402)	2	MURATA GRM1555C1H330JA01
12	C121, C218, C221	0.47µF±10%; 10V; X7R; Ceramic Capacitor (0402)	3	MURATA GRM155R71A474KE01
13	C217	10µF±10%; 10V; X7R; Ceramic Capacitor (0603)	1	MURATA GRM188Z71A106KA73
14	J101, J201	3-pin Header (2.54mm)	2	SULLINS PEC03SAAN
15	L101	68µH±10%; IRMS=0.8A; Inductor (5mm x 5mm)	1	WURTH 74404054680
16	L201	22µH±10%; IRMS=1.7A; Inductor (4.1mm x 4.1mm)	1	WURTH 74438356220
17	R101, R201	3.32MΩ, ±1%, 1/10W, Resistor (0603)	2	
18	R102, R202	294kΩ, ±1%, 1/10W, Resistor (0603)	2	
19	R103	412kΩ, ±1%, 1/16W, Resistor (0402)	1	
20	R104	26.1kΩ, ±1%, 1/16W, Resistor (0402)	1	
21	R105, R205	10.5kΩ, ±1%, 1/16W, Resistor (0402)	2	
22	R106, R206	10kΩ, ±1%, 1/16W, Resistor (0402)	2	
23	R107, R207	0Ω, ±1%, 1/2W, Resistor (0805)	2	
24	R203	154kΩ, ±1%, 1/16W, Resistor (0402)	1	
25	R204	34kΩ, ±1%, 1/16W, Resistor (0402)	1	
26	U101	High-Efficiency, Synchronous, Inverting Output DC-DC Converter (12 TDFN 3mm x 3mm)	1	MAXIM INTEGRATED MAX17579ATC+
27	U201	High-Efficiency, Synchronous, Inverting Output DC-DC Converter (12 TDFN 3mm x 3mm)	1	MAXIM INTEGRATED MAX17580ATC+
28	SU101, SU201	Jumper Socket (2.54mm)	2	SULLINS STC02SYAN
29	C205	Optional: 1µF±10%; 100V; X7R; Ceramic Capacitor (1206)	1	TDK C3216X7R2A105K160AA
30	L202	Optional: 22µH±10%; IRMS=390mA; Inductor (2mm x 1.9mm)	1	COILCRAFT XPL2010-223ML
31	C103, C109, C203, C209	Open: Capacitor (0402)	0	
32	C104, C122, C204, C222	Open: Capacitor (0603)	0	
33	C105	Open: Capacitor (1206)	0	
34	C106, C107, C206, C207	Open: Capacitor (1210)	0	
35	D101, D201	Open: Diode (POWERDI-323)	0	
36	L102	Open: Inductor (3.2mm x 3.5mm)	0	
37	R108, R208	Open: Resistor (0603)	0	

DEFAULT JUMPER TABLE	
JUMPER	SHUNT POSITION
J101	Open
J201	Open





MAX17579EVKIT#, MAX17580EVKIT#  
Evaluation Kits

Evaluate: MAX17579 and MAX17580  
in -15V and -5V Output-Voltage  
Applications

MAX17579EVKIT# and MAX17580EVKIT# EV Kit Schematics (continued)

MAX17580EVKIT# Schematic Diagram

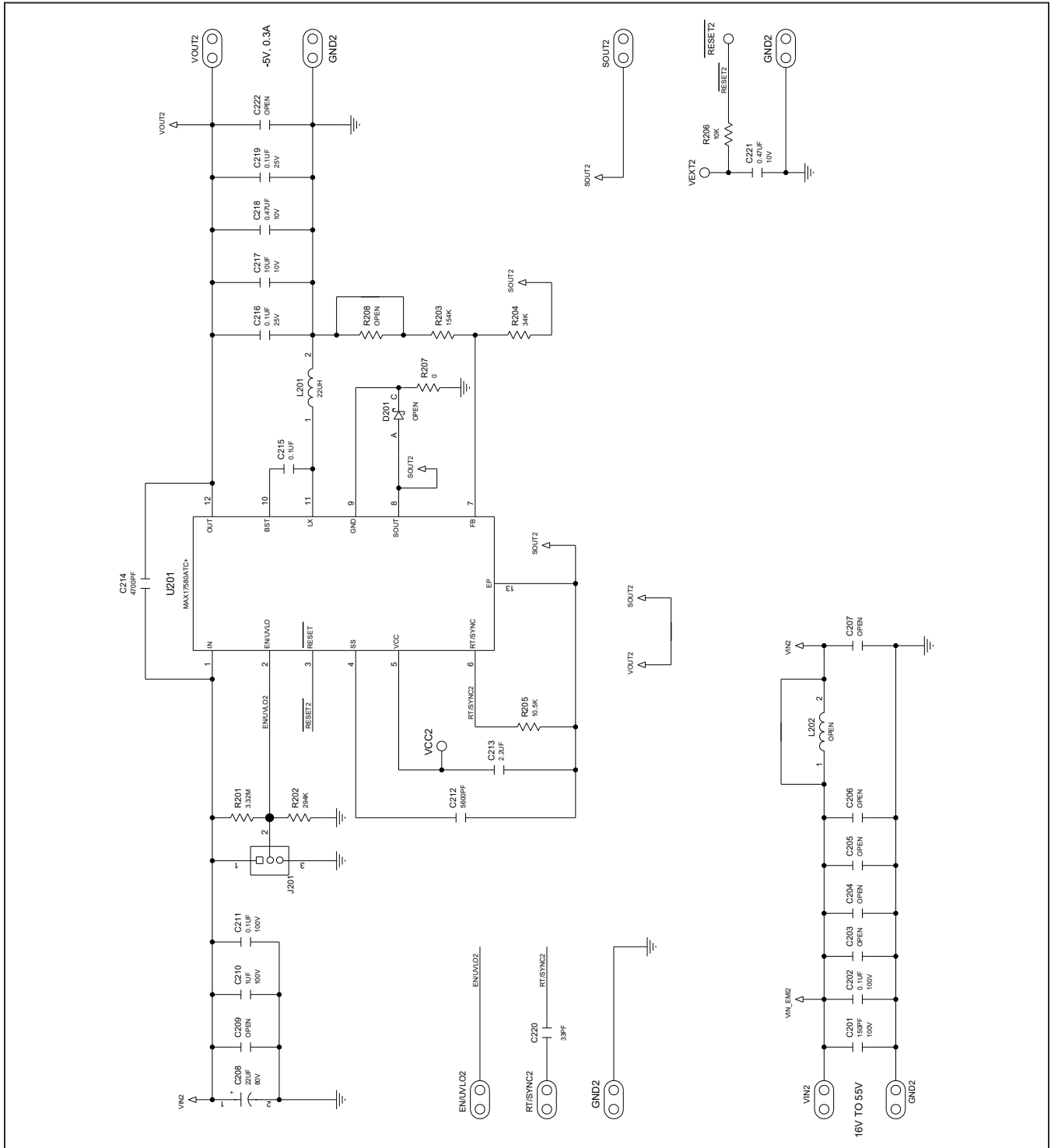

MAX17579EVKIT#, MAX17580EVKIT#  
Evaluation Kits

Evaluate: MAX17579 and MAX17580  
in -15V and -5V Output-Voltage  
Applications

MAX17579EVKIT# and MAX17580EVKIT# EV Kits PCB Layouts

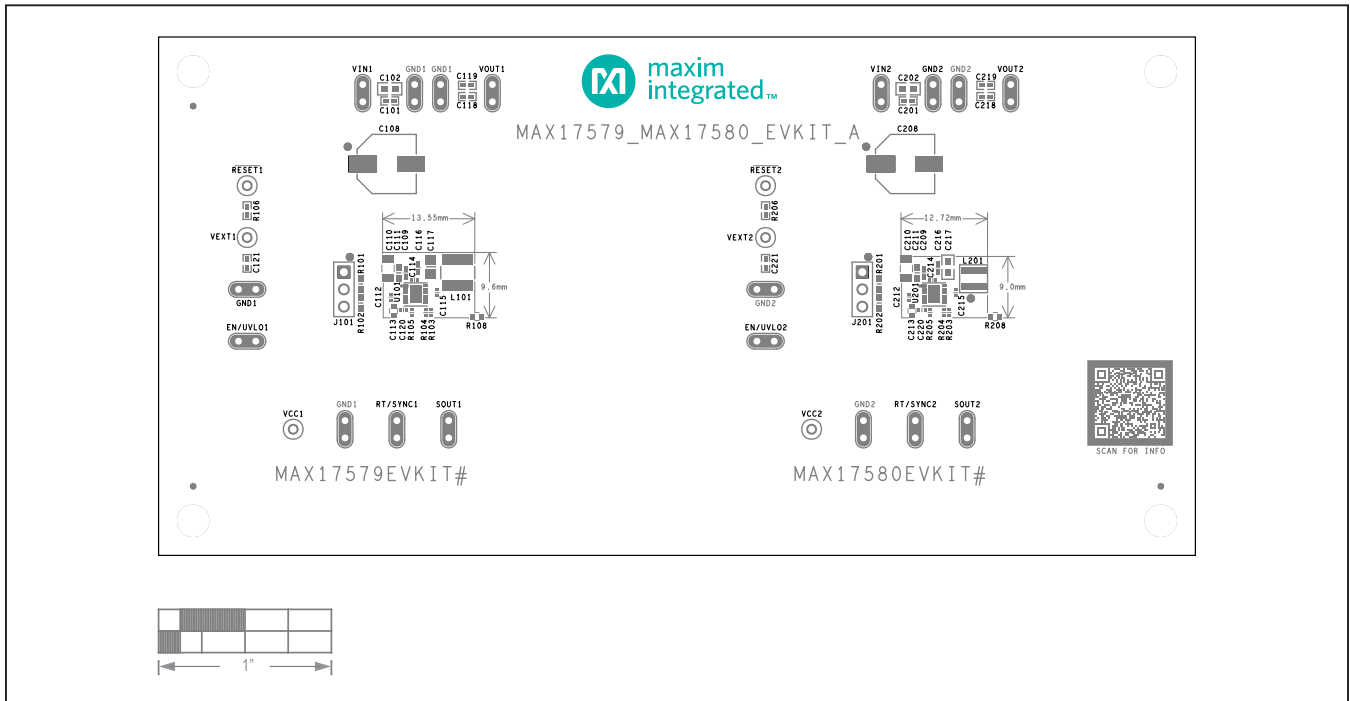

MAX17579EVKIT# and MAX17580EVKIT# EV Kits Component Placement Guide—Top Silkscreen

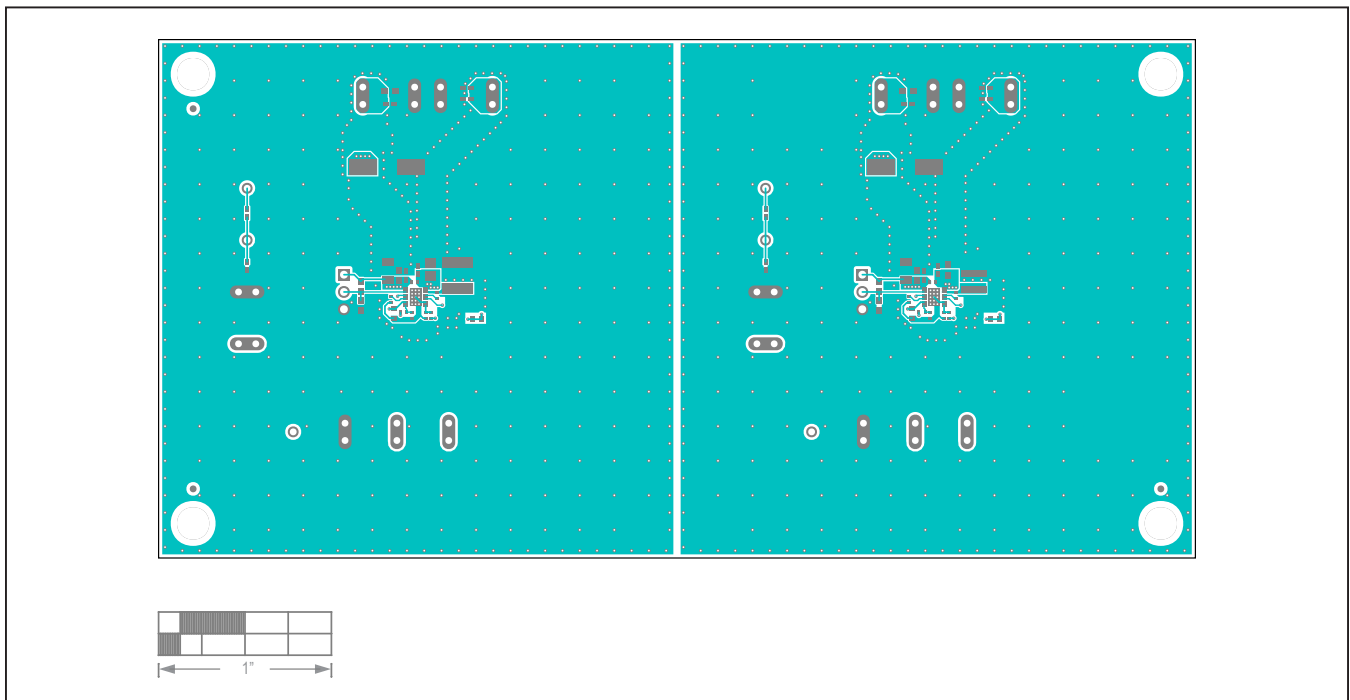

MAX17579EVKIT# and MAX17580EVKIT# EV Kits PCB Layout—Top Layer

MAX17579EVKIT#, MAX17580EVKIT#  
Evaluation Kits

Evaluate: MAX17579 and MAX17580  
in -15V and -5V Output-Voltage  
Applications

**MAX17579EVKIT# and MAX17580EVKIT# EV Kits PCB Layouts (continued)**

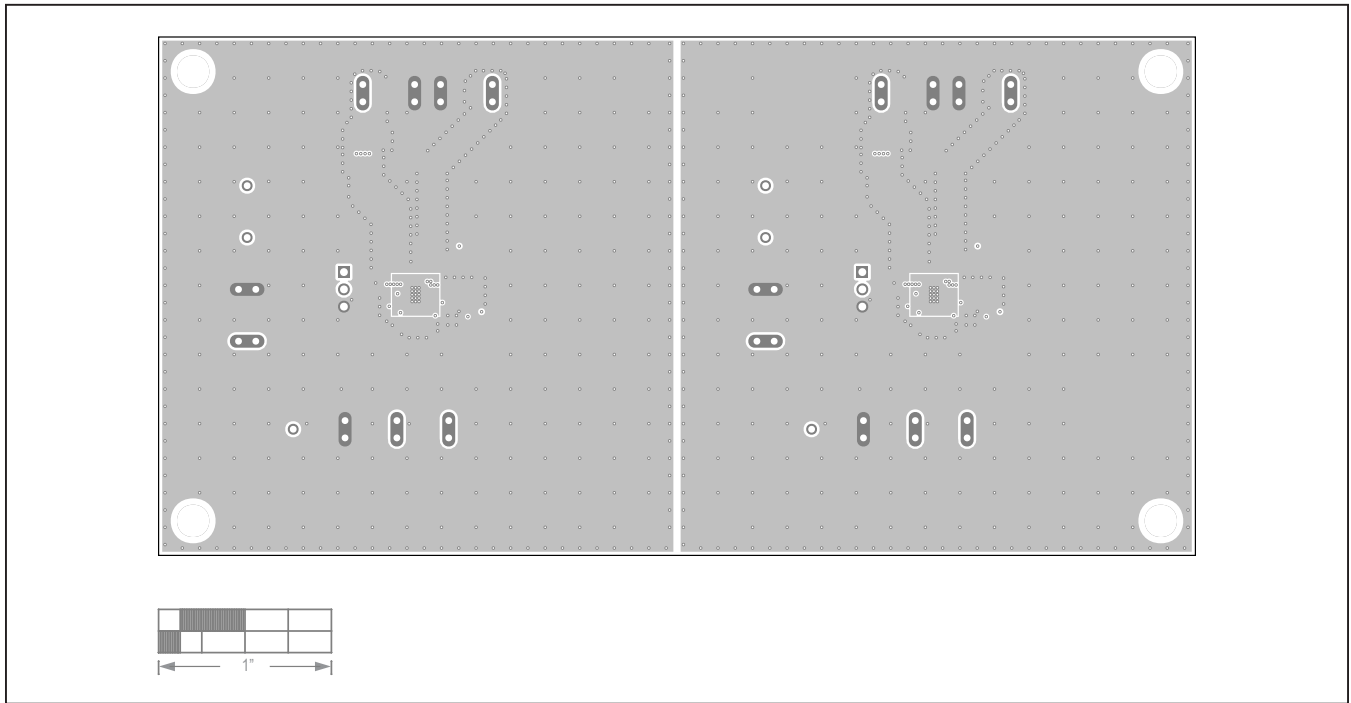

MAX17579EVKIT# and MAX17580EVKIT# EV Kits PCB Layout—Layer 2

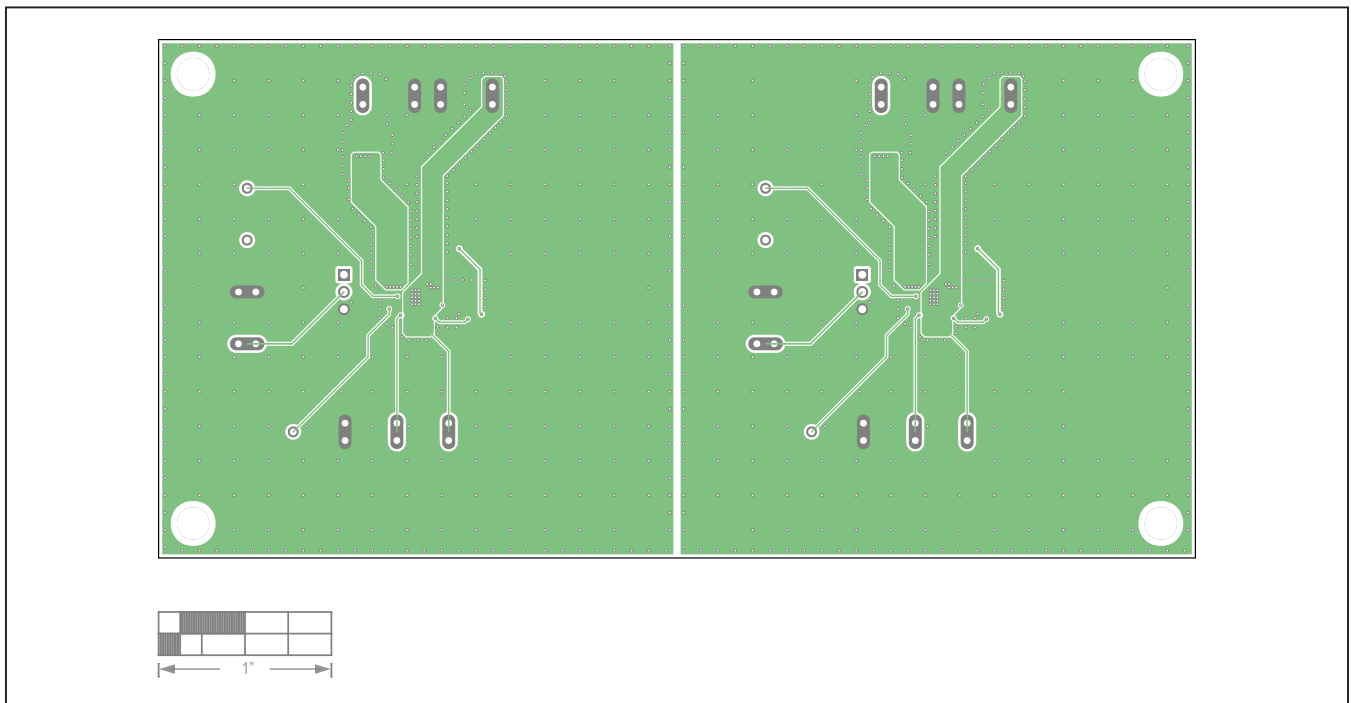

MAX17579EVKIT# and MAX17580EVKIT# EV Kits PCB Layout—Layer 3

MAX17579EVKIT#, MAX17580EVKIT#  
Evaluation Kits

Evaluate: MAX17579 and MAX17580  
in -15V and -5V Output-Voltage  
Applications

### MAX17579EVKIT# and MAX17580EVKIT# EV Kits PCB Layouts (continued)

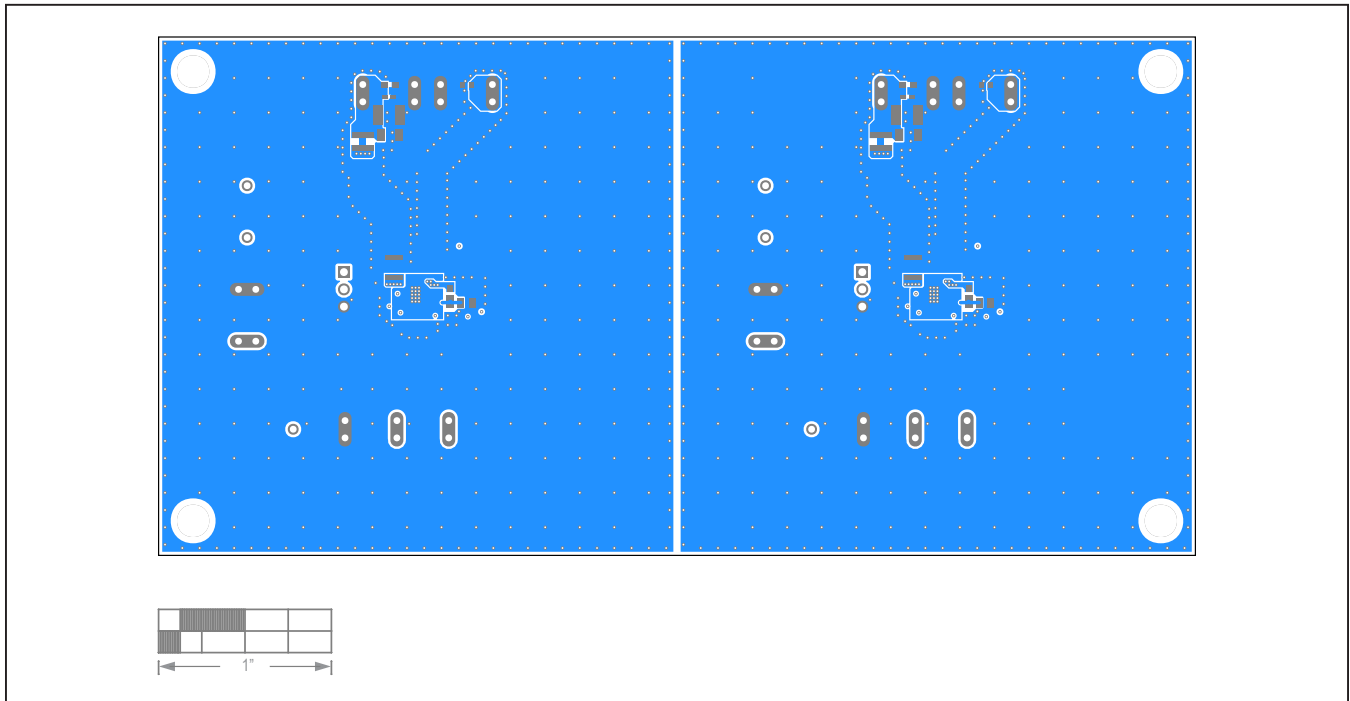

MAX17579EVKIT# and MAX17580EVKIT# EV Kits PCB Layout—Bottom Layer

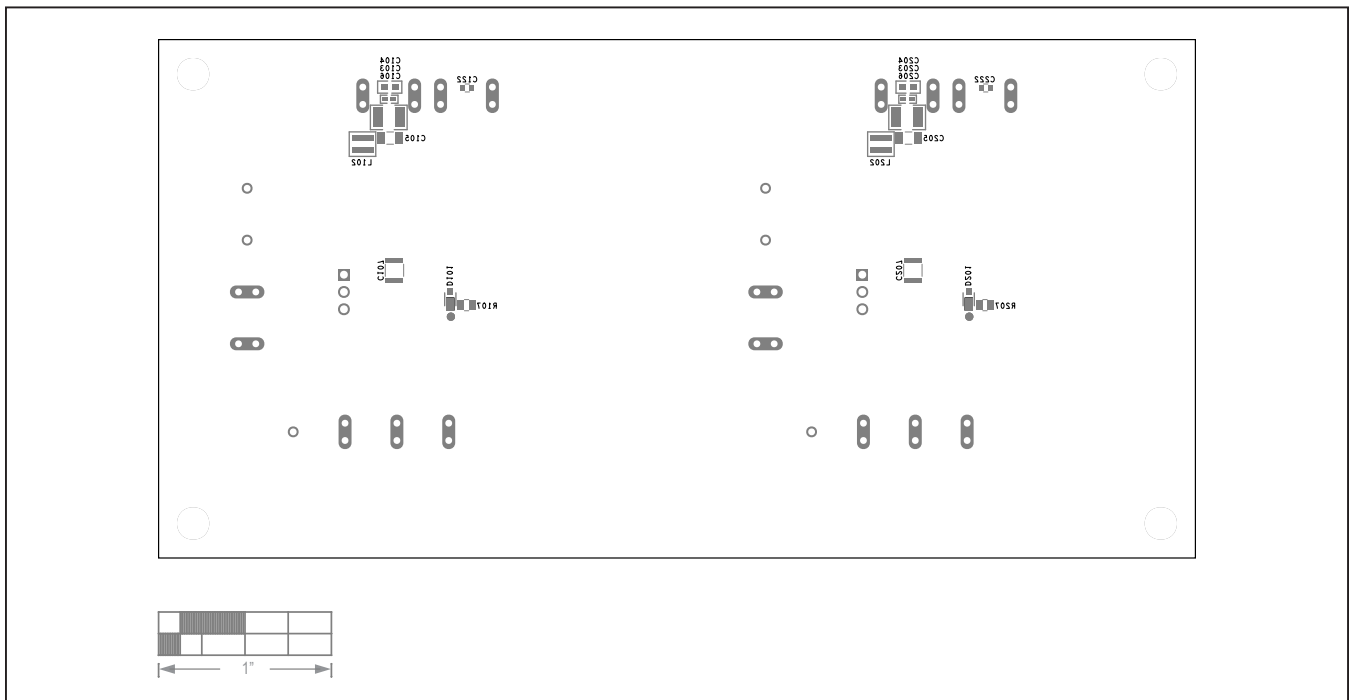

MAX17579EVKIT# and MAX17580EVKIT# EV Kits Component Placement Guide—Bottom Silkscreen

MAX17579EVKIT#, MAX17580EVKIT#  
Evaluation Kits

Evaluate: MAX17579 and MAX17580  
in -15V and -5V Output-Voltage  
Applications

## Revision History

REVISION NUMBER	REVISION DATE	DESCRIPTION	PAGES CHANGED
0	4/21	Initial release	—

For pricing, delivery, and ordering information, please visit Maxim Integrated's online storefront at <https://www.maximintegrated.com/en/storefront/storefront.html>.

*Maxim Integrated cannot assume responsibility for use of any circuitry other than circuitry entirely embodied in a Maxim Integrated product. No circuit patent licenses are implied. Maxim Integrated reserves the right to change the circuitry and specifications without notice at any time.*