



**SURFACE MOUNT**

# Monolithic Amplifier

**LEE2-6+**

50Ω DC to 7 GHz

## THE BIG DEAL

- Wideband, DC to 7 GHz
- Internally Matched to 50 Ohms
- Noise figure, 2.3 dB at 2 GHz
- Low current, 16 mA

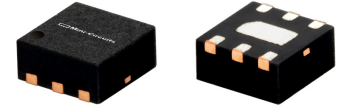

*Generic photo used for illustration purposes only*

CASE STYLE: MC1630-1

### +RoHS Compliant

The +Suffix identifies RoHS Compliance. See our website for methodologies and qualifications

## APPLICATIONS

- Cellular
- PCN instrumentation
- VHF/UHF receivers/transmitters

## PRODUCT OVERVIEW

LEE2-6+ (RoHS compliant) is wideband current driven amplifier fabricated using HBT technology. In addition, the LEE2-6+, has good input and output return loss over a broad frequency range without the need for external matching components. Lead finish is Tin Silver over Nickel. It has repeatable performance from lot to lot and is enclosed in a 2mm x 2mm x 0.89mm 6-lead MCLP package for very good electrical performance.

## KEY FEATURES

Features	Advantages
Broadband, DC* to 7 GHz (* Low frequency cut off determined by external coupling capacitors)	A single amplifier covering DC* to C band. <ul style="list-style-type: none"> <li>• Reduced component inventory</li> <li>• Ideal for wideband applications such as instrumentation and military</li> </ul>
Low Noise Figure: 2.3 dB at 2 GHz	Low noise figure and low current (16mA) is ideal for use as an LNA in receivers
High Gain, 18.9 dB at 2 GHz	Minimizes the effect of NF of succeeding stages.
MCLP Package	Low inductance, repeatable transitions, excellent thermal pad.

REV. B  
ECO-014399  
LEE2-6+  
MCL NY  
220809





SURFACE MOUNT

# Monolithic Amplifier

LEE2-6+

Mini-Circuits

50Ω DC to 7 GHz

### ELECTRICAL SPECIFICATIONS<sup>1</sup> AT 25°C AND 16 mA, UNLESS NOTED OTHERWISE

Parameter	Condition (GHz)	Min.	Typ.	Max.	Units
Frequency Range		DC <sup>2</sup>		7.0	GHz
Gain	0.01	—	21.5	—	dB
	1.0	—	20.6	—	
	2.0	17.1	18.9	21.1	
	4.0	—	15.3	—	
	6.0	—	12.2	—	
	7.0	—	10.8	—	
Isolation	2.0		22.5		dB
Input Return Loss	0.01		29.9		dB
	1.0		21.3		
	2.0		16.0		
	4.0		11.7		
	6.0		9.3		
	7.0		8.4		
Output Return Loss	0.01		36.6		dB
	1.0		17.0		
	2.0		13.4		
	4.0		11.6		
	6.0		11.0		
	7.0		10.4		
Output IP3	0.01		18.9		dBm
	1.0		16.5		
	2.0		17.6		
	4.0		17.8		
	6.0		15.3		
	7.0		14.5		
Output Power @ 1dB Compression	0.01		4.3		dBm
	1.0		2.9		
	2.0		2.8		
	4.0		3.1		
	6.0		2.2		
	7.0		1.2		
Noise Figure	0.01		2.4		dB
	1.0		2.2		
	2.0		2.3		
	4.0		2.5		
	6.0		2.9		
	7.0		3.1		
Device Operating Current (I <sub>bias</sub> )			16		mA
Device Voltage (V <sub>D</sub> )			+3.6		V
Device Voltage Variation vs Temperature at 16mA			-3		mV/°C
Device Voltage Variation vs Current at 25°C			10.6		mV/mA
Thermal Resistance, Junction-to-case <sup>3</sup>			95		°C/W

1. Measured on Mini-Circuits Characterization test board TB-621+. See characterization test circuit. (Fig. 1)

2. Low frequency cut-off determined by external coupling capacitor.





SURFACE MOUNT

# Monolithic Amplifier

## LEE2-6+

Mini-Circuits

50Ω DC to 7 GHz

### MAXIMUM RATINGS<sup>4</sup>

Parameter	Ratings
Operating Temperature	-40°C to 85°C
Storage Temperature	-65°C to 150°C
Operating Current	50 mA
Power Dissipation	200 mW
Input Power (5 minutes max.)	+29 dBm
Input Power (continuous operation)	See Fig. 3

3. Case is defined as ground lead.

4. Permanent damage may occur if any of these limits are exceeded. These ratings are not intended for continuous normal operation.

### PIN (CONTINUOUS OPERATION) VS. FREQUENCY (SAME AS P10dB)

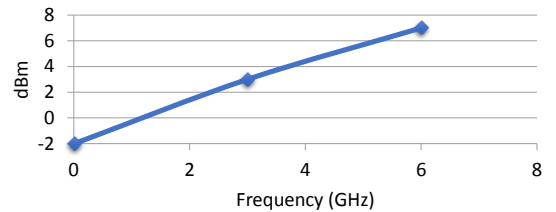
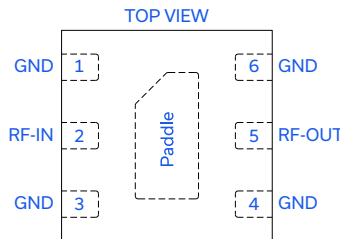
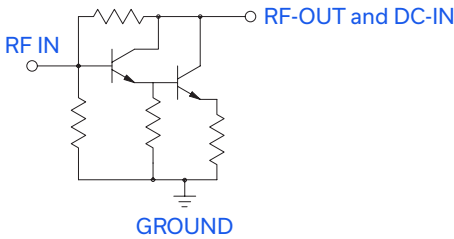

Fig 3. Power Input vs. Frequency

### SIMPLIFIED SCHEMATIC AND PAD DESCRIPTION



Function	Pad Number	Description
RF-IN	2	RF input pin. This pin requires the use of an external DC blocking capacitor chosen for the frequency of operation.
RF-OUT and DC-IN	5	RF output and bias pin. DC voltage is present on this pin; therefore a DC blocking capacitor is necessary for proper operation. An RF choke is needed to feed DC bias without loss of RF signal due to the bias connection, as shown in "Recommended Application Circuit".
GND	Paddle	Connections to ground.
NC	1,3,4,6	No connection. Use via holes as shown in "Suggested Layout for PCB Design" to reduce ground path inductance for best performance.



### CHARACTERIZATION TEST CIRCUIT

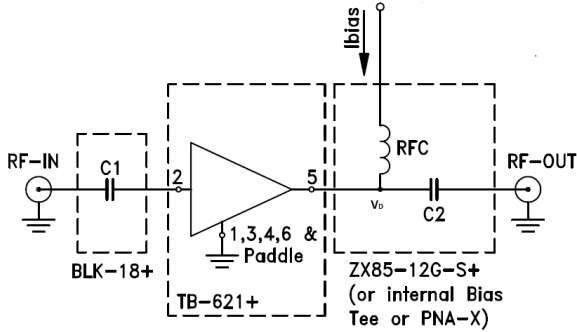

Fig 1. Block Diagram of Test Circuit used for characterization. (DUT soldered on Mini-Circuits Test Board TB-621+.

Gain, Return Loss, Output Power at 1 dB Compression (P1 dB), Output IP3 (OIP3) and Noise Figure measured using key signal N5242A, PNA-X microwave network analyzer.

Conditions:

1.  $I_{bias}=16mA$
2. Gain and Return loss: -25dBm
3. Output IP3: Two tones, spaced 1 MHz apart, -8 dBm/tone at output.

### RECOMMENDED APPLICATION CIRCUIT

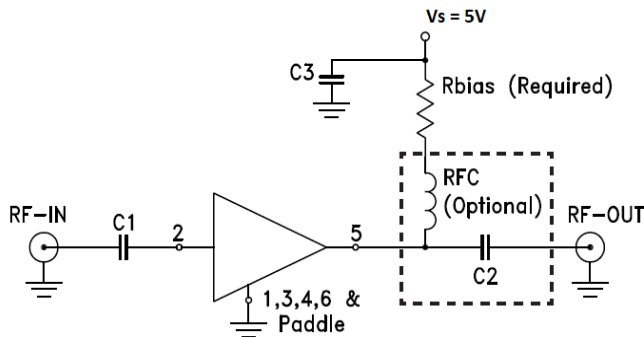

Component	Value	Size	Part Number	Manufacturer
C1, C2	2400 pF	0805	—	Various
RF C	—	0.15"X0.15"	TCCH-80+	Mini-Circuits
Rbias	93.1Ω	0402	—	Various
C3	0.1μF	0805	—	Various

Fig 2. Evaluation Board TB-899+ includes case, connectors and components soldered to PCB.

### PRODUCT MARKING

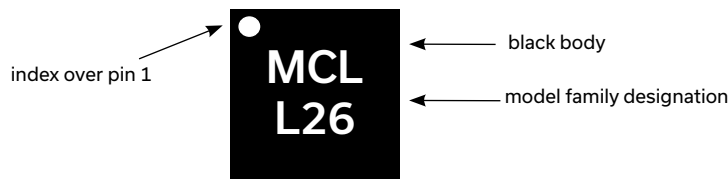

Marking may contain other features or characters for internal lot control



**SURFACE MOUNT**

# Monolithic Amplifier

**LEE2-6+**

Mini-Circuits

50Ω DC to 7 GHz

**ADDITIONAL DETAILED TECHNICAL INFORMATION IS AVAILABLE ON OUR DASH BOARD. TO ACCESS [CLICK HERE](#)**

<b>Performance Data</b>	Data Table Swept Graphs S-Parameter (S2P Files) Data Set (.zip file)
<b>Case Style</b>	MC1630-1 Plastic package, exposed paddle, lead finish: Matte-Tin
<b>Tape &amp; Reel</b> Standard quantities available on reel	F66 7" reels with 20, 50, 100, 200, 500 or 2K devices
<b>Suggested Layout for PCB Design</b>	PL-349
<b>Evaluation Board</b>	TB-899+
<b>Environmental Ratings</b>	ENV08T1

### ESD RATING

Human Body Model (HBM): Class 1C (1000 to <2000V) in accordance with ANSI/ESD STM 5.1 - 2001

Machine Model (MM): Class M2 (100V) in accordance with ANSI/ESD STM5.2-1999

### MSL RATING

Moisture Sensitivity: MSL1 in accordance with IPC/JEDEC J-STD-020D

### MSL TEST FLOW CHART

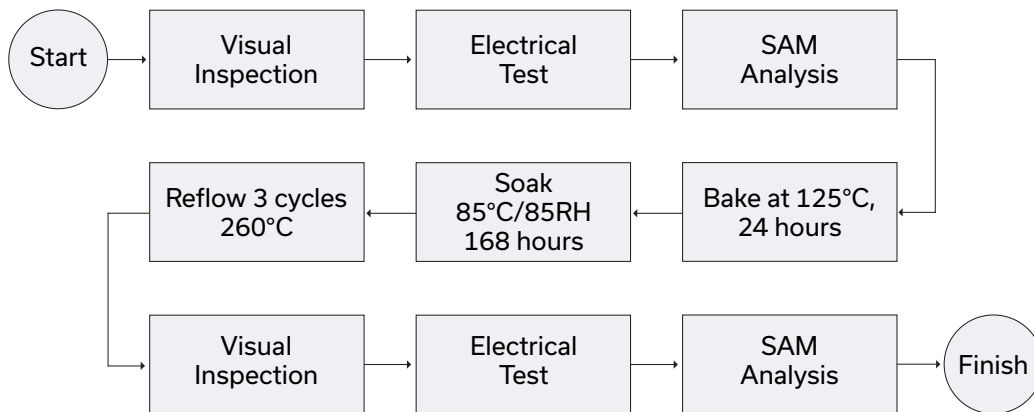

#### NOTES

- A. Performance and quality attributes and conditions not expressly stated in this specification document are intended to be excluded and do not form a part of this specification document.
- B. Electrical specifications and performance data contained in this specification document are based on Mini-Circuit's applicable established test performance criteria and measurement instructions.
- C. The parts covered by this specification document are subject to Mini-Circuits standard limited warranty and terms and conditions (collectively, "Standard Terms"); Purchasers of this part are entitled to the rights and benefits contained therein. For a full statement of the standard terms and the exclusive rights and remedies thereunder, please visit Mini-Circuits' website at [www.minicircuits.com/terms/viewterm.html](http://www.minicircuits.com/terms/viewterm.html)

