

OSRAM LE RTDUW S2WP

Datasheet

Published by **ams-OSRAM AG**

Tobelbader Strasse 30, 8141 Premstaetten, Austria

Phone +43 3136 500-0

ams-osram.com

© All rights reserved



OSRAM OSTAR® Stage

LE RTDUW S2WP

Outstanding brightness and luminance due to surface emission and low Rth

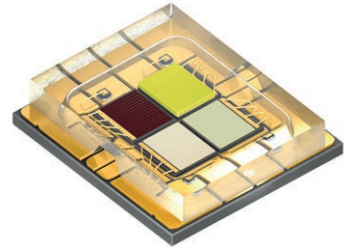

Applications

- Entertainment

Features

- Package: compact lightsource in multi chip SMT technology with glass window on top
- Chip technology: Thinfilm / UX:3
- Typ. Radiation: 120° (Lambertian emitter)
- Color: $\lambda_{\text{dom}} = 625 \text{ nm}$ (● red); $\lambda_{\text{dom}} = 530 \text{ nm}$ (● true green); $\lambda_{\text{dom}} = 453 \text{ nm}$ (● deep blue); Cx = 0.321, Cy = 0.327 acc. to CIE 1931 (● ultra white)
- Corrosion Robustness Class: 3B
- ESD: 2 kV acc. to ANSI/ESDA/JEDEC JS-001 (HBM, Class 2)

Ordering Information

Type	Brightness ¹⁾	Ordering Code
LERTDUWS2WP-LAMB-1+NAPA-P+ABBB-P+NBPB-BQ		Q65112A5475
● red	● $\Phi_V = 140 \dots 280 \text{ lm}$ ($I_F = 1400 \text{ mA}$)	
● true green	● $\Phi_V = 355 \dots 710 \text{ lm}$ ($I_F = 1400 \text{ mA}$)	
● deep blue	● $\Phi_E = 1800 \dots 2800 \text{ mW}$ ($I_F = 1400 \text{ mA}$)	
● ultra white	● $\Phi_V = 450 \dots 710 \text{ lm}$ ($I_F = 1400 \text{ mA}$)	
LERTDUWS2WP-LBMB-1+NBPB-P+BABB-P+PAPB-BQ		Q65113A5243
● red	● $\Phi_V = 112 \dots 280 \text{ lm}$ ($I_F = 1400 \text{ mA}$)	
● true green	● $\Phi_V = 280 \dots 560 \text{ lm}$ ($I_F = 1400 \text{ mA}$)	
● deep blue	● $\Phi_E = 1400 \dots 2800 \text{ mW}$ ($I_F = 1400 \text{ mA}$)	
● ultra white	● $\Phi_V = 355 \dots 710 \text{ lm}$ ($I_F = 1400 \text{ mA}$)	

Maximum Ratings

Parameter	Symbol		Values	Values	Values	Values
			● red	● true green	● deep blue	● ultra white
Operating Temperature	T_{op}	min.	-40 °C	-40 °C	-40 °C	-40 °C
		max.	85 °C	85 °C	85 °C	85 °C
Storage Temperature	T_{stg}	min.	-40 °C	-40 °C	-40 °C	-40 °C
		max.	85 °C	85 °C	85 °C	85 °C
Junction Temperature	T_j	max.	125 °C	125 °C	125 °C	125 °C
Forward Current $T_s = 25\text{ °C}$	I_F	min.	40 mA	40 mA	40 mA	40 mA
		max.	5000 mA	5000 mA	5000 mA	5000 mA
ESD withstand voltage acc. to ANSI/ESDA/ JEDEC JS-001 (HBM, Class 2)	V_{ESD}		2 kV	2 kV	2 kV	2 kV
Reverse current ²⁾	I_R	max.	200 mA	200 mA	200 mA	200 mA

Characteristics

$I_F = 1400 \text{ mA}$; $T_S = 25 \text{ °C}$

Parameter	Symbol		Values			
			● red	● true green	● deep blue	● ultra white
Chromaticity Coordinate ³⁾	Cx	typ.				0.321
	Cy	typ.				0.327
Peak Wavelength	λ_{peak}	typ.	632 nm	520 nm	449 nm	443.0 nm
Dominant Wavelength ⁴⁾	λ_{dom}	min.	620 nm	524 nm	449 nm	
		typ.	625 nm	530 nm	453 nm	
		max.	632 nm	536 nm	457 nm	
Spectral bandwidth at 50% $I_{\text{rel,max}}$	$\Delta\lambda$	typ.	18 nm	30 nm	20 nm	
Viewing angle at 50% I_V	2ϕ	typ.	120 °	120 °	120 °	130 °
Radiating surface For value(s) see red column, all chips operated simultaneously	A_{color}	typ.	2.5 x 3.2 mm ²			
Partial Flux acc. CIE 127:2007 ⁵⁾	$\Phi_{\text{E/V}, 120^\circ}$	typ.	0.82	0.82	0.82	0.77
$\Phi_{\text{E/V } 120^\circ} = x * \Phi_{\text{E/V } 180^\circ}$						
Forward Voltage ⁶⁾ $I_F = 1400 \text{ mA}$	V_F	min.	1.90 V	2.20 V	2.80 V	2.80 V
		typ.	2.35 V	2.80 V	3.00 V	3.00 V
		max.	2.80 V	3.20 V	3.50 V	3.50 V
Reverse voltage (ESD device)	$V_{\text{R ESD}}$	min.	45 V	45 V	45 V	45 V
Reverse voltage ²⁾ $I_R = 20 \text{ mA}$	V_R	max.	1.2 V	1.2 V	1.2 V	1.2 V
Real thermal resistance junction/solderpoint ⁷⁾ For value(s) see red column, all chips operated simultaneously	$R_{\text{thJS real}}$	typ.	0.70 K / W			
		max.	0.80 K / W			
Electrical thermal resistance junction/solderpoint ⁷⁾ With efficiency $\eta_e = 29\%$; for value(s) see red column, all chips operated simultaneously	$R_{\text{thJS elec.}}$	typ.	0.50 K / W			
		max.	0.57 K / W			

Brightness Groups

Color of emission	Group	Luminous Flux ¹⁾ $I_F = 1400 \text{ mA}$ min. Φ_V	Luminous Flux ¹⁾ $I_F = 1400 \text{ mA}$ max. Φ_V
• red	LA	112 lm	140 lm
• red	LB	140 lm	180 lm
• red	MA	180 lm	224 lm
• red	MB	224 lm	280 lm
• true green	NA	280 lm	355 lm
• true green	NB	355 lm	450 lm
• true green	PA	450 lm	560 lm
• true green	PB	560 lm	710 lm
• deep blue	AB	1400 mW	1800 mW
• deep blue	BA	1800 mW	2240 mW
• deep blue	BB	2240 mW	2800 mW
• ultra white	NB	355 lm	450 lm
• ultra white	PA	450 lm	560 lm
• ultra white	PB	560 lm	710 lm

Wavelength Groups

- true green

Group	Dominant Wavelength ⁴⁾ min. λ_{dom}	Dominant Wavelength ⁴⁾ max. λ_{dom}
3	524 nm	530 nm
4	530 nm	536 nm

Wavelength Groups

- deep blue

Group	Dominant Wavelength ⁴⁾ min. λ_{dom}	Dominant Wavelength ⁴⁾ max. λ_{dom}
3	449 nm	453 nm
4	453 nm	457 nm

Chromaticity Coordinate Groups

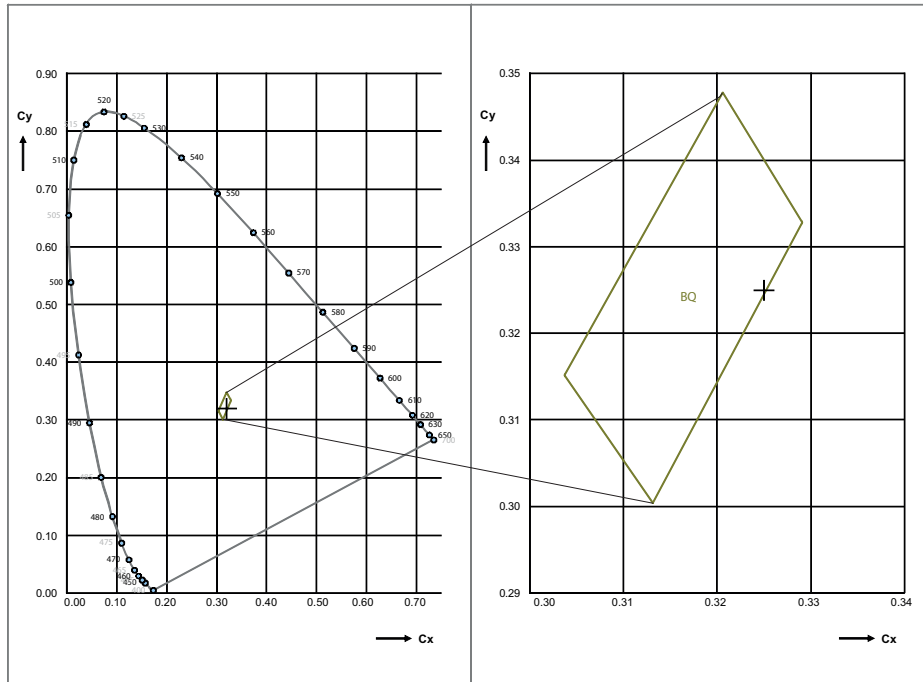

Chromaticity Coordinate Groups

- ultra white

Group	Cx	Cy
BQ	0.3037	0.3151
	0.3206	0.3478
	0.3291	0.3328
	0.3132	0.3004

Group Name on Label

Example: LA-1+NA-3+AB-3+NB-BQ

Color	Brightness
● red	LA
● true green	NA
● deep blue	AB
● ultra white	NB

Relative Spectral Emission ⁵⁾

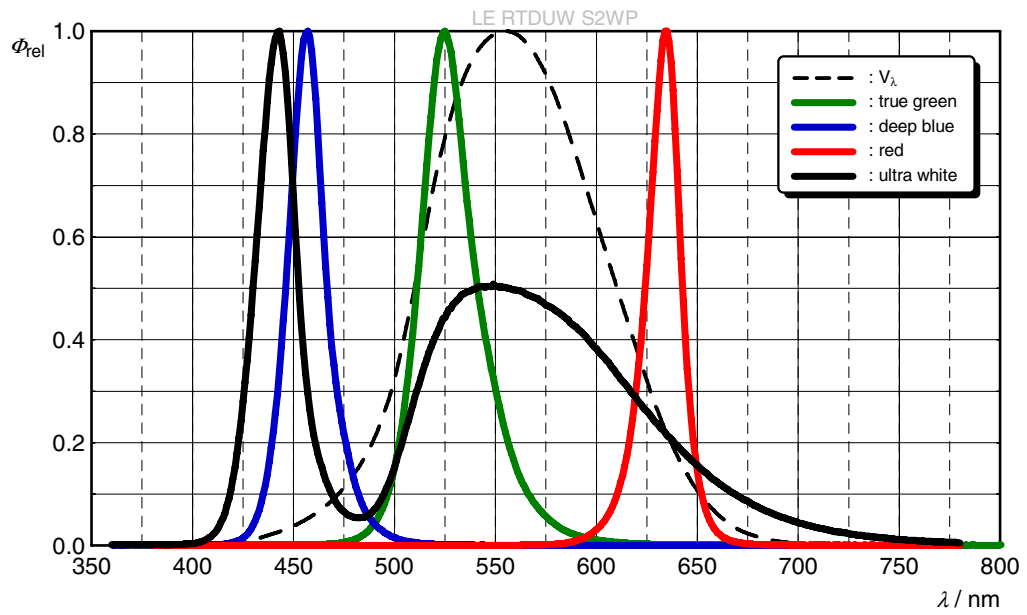

Radiation Characteristics ⁵⁾

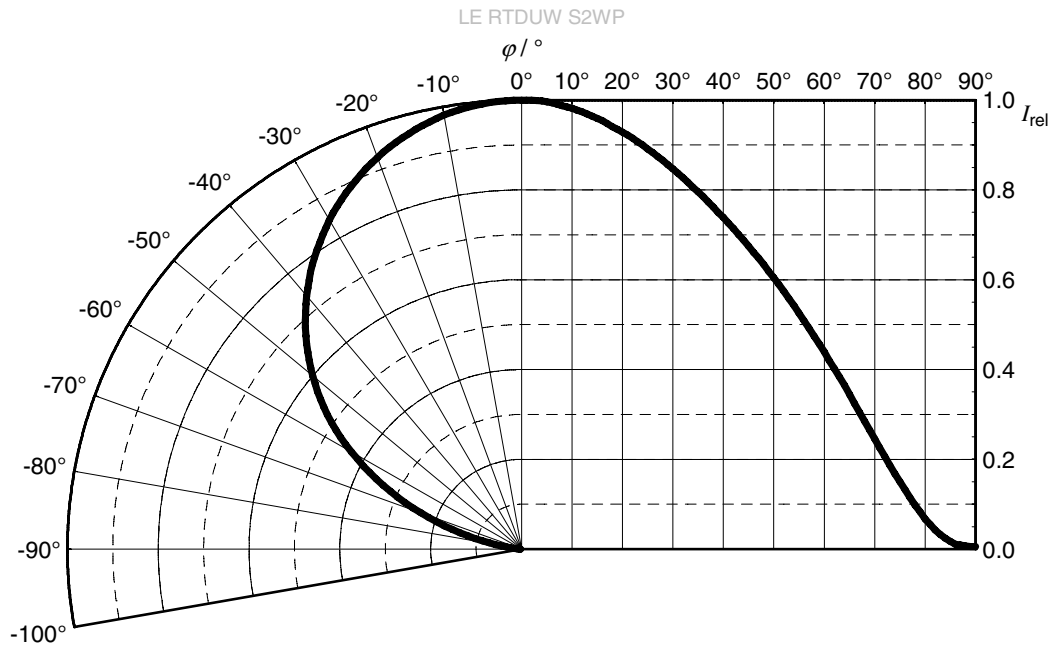

Radiation Characteristics ⁵⁾

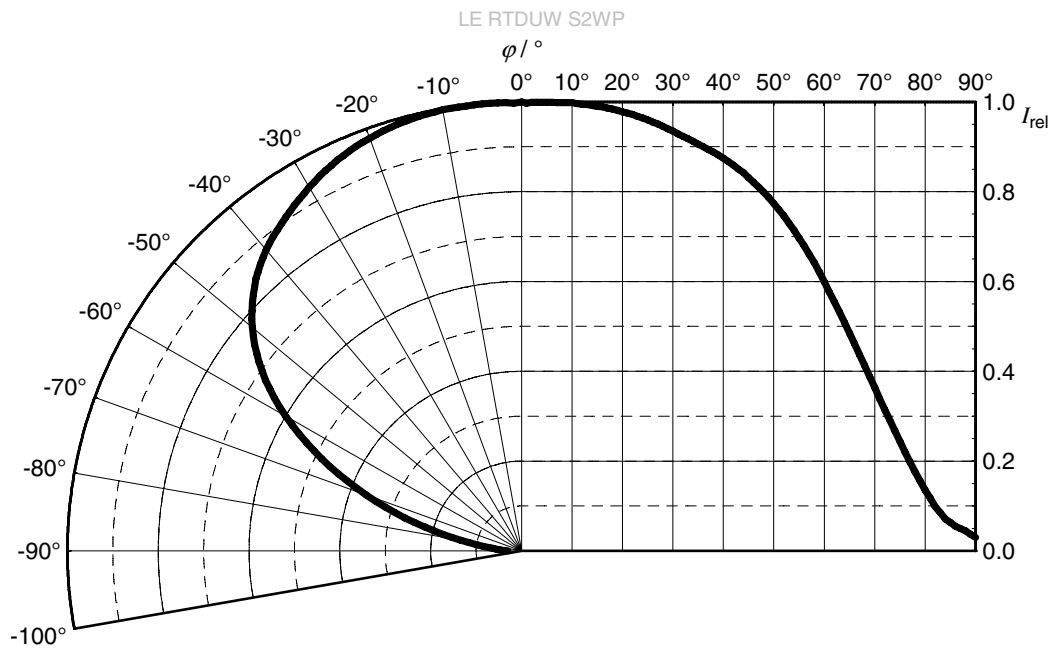

Relative Partial Flux ⁵⁾

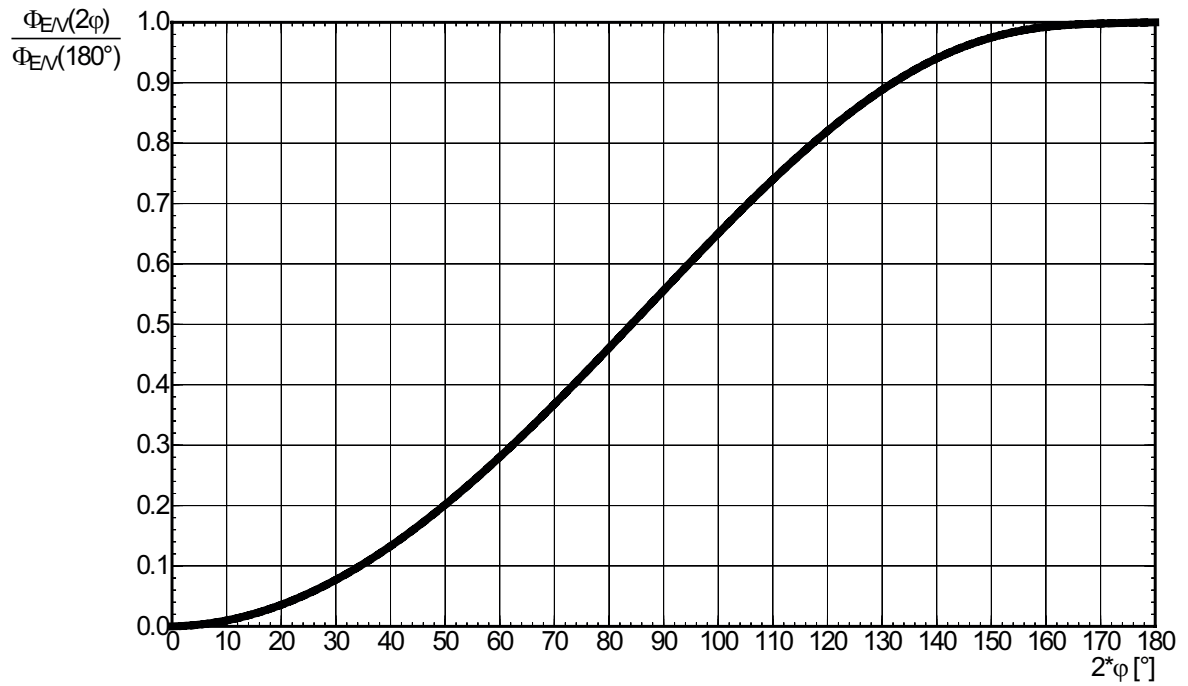

Relative Partial Flux ⁵⁾

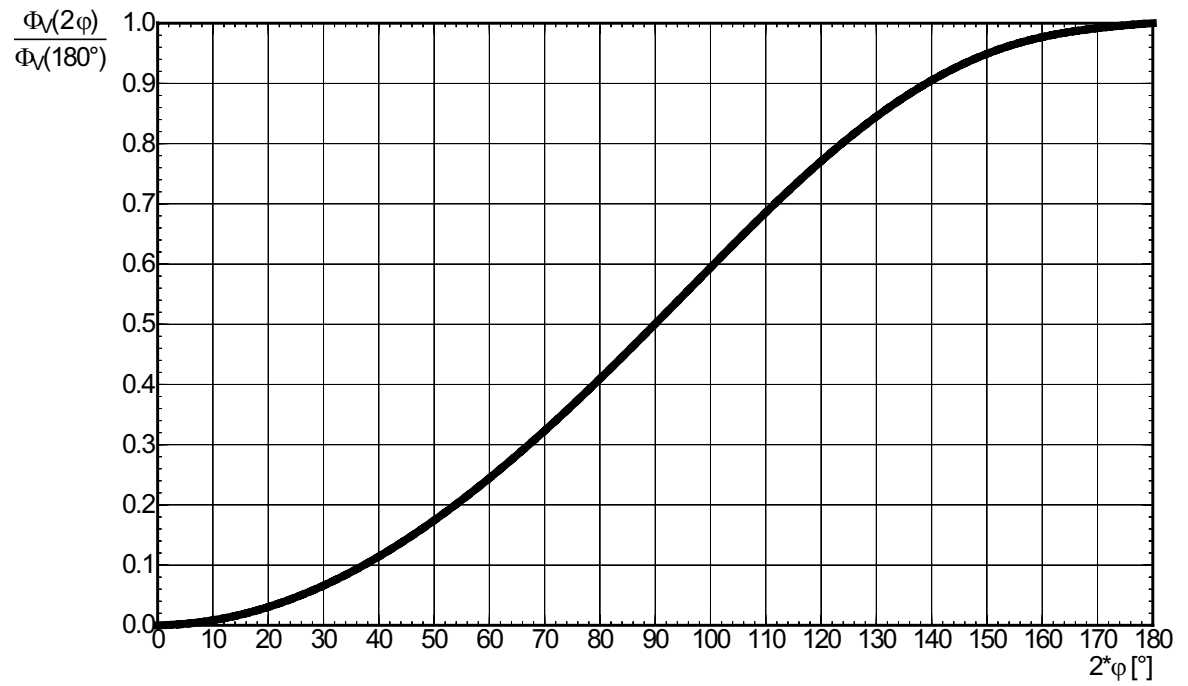

Forward current 5), 8)

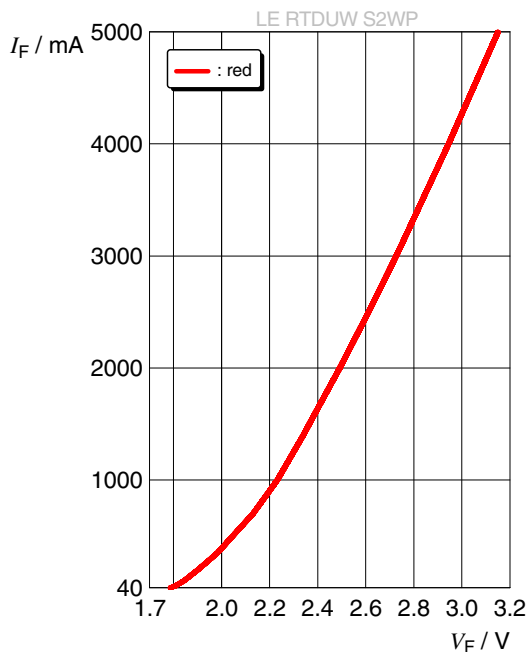

Forward current 5)

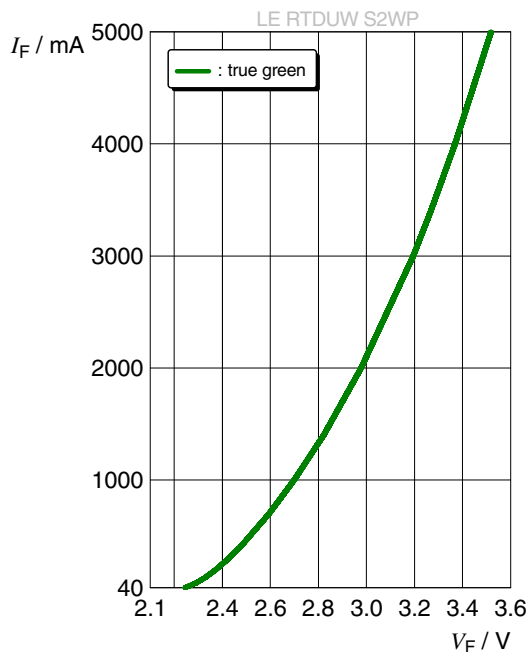

Forward current 5), 8)

$I_F = f(V_F); T_J = 25\text{ °C}$

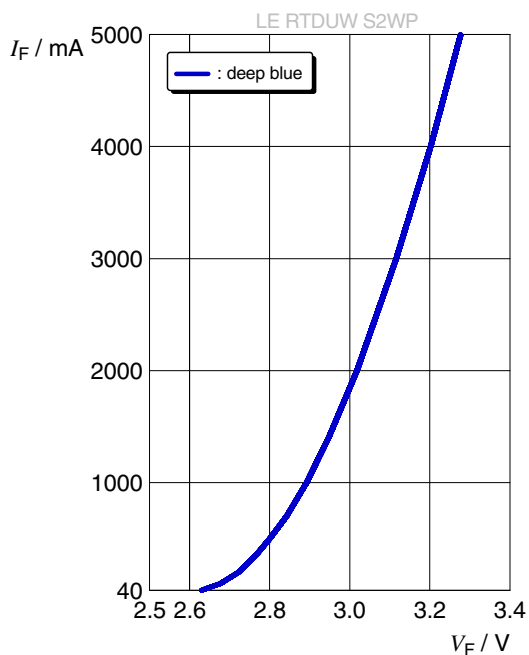

Forward current 5), 8)

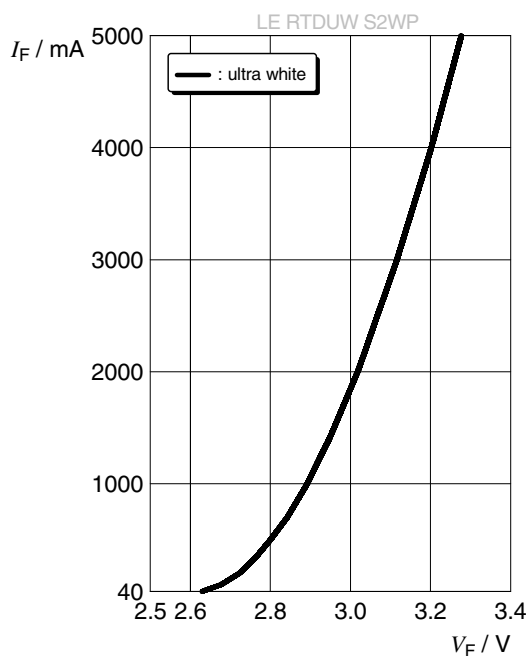

Relative Luminous Flux 5), 8)

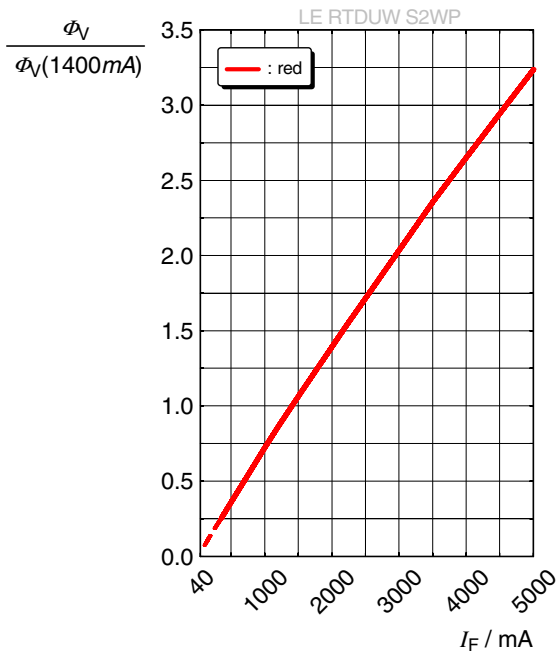

Relative Luminous Flux 5), 8)

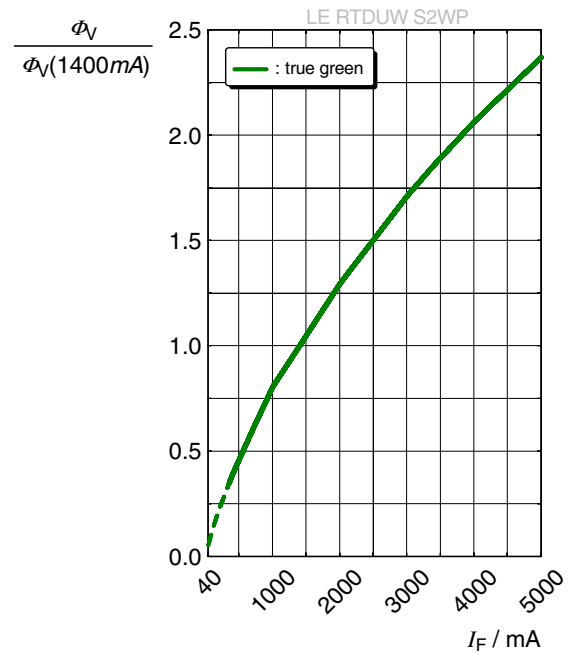

Relative Radiant Power 5), 8)

$\Phi_E / \Phi_E(1400 \text{ mA}) = f(I_F); T_J = 25 \text{ }^\circ\text{C}$

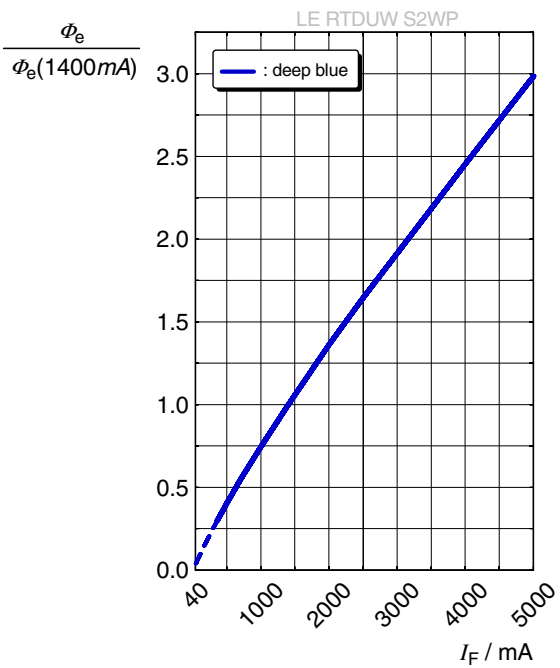

Relative Luminous Flux 5), 8)

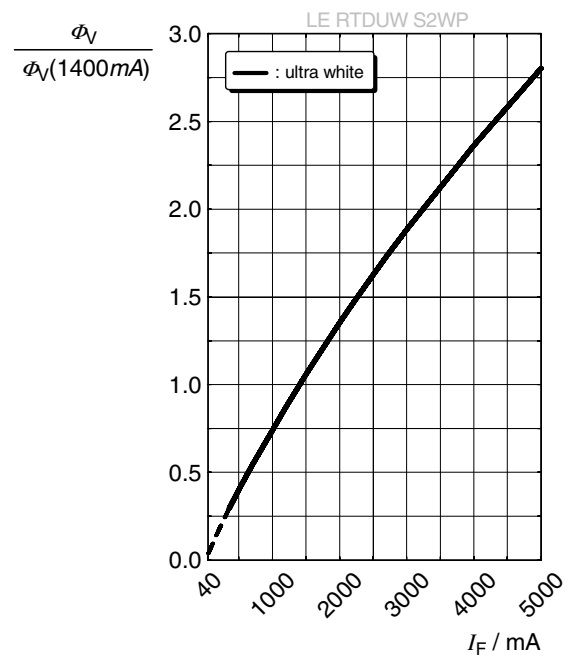

Dominant Wavelength ⁵⁾

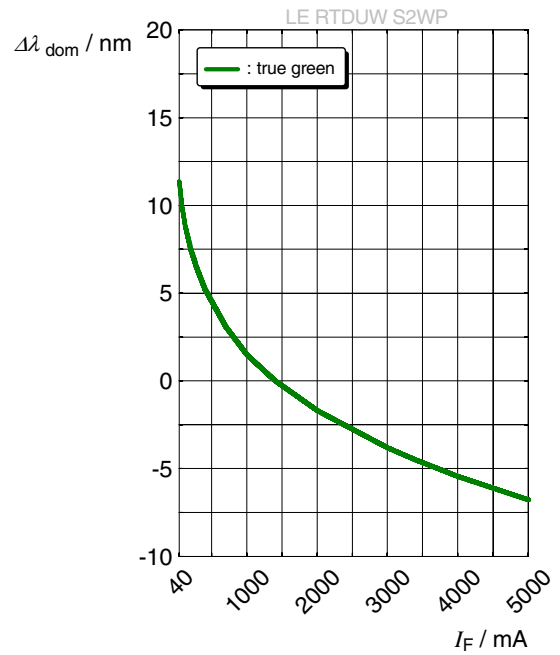

Dominant Wavelength ⁵⁾

$$\Delta\lambda_{\text{dom}} = f(I_F); T_J = 25\text{ }^\circ\text{C}$$

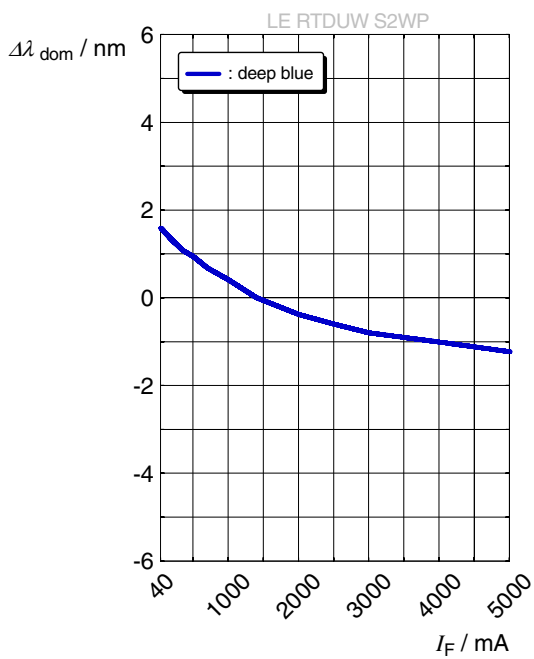

Chromaticity Coordinate Shift ⁵⁾

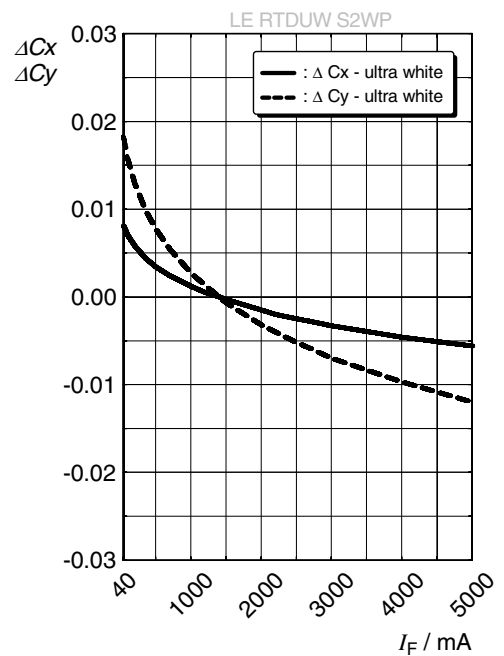

Forward Voltage ⁵⁾

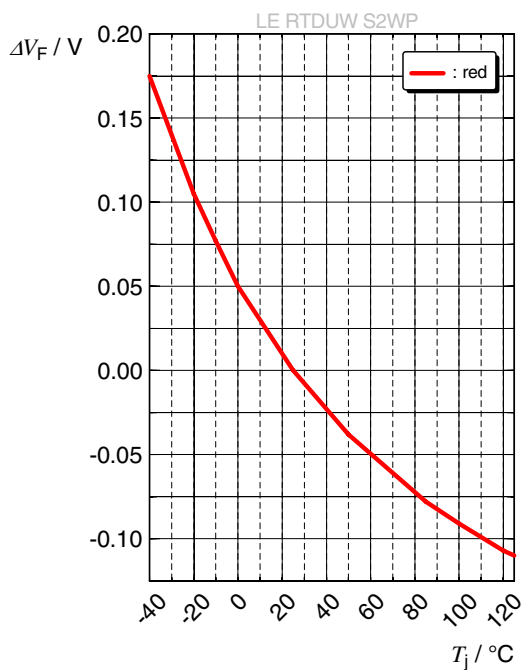

Forward Voltage ⁵⁾

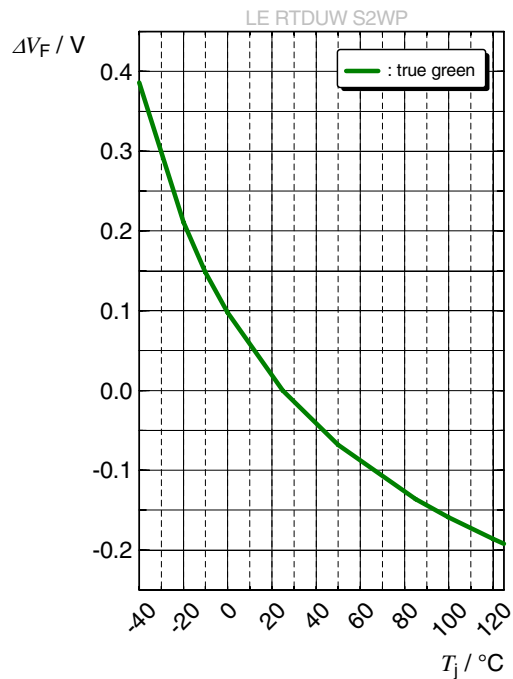

Forward Voltage ⁵⁾

$\Delta V_F = V_F - V_F(25^\circ C) = f(T_j); I_F = 1400 \text{ mA}$

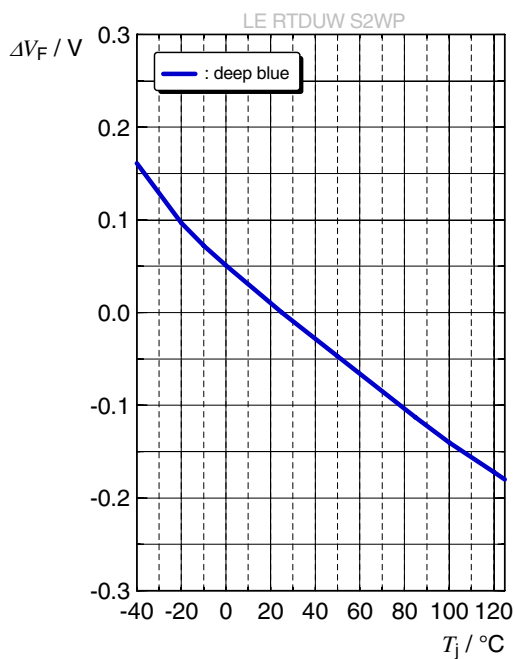

Forward Voltage ⁵⁾

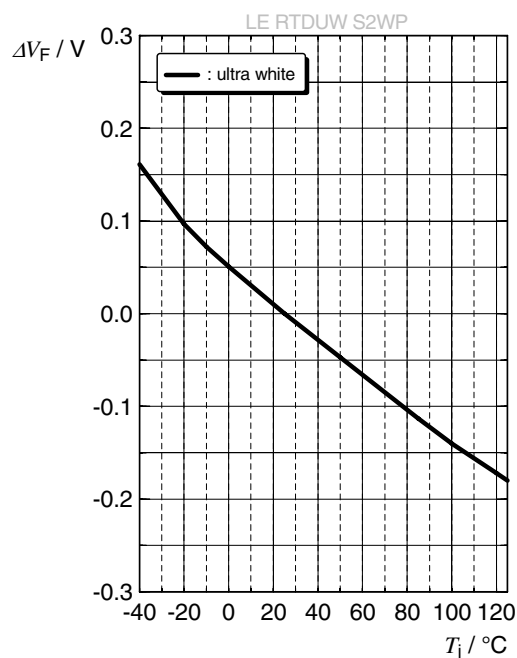

Relative Luminous Flux ⁵⁾

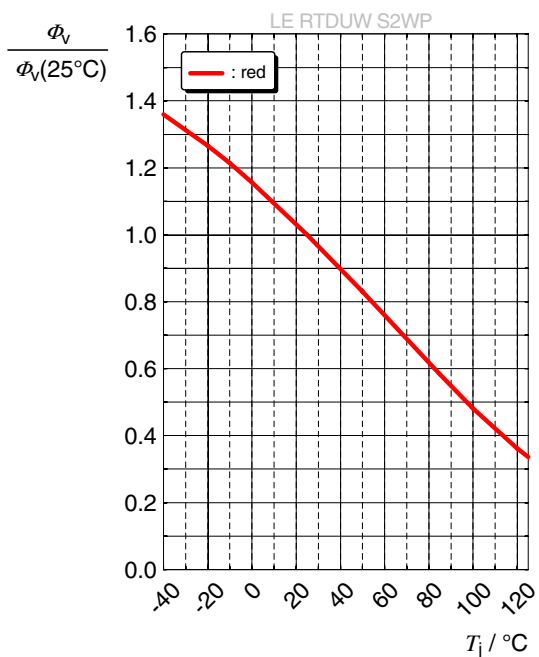

Relative Luminous Flux ⁵⁾

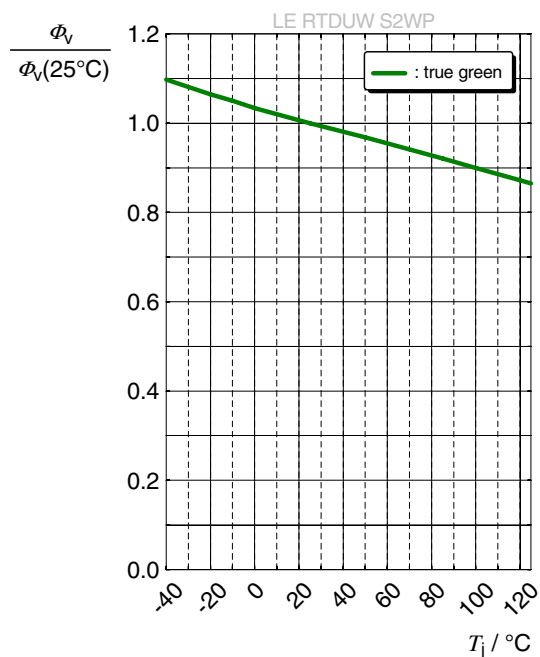

Relative Radiant Power ⁵⁾

$$\Phi_E / \Phi_E(25^\circ\text{C}) = f(T_j); I_F = 1400 \text{ mA}$$

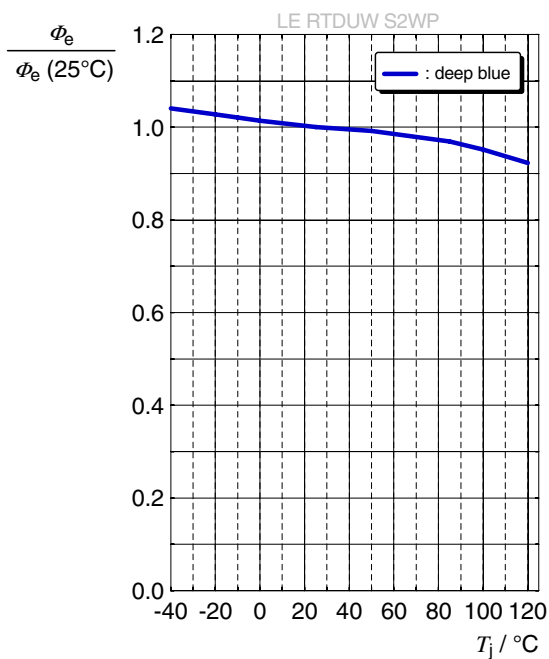

Relative Luminous Flux ⁵⁾

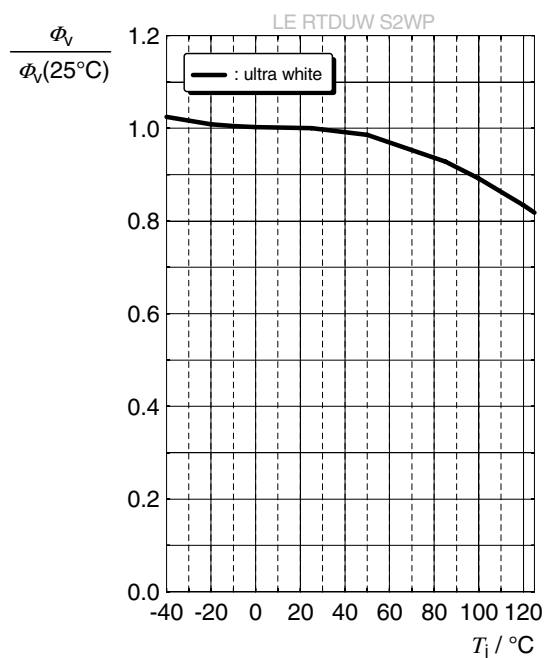

Dominant Wavelength ⁵⁾

$$\Delta\lambda_{\text{dom}} = \lambda_{\text{dom}} - \lambda_{\text{dom}}(25\text{ °C}) = f(T_j); I_F = 1400\text{ mA}$$

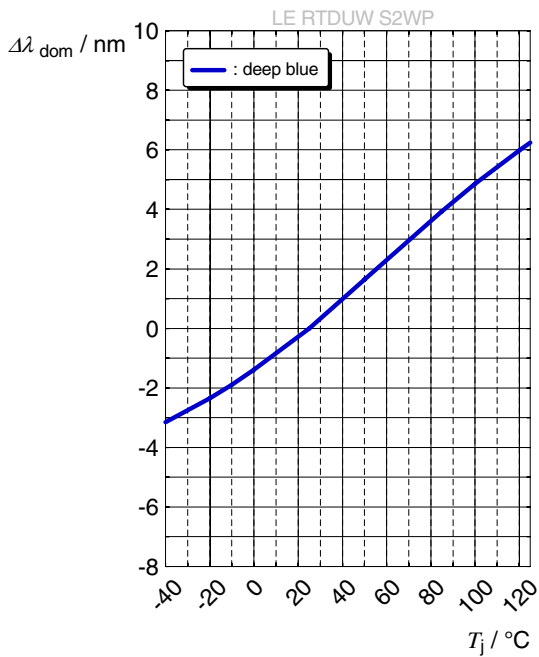

Dominant Wavelength ⁵⁾

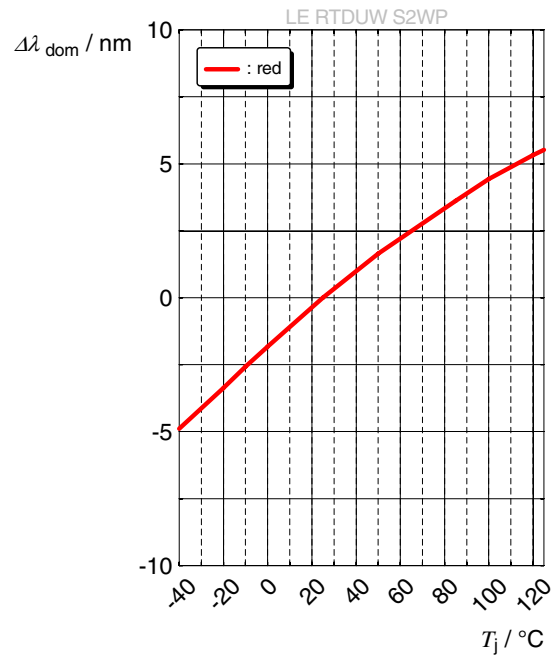

Dominant Wavelength ⁵⁾

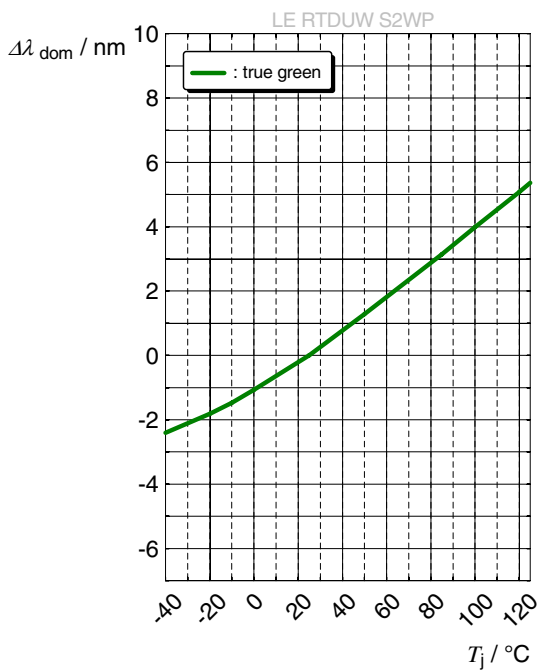

Chromaticity Coordinate Shift ⁵⁾

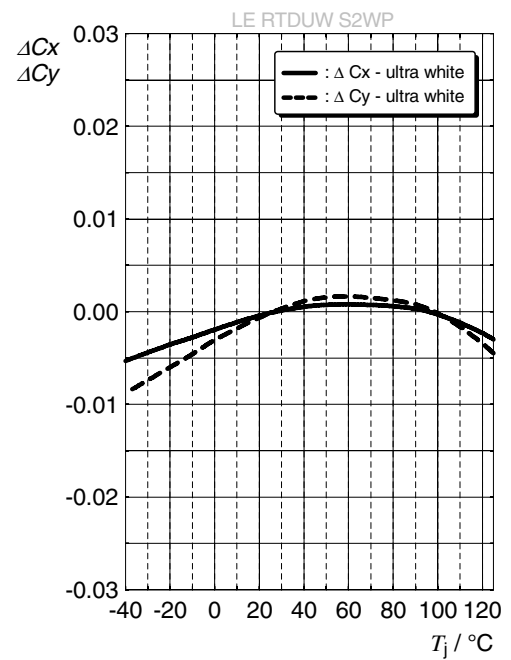

Max. Permissible Forward Current

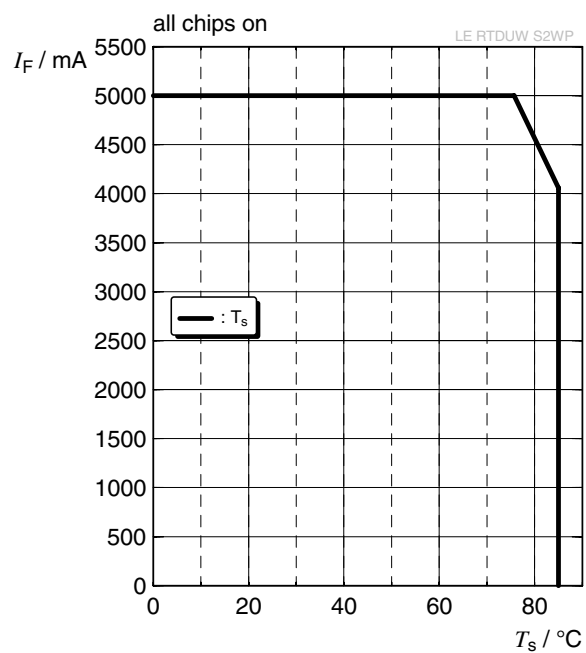

Dimensional Drawing ⁹⁾

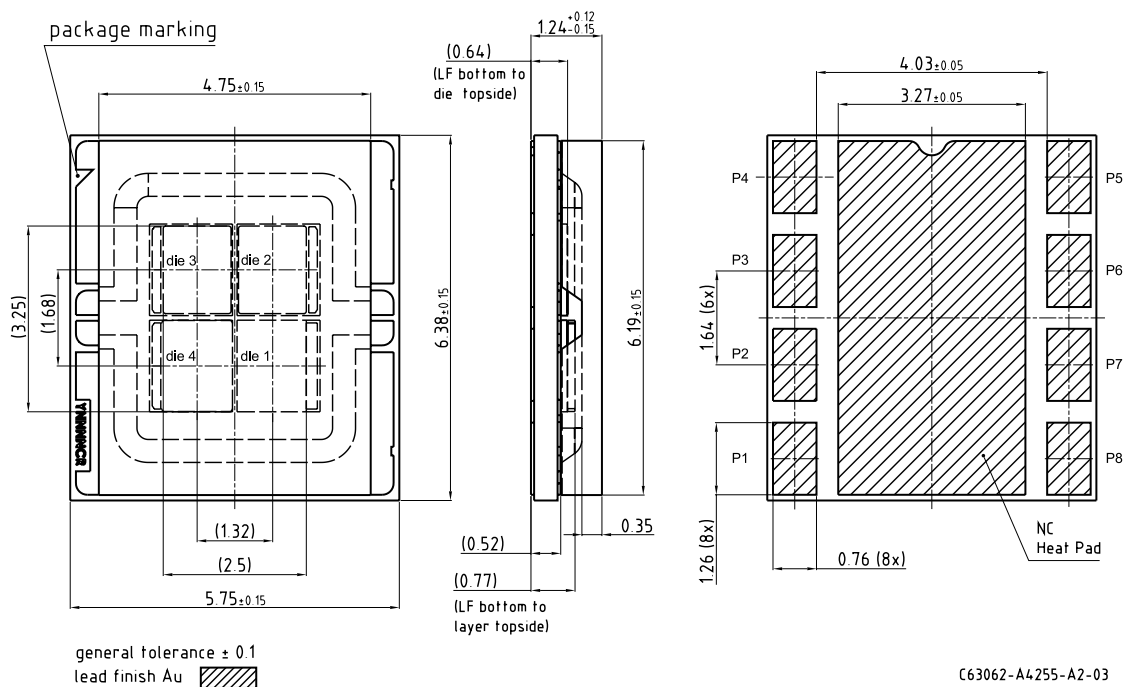

Further Information:

Approximate Weight: 127.0 mg

Corrosion test: Class: 3B
Test condition: 40°C / 90 % RH / 15 ppm H₂S / 14 days (stricter than IEC 60068-2-43)

ESD advice: The device is protected by ESD device which is connected in parallel to the Chip.

Electrical Internal Circuit

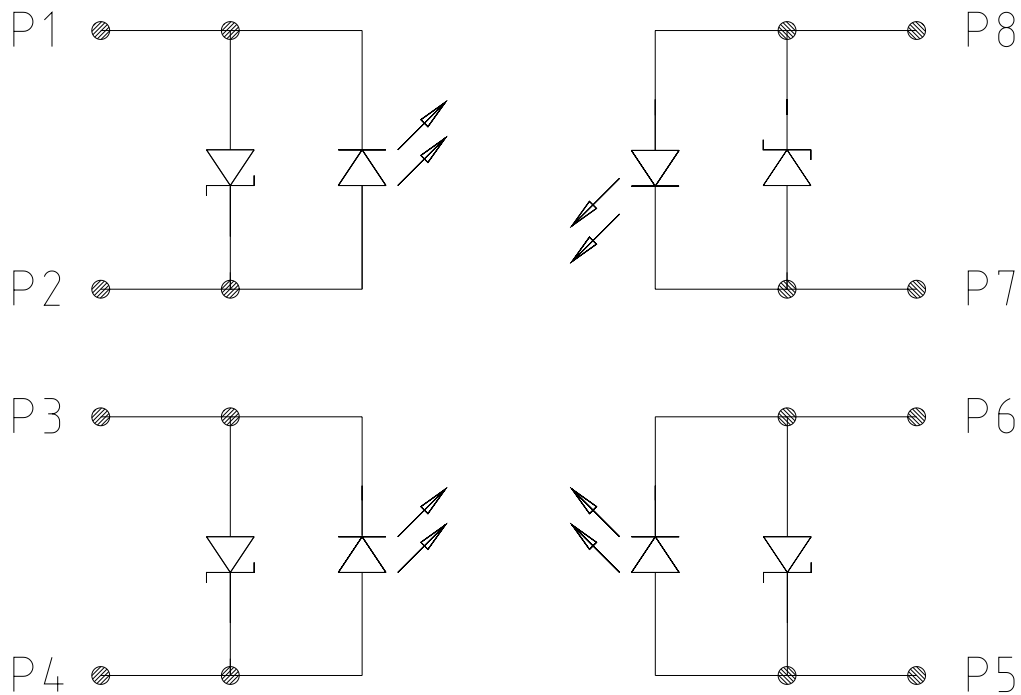

Pin	Description
P1	Cathode die 1 (red)
P2	Anode die 1 (red)
P3	Cathode die 2 (deep blue)
P4	Anode die 2 (deep blue)
P5	Anode die 3 (true green)
P6	Cathode die 3 (true green)
P7	Cathode die 4 (ultra white)
P8	Anode die 4 (ultra white)

Recommended Solder Pad ⁹⁾

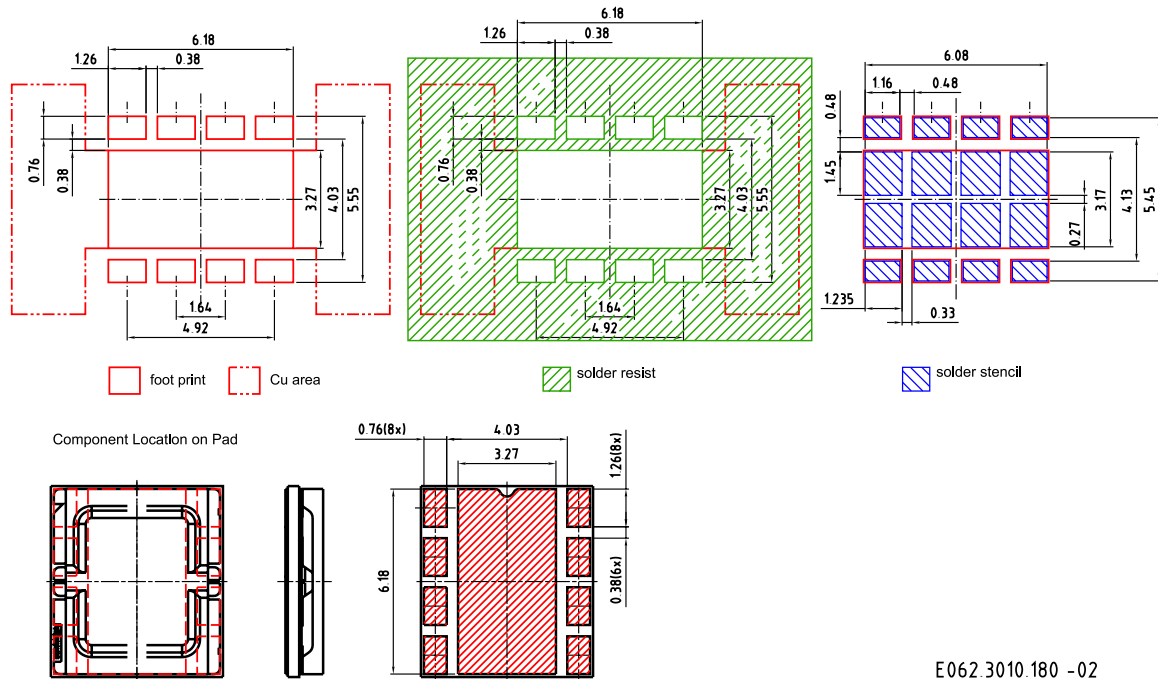

E062.3010.180 -02

For superior solder joint connectivity results we recommend soldering under standard nitrogen atmosphere. Package not suitable for any kind of wet cleaning or ultrasonic cleaning.

Reflow Soldering Profile

Product complies to MSL Level 2 acc. to JEDEC J-STD-020E

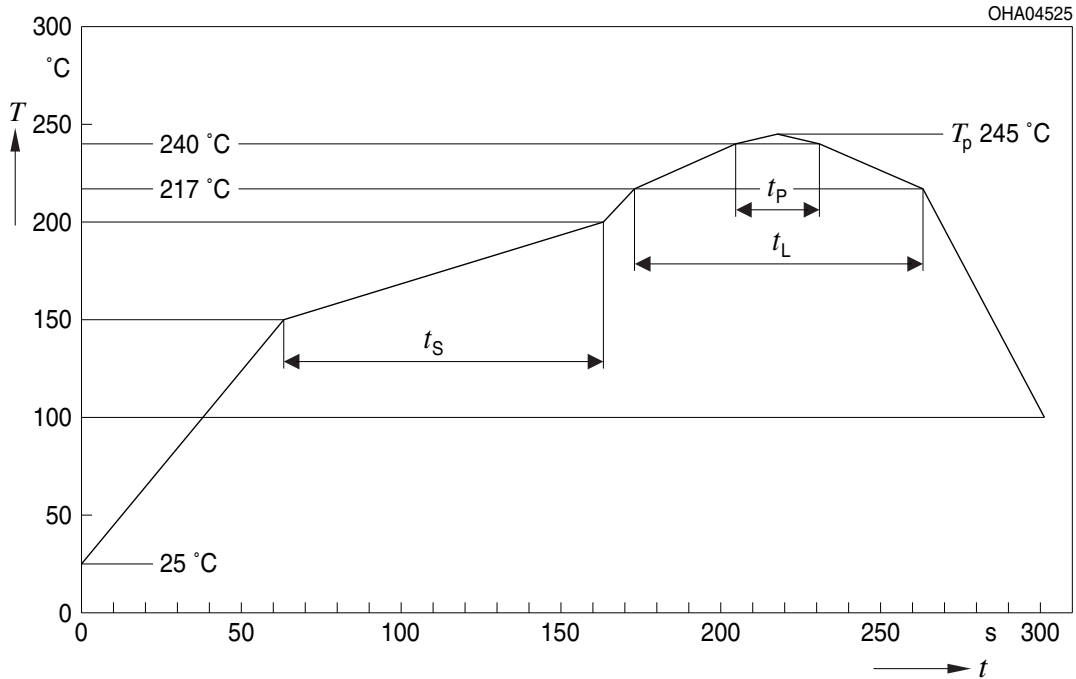

Profile Feature	Symbol	Pb-Free (SnAgCu) Assembly			Unit
		Minimum	Recommendation	Maximum	
Ramp-up rate to preheat ^{*)} 25 °C to 150 °C			2	3	K/s
Time t_s T_{Smin} to T_{Smax}	t_s	60	100	120	s
Ramp-up rate to peak ^{*)} T_{Smax} to T_p			2	3	K/s
Liquidus temperature	T_L		217		°C
Time above liquidus temperature	t_L		80	100	s
Peak temperature	T_p		245	260	°C
Time within 5 °C of the specified peak temperature $T_p - 5$ K	t_p	10	20	30	s
Ramp-down rate* T_p to 100 °C			3	6	K/s
Time 25 °C to T_p				480	s

All temperatures refer to the center of the package, measured on the top of the component

* slope calculation DT/Dt : Dt max. 5 s; fulfillment for the whole T-range

Taping ⁹⁾

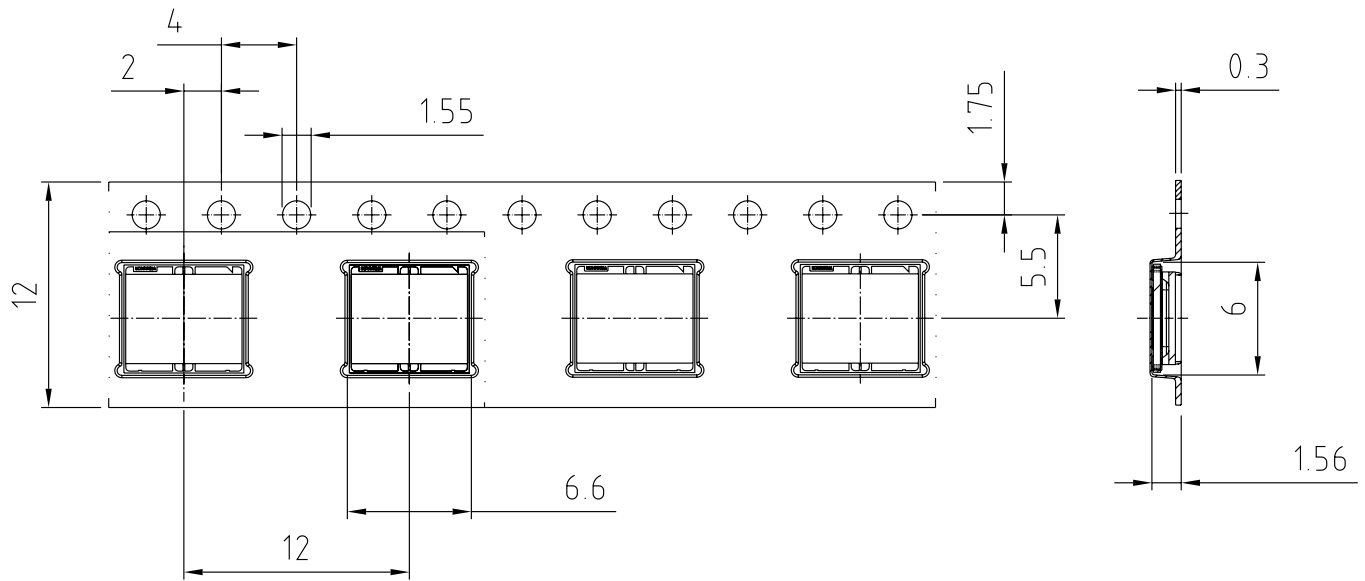

C63062-A4255-B5 -03

Tape and Reel ¹⁰⁾

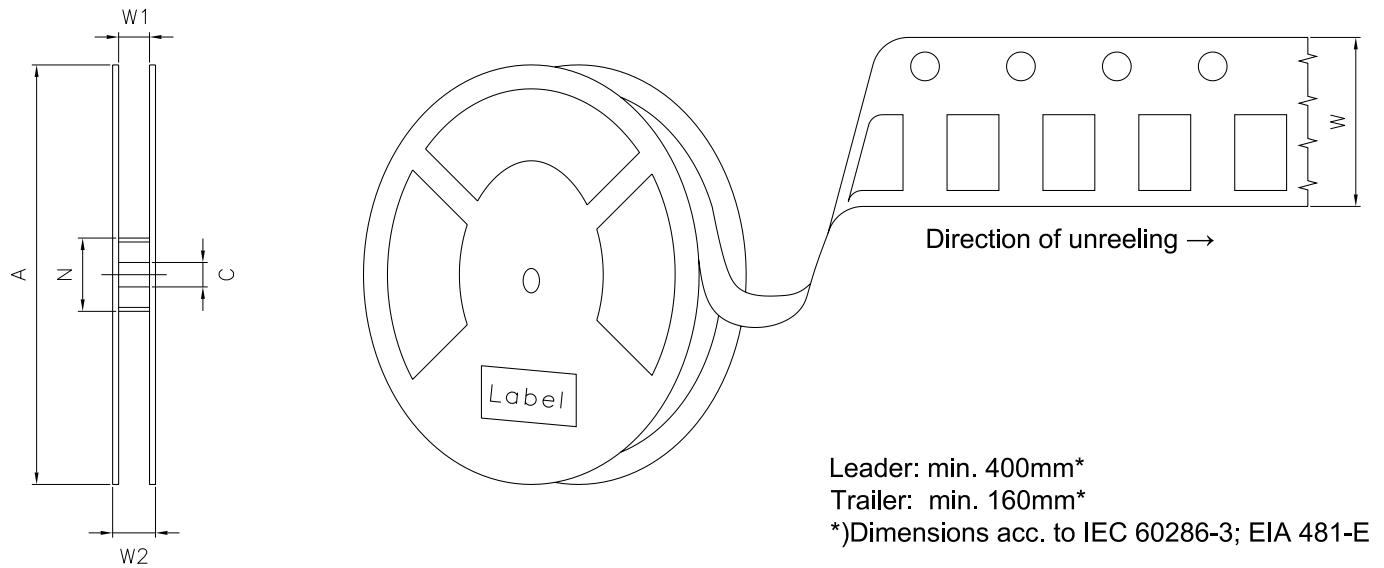

Reel Dimensions

A	W	N _{min}	W ₁	W _{2max}	Pieces per PU
180 mm	12 + 0.3 / - 0.1 mm	60 mm	12.4 + 2 mm	18.4 mm	500

Barcode-Product-Label (BPL)

OSRAM Opto Semiconductors LX XXXX BIN1: XX-XX-X-XXX-X

RoHS Compliant

(6P) BATCH NO: 1234567890

(1T) LOT NO: 1234567890 (9D) D/C: 1234

(X) PROD NO: 123456789(Q)QTY: 9999 (G) GROUP: XX-XX-X-X

ML Temp ST
X XXX °C X

Pack: RXX
DEMY XXX
X_X123_1234.1234 X

OHA04563

Dry Packing Process and Materials ⁹⁾

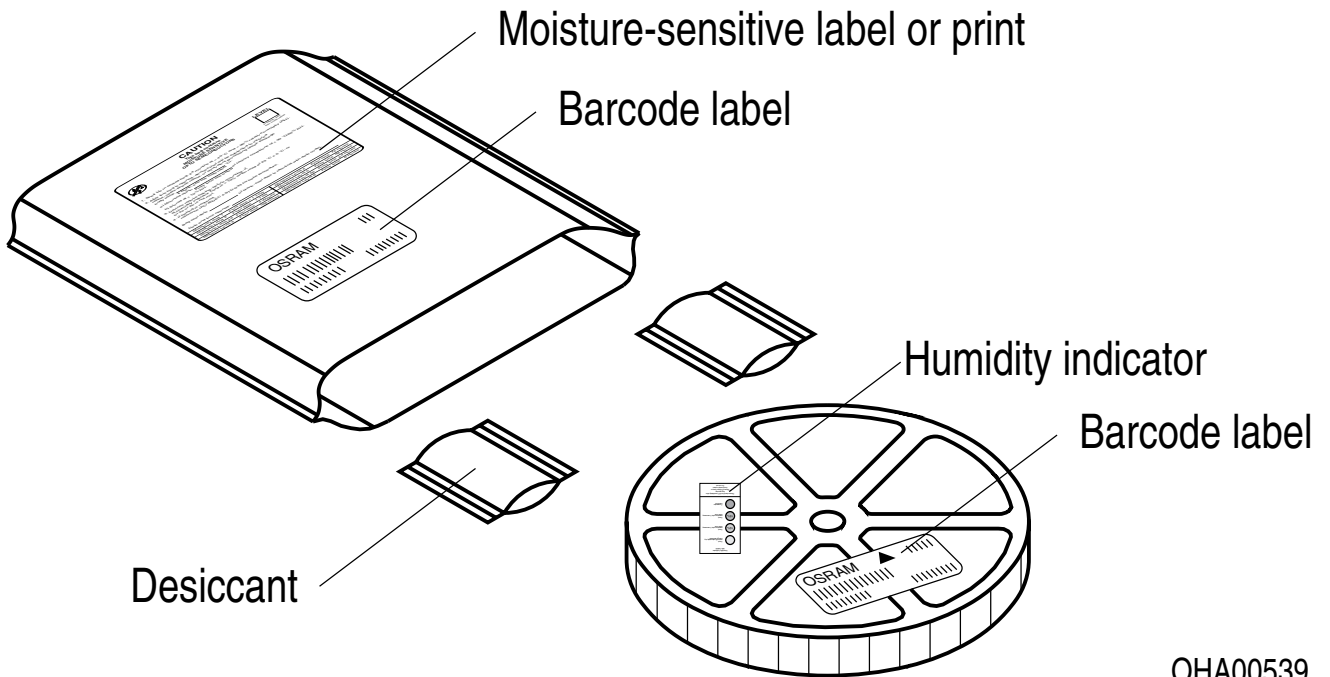

OHA00539

Moisture-sensitive product is packed in a dry bag containing desiccant and a humidity card according JEDEC-STD-033.

Notes

The evaluation of eye safety occurs according to the standard IEC 62471:2006 (photo biological safety of lamps and lamp systems). Within the risk grouping system of this IEC standard, the device specified in this data sheet fall into the class **moderate risk (exposure time 0.25 s)**. Under real circumstances (for exposure time, conditions of the eye pupils, observation distance), it is assumed that no endangerment to the eye exists from these devices. As a matter of principle, however, it should be mentioned that intense light sources have a high secondary exposure potential due to their blinding effect. When looking at bright light sources (e.g. headlights), temporary reduction in visual acuity and afterimages can occur, leading to irritation, annoyance, visual impairment, and even accidents, depending on the situation.

Subcomponents of this device contain, in addition to other substances, metal filled materials including silver. Metal filled materials can be affected by environments that contain traces of aggressive substances. Therefore, we recommend that customers minimize device exposure to aggressive substances during storage, production, and use. Devices that showed visible discoloration when tested using the described tests above did show no performance deviations within failure limits during the stated test duration. Respective failure limits are described in the IEC60810.

For further application related information please visit www.osram-os.com/appnotes

Disclaimer

Attention please!

The information describes the type of component and shall not be considered as assured characteristics. Terms of delivery and rights to change design reserved. Due to technical requirements components may contain dangerous substances.

For information on the types in question please contact our Sales Organization.

If printed or downloaded, please find the latest version on our website.

Packing

Please use the recycling operators known to you. We can also help you – get in touch with your nearest sales office. By agreement we will take packing material back, if it is sorted. You must bear the costs of transport. For packing material that is returned to us unsorted or which we are not obliged to accept, we shall have to invoice you for any costs incurred.

Product and functional safety devices/applications or medical devices/applications

Our components are not developed, constructed or tested for the application as safety relevant component or for the application in medical devices.

Our products are not qualified at module and system level for such application.

In case buyer – or customer supplied by buyer – considers using our components in product safety devices/ applications or medical devices/applications, buyer and/or customer has to inform our local sales partner immediately and we and buyer and /or customer will analyze and coordinate the customer-specific request between us and buyer and/or customer.

Glossary

- 1) **Brightness:** Brightness values are measured during a current pulse of typically 25 ms, with an internal reproducibility of $\pm 8\%$ and an expanded uncertainty of $\pm 11\%$ (acc. to GUM with a coverage factor of $k = 3$).
- 2) **Reverse Operation:** This product is intended to be operated applying a forward current within the specified range. Applying any continuous reverse bias or forward bias below the voltage range of light emission shall be avoided because it may cause migration which can change the electro-optical characteristics or damage the LED.
- 3) **Chromaticity coordinate groups:** Chromaticity coordinates are measured during a current pulse of typically 25 ms, with an internal reproducibility of ± 0.005 and an expanded uncertainty of ± 0.01 (acc. to GUM with a coverage factor of $k = 3$).
- 4) **Wavelength:** The wavelength is measured at a current pulse of typically 25 ms, with an internal reproducibility of ± 0.5 nm and an expanded uncertainty of ± 1 nm (acc. to GUM with a coverage factor of $k = 3$).
- 5) **Typical Values:** Due to the special conditions of the manufacturing processes of semiconductor devices, the typical data or calculated correlations of technical parameters can only reflect statistical figures. These do not necessarily correspond to the actual parameters of each single product, which could differ from the typical data and calculated correlations or the typical characteristic line. If requested, e.g. because of technical improvements, these typ. data will be changed without any further notice.
- 6) **Forward Voltage:** The forward voltage is measured during a current pulse of typically 8 ms, with an internal reproducibility of ± 0.05 V and an expanded uncertainty of ± 0.1 V (acc. to GUM with a coverage factor of $k = 3$).
- 7) **Thermal Resistance:** $R_{th\ max}$ is based on statistic values (6σ).
- 8) **Characteristic curve:** In the range where the line of the graph is broken, you must expect higher differences between single devices within one packing unit.
- 9) **Tolerance of Measure:** Unless otherwise noted in drawing, tolerances are specified with ± 0.1 and dimensions are specified in mm.
- 10) **Tape and Reel:** All dimensions and tolerances are specified acc. IEC 60286-3 and specified in mm.

Revision History

Version	Date	Change
1.5	2018-11-28	Characteristics
1.6	2018-11-29	Electrical Internal Circuit
1.7	2019-01-22	Maximum Ratings Electro - Optical Characteristics (Diagrams) Derating (Diagrams)
1.8	2019-02-04	Ordering Information
1.9	2019-06-06	Electro - Optical Characteristics (Diagrams)
1.11	2020-06-03	Schematic Transportation Box Dimensions of Transportation Box
1.12	2020-07-07	Characteristics
1.13	2021-07-14	Dimensional Drawing
1.14	2022-09-15	Characteristics New Layout Electro - Optical Characteristics (Diagrams)



EU RoHS and China RoHS compliant product

此产品符合欧盟 RoHS 指令的要求；
按照中国的相关法规和标准，
不含有毒有害物质或元素。

Published by ams-OSRAM AG

Tobelbader Strasse 30, 8141 Premstaetten, Austria

Phone +43 3136 500-0

ams-osram.com

© All rights reserved

am  **OSRAM**