



MICROCHIP

HV2070
Analog Switch
Evaluation Board
User's Guide

Note the following details of the code protection feature on Microchip devices:

- Microchip products meet the specification contained in their particular Microchip Data Sheet.
- Microchip believes that its family of products is one of the most secure families of its kind on the market today, when used in the intended manner and under normal conditions.
- There are dishonest and possibly illegal methods used to breach the code protection feature. All of these methods, to our knowledge, require using the Microchip products in a manner outside the operating specifications contained in Microchip's Data Sheets. Most likely, the person doing so is engaged in theft of intellectual property.
- Microchip is willing to work with the customer who is concerned about the integrity of their code.
- Neither Microchip nor any other semiconductor manufacturer can guarantee the security of their code. Code protection does not mean that we are guaranteeing the product as "unbreakable."

Code protection is constantly evolving. We at Microchip are committed to continuously improving the code protection features of our products. Attempts to break Microchip's code protection feature may be a violation of the Digital Millennium Copyright Act. If such acts allow unauthorized access to your software or other copyrighted work, you may have a right to sue for relief under that Act.

Information contained in this publication regarding device applications and the like is provided only for your convenience and may be superseded by updates. It is your responsibility to ensure that your application meets with your specifications. MICROCHIP MAKES NO REPRESENTATIONS OR WARRANTIES OF ANY KIND WHETHER EXPRESS OR IMPLIED, WRITTEN OR ORAL, STATUTORY OR OTHERWISE, RELATED TO THE INFORMATION, INCLUDING BUT NOT LIMITED TO ITS CONDITION, QUALITY, PERFORMANCE, MERCHANTABILITY OR FITNESS FOR PURPOSE. Microchip disclaims all liability arising from this information and its use. Use of Microchip devices in life support and/or safety applications is entirely at the buyer's risk, and the buyer agrees to defend, indemnify and hold harmless Microchip from any and all damages, claims, suits, or expenses resulting from such use. No licenses are conveyed, implicitly or otherwise, under any Microchip intellectual property rights unless otherwise stated.

Microchip received ISO/TS-16949:2009 certification for its worldwide headquarters, design and wafer fabrication facilities in Chandler and Tempe, Arizona; Gresham, Oregon and design centers in California and India. The Company's quality system processes and procedures are for its PIC® MCUs and dsPIC® DSCs, KEELOQ® code hopping devices, Serial EEPROMs, microperipherals, nonvolatile memory and analog products. In addition, Microchip's quality system for the design and manufacture of development systems is ISO 9001:2000 certified.

**QUALITY MANAGEMENT SYSTEM
CERTIFIED BY DNV
= ISO/TS 16949 =**

Trademarks

The Microchip name and logo, the Microchip logo, AnyRate, AVR, AVR logo, AVR Freaks, BeaconThings, BitCloud, CryptoMemory, CryptoRF, dsPIC, FlashFlex, flexPWR, Helder, JukeBlox, KEELOQ, KEELOQ logo, Klear, LANCheck, LINK MD, maXStylus, maXTouch, MediaLB, megaAVR, MOST, MOST logo, MPLAB, OptoLyzr, PIC, picoPower, PICSTART, PIC32 logo, Prochip Designer, QTouch, RightTouch, SAM-BA, SpyNIC, SST, SST Logo, SuperFlash, tinyAVR, UNI/O, and XMEGA are registered trademarks of Microchip Technology Incorporated in the U.S.A. and other countries.

ClockWorks, The Embedded Control Solutions Company, EtherSynch, Hyper Speed Control, HyperLight Load, IntelliMOS, mTouch, Precision Edge, and Quiet-Wire are registered trademarks of Microchip Technology Incorporated in the U.S.A.

Adjacent Key Suppression, AKS, Analog-for-the-Digital Age, Any Capacitor, AnyIn, AnyOut, BodyCom, chipKIT, chipKIT logo, CodeGuard, CryptoAuthentication, CryptoCompanion, CryptoController, dsPICDEM, dsPICDEM.net, Dynamic Average Matching, DAM, ECAN, EtherGREEN, In-Circuit Serial Programming, ICSP, Inter-Chip Connectivity, JitterBlocker, KlearNet, KlearNet logo, Mindi, MiWi, motorBench, MPASM, MPF, MPLAB Certified logo, MPLIB, MPLINK, MultiTRAK, NetDetach, Omniscient Code Generation, PICDEM, PICDEM.net, PICkit, PICTail, PureSilicon, QMatrix, RightTouch logo, REAL ICE, Ripple Blocker, SAM-ICE, Serial Quad I/O, SMART-I.S., SQI, SuperSwitcher, SuperSwitcher II, Total Endurance, TSHARC, USBCheck, VariSense, ViewSpan, WiperLock, Wireless DNA, and ZENA are trademarks of Microchip Technology Incorporated in the U.S.A. and other countries.

SQTP is a service mark of Microchip Technology Incorporated in the U.S.A.

Silicon Storage Technology is a registered trademark of Microchip Technology Inc. in other countries.

GestIC is a registered trademark of Microchip Technology Germany II GmbH & Co. KG, a subsidiary of Microchip Technology Inc., in other countries.

All other trademarks mentioned herein are property of their respective companies.

© 2017, Microchip Technology Incorporated, All Rights Reserved.
ISBN: 978-1-5224-2482-6



HV2070 ANALOG SWITCH EVALUATION BOARD USER'S GUIDE

Table of Contents

Preface	5
Introduction.....	5
Document Layout	5
Conventions Used in this Guide	6
Warranty Registration.....	6
Recommended Reading.....	7
The Microchip Web Site	7
Product Change Notification Service.....	7
Customer Support	7
Document Revision History	7
Chapter 1. Product Overview	
1.1 Introduction	9
1.2 HV2070 Device Short Overview	9
1.3 HV2070 Analog Switch Evaluation Board Features	9
1.4 What Is the HV2070 Analog Switch Evaluation Board?	10
1.5 HV2070 Analog Switch Evaluation Board Technical Parameters	10
1.6 HV2070 Analog Switch Evaluation Board Kit Contents	11
Chapter 2. Installation and Operation	
2.1 Getting Started	13
2.1.1 Additional Tools Required for Operation	13
2.2 HV MUX GUI Installation	13
2.3 HV2070 Analog Switch Evaluation Board Setup Procedure	17
2.3.1 Recommended Power-Up and Power-Down Sequences	18
2.4 Interface Connections	19
2.5 HV MUX Controller Board Setup Procedure	20
2.6 Testing the HV2070 Analog Switch Evaluation Board	21
2.6.1 HV2070 Individual Switching Mode Operation (STBY=1, MODE=1):	21
2.6.2 HV2070 Bank Switching Mode Operation (STBY=1, MODE=0):	21
2.7 Generation of Pulser Output at SW8T of HV2070	21
Chapter 3. GUI Description	
3.1 HV2070 Analog Switch Evaluation Board GUI Description	23
Chapter 4. PCB Design and Layout Notes	
4.1 PCB Layout Techniques for HV2070	25
4.1.1 High-Voltage and High-Speed Grounding and Layout Techniques	25
4.1.2 Decoupling Capacitors Selection	25

HV2070 Analog Switch Evaluation Board User's Guide

Appendix A. Schematic and Layouts

A.1 Introduction	27
A.2 ADM00853 - Schematic	28
A.3 ADM00853 - Top Silk	29
A.4 ADM00853 - Top Copper and Silk	29
A.5 ADM00853 - Top Copper	30
A.6 ADM00853 - Inner 1	30
A.7 ADM00853 - Inner 2	31
A.8 ADM00853 - Inner 3	31
A.9 ADM00853 - Bottom Copper	32
A.10 ADM00853 - Bottom Copper and Silk	32
A.11 ADM00853 - Bottom Silk	33
A.12 ADM00825 - Schematic (Connection)	34
A.13 ADM00825 - Schematic (Power Supply)	35
A.14 ADM00825 - Schematic (USB to SPI)	36
A.15 ADM00825 - Schematic (Programmable Clock)	37
A.16 ADM00825 - Schematic (FPGA)	38
A.17 ADM00825 - Schematic (FPGA Decoupling Capacitors)	39
A.18 ADM00825 - Schematic (Connectors)	40
A.19 ADM00825 - Top Silk	41
A.20 ADM00825 - Top Copper and Silk	41
A.21 ADM00825 - Top Copper	42
A.22 ADM00825 - Inner 1	42
A.23 ADM00825 - Inner 2	43
A.24 ADM00825 - Inner 3	43
A.25 ADM00825 - Inner 4	44
A.26 ADM00825 - Bottom Copper	44
A.27 ADM00825 - Bottom Copper and Silk	45
A.28 ADM00825 - Bottom Silk	45

Appendix B. Bill of Materials (BOM)

B.1 HV2070 Analog Switch Evaluation Board (ADM00853)	47
B.2 HV MUX Controller Board (ADM00825)	48

Appendix C. Demo Board Waveforms

C.1 Board Typical Waveforms	53
-----------------------------------	----

Worldwide Sales and Service	54
--	-----------

Preface

NOTICE TO CUSTOMERS

All documentation becomes dated, and this manual is no exception. Microchip tools and documentation are constantly evolving to meet customer needs, so some actual dialogs and/or tool descriptions may differ from those in this document. Please refer to our website (www.microchip.com) to obtain the latest documentation available.

Documents are identified with a “DS” number. This number is located on the bottom of each page, in front of the page number. The numbering convention for the DS number is “DSXXXXXXXXA”, where “XXXXXXXX” is the document number and “A” is the revision level of the document.

For the most up-to-date information on development tools, see the MPLAB® IDE online help. Select the Help menu, and then Topics, to open a list of available online help files.

INTRODUCTION

This chapter contains general information that will be useful to know before using the HV2070 Analog Switch Evaluation Board. Items discussed in this chapter include:

- [Document Layout](#)
- [Conventions Used in this Guide](#)
- [Recommended Reading](#)
- [The Microchip Web Site](#)
- [Customer Support](#)
- [Document Revision History](#)

DOCUMENT LAYOUT

This document describes how to use the HV2070 Analog Switch Evaluation Board as a development tool to emulate and debug firmware on a target board. The manual layout is as follows:

- **Chapter 1. “Product Overview”** – Important information about the HV2070 Analog Switch Evaluation Board.
- **Chapter 2. “Installation and Operation”** – This chapter includes a detailed description of each function of the demonstration board and instructions for how to begin using the HV2070 Analog Switch Evaluation Board.
- **Chapter 3. “GUI Description”** – This chapter describes the features of the GUI PC software.
- **Chapter 4. “PCB Design and Layout Notes”** – This chapter explains important points of the PCB design and layout of HV2070 Analog Switch Evaluation Board.
- **Appendix A. “Schematic and Layouts”** – Shows the schematic and PCB layout diagrams for the HV2070 Analog Switch Evaluation Board.
- **Appendix B. “Bill of Materials (BOM)”** – Lists the parts used to build the HV2070 Analog Switch Evaluation Board.
- **Appendix C. “Demo Board Waveforms”** – Describes the various demo waveforms for the HV2070 Analog Switch Evaluation Board.

HV2070 Analog Switch Evaluation Board User's Guide

CONVENTIONS USED IN THIS GUIDE

This manual uses the following documentation conventions:

DOCUMENTATION CONVENTIONS

Description	Represents	Examples
Arial font:		
Italic characters	Referenced books	<i>MPLAB® IDE User's Guide</i>
	Emphasized text	...is the <i>only</i> compiler...
Initial caps	A window	the Output window
	A dialog	the Settings dialog
	A menu selection	select Enable Programmer
Quotes	A field name in a window or dialog	"Save project before build"
Underlined, italic text with right angle bracket	A menu path	<u><i>File</i></u> >Save
Bold characters	A dialog button	Click OK
	A tab	Click the Power tab
N'Rnnnn	A number in verilog format, where N is the total number of digits, R is the radix and n is a digit.	4'b0010, 2'hF1
Text in angle brackets < >	A key on the keyboard	Press <Enter>, <F1>
Courier New font:		
Plain Courier New	Sample source code	#define START
	Filenames	autoexec.bat
	File paths	c:\mcc18\h
	Keywords	_asm, _endasm, static
	Command-line options	-Opa+, -Opa-
	Bit values	0, 1
	Constants	0xFF, 'A'
Italic Courier New	A variable argument	<i>file.o</i> , where <i>file</i> can be any valid filename
Square brackets []	Optional arguments	mcc18 [options] <i>file</i> [options]
Curly brackets and pipe character: { }	Choice of mutually exclusive arguments; an OR selection	errorlevel {0 1}
Ellipses...	Replaces repeated text	var_name [, var_name...]
	Represents code supplied by user	void main (void) { ... }

RECOMMENDED READING

This user's guide describes how to use the HV2070 Analog Switch Evaluation Board. Another useful document is listed below. The following Microchip document is available and recommended as a supplemental reference resource:

HV2070 Data Sheet – “No High-Voltage Bias, 32-Channel, High-Voltage Analog Switch with L-Switch Architecture” (DS20005923A)

THE MICROCHIP WEB SITE

Microchip provides online support via our web site at www.microchip.com. This web site is used as a means to make files and information easily available to customers. Accessible by using your favorite Internet browser, the web site contains the following information:

- **Product Support** – Data sheets and errata, application notes and sample programs, design resources, user's guides and hardware support documents, latest software releases and archived software
- **General Technical Support** – Frequently Asked Questions (FAQs), technical support requests, online discussion groups, Microchip consultant program member listing
- **Business of Microchip** – Product selector and ordering guides, latest Microchip press releases, listing of seminars and events, listings of Microchip sales offices, distributors and factory representatives

PRODUCT CHANGE NOTIFICATION SERVICE

Microchip's customer notification service helps keep customers current on Microchip products. Subscribers will receive e-mail notifications whenever there are changes, updates, revisions or errata related to a specified product family or development tool of interest.

To register, access the Microchip web site at www.microchip.com, click on **Product Change Notification** and follow the registration instructions.

CUSTOMER SUPPORT

Users of Microchip products can receive assistance through several channels:

- Distributor or Representative
- Local Sales Office
- Field Application Engineer (FAE)
- Technical Support

Customers should contact their distributor, representative or field application engineer (FAE) for support. Local sales offices are also available to help customers. A listing of sales offices and locations is included in the back of this document.

Technical support is available through the web site at:
<http://www.microchip.com/support>.

DOCUMENT REVISION HISTORY

Revision A (December 2017)

- Initial Release of this Document.

HV2070 Analog Switch Evaluation Board User's Guide

NOTES:

Chapter 1. Product Overview

1.1 INTRODUCTION

The HV2070 Analog Switch Evaluation Board (ADM00853) works with the HV MUX Controller Board (ADM00825) to provide No High-Voltage Bias, 32-Channel, High-Voltage Analog Switches, with L-Switch Architecture, demonstration including basic switch ON/OFF operation, and 2:1 MUX operation with two built-in MD1822 and TC6320 pulser circuits.

1.2 HV2070 DEVICE SHORT OVERVIEW

The HV2070 device is a No High-Voltage Bias, 32-Channel, High-Voltage Analog Switches, with L-Switch Architecture. It is designed to be used in applications requiring high-voltage switching, controlled by low-voltage command signals, such as medical ultrasound imaging, driving piezoelectric transducers and in printers. Using the patented L-Switch architecture, the typical 4.5Ω on-resistance analog switch can pass the analog pulse signal up to $\pm 3.7A$ of current, at $\pm 100V$, without high-voltage supplies, such as $\pm 100V$. It requires only $\pm 6V$ or $\pm 5V$ for the ON/OFF switch operation and $3.3V$ for the logic operation.

The HV2070 device has two modes of operation: individual switching mode and bank switching mode. The user can select the mode through the MODE pin logic input. The 32 analog switches can be controlled individually through digital interface when the MODE input is high (Individual switching mode). The digital interface clock operates up to 66 MHz. All 16 even switches and all 16 odd switches can be controlled together through simple 2 logic inputs, when the MODE input is low (bank switching mode).

HV2070 has a standby mode, in order to decrease power consumption at idle state. When \overline{STBY} logic input is low, the device operates in standby mode and consumes very low current. When \overline{STBY} logic input is high, the device operates normally.

1.3 HV2070 ANALOG SWITCH EVALUATION BOARD FEATURES

- HV2070 No High-Voltage Bias, 32-Channel, High-Voltage Analog Switches, with L-Switch Architecture
- Designed to work with Microchip HV MUX Controller Board
- Two 2:1 MUX with built-in MD1822 and TC6320 pulsers
- 5 MHz 3-level voltage pulse waveform outputs
- On-board 330 pF//2.5 k Ω dummy load per SW8T, SW9T, SW24T, SW25T
- Mode selection and ON/OFF switch, controlled through the PC GUI and the HV MUX Controller Board
- Pulser ON/OFF and time domain, controlled through the PC GUI and the HV MUX Controller Board

HV2070 Analog Switch Evaluation Board User's Guide

1.4 WHAT IS THE HV2070 ANALOG SWITCH EVALUATION BOARD?

The HV2070 Analog Switch Evaluation Board can control the HV2070 device's operation and built-in pulsers that are connected to the two 2:1 MUX switches for demonstration. Four switch outputs, two of which are 2:1 MUX, have SMA connectors and the user can connect four transducer elements. The other side of the 2:1 MUX is connected to two built-in MD1822 and TC6320 pulsers. The HV2070 Analog Switch Evaluation Board can drive four transducer elements with 5 MHz \pm 100V pulse signals.

The HV2070 Analog Switch Evaluation Board features one HV2070/AJA 10x10x1.1 mm 121-Lead TFBGA packaged integrated circuit, two MD1822K6-G 3x3x1 mm 16-Lead QFN packaged integrated circuits and four TC6320K6-G 4x4x1 mm 8-Lead DFN packaged NMOS and PMOS pair integrated circuits.

The HV2070 Analog Switch Evaluation Board uses two high-speed 20-signal pair carrying capable right-angle backplane connectors, which are designed to work with the Microchip HV MUX Controller Board (ADM00825) as a control signal source.

The HV MUX Controller Board has an FPGA that generates pulser waveform and logic control signals and a USB-bridge IC that connects the control board to a PC. By using a Microsoft® Windows® operated PC and the GUI software, the user can control the HV2070 device and two built-in pulsers.

Four switch terminals, consisting of two MUX configurations on the PCB, have SMA connectors to which the user can connect loads. The jumpers close to the SMA connectors are for connecting the on-board dummy R-C load (330 pF//2.5 K Ω) optionally to the pulser output.

WARNING

Risk warning of electrical shock. This board uses **multiple hazardous high voltages**. Disconnect all high voltage supplies before working on it. **Electrical safety precautions** must be taken when working on or using this board.

1.5 HV2070 ANALOG SWITCH EVALUATION BOARD TECHNICAL PARAMETERS

TABLE 1-1: HV2070 ANALOG SWITCH EVALUATION BOARD TECHNICAL PARAMETERS

Parameter	Value
HV2070 Modes of Operation	Individual Switching, Bank Switching and Standby modes
Pulser frequency	5 MHz
Number of pulses in the train	1 to 90
T _{OFF} time between pulse trains	5 to 30 msec
Pulse Peak Voltage & Current	0 to \pm 100V and \pm 3.7A (typical)
Interface of FPGA Control Signals & USB PC-GUI Software	J1 and J2 Connects to ADM00825 Controller Interface Board
Pulser R-C Test-Load & User's Transducer Interface	Built-in, 330 pF//2.5 K Ω per Channel with jumper and 50 Ω SMA
PCB Board Dimension	115 mm x 110 mm

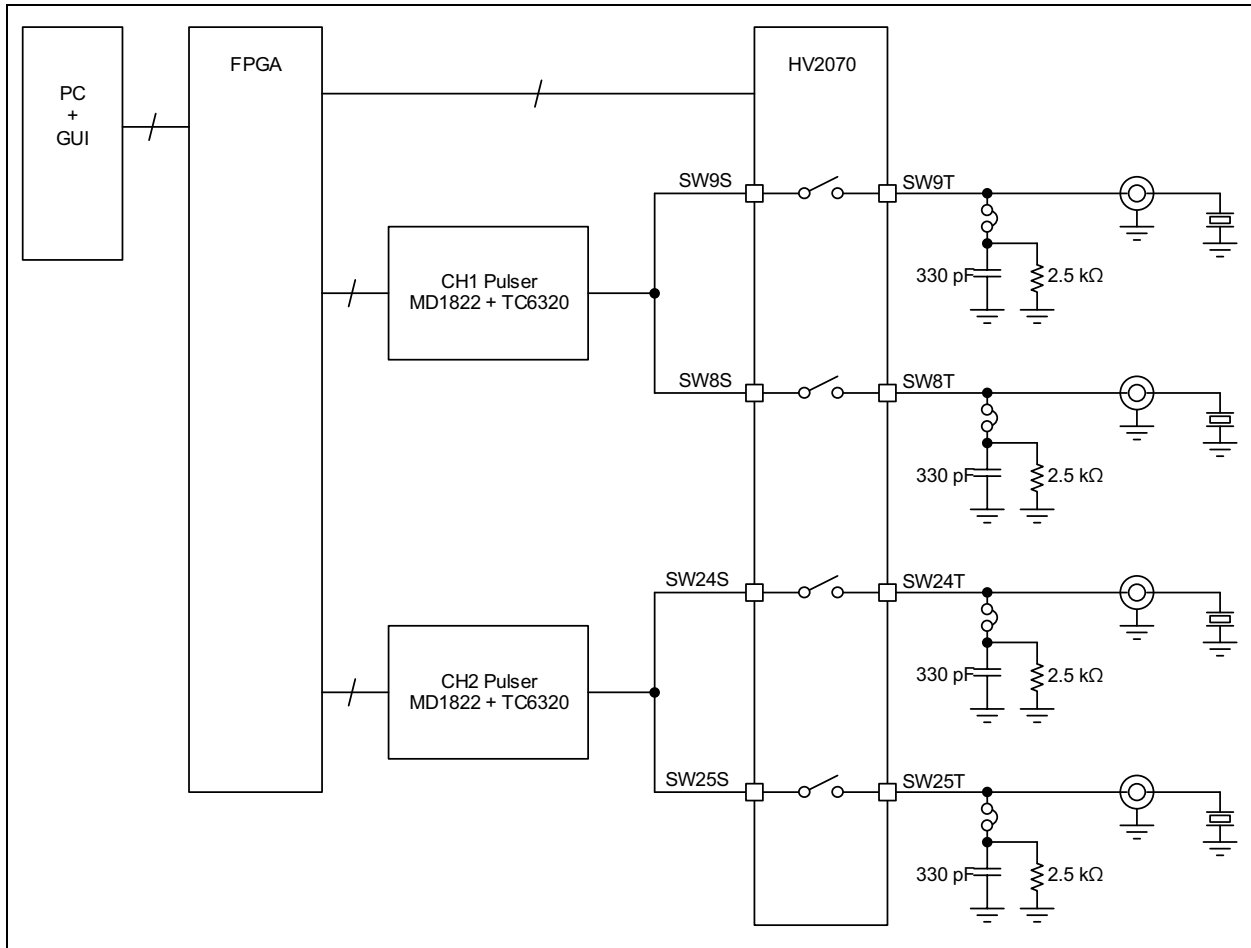

FIGURE 1-1: HV2070 Analog Switch Evaluation Board Simplified Block Diagram.

1.6 HV2070 ANALOG SWITCH EVALUATION BOARD KIT CONTENTS

The HV2070 Analog Switch Evaluation Board includes:

- HV2070 Analog Switch Evaluation Board (ADM00853)
- Important Information Sheet

HV2070 Analog Switch Evaluation Board User's Guide

NOTES:

Chapter 2. Installation and Operation

2.1 GETTING STARTED

The HV2070 Analog Switch Evaluation Board is fully assembled and tested. The board requires six power supply voltage rails of +3.3V, +10V, $\pm 6.0V$ and $\pm 100V$.

2.1.1 Additional Tools Required for Operation

1. An oscilloscope with minimum 500 MHz bandwidth and two high-impedance probes. Make sure the grounds of the power supply sources are correctly connected to the same ground as the testing oscilloscope ground;
2. A Microchip HV MUX Controller Board (ADM00825);
3. A Microsoft® Windows® 7 PC, with the HV MUX Controller Board GUI software installed and running;
 - connect J1 and J2 to the HV MUX Controller Board
 - connect the HV MUX Controller Board through the USB port to the Windows 7 PC

2.2 HV MUX GUI INSTALLATION

The HV MUX GUI software installer can be downloaded from the Microchip web site at www.microchip.com. Search for the evaluation board on the web site by the part number ADM00853.

1. Open the `HVMUXGUI-v1.0.0-windows-installer.exe`.
2. Initiate the HV MUX GUI software installer by launching the Application Install dialog box.
3. Click **Next** to start the installation.

HV2070 Analog Switch Evaluation Board User's Guide

FIGURE 2-1: HV MUX GUI - APPLICATION INSTALL DIALOG BOX



4. Read the License Agreement and accept it by checking the box corresponding to "I accept the agreement". Click **Next** to proceed with the installation.

FIGURE 2-2: HV MUX GUI - LICENSE AGREEMENT DIALOG BOX

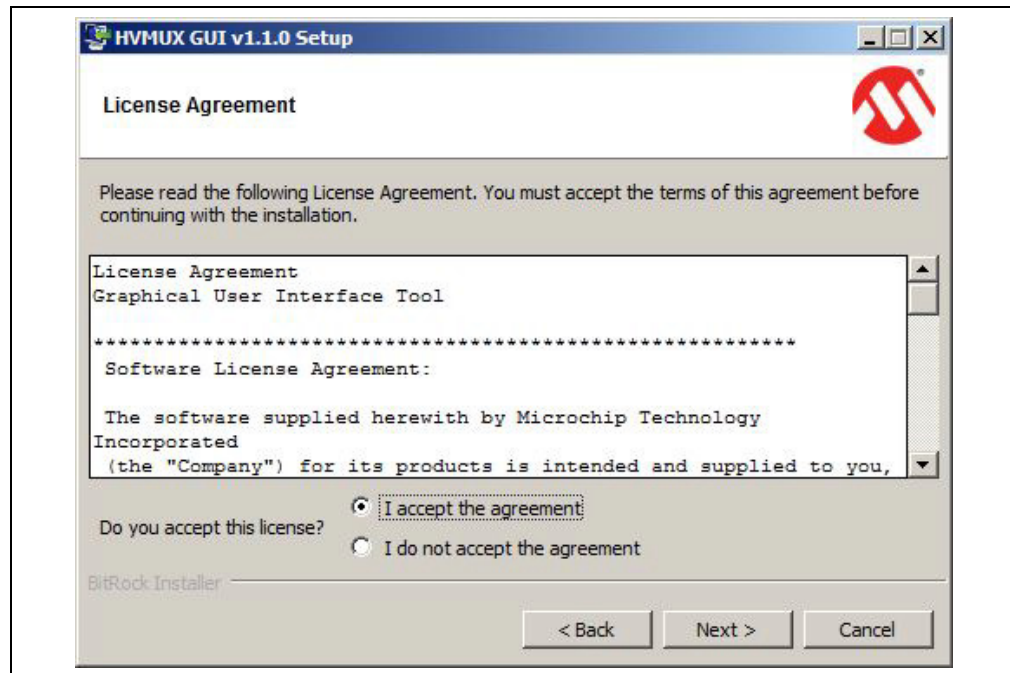

5. On the Installation Directory dialog box, browse for the desired location or click **Next** to install in the default location.

FIGURE 2-3: HV MUX GUI - INSTALLATION DIRECTORY DIALOG BOX

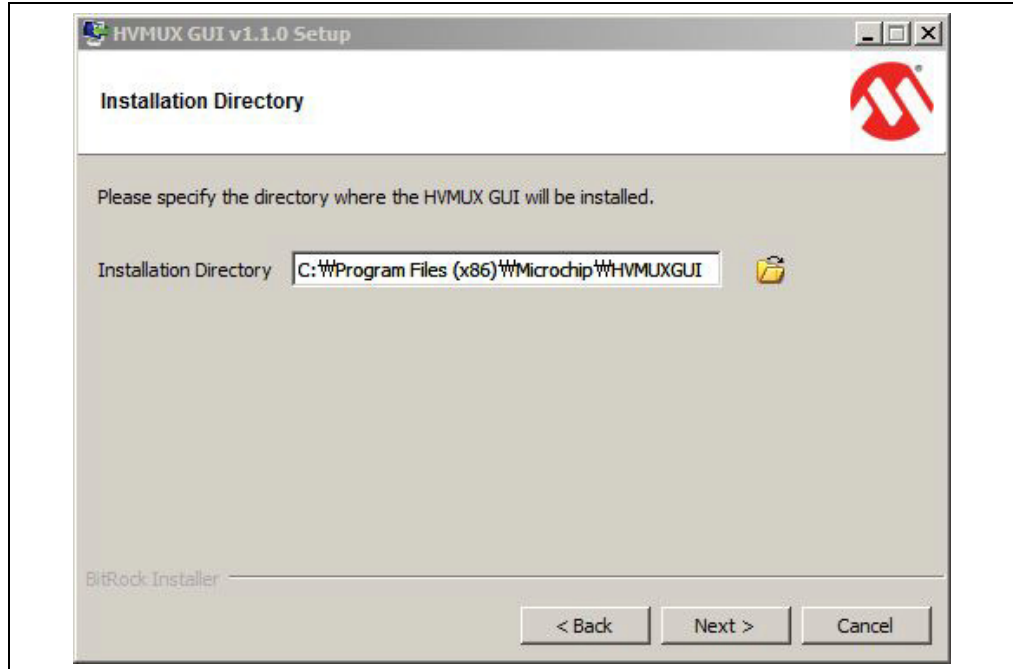

6. Once the installation path is chosen, the software is ready to install. Click **Next**.

FIGURE 2-4: HV MUX GUI - READY TO INSTALL DIALOG BOX

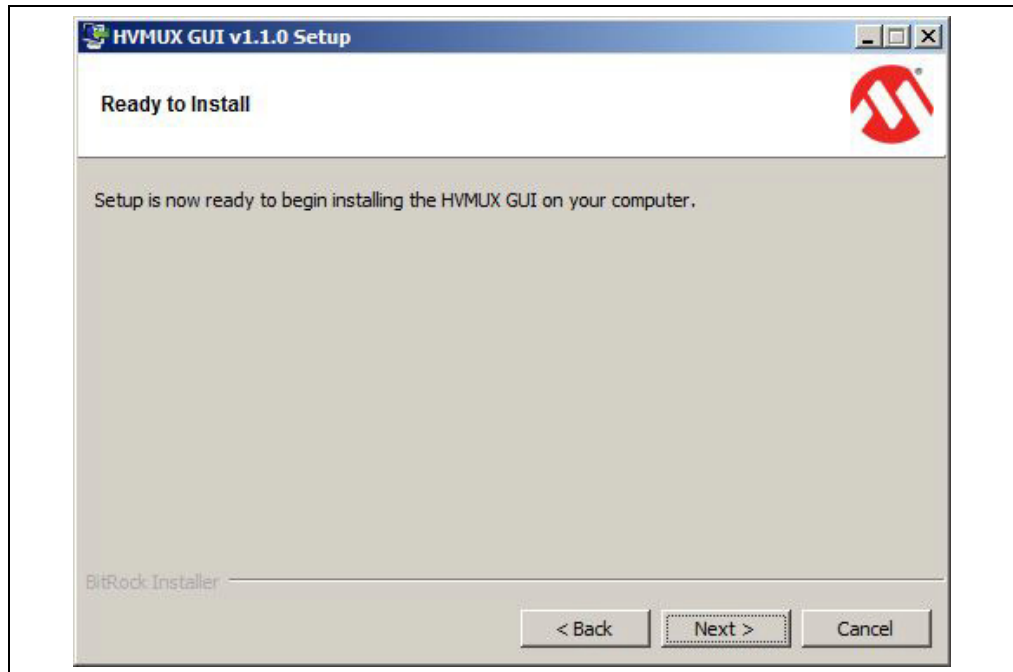

7. The installation status window appears, showing the installation progress.

8. After the installation has completed, click **Next**.

HV2070 Analog Switch Evaluation Board User's Guide

FIGURE 2-5: HV MUX GUI - INSTALLATION STATUS DIALOG BOX

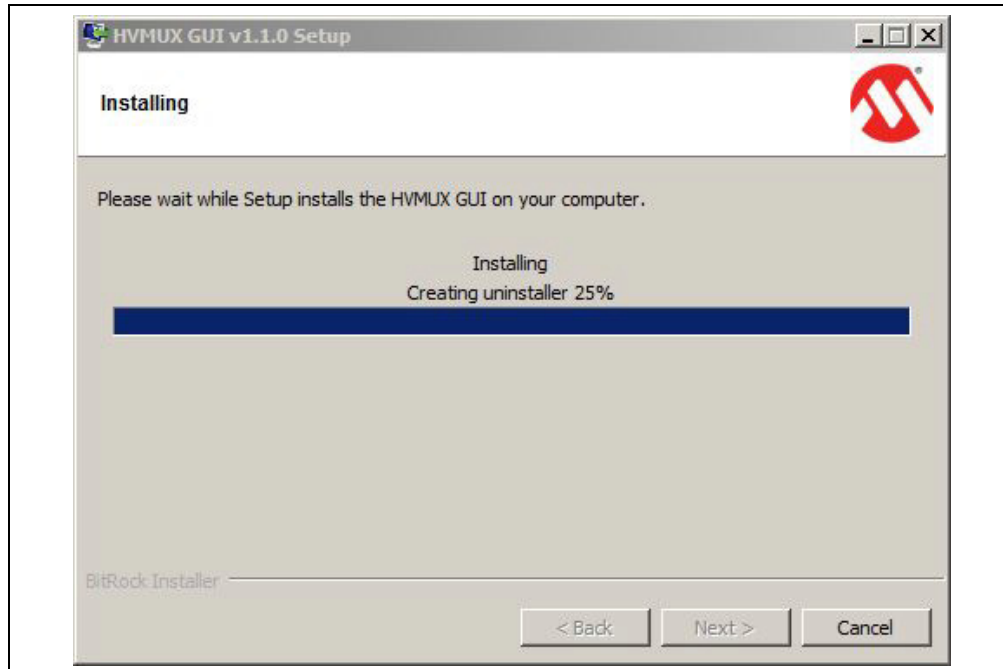

9. Once Installation Complete dialog box appears, click the **Finish** button to exit the installer.

FIGURE 2-6: HV MUX GUI - INSTALLATION COMPLETE DIALOG BOX



2.3 HV2070 ANALOG SWITCH EVALUATION BOARD SETUP PROCEDURE

To operate the HV2070 Analog Switch Evaluation Board, the following steps must be completed:

1. Attach it to the HV MUX Controller Board (ADM00825) with connector J1 and J2.
2. Connect all the jumpers on J5, J6, J7 and J11 for the on-board R-C load.
3. Connect all the power supplies to the voltage supply input connectors J3 and J4, as indicated in [Table 2-1](#) by observing the polarity.

WARNING

Please observe the polarity of each power supply rail and set the voltage and current limit carefully.

4. Turn on the V_{SS} first and then turn on the V_{DD} .
5. Turn on the V_{LL} .
6. Turn on the V_{GP} and V_{PP}/V_{NN} .
7. Connect a USB cable from the HV MUX Controller Board to the PC.
8. Connect +12V/1A power to the HV MUX Controller Board.
9. Run the HV MUX GUI software on the PC.
10. Click the **Initialize HV MUX Controller Board** button in the GUI. This causes the status window at the bottom of the screen to display an “initialization complete” message.
11. Clear the **STBY** check box to set HV2070 in normal operation and choose the switching mode by selecting/clearing the **MODE** check box.
12. Click the **Set HV MUX** button. All digital control signals are applied to HV2070.
13. Set the number of pulses and T_{OFF} time of the pulser.
14. Select CH1 or CH2 to set the channel 1 pulser or the channel 2 pulser, respectively.
15. Click the **Start** button for the selected pulser to generate pulse trains.
16. Click the **Stop** button for the selected pulser to stop generating pulse trains.

TABLE 2-1: POWER SUPPLY VOLTAGES AND CURRENT-LIMIT SETTINGS

Terminal	Rail Name	Voltage	Average-Current Limit
J3-1	V_{DD}	+5V or +6V	+20 mA
J3-2	GND	0V	—
J3-3	V_{SS}	-5V or -6V	-20 mA
J4-1	V_{LL}	+3.3V	+150 mA
J4-2	GND	0V	—
J4-3	V_{GP}	+5 to +11.5V	+10 mA
J4-4	V_{PP}	+100V	+5 mA
J11-2	V_{NN}	-100V	-5 mA

HV2070 Analog Switch Evaluation Board User's Guide

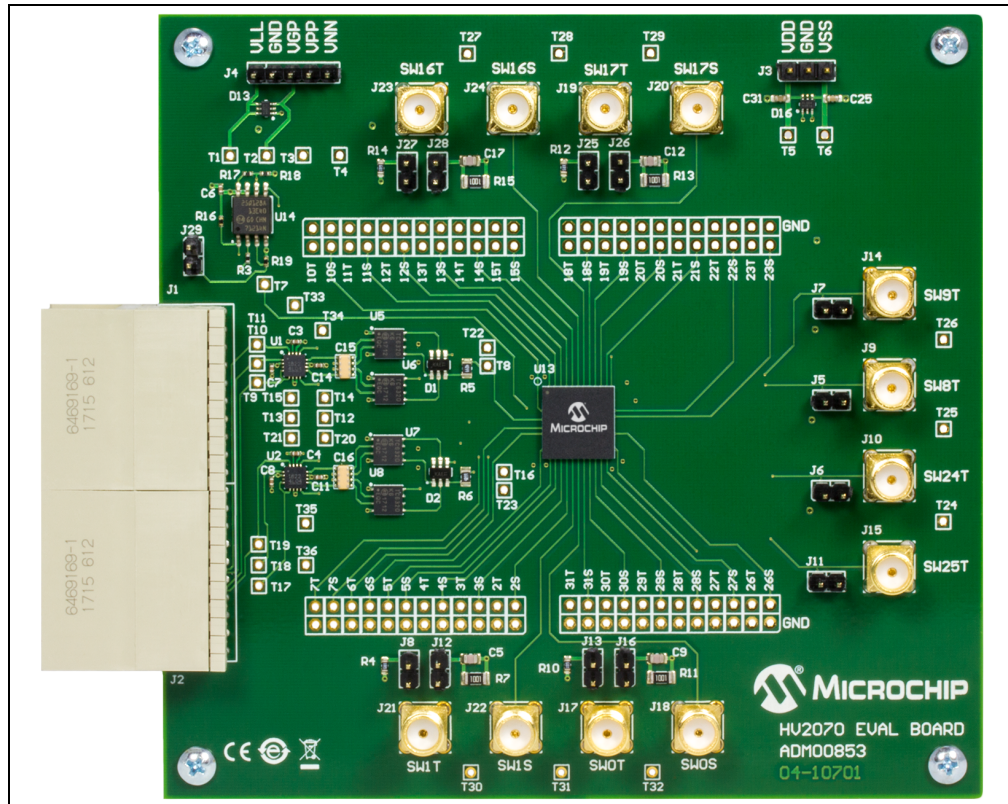

FIGURE 2-7: HV2070 Analog Switch Evaluation Board - Front View.

2.3.1 Recommended Power-Up and Power-Down Sequences

Table 2-2 shows the recommended power-up and power-down sequences of the HV2070 Analog Switch Evaluation Board.

TABLE 2-2: HV2070 ANALOG SWITCH EVALUATION BOARD POWER-UP AND POWER-DOWN SEQUENCES

Step	Power-Up Description	Step	Power-Down Description
1	V _{SS} on	1	V _{PP} and V _{NN} off
2	V _{DD} on	2	V _{GP} off
3	V _{LL} on with logic signal low	3	V _{LL} off with logic signal low
4	V _{GP} on	4	V _{DD} off
5	V _{PP} and V _{NN} on	5	V _{SS} off

WARNING

Powering the HV2070 Analog Switch Evaluation Board up/down in an arbitrary sequence may cause damage to the device.

2.4 INTERFACE CONNECTIONS

TABLE 2-3: J2 CONTROL INTERFACE SIGNALS

PIN #	Name	Test Point	I/O Type	Signal Discretion
J2-A2	SCK	—	LVC MOS-2.5V Input	EEPROM Serial Clock Input
J2-B2	CSB	—	LVC MOS-2.5V Input	EEPROM Chip Select Input
J2-A3	MISO	—	LVC MOS-2.5V Output	EEPROM Serial Data Output
J2-B3	MOSI	—	LVC MOS-2.5V Input	EEPROM Serial Data input
J2-A5	CLR	TP15	LVC MOS-3.3V Input	HV2070 Latch Clear Logic Input
J2-B5	CLK	TP14	LVC MOS-3.3V Input	HV2070 Clock Logic Input
J2-C5	$\overline{\text{LE}}/\text{EN}$	TP12	LVC MOS-3.3V Input	HV2070 Latch Enable Logic Input
J2-D5	MODE	TP13	LVC MOS-3.3V Input	HV2070 Mode Logic Input
J2-A6	DIN/AB	TP20	LVC MOS-3.3V Input	HV2070 Data In Logic Input
J2-B6	$\overline{\text{STBY}}$	TP21	LVC MOS-3.3V Input	HV2070 Standby Logic Input, Low active
J2-C6	1_A	TP11	LVC MOS-3.3V Input	Ch1 Pulser input for NMOS to V_{NN}
J2-D6	1_B	TP10	LVC MOS-3.3V Input	Ch1 Pulser input for PMOS to V_{PP}
J2-A7	1_DMP	TP9	LVC MOS-3.3V Input	Ch1 Pulser Damp Input for PMOS/NMOS to GND
J2-B7	2_A	TP19	LVC MOS-3.3V Input	Ch2 Pulser input for NMOS to V_{NN}
J2-C7	2_B	TP18	LVC MOS-3.3V Input	Ch2 Pulser input for PMOS to V_{PP}
J2-D7	2_DMP	TP17	LVC MOS-3.3V Input	Ch2 Pulser Damp Input for PMOS/NMOS to GND

Note 1: All the pins that are not included in this table are no-connect.

HV2070 Analog Switch Evaluation Board User's Guide

2.5 HV MUX CONTROLLER BOARD SETUP PROCEDURE

The HV MUX Controller Board generates control signals for HV2070 Analog Switch Evaluation Board and features a Spartan-6 XC6SLX9 FPGA.

1. Before powering up the HV2070 Analog Switch Evaluation Board and the HV MUX Controller Board, make sure that the latest GUI software is installed on the PC.
2. Start the GUI program. If the board is not connected, a “Not Connected” message is displayed in the Status bar, located at the bottom left of the screen.
3. Connect the appropriate power supply and turn on the power switch to power-up the HV MUX Controller Board. The FPGA_OK(LD1) and DC_IN (LD2) on the HV MUX Controller Board should light up green. A “Connected” message is displayed on the bottom left of the Status bar of the GUI.

The HV MUX Controller Board is now ready to control the HV2070 Analog Switch Evaluation Board.

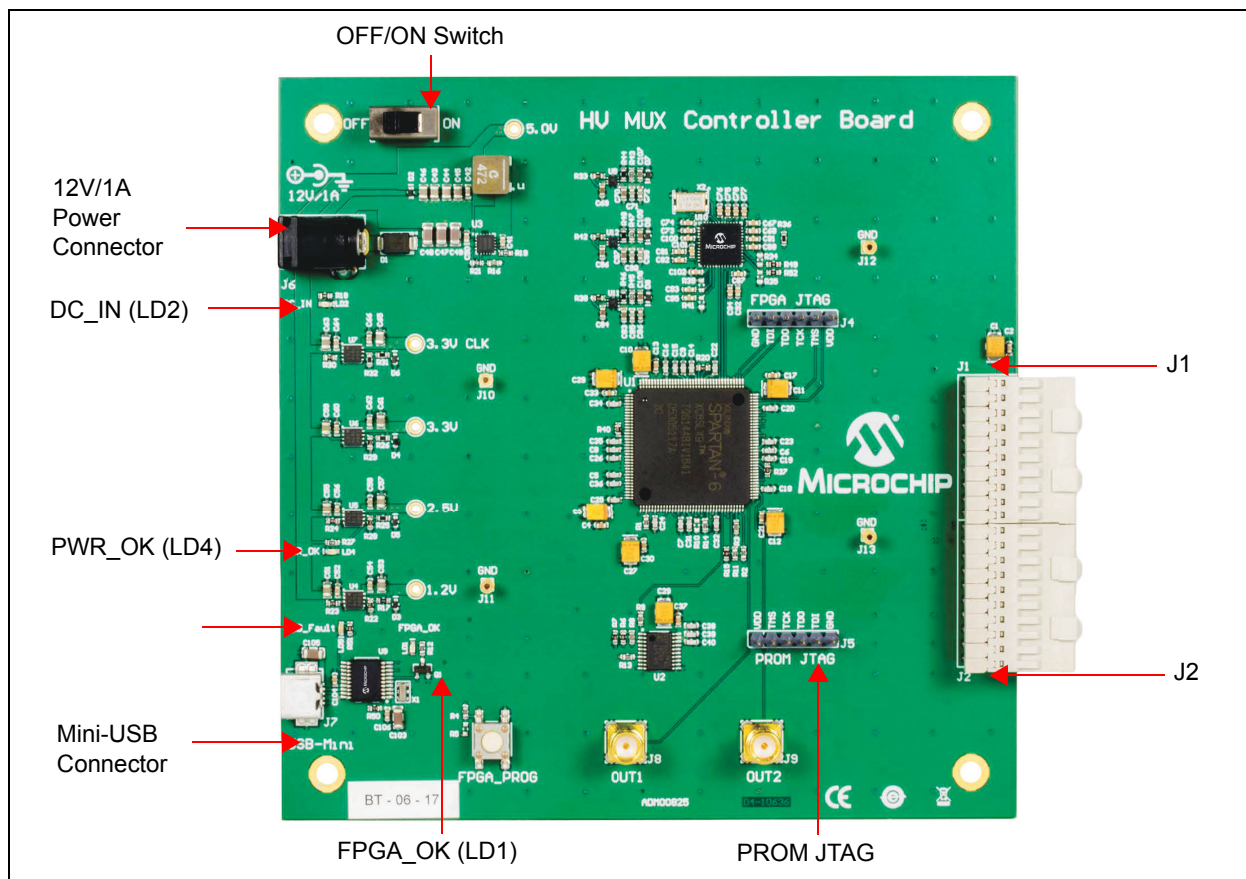

FIGURE 2-8: HV MUX Controller Board (ADM00825) - Front View.

2.6 TESTING THE HV2070 ANALOG SWITCH EVALUATION BOARD

2.6.1 HV2070 Individual Switching Mode Operation (STBY=1, MODE=1):

In the individual switching mode, the user can turn on/off each of the 32 switches through the USB connected PC GUI software program:

1. Click the **Initialize HV MUX Controller** button located at the top left corner.
2. Clear $\overline{\text{STBY}}$ to set HV2070 in normal operation.
3. Select MODE to set HV2070 in individual switching mode.
4. Put 32 bit data in DIN to set switches ON and OFF. Data 1 means the switch is ON and data 0 means the switch is OFF.
5. Click the **Set HV MUX** button.
6. Then, the GUI and controller board generate 32-bit data and 32 clocks followed by one $\overline{\text{LE}}$ negative pulse, and switches are ON and OFF according to DIN in the GUI.
7. If the user selects CLR and then clicks the **Set HV MUX** button, all the switches are OFF.

2.6.2 HV2070 Bank Switching Mode Operation (STBY=1, MODE=0):

In the bank switching mode, the user can turn on/off all the even switches (SW0, SW2,..., SW30) together and all the odd switches (SW1, SW3,..., SW31) together through the USB connected PC GUI software program:

1. Click the **Initialize HV MUX Controller** button at the top left corner.
2. Clear $\overline{\text{STBY}}$ to set HV2070 in normal operation.
3. Clear MODE to set HV2070 in bank switching mode.
4. Select the EN check box to set HV2070 bank switching to active. If EN is not selected, all the switches are set to OFF.
5. Select $\overline{\text{A/B}}$ to set all the even switches ON and all the odd switches OFF.
6. **Or**, clear $\overline{\text{A/B}}$ to set all the even switches OFF and all the odd switches ON.
7. Click the **Set HV MUX** button.
8. The GUI and the HV MUX Controller Board generate digital control signals according to the control data of the GUI that the user sets.

Note: The typical voltage and waveforms are provided in [Appendix C. "Demo Board Waveforms"](#).

2.7 GENERATION OF PULSER OUTPUT AT SW8T OF HV2070

This section provides the simple step-by-step procedure to make the Ch1 pulser output at SW8T SMA connector by configuring the GUI.

1. Before powering up the HV2070 Analog Switch Evaluation Board, make sure that the latest GUI software is installed on the PC.
2. Start the GUI program. If the board is not connected, a "Not Connected" message is displayed in the Status bar, located at the bottom left of the screen.
3. Power up the HV MUX Controller Board and HV2070 Analog Switch Evaluation Board as described in the previous section. The prompt "Connected" is displayed in the Status bar.
4. Click the **Initialize HV MUX Controller** button and check the message window

HV2070 Analog Switch Evaluation Board User's Guide

to see "Initialization Complete".

5. Clear the $\overline{\text{STBY}}$ check box to set the HV2070 device to operate normally.
6. Select MODE to set the HV2070 device to individual switching mode.
7. Change the DIN to Bit 8 from 0 to 1 to set SW8 ON (DIN = 00000000 00000000 00000001 00000000).
8. Click the **Set HV MUX** button to turn on the HV2070 SW8.
9. Change the Pluses to 10.
10. Select CH1.
11. Click the **Start** button so that the CH1 pulser starts to generate pulse trains with 10 pulses and 30 ms T_{OFF} time.

The Ch1 and Ch2 of the oscilloscope in [Figure 2-9](#) show the SW8T and the SW9T.

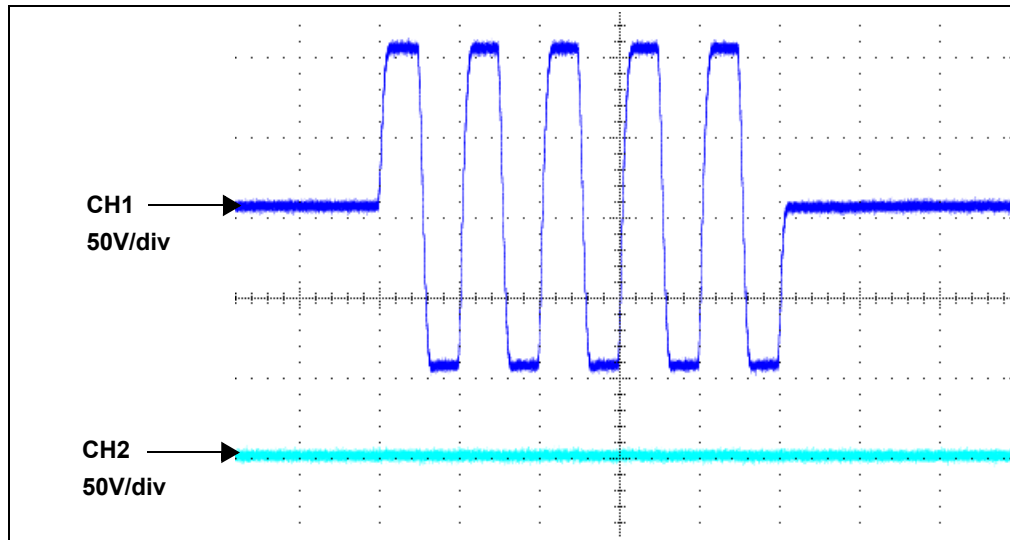

FIGURE 2-9: Typical Waveform of 2:1 MUX Connected to Pulser.

Chapter 3. GUI Description

3.1 HV2070 ANALOG SWITCH EVALUATION BOARD GUI DESCRIPTION

Figure 3-1 displays a screen capture of the HV MUX Controller Board GUI. Table 3-1 provides a detailed description of every item numbered in the screen capture. The selection of the check box, binary data in the DIN entry box and number in Pulses and TOFF entry box are just settings and don't change the operation of HV2070 and built-in pulsers immediately. By clicking the **Set HV MUX**, **Start** and **Stop** buttons, the control data set by the user in the GUI changes operation of HV2070 and turn on/off the built-in pulsers in the HV2070 Analog Switch Evaluation Board. Follow the explanation for each corresponding item.

FIGURE 3-1: HV MUX CONTROLLER BOARD GUI SCREEN CAPTURE

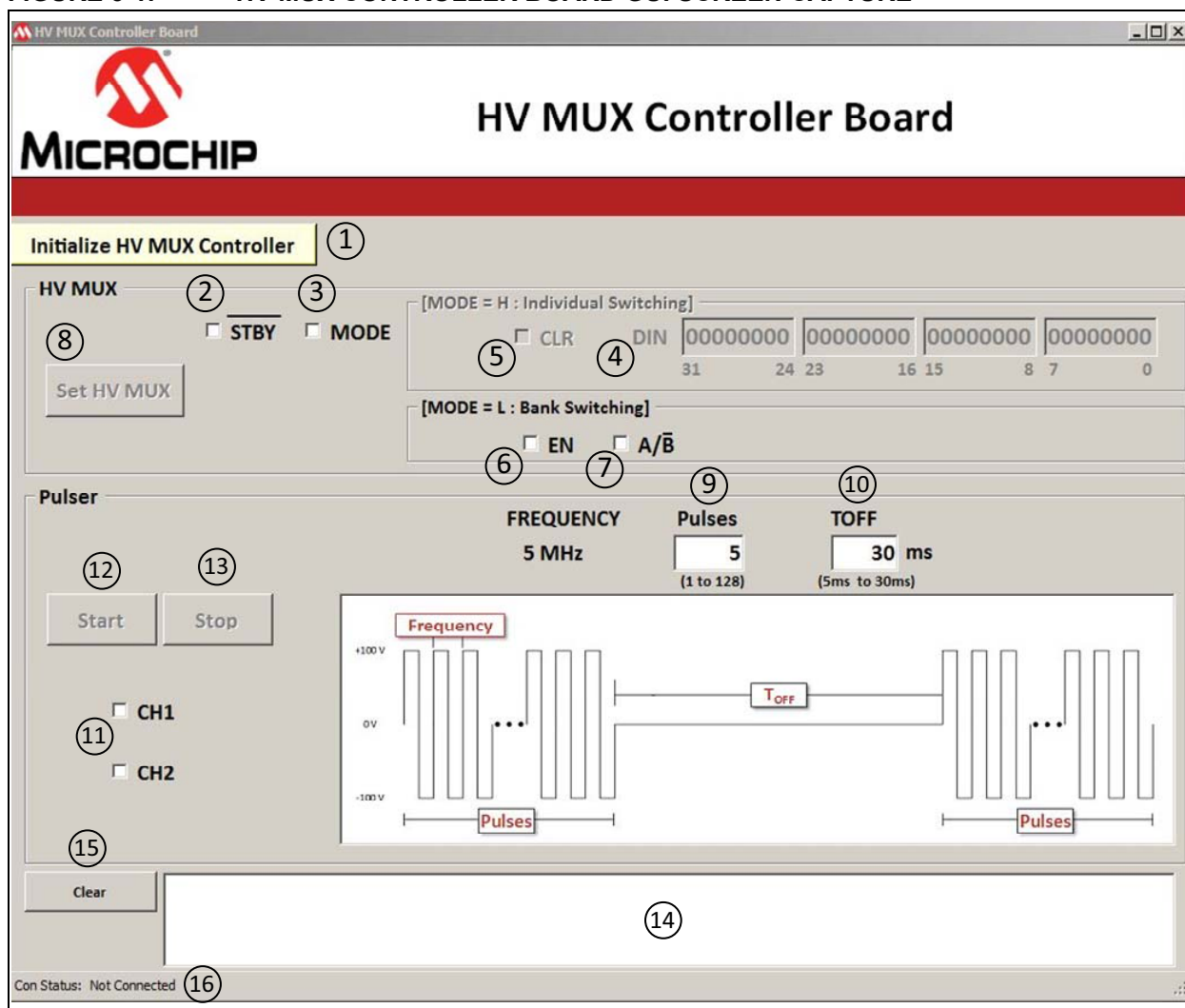

HV2070 Analog Switch Evaluation Board User's Guide

TABLE 3-1: HV2070 ANALOG SWITCH EVALUATION BOARD GUI DESCRIPTION

Item Number	Item Name	Item Description
1	Initialize HV MUX Controller	This button controls whether the GUI starts the initialization of FPGA on the HV MUX Controller Board and the communication between the GUI and the HV MUX Controller Board. If there is no error, the "Initialization Complete" message is displayed in the Message Window.
2	$\overline{\text{STBY}}$	When this check box is selected, the $\overline{\text{STBY}}$ logic input is set to low and HV2070 is set to operate in standby mode, in order to decrease power consumption. When cleared, the $\overline{\text{STBY}}$ logic input is set to high and HV2070 is set to operate in normal mode.
3	MODE	When this check box selected, the MODE logic input is set to high and HV2070 is set to operate in individual switching mode. When cleared, the MODE logic input is set to low and HV2070 is set to operate in bank switching mode.
4	DIN	32-bit data entry boxes. Each bit in the boxes is related to each analog switch. If data entry is 1, the associated switch is set to ON. If data entry is 0, the associated switch is set to OFF.
5	CLR	When this check box is selected, the CLR logic input is set to high and all the switches of HV2070 are set to OFF. When cleared, the CLR logic input is set to low and the 32 switches of HV2070 are set to ON/OFF states, according to the DIN data entry
6	EN	When this check box is selected, the EN logic input is set to high and HV2070 is activated for bank switching mode. When cleared, the EN logic input is set to low and all the switches are set to OFF.
7	A/\overline{B}	When this check box is selected, the A/\overline{B} logic input is set to high, all the even switches are set to ON and all the odd switches are set to OFF. When cleared, the A/\overline{B} logic input is set to low, all the even switches are set to OFF and all the odd switches are set to ON.
8	Set HV MUX	This button controls whether the data described in the items 2 to 7 is applied to HV2070. Note that the 32-bit DIN data, 32 clocks and one negative LE pulse are applied one time only at the individual switching mode.
9	Pulses	This text box defines the number of pulses in the pulse train generated by the selected pulser. A pulse is a half of the cycle and the pulse train always starts the positive pulse first.
10	TOFF	This text box defines the interval between pulse trains generated by the selected pulser.
11	CH1/CH2	When one of these check boxes is selected, the respective pulser is set to generate 5 MHz pulse trains defined at steps 9 and 10 by the user.
12	Start	This button controls if the selected pulser starts generating the pulse train.
13	Stop	This button controls if the selected pulser stops generating the pulse train.
14	Message Window	This window displays information from the GUI program.
15	Clear	This button clears the messages in the Message window.
16	Connection Status	This window displays status of the connection between the GUI and the HV MUX Controller Board.

Chapter 4. PCB Design and Layout Notes

4.1 PCB LAYOUT TECHNIQUES FOR HV2070

The HV2070 Analog Switch Evaluation Board is an analog switch to pass high-voltage, high-current and high-frequency pulses. The PCB design and layout are important to ensure the success of the implementation.

4.1.1 High-Voltage & High-Speed Grounding and Layout Techniques

The center balls at the bottom of the HV2070 TFBGA package are internally connected to the IC's substrate (V_{SUB}). These balls should be connected to GND, externally on the PCB.

The user must pay attention to the connecting traces, since the analog switches pass the high-voltage and high-speed signals. In particular, controlled impedance of 50Ω to the ground plane and more trace spacing needs to be applied in this situation.

High-speed PCB trace design practices are used for the HV2070 Analog Switch Evaluation Board PCB layout. The internal circuitry of the HV2070 can operate at quite a high frequency, with the primary speed limitation being the load capacitance. Because of this high speed and the high transient currents that result from driving capacitive loads, the supply voltage bypass capacitors should be as close to the pins as possible.

All the GND pins should have low inductance feed through connections that are connected directly to a solid ground plane at the second layer of the PCB.

It is recommended to minimize the trace length to the ground plane, and to insert a ferrite bead in the power supply lead to the capacitor to prevent resonance in the power supply lines.

It is important to minimize trace lengths and use sufficient trace width to reduce inductance. Surface mount components are highly recommended.

The use of a solid ground plane and good power and signal layout practices will prevent any possible parasitic capacitance coupling. The user should also ensure that the circulating ground return current from a capacitive load cannot react with common inductance to create noise voltages in the input logic circuitry.

4.1.2 Decoupling Capacitors Selection

The V_{LL} , V_{DD} and V_{SS} supply voltage rails are able to provide fast transient current. Therefore, they should have a low-impedance bypass capacitor close to each of the power supply pins. Use a surface-mounted ceramic capacitor of 1.0 to 2.2 μF capacitance with an appropriate voltage rating.

It is important to verify what type of ceramic capacitor is selected for these bypass capacitors. The low impedance means low ESR/ESL impedance within the frequency bandwidth range of ultrasound pulses transmitted, including the very fast dV/dt of the pulse's rising and falling edges. A capacitor with low-temperature coefficient and low-voltage coefficient is also recommended. The type of X7R and X5R or other more advanced multilayer-ceramic types should be selected for these purposes.

HV2070 Analog Switch Evaluation Board User's Guide

NOTES:

Appendix A. Schematic and Layouts

A.1 INTRODUCTION

This appendix contains the following schematics and layouts for the HV2070 Analog Switch Evaluation Board (ADM00853) and the HV MUX Controller Board (ADM00825)

- HV2070 Analog Switch Evaluation Board (ADM00853):
 - ADM00853 - Schematic
 - ADM00853 - Top Silk
 - ADM00853 - Top Copper and Silk
 - ADM00853 - Top Copper
 - ADM00853 - Inner 1
 - ADM00853 - Inner 2
 - ADM00853 - Inner 3
 - ADM00853 - Bottom Copper
 - ADM00853 - Bottom Copper and Silk
 - ADM00853 - Bottom Silk
- HV MUX Controller Board (ADM00825):
 - ADM00825 - Schematic (Connection)
 - ADM00825 - Schematic (Power Supply)
 - ADM00825 - Schematic (USB to SPI)
 - ADM00825 - Schematic (Programmable Clock)
 - ADM00825 - Schematic (FPGA)
 - ADM00825 - Schematic (FPGA Decoupling Capacitors)
 - ADM00825 - Schematic (Connectors)
 - ADM00825 - Top Silk
 - ADM00825 - Top Copper and Silk
 - ADM00825 - Top Copper
 - ADM00825 - Inner 1
 - ADM00825 - Inner 2
 - ADM00825 - Inner 3
 - ADM00825 - Inner 4
 - ADM00825 - Bottom Copper
 - ADM00825 - Bottom Copper and Silk
 - ADM00825 - Bottom Silk

A.2 ADM00853 - SCHEMATIC

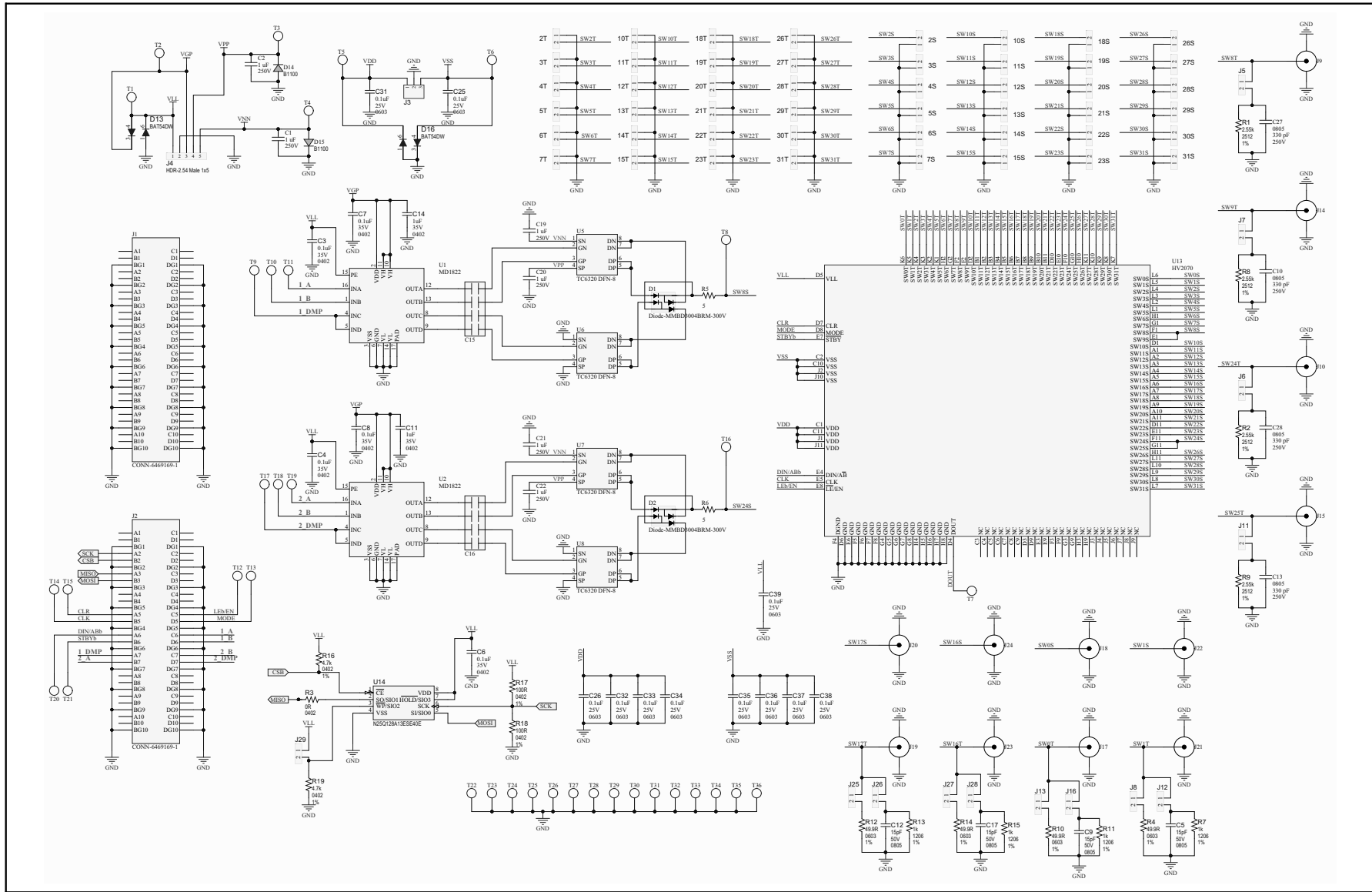

HV2070 Analog Switch Evaluation Board User's Guide

A.5 ADM00853 - TOP COPPER

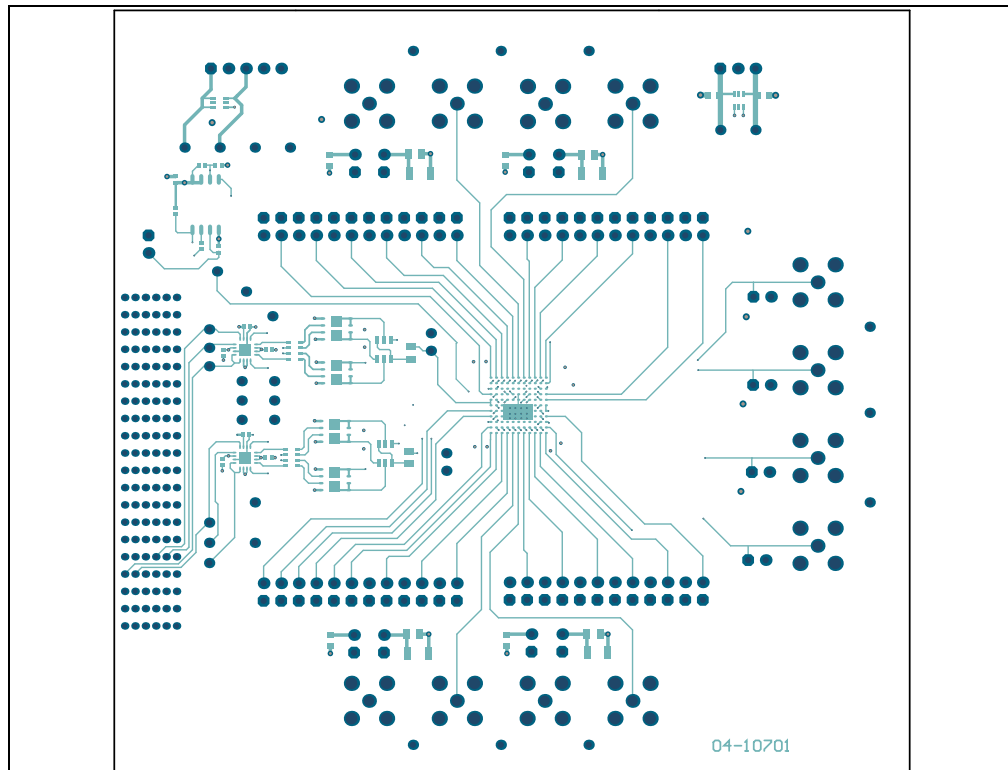

A.6 ADM00853 - INNER 1

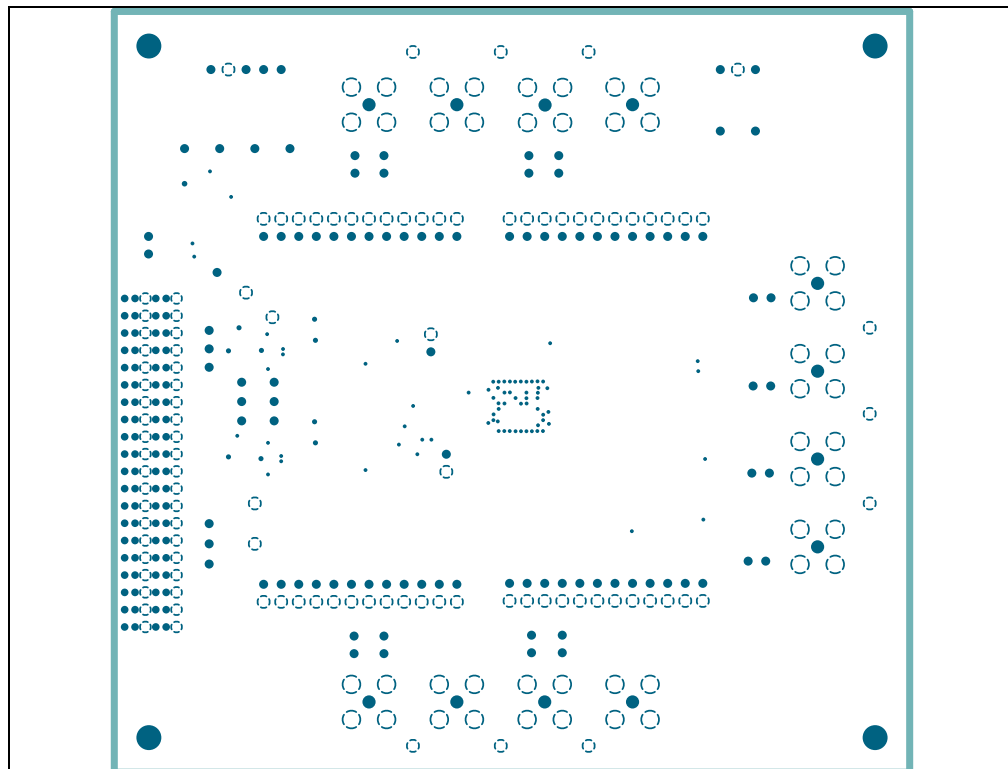

A.7 ADM00853 - INNER 2

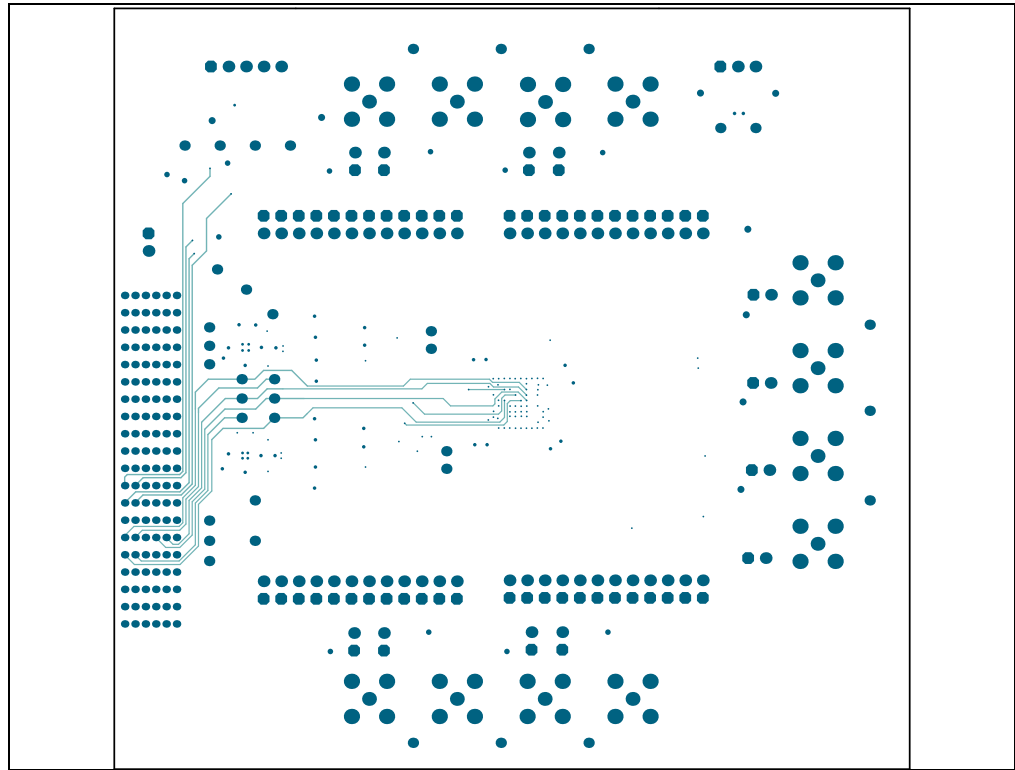

A.8 ADM00853 - INNER 3

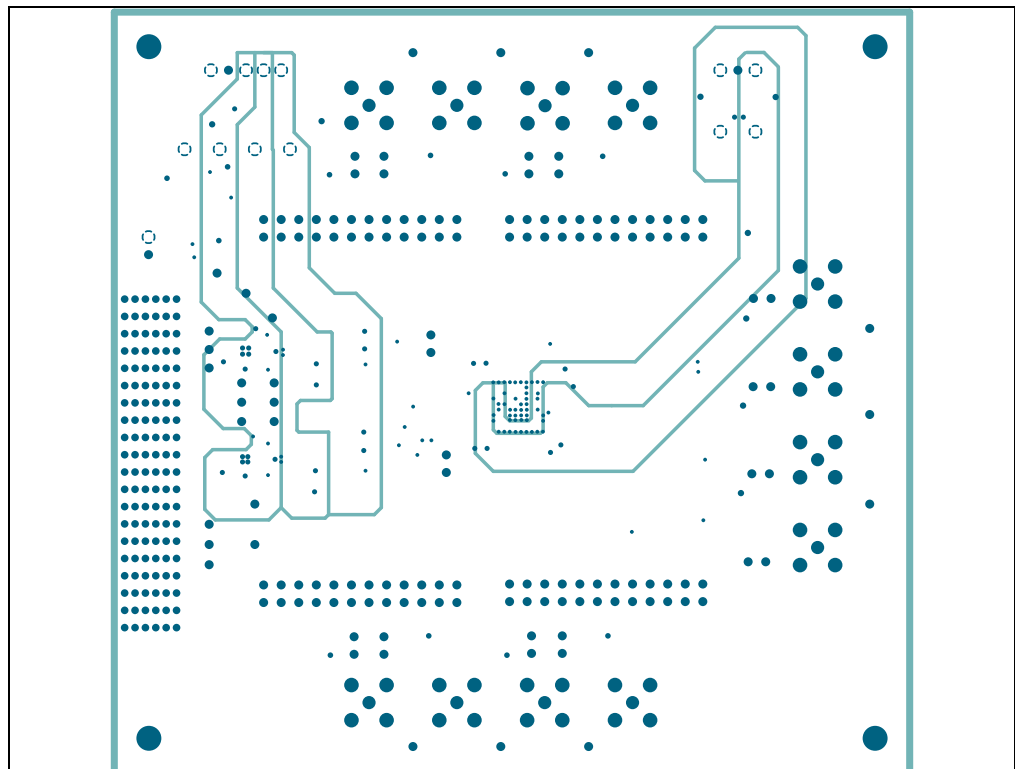

HV2070 Analog Switch Evaluation Board User's Guide

A.9 ADM00853 - BOTTOM COPPER

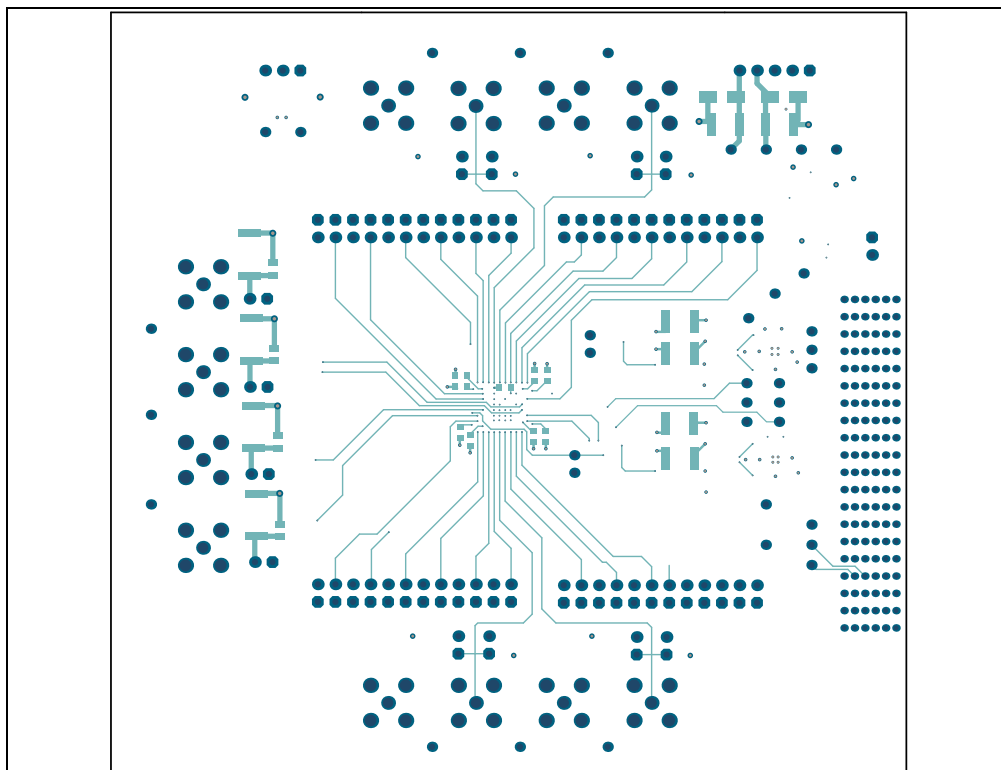

A.10 ADM00853 - BOTTOM COPPER AND SILK

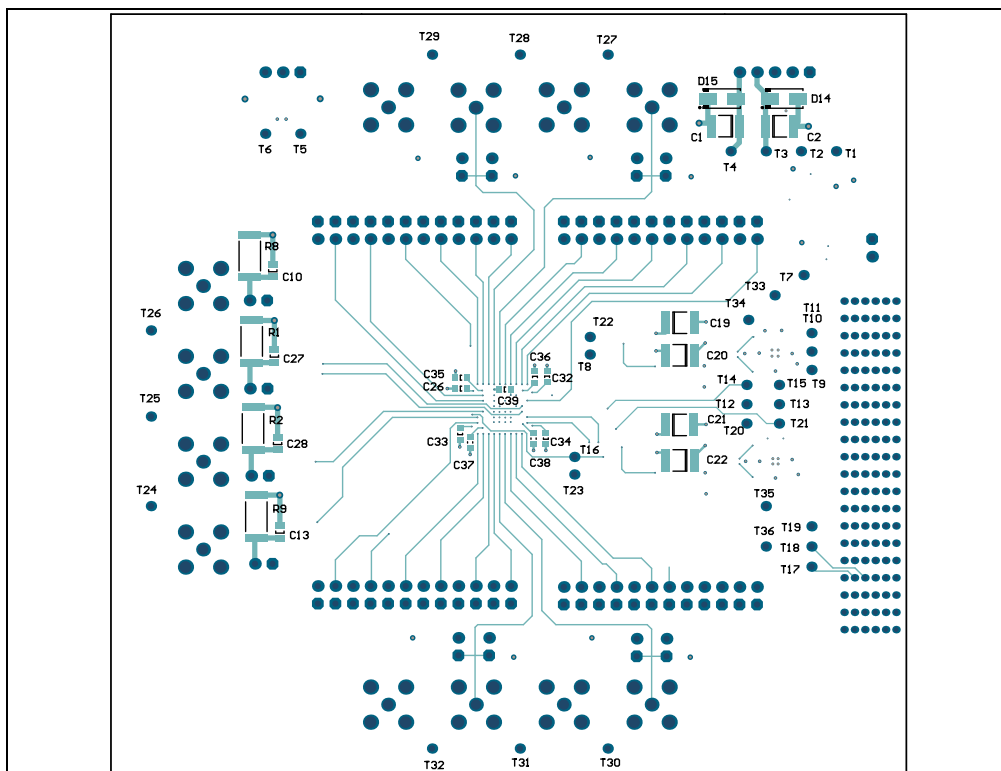

A.11 ADM00853 - BOTTOM SILK

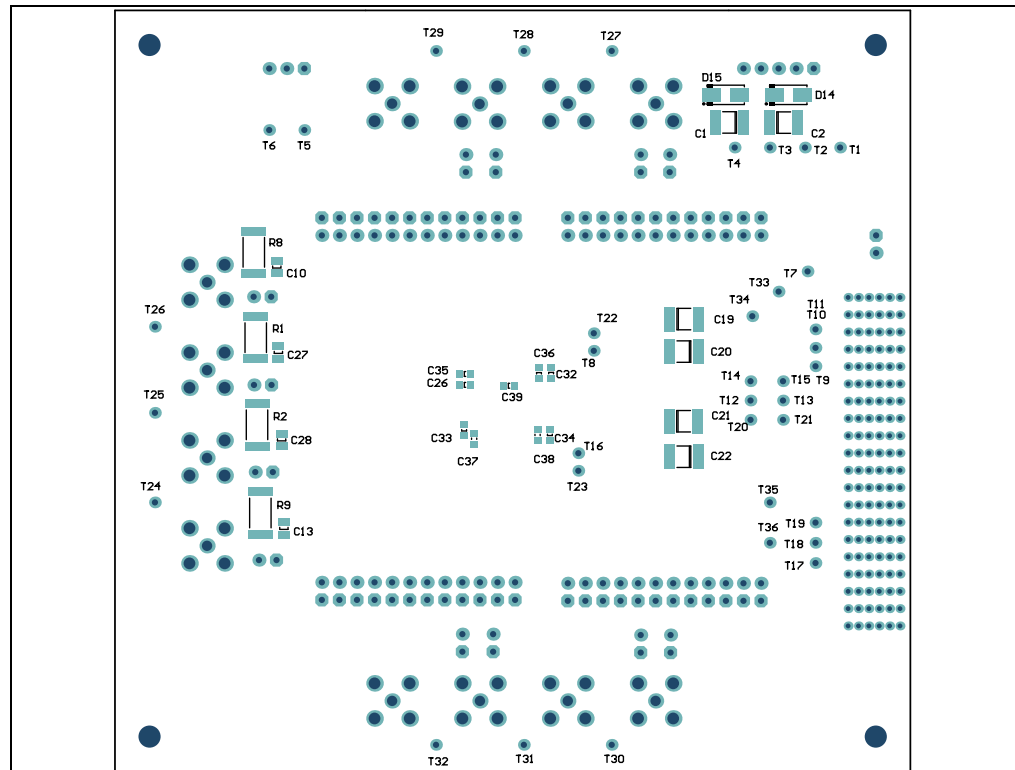

A.12 ADM00825 - SCHEMATIC (CONNECTION)

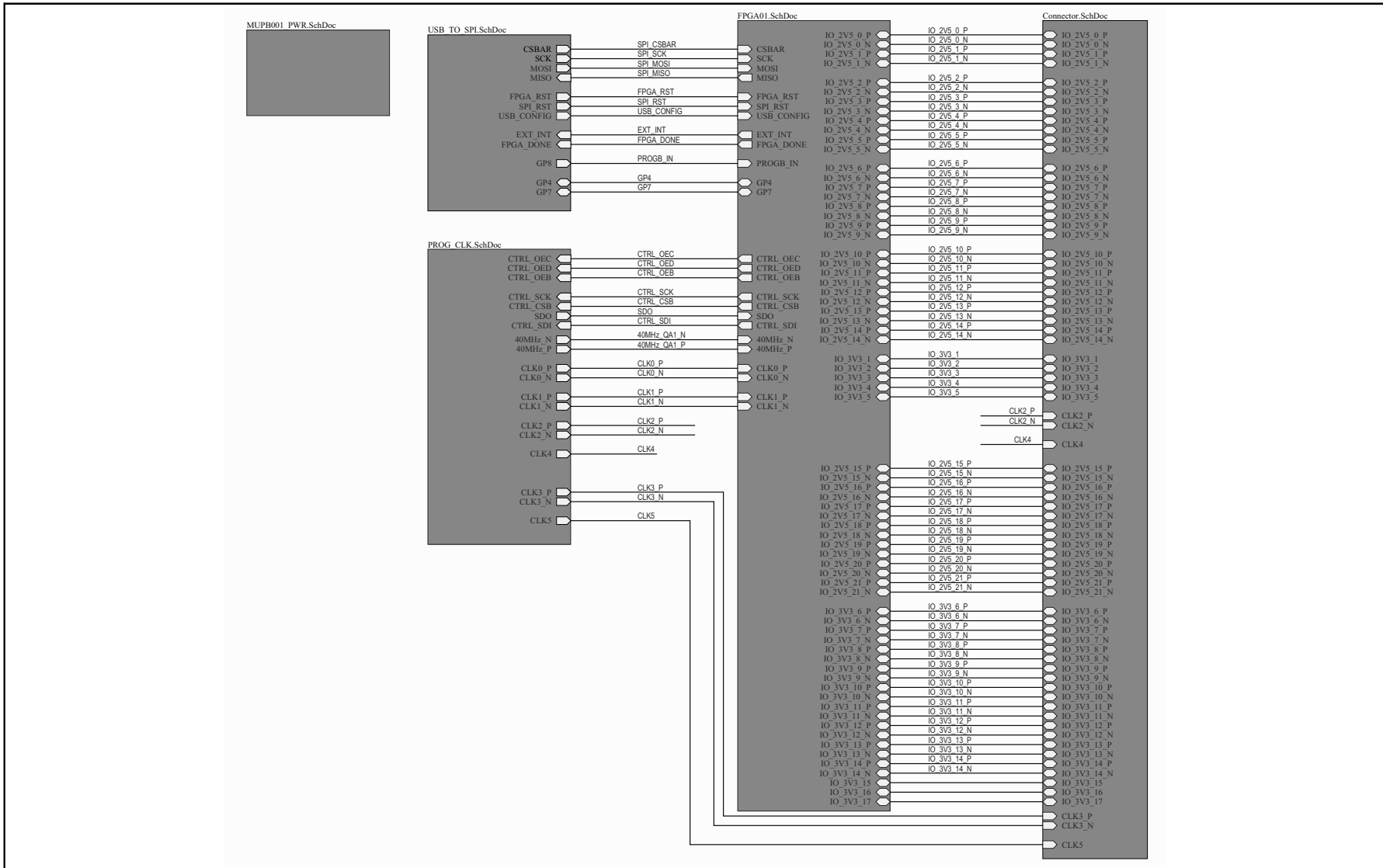

A.13 ADM00825 - SCHEMATIC (POWER SUPPLY)

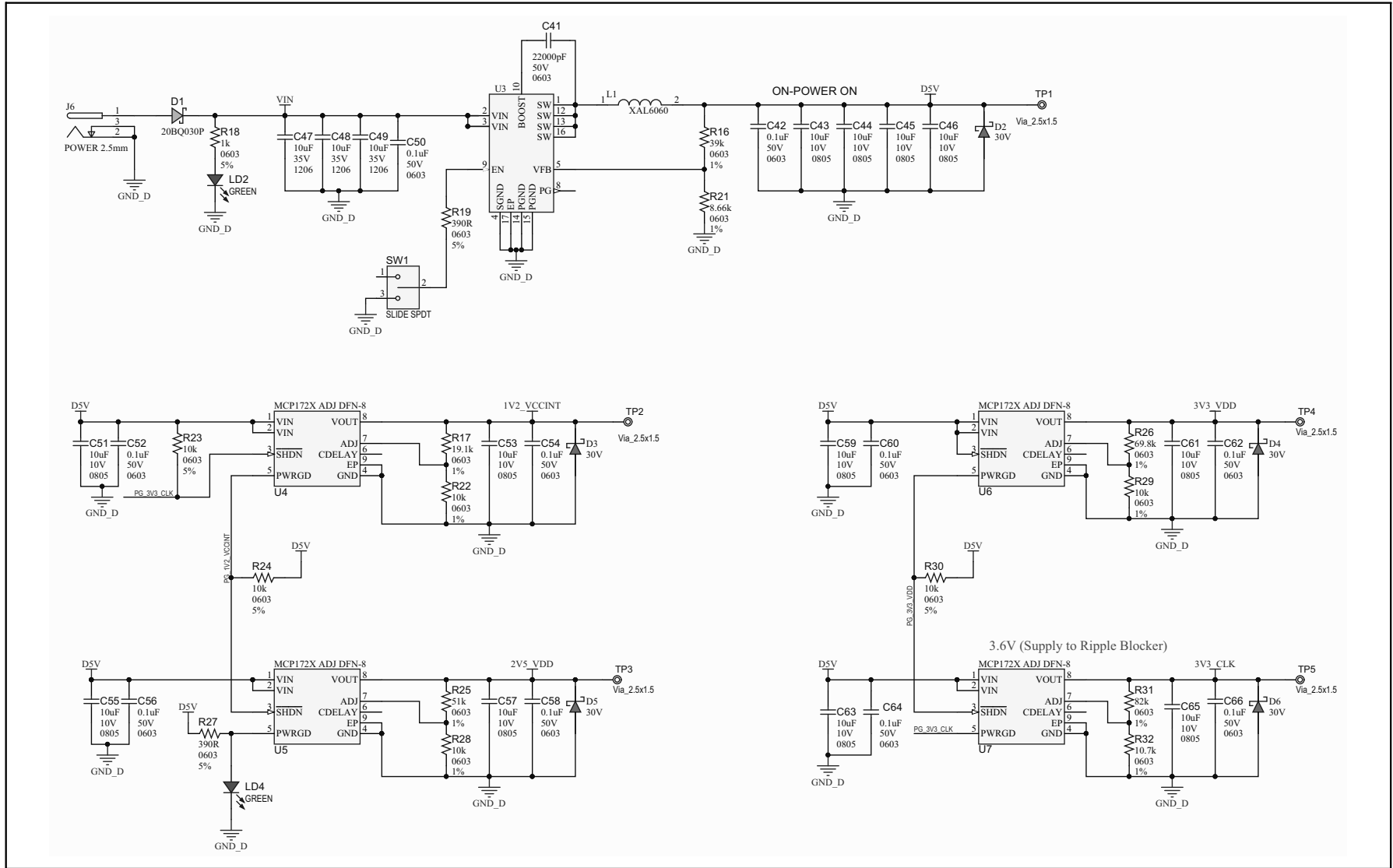

A.14 ADM00825 - SCHEMATIC (USB TO SPI)

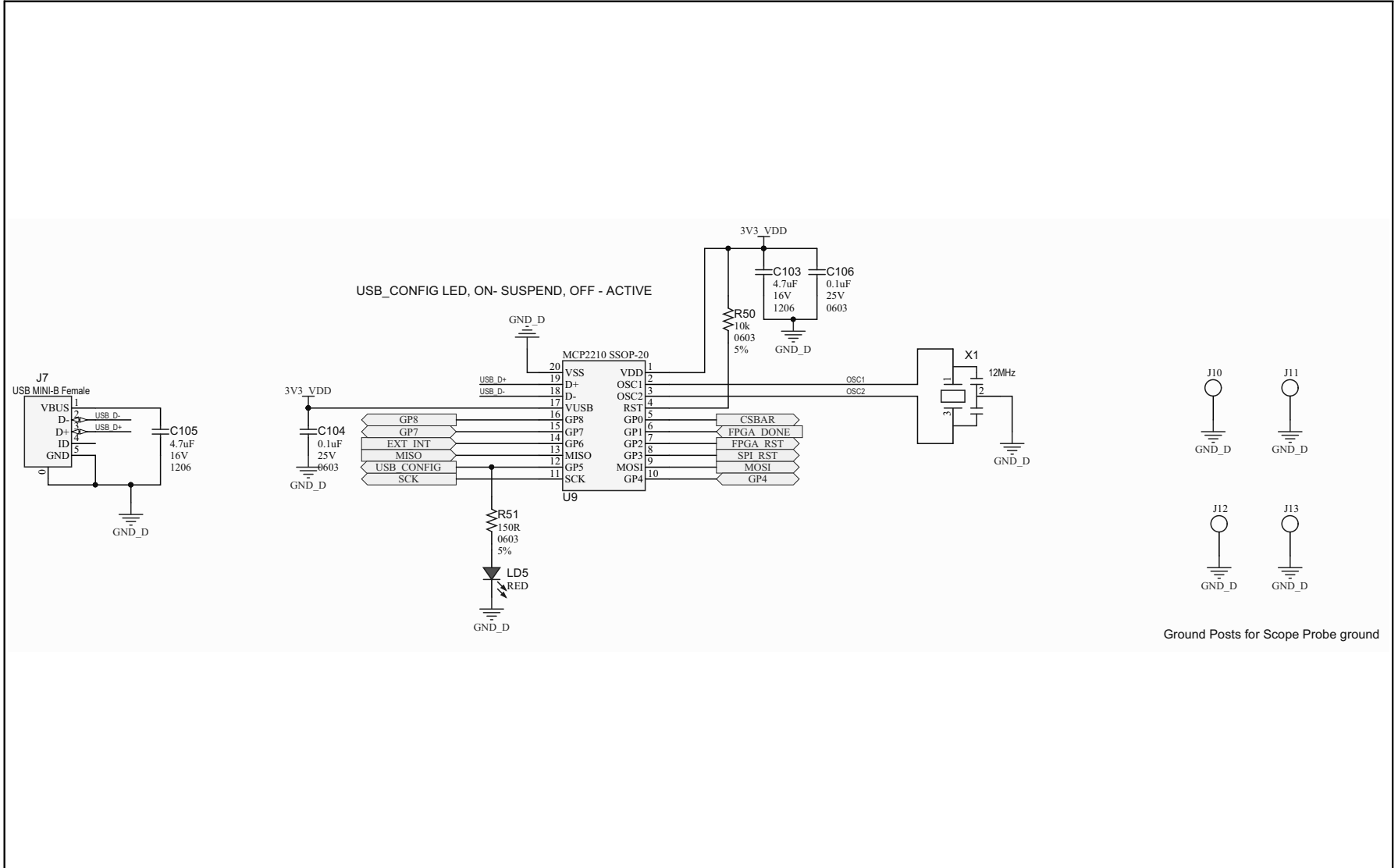

A.15 ADM00825 - SCHEMATIC (PROGRAMMABLE CLOCK)

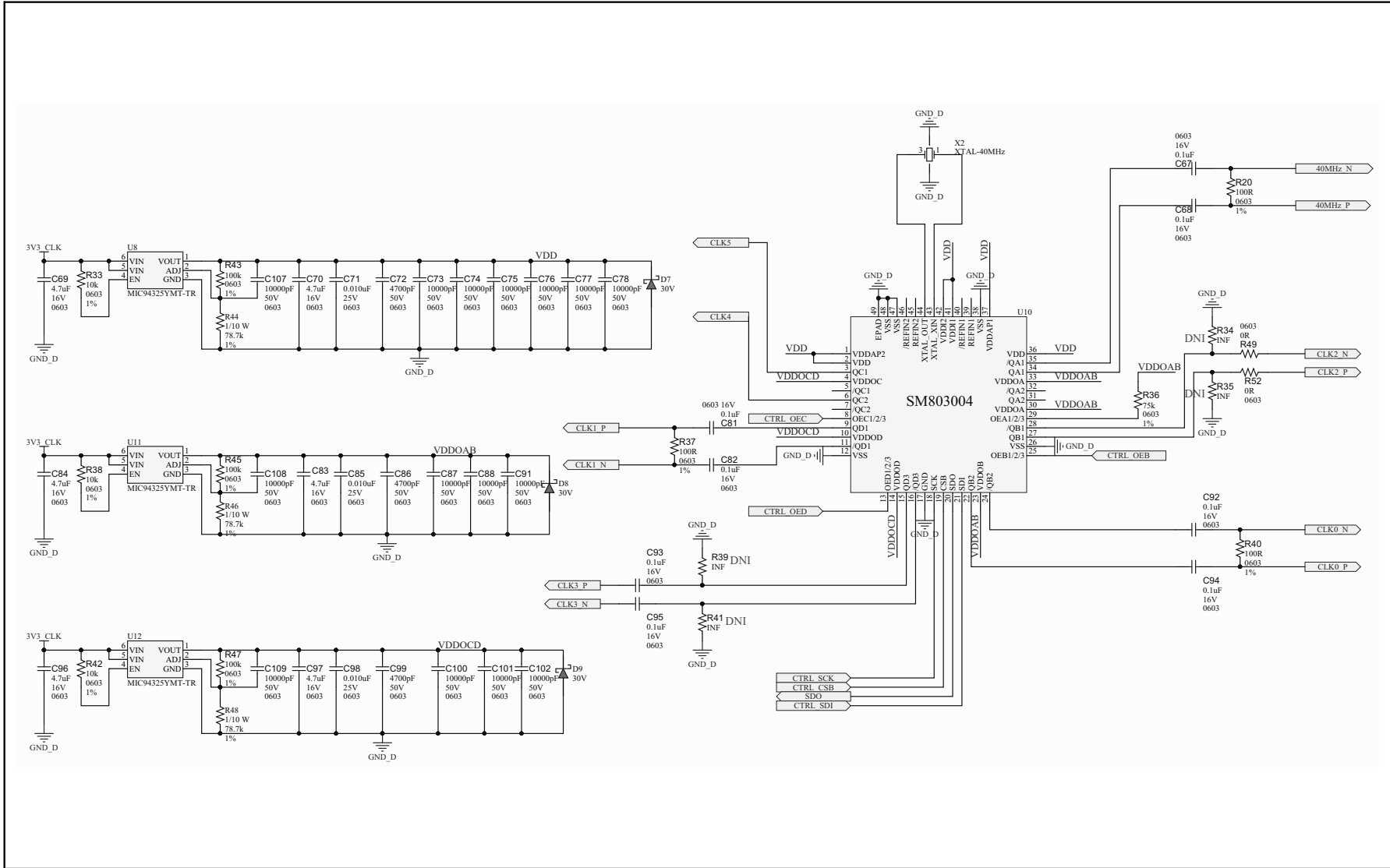

A.16 ADM00825 - SCHEMATIC (FPGA)

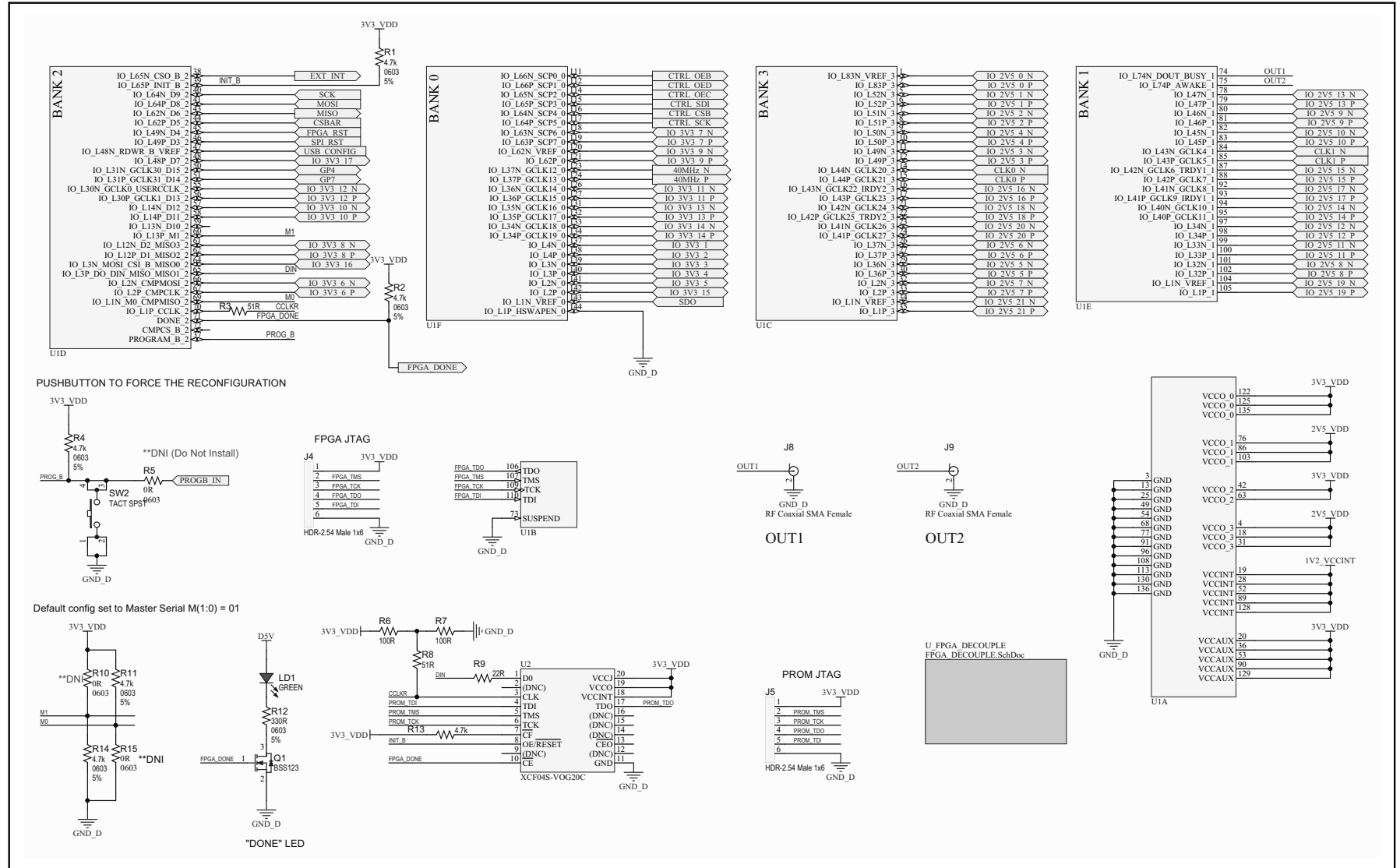

A.17 ADM00825 - SCHEMATIC (FPGA DECOUPLING CAPACITORS)

For 1V2_VCCINT

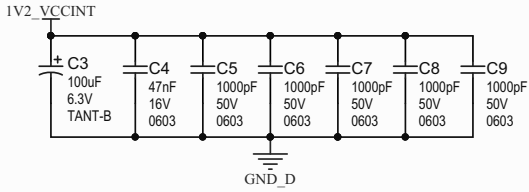

For VCCO_0

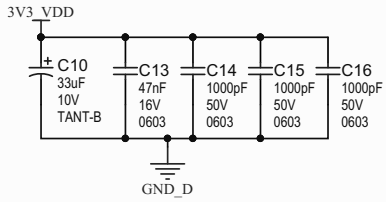

For VCCO_1

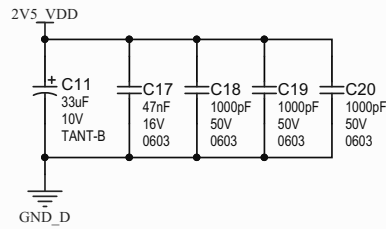

For VCCAUX

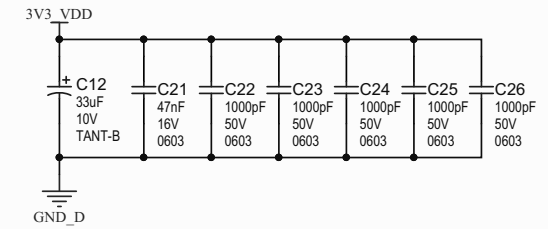

For VCCO_2

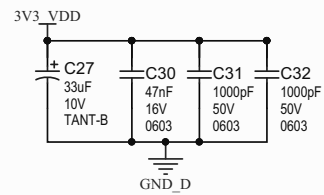

For VCCO_3

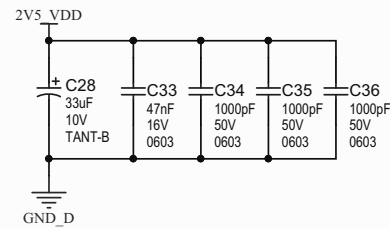

For XCF04S

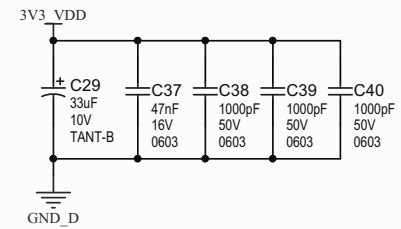

A.18 ADM00825 - SCHEMATIC (CONNECTORS)

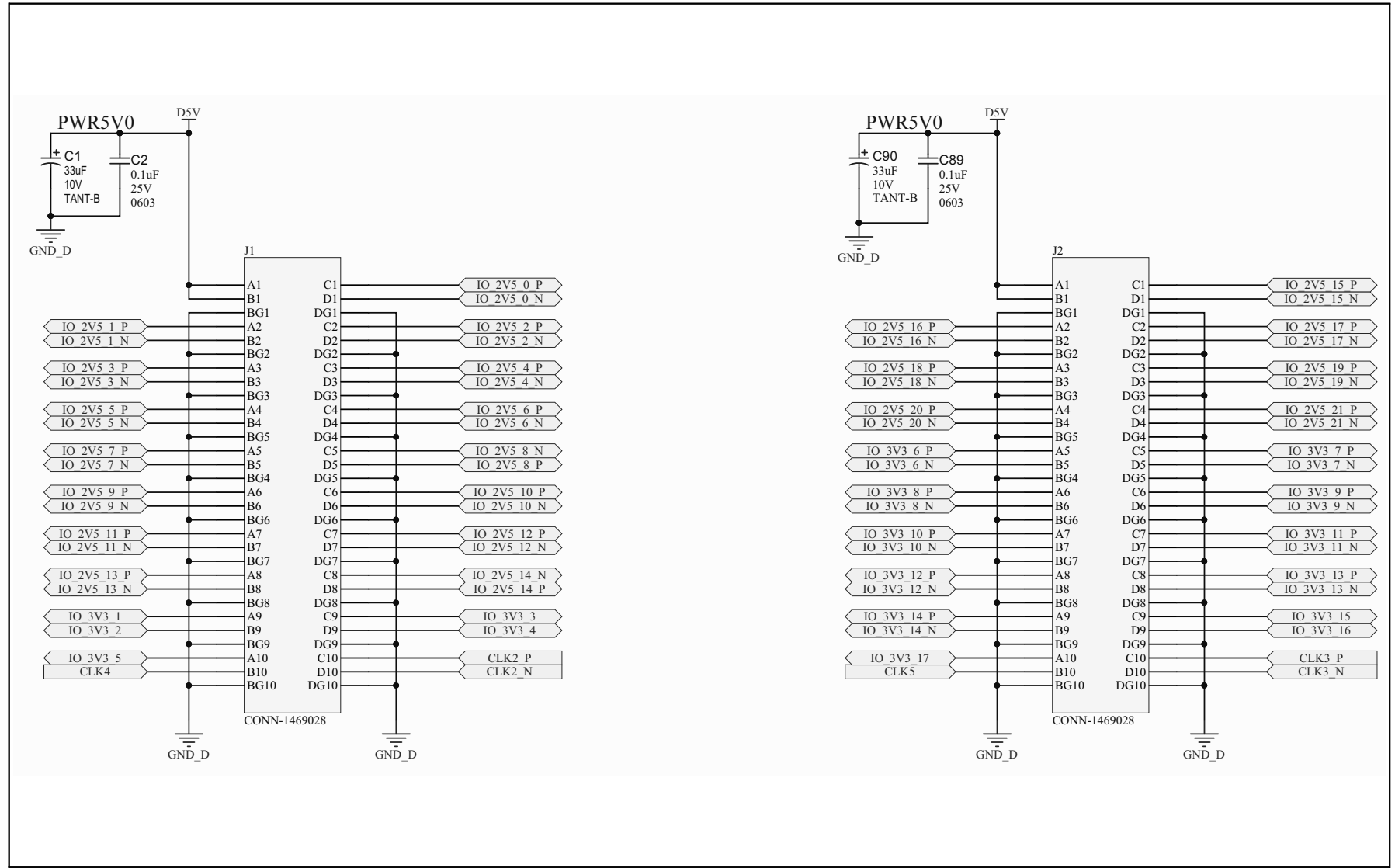

A.19 ADM00825 - TOP SILK

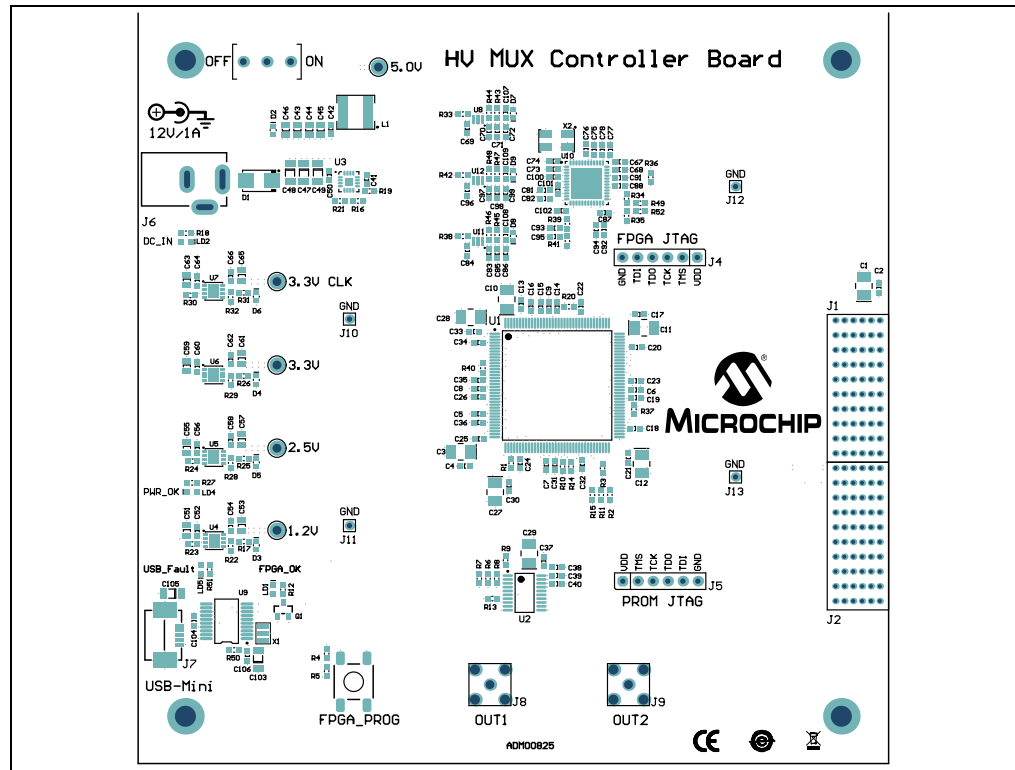

A.20 ADM00825 - TOP COPPER AND SILK

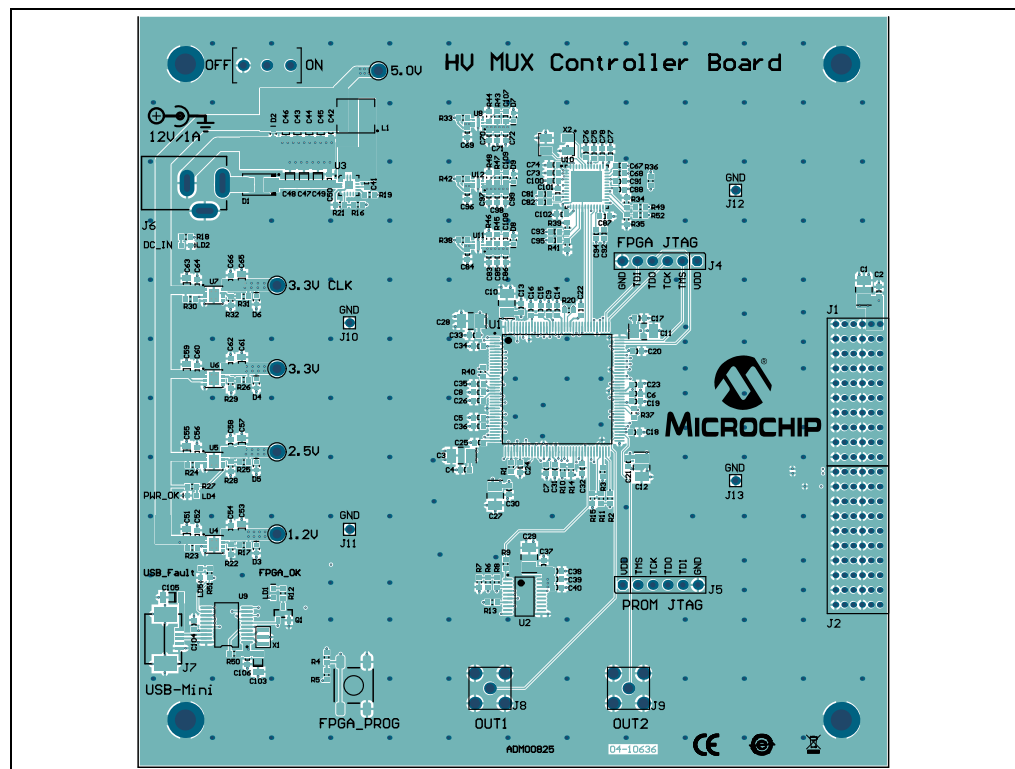

HV2070 Analog Switch Evaluation Board User's Guide

A.21 ADM00825 - TOP COPPER

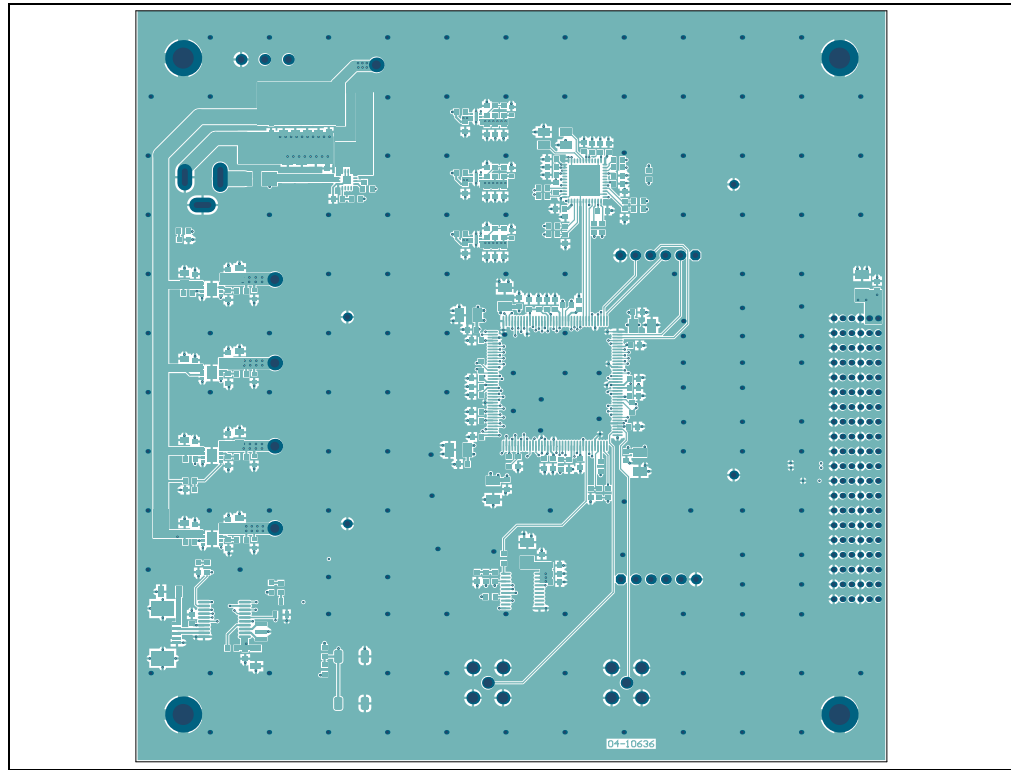

A.22 ADM00825 - INNER 1

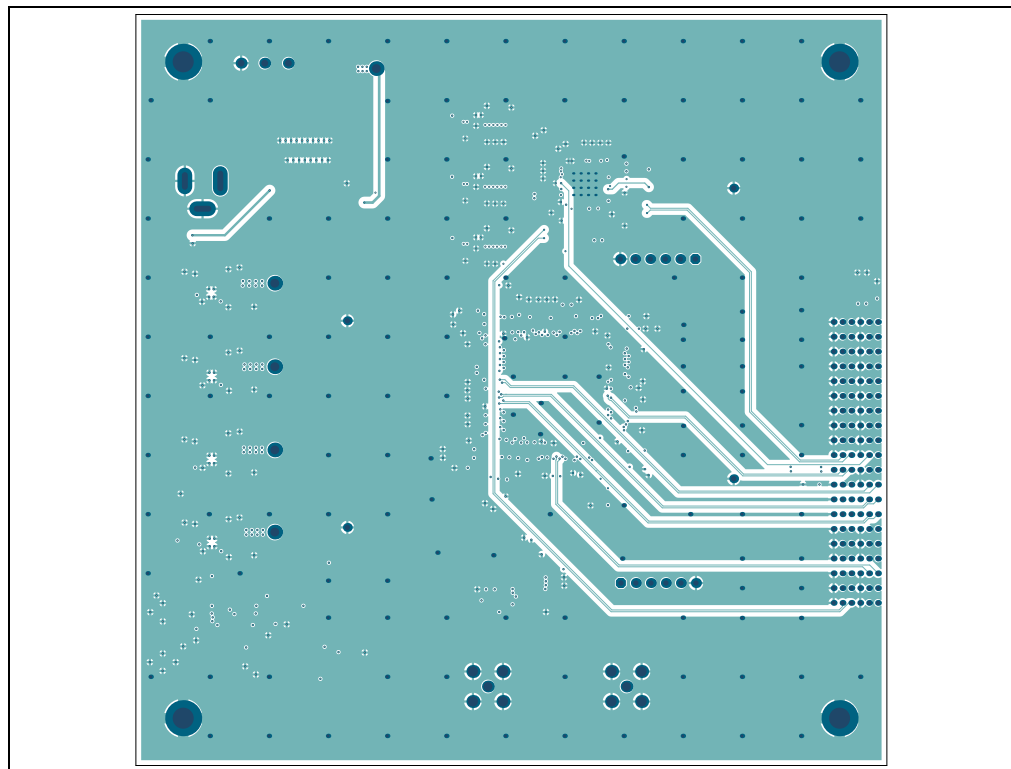

A.23 ADM00825 - INNER 2

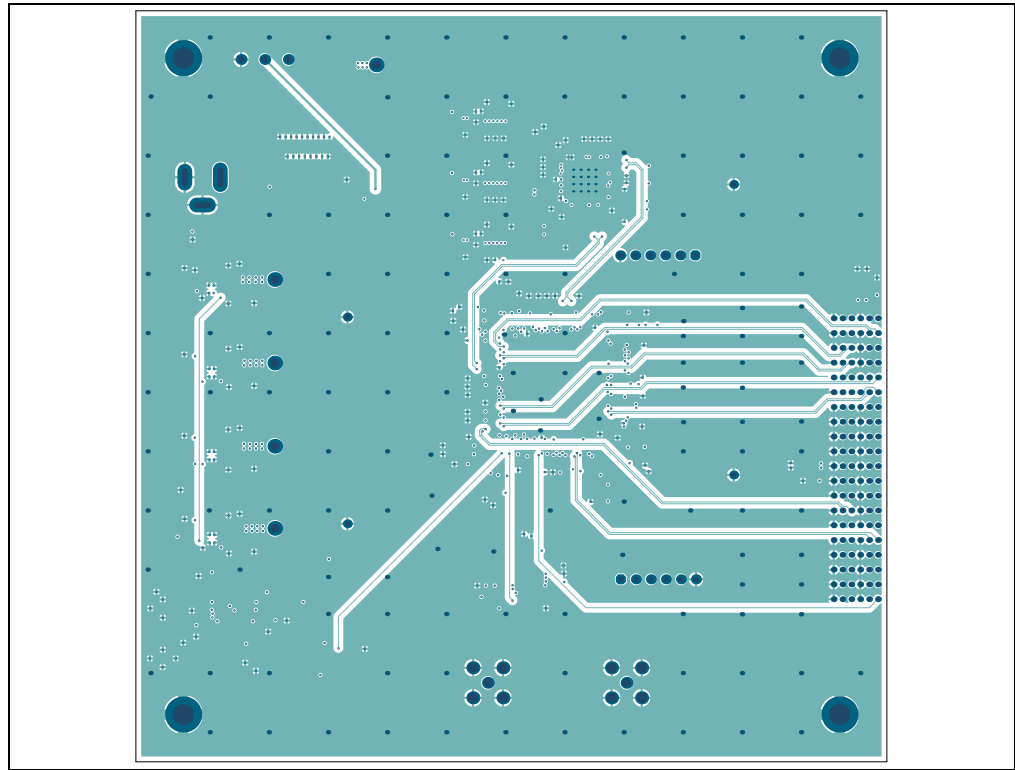

A.24 ADM00825 - INNER 3

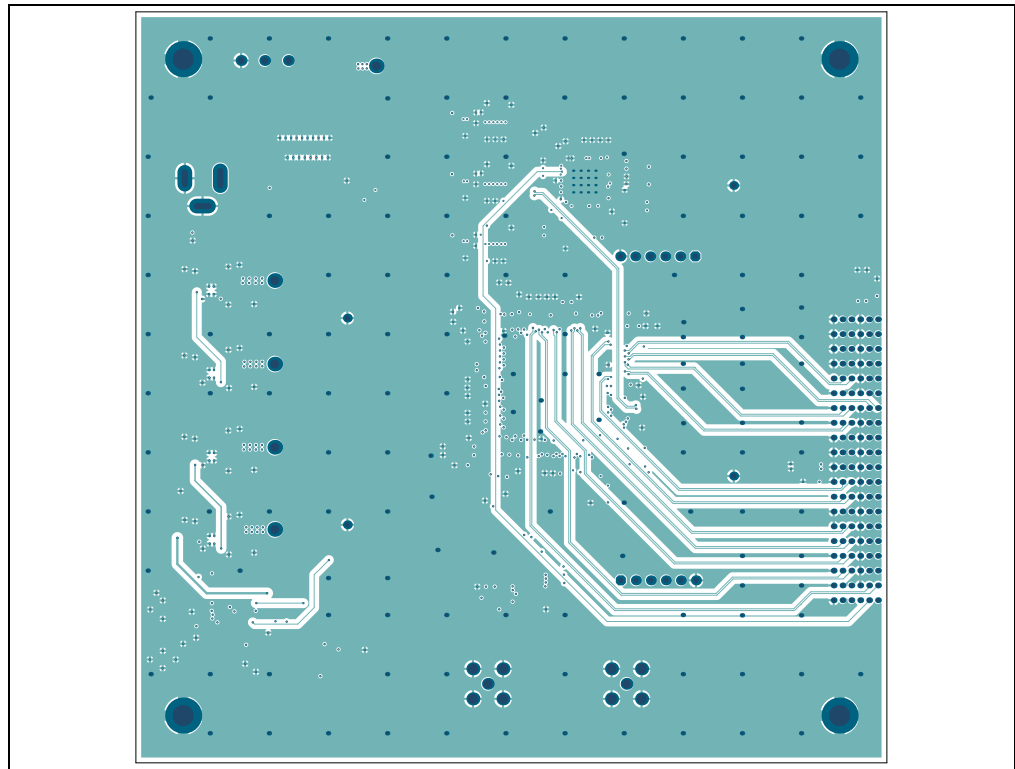

HV2070 Analog Switch Evaluation Board User's Guide

A.25 ADM00825 - INNER 4

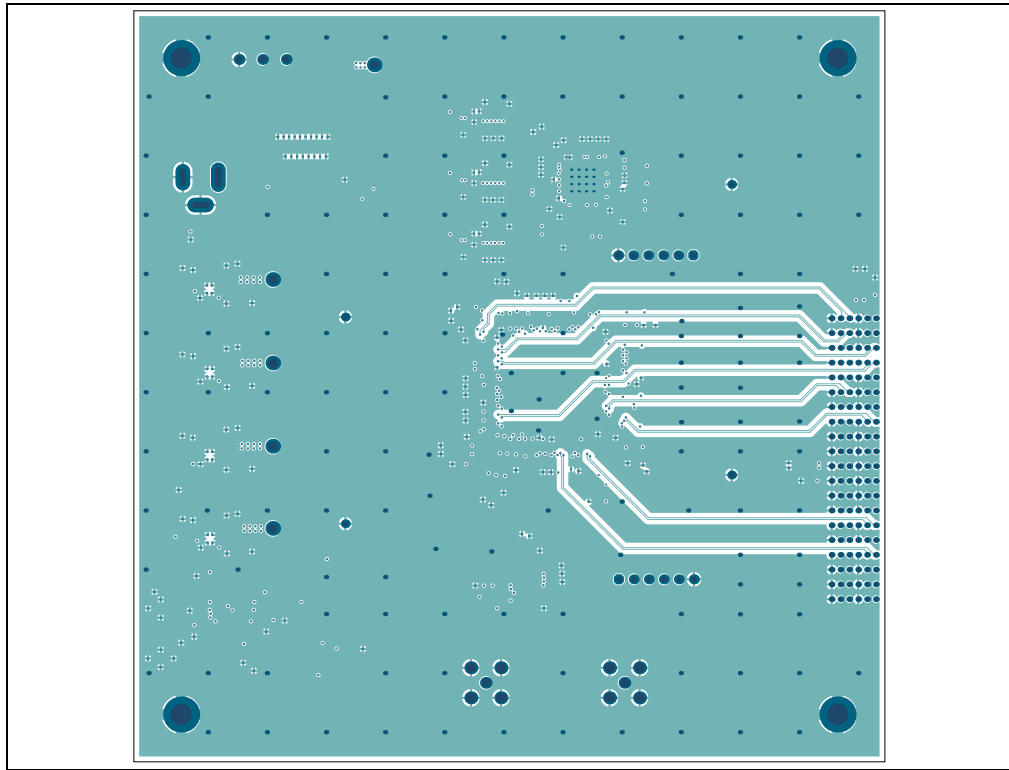

A.26 ADM00825 - BOTTOM COPPER

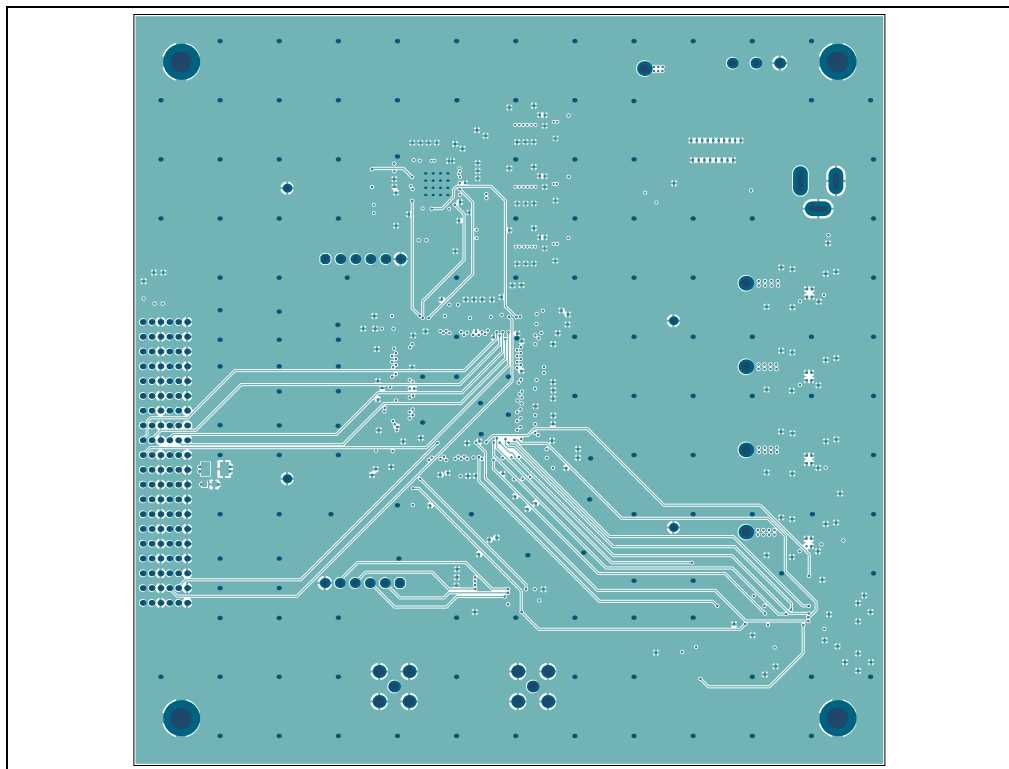

A.27 ADM00825 - BOTTOM COPPER AND SILK

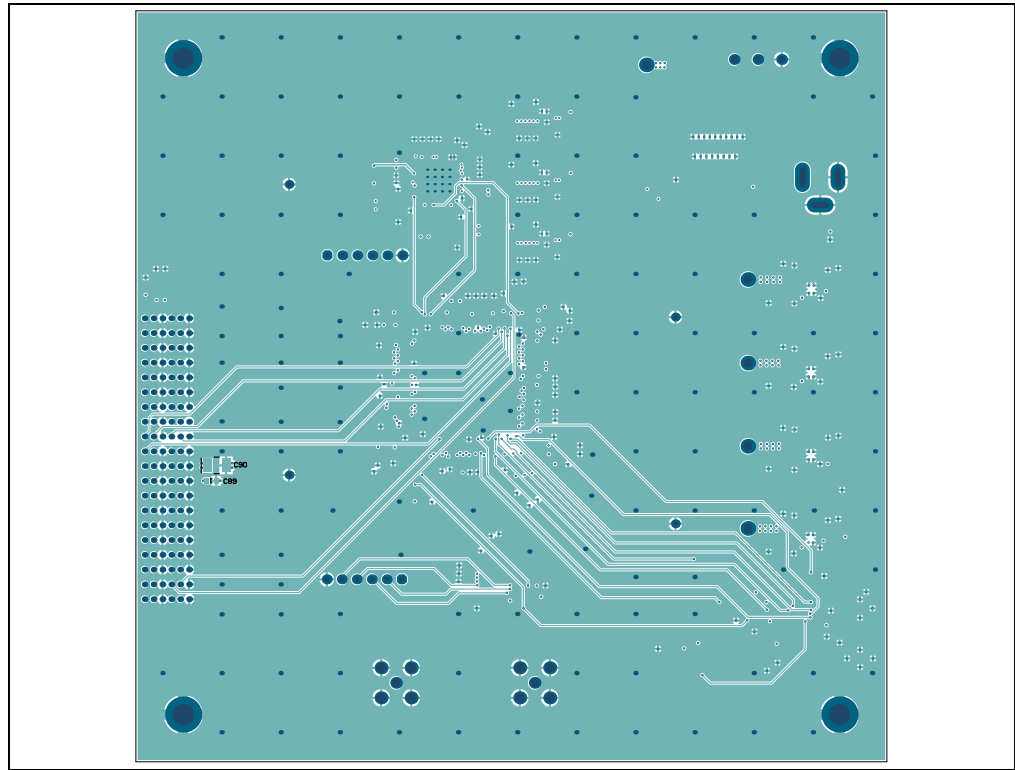

A.28 ADM00825 - BOTTOM SILK

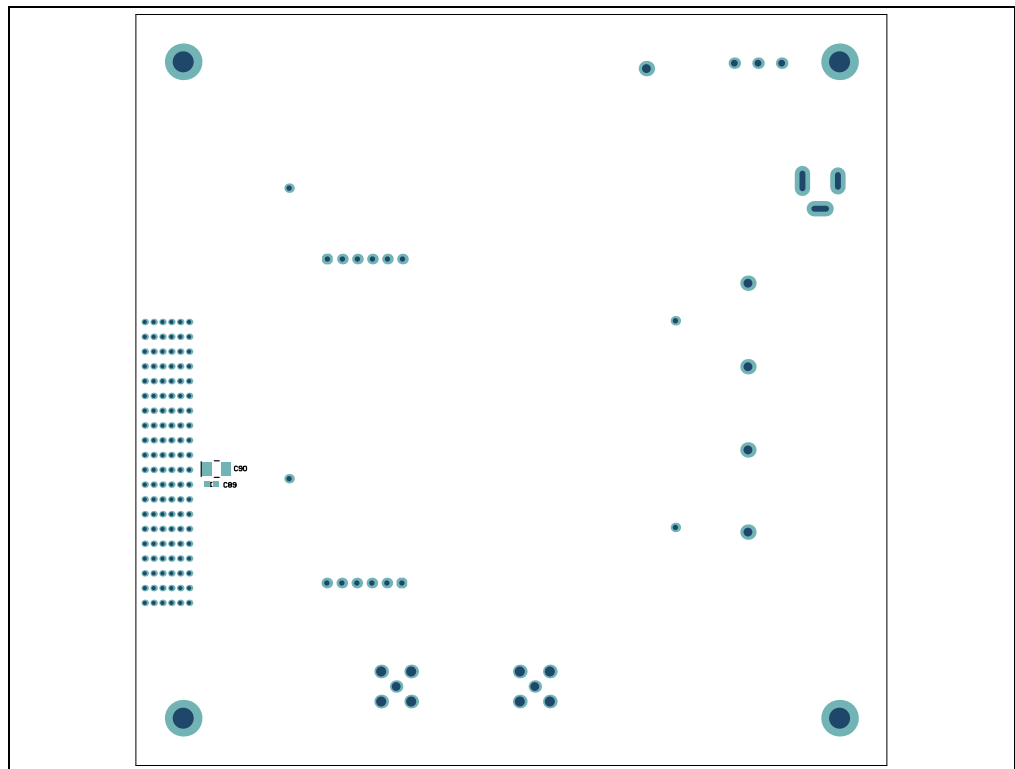

HV2070 Analog Switch Evaluation Board User's Guide

NOTES:



HV2070 ANALOG SWITCH EVALUATION BOARD USER'S GUIDE

Appendix B. Bill of Materials (BOM)

B.1 HV2070 ANALOG SWITCH EVALUATION BOARD (ADM00853)

TABLE B-1: ADM00853 – BILL OF MATERIALS (BOM)

Qty.	Reference	Description	Manufacturer	Part Number
6	C1, C2, C19, C20, C21, C22	Capacitor	TDK Corporation	C4532X7T2E105M250KA
4	C10, C13, C27, C28	Capacitor	Murata Manufacturing Co., Ltd.	GCM21A7U2E331JX01D
2	C15, C16	Capacitor-Array-10 nF	AVX Corporation	W3A41C103MAT2A
11	C25, C26, C31, C32, C33, C34, C35, C36, C37, C38, C39	Capacitor	Cal-Chip Electronics Inc.	GMC10Y5V104Z25NTLF
7	C3, C4, C6, C7, C8, C11, C14	Capacitor	TDK Corporation	CGA2B3X7R1V104K050BB
4	C5, C9, C12, C17	Capacitor	Panasonic® - ECG	ECU-V1H150JCN
2	D1, D2	MMBD3004BRM-300V	Diodes Incorporated®	MMBD3004BRM-7-F
2	D13, D16	—	Diodes Incorporated	BAT54DW-7FDICT-ND
2	D14, D15	Diode, Schottky, B1100, 790 mV, 1A, 70V DO-214AC_SMA	Diodes Incorporated	B1100-13-F
2	J1, J2	CONN, Header, 40 POS, 2 Row, R/A HM-ZD TIN	TE Connectivity, Ltd.	6469169-1
1	J3	—	Samtec, Inc.	TSW-103-07-T-S
1	J4	—	Samtec, Inc.	TSW-105-07-S-S
13	J5, J6, J7, J11, J8, J12, J13, J16, J25, J26, J27, J28, J29	—	FCI	77311-118-02LF
12	J9, J10, J14, J15, J17, J18, J19, J20, J21, J22, J23, J24	CONN, SMA	TE Connectivity, Ltd.	5-1814832-1
1	PCB	HV2070 Analog Switch Evaluation Board – Printed Circuit Board	Microchip Technology Inc.	04-10599
4	R1, R2, R8, R9	Resistor-2.55K 2W	Panasonic - ECG	ERJ-1TNF2551U
1	R16, R19	Resistor	Yageo Corporation	RC0402JR-074K7L
5	R17, R18	Resistor	Panasonic - ECG	—
1	R3	Resistor	Yageo Corporation	RC0402JR-070RL
4	R4, R10, R12, R14	Resistor	Vishay Intertechnology, Inc.	CRCW060349R9FKEAHP
2	R5, R6	Resistor, 4.99Ω, 1/16W, SMD0805	Stackpole Electronics, Inc.	RMCF0805FT4R99
4	R7, R11, R13, R15	Resistor	Yageo Corporation	RC1206FR-071KL

Note 1: The components listed in this Bill of Materials are representative of the PCB assembly. The released BOM used in manufacturing uses all RoHS-compliant components.

HV2070 Analog Switch Evaluation Board User's Guide

TABLE B-1: ADM00853 – BILL OF MATERIALS (BOM) (CONTINUED)

Qty.	Reference	Description	Manufacturer	Part Number
12	T24, T25, T26, T27, T28, T29, T30, T31, T32, T33, T34, T35, T36	Test Point	—	—
2	U1, U2	MD1822	Microchip Technology Inc.	MD1822K6-G
1	U13	HV2070	Microchip Technology Inc.	HV2070/AJA
1	U14	SQI Serial Flash	Micron Technology Inc.	N25Q128A13ESE40E
4	U5, U6, U7, U8	TC6320 DFN-8	Microchip Technology Inc.	TC6320K6-G

Note 1: The components listed in this Bill of Materials are representative of the PCB assembly. The released BOM used in manufacturing uses all RoHS-compliant components.

B.2 HV MUX CONTROLLER BOARD (ADM00825)

TABLE B-2: ADM00825 – BILL OF MATERIALS (BOM)

Qty.	Reference	Description	Manufacturer	Part Number
8	C1, C10, C11, C12, C27, C28, C29, C90	Capacitor, Tantalum, 33 μ F, 10V, 10%, 1.4 Ω , SMD, B	KEMET	T494B336K010AT
2	C103, C105	Capacitor, Ceramic, 4.7 μ F, 16V, 10%, X7R, SMD, 1206	KEMET	C1206C475K4RACTU
4	C2, C89, C104, C106	Capacitor, Ceramic, 0.1 μ F, 25V, 10%, X7R, SMD, 0603	Murata Manufacturing Co., Ltd.	GRM188R71E104KA01D
1	C3	Capacitor, Tantalum, 100 μ F, 6.3V, 10%, 400 m Ω , SMD, B	AVX Corporation	TPSB107K006R0400
7	C4, C13, C17, C21, C30, C33, C37	Capacitor, Ceramic, 47 nF, 16V, 10%, X7R, SMD, 0603	Murata Manufacturing Co., Ltd.	GRM188R71C473KA01D
1	C41	Capacitor, Ceramic, 22000 pF, 50V, 5%, X7R, SMD, 0603	AVX Corporation	06035C223JAT2A
10	C42, C50, C52, C54, C56, C58, C60, C62, C64, C66	Capacitor, Ceramic, 0.1 μ F, 50V, 20%, X7R, SMD, 0603	TDK Corporation	C1608X7R1H104M
12	C43, C44, C45, C46, C51, C53, C55, C57, C59, C61, C63, C65	Capacitor, Ceramic, 10 μ F, 10V, 10%, X7R, SMD, 0805	Murata Manufacturing Co., Ltd.	GRM21BR71A106KE51L
3	C47, C48, C49	Capacitor, Ceramic, 10 μ F, 35V, 10%, X5R, SMD, 1206	Taiyo Yuden Co., Ltd.	GMK316BJ106KL-T

Note 1: The components listed in this Bill of Materials are representative of the PCB assembly. The released BOM used in manufacturing uses all RoHS-compliant components.

TABLE B-2: ADM00825 – BILL OF MATERIALS (BOM) (CONTINUED)

Qty.	Reference	Description	Manufacturer	Part Number
24	C5, C6, C7, C8, C9, C14, C15, C16, C18, C19, C20, C22, C23, C24, C25, C26, C31, C32, C34, C35, C36, C38, C39, C40	Capacitor, Ceramic, 1000 pF, 50V, 10%, X7R, SMD, 0603	NIC Components Corp.	NMC0603X7R102K50TRPF
8	C67, C68, C81, C82, C92, C93, C94, C95	Capacitor, Ceramic, 0.1 µF, 16V, 10%, X7R, SMD, 0603	Samsung Electro-Mechanics America, Inc.	CL10B104KO8NNNC
9	C69, C70, C83, C84, C96, C97, 107, 108, 109	Capacitor, Ceramic, 4.7 µF, 16V, 10%, X5R, SMD, 0603	TDK Corporation	C1608X5R1C475K080AC
3	C71, C85, C98	Capacitor, Ceramic, 0.010 µF, 25V, 10%, X7R, SMD, 0603	Yageo Corporation	CC0603KRX7R8BB103
3	C72, C86, C99	Capacitor, Ceramic, 4700 pF, 50V, 10%, X7R, SMD, 0603	KEMET	C0603C472K5RACTU
12	C73, C74, C75, C76, C77, C78, C87, C88, C91, C100, C101, C102	Capacitor, Ceramic, 10000 pF, 50V, 10%, X7R, 0603	AVX Corporation	06035C103KAT2A
1	D1	Diode, Schottky, 20BQ030P, 470 mV, 2A, 30V, DO-214AA_SMB	ON Semiconductor®	MBRS130LT3G
8	D2, D3, D4, D5, D6, D7, D8, D9	Diode, Schottky, 30V, 200 mA, SOD523	Micro Commercial Components	BAT54WX-TP
2	J1, J2	Connector, Receptacle, 40, POS, 2 Row, RT, ANG, T/H	TE Connectivity, Ltd.	1469028-1
4	J10, J11, J12, J13	Connector, PC, Pin, Circuit, 0.030, DIA, Gold	Mill-Max Mfg. Corporation	3132-0-00-15-00-00-08-0
2	J4, J5	CON, HDR-2.54, Male, 1x6, Tin, 5.84, MH, TH, VERT	Sullins Connector Solutions	PEC06SAAN
1	J6	CON, Power, 2.5 mm, 5.5 mm, Switch, TH, R/A	CUI Inc.	PJ-002B
1	J7	CON, USB, Mini-B, Female, SMD, R/A	Hirose Electric Co., Ltd.	UX60SC-MB-5ST(80)
2	J8, J9	CON, RF, Coaxial, SMA, Female, 2P, TH, VERT	TE Connectivity, Ltd.	5-1814832-1
1	L1	4.7 µH, 11A, Inductor	Coilcraft	XAL6060-472MEB
3	LD1, LD2, LD4	Diode, LED, Green, 2.2V, 25 mA, 15 mcd, Clear, SMD, 0603	Kingbright Electronic Co., Ltd.	APT1608SGC
1	LD5	Diode, LED, Red, 2V, 25 mA, 104 mcd, Diffuse, SMD, 0603	OSRAM Opto Semiconductors GmbH.	LS Q976-NR-1-0-20-R18
1	PCB	HV MUX Controller Board – Printed Circuit Board	Microchip Technology Inc.	04-10636
1	Q1	Transistor, FET, N-CH, BSS123, 100V, 170 mA, 300 mW, SOT-23-3	Diodes Incorporated®	BSS123-7-F

Note 1: The components listed in this Bill of Materials are representative of the PCB assembly. The released BOM used in manufacturing uses all RoHS-compliant components.

HV2070 Analog Switch Evaluation Board User's Guide

TABLE B-2: ADM00825 – BILL OF MATERIALS (BOM) (CONTINUED)

Qty.	Reference	Description	Manufacturer	Part Number
6	R1, R2, R4, R11, R13, R14	Resistor, TKF, 4.7 k Ω , 5%, 1/10W, SMD, 0603	Panasonic® - ECG	ERJ-3GEYJ472V
1	R12	Resistor, MF, 330R, 5%, 1/16W, SMD, 0603	Panasonic - ECG	ERA-V33J331V
1	R16	Resistor, TKF, 39 k Ω , 1%, 1/10W, SMD, 0603	Panasonic - ECG	ERJ-3EKF3902V
1	R17	Resistor, TKF, 19.1 k Ω , 1%, 1/10W, SMD, 0603	Panasonic - ECG	ERJ-3EKF1912V
1	R18	Resistor, TKF, 1 k Ω , 5%, 1/10W, SMD, 0603	Panasonic - ECG	ERJ-3GEYJ102V
2	R19, R27	Resistor, TKF, 390R, 5%, 1/10W, SMD, 0603	Panasonic - ECG	ERJ-3GEYJ391V
3	R20, R37, R40	Resistor, TKF, 100R, 1%, 1/10W, SMD, 0603	Panasonic - ECG	ERJ-3EKF1000V
1	R21	Resistor, TKF, 8.66 k Ω , 1%, 1/10W, SMD, 0603	Yageo Corporation	RC0603FR-078K66L
6	R22, R28, R29, R33, R38, R42	Resistor, TF, 10 k Ω , 1%, 1/8W, SMD, 0603	Vishay Beyschlag	MCT06030C1002FP500
4	R23, R24, R30, R50	Resistor, TKF, 10 k Ω , 5%, 1/10W, SMD, 0603	Panasonic - ECG	ERJ-3GEYJ103V
1	R25	Resistor, TKF, 51 k Ω , 1%, 1/10W, SMD, 0603	Panasonic - ECG	ERJ-3EKF5102V
1	R26	Resistor, TKF, 69.8 k Ω , 1%, 1/10W, SMD, 0603	Panasonic - ECG	ERJ-3EKF6982V
2	R3, R8	Resistor, TKF, 51R, 5%, 1/10W, SMD, 0603	Panasonic - ECG	ERJ-3GEYJ510V
1	R31	Resistor, TKF, 82 k Ω , 1%, 1/10W, SMD, 0603	Panasonic - ECG	ERJ-3EKF8202V
1	R32	Resistor, TKF, 10.7 k Ω , 1%, 1/10W, SMD, 0603	Panasonic - ECG	ERJ-3EKF1072V
4	R34, R35, R39, R41	Resistor, TKF, 150R, 1%, 1/10W, SMD, 0603	Stackpole Electronics, Inc.	RMCF0603FT150R
1	R36	Resistor, TKF, 75 k Ω , 1%, 1/10W, SMD, 0603	Panasonic - ECG	ERJ-3EKF7502V
3	R43, R45, R47	Resistor, TKF, 100 k Ω , 1%, 1/10W, SMD, 0603	Panasonic - ECG	—
3	R44, R46, R48	Resistor, 78.7 k Ω , 1%, 1/10W, SMD, 0603	Yageo Corporation	RC0603FR-0778K7L
2	R49, R52	Resistor, SMD, 0.0 Ω , Jumper, 1/10W, 0603	Panasonic - ECG	ERJ-3GEY0R00V
3	R5, R10, R15	Resistor, TKF, 0R, 1/10W, SMD, 0603	NIC Components Corp.	NRC06Z0TRF
1	R51	Resistor, TKF, 150R, 5%, 1/10W, SMD, 0603	Panasonic - ECG	ERJ-3GEYJ151V
2	R6, R7	Resistor, TKF, 100R, 5%, 1/10W, SMD, 0603	Vishay Intertechnology, Inc.	CRCW0603100RJNEA
1	R9	Resistor, TKF, 22R, 5%, 1/10W, SMD, 0603	Panasonic - ECG	ERJ-3GSYJ220V

Note 1: The components listed in this Bill of Materials are representative of the PCB assembly. The released BOM used in manufacturing uses all RoHS-compliant components.

TABLE B-2: ADM00825 – BILL OF MATERIALS (BOM) (CONTINUED)

Qty.	Reference	Description	Manufacturer	Part Number
1	SW1	Switch, Slide, SPDT, Mini, 50V, 0.5A, G4050X-R TH	Jameco® Electronics	G4050X-R
1	SW2	Switch, Tact, SPST, 12V, 50 mA, TL3301NF, 160QG/TR, SMD	E-Switch®, Inc.	TL3301NF260QG/TR
1	U1	IC FPGA, 102, I/O, 144T, QFP	Xilinx Inc.	XC6SLX9-2TQG144C
1	U10	Flexible Ultra-low Jitter Clock Generator	Microchip Technology Inc.	SM803234
1	U2	IC, PROM SRL For 4M Gate	Xilinx Inc.	XCF04SVOG20C
1	U3	3A Buck, 5V, QFN-16	Semtech Corporation	TS30013-M000QFNR
4	U4, U5, U6, U7	Microchip Analog LDO 0.8V-5V MCP1727T-ADJE/MF DFN-8	Microchip Technology Inc.	MCP1727-ADJE/MF
3	U8, U11, U12	Adjustable LDO Ripple Blocker	Microchip Technology Inc.	MIC94325YMT-TR
1	U9	Microchip Interface USB SPI MCP2210-I/SS SSOP-20	Microchip Technology Inc.	MCP2210T-I/SS
1	X1	Resonator, 12 MHz, 0.1%, SMD, CSTCE-G	Murata Manufacturing Co., Ltd.	CSTCE12M0G15L99-R0
1	X2	40 MHz, ±30 ppm, Crystal, 12 pF, 40Ω, -20°C, 70°C, Surface Mount, 4-SMD	TXC Corporation	7B-40.000MAAE-T

Note 1: The components listed in this Bill of Materials are representative of the PCB assembly. The released BOM used in manufacturing uses all RoHS-compliant components.

HV2070 Analog Switch Evaluation Board User's Guide

NOTES:

Appendix C. Demo Board Waveforms

C.1 BOARD TYPICAL WAVEFORMS

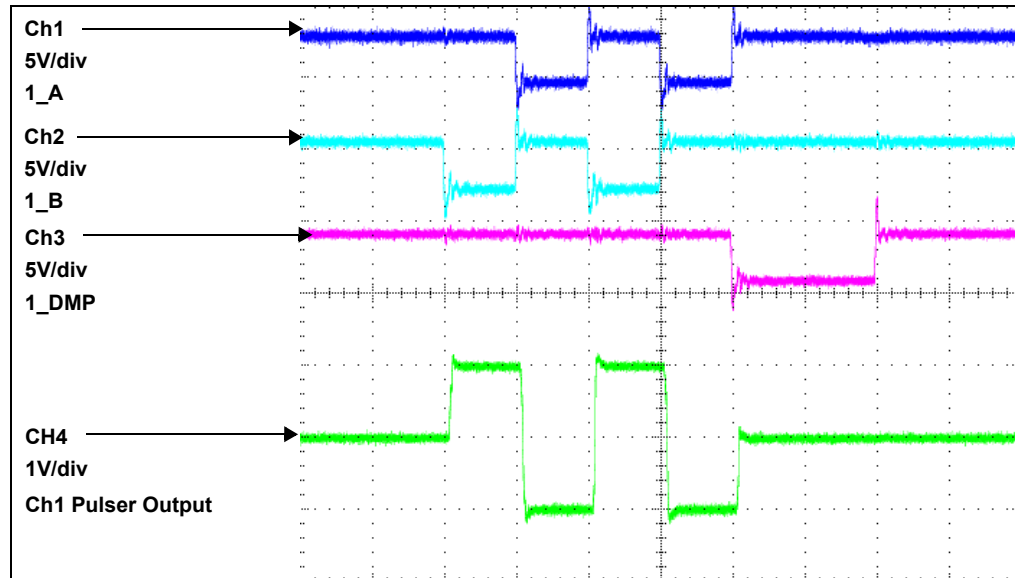

FIGURE C-1: 5 MHz 4 Pulses Ch1 Pulser Input and Output When All SW OFF.

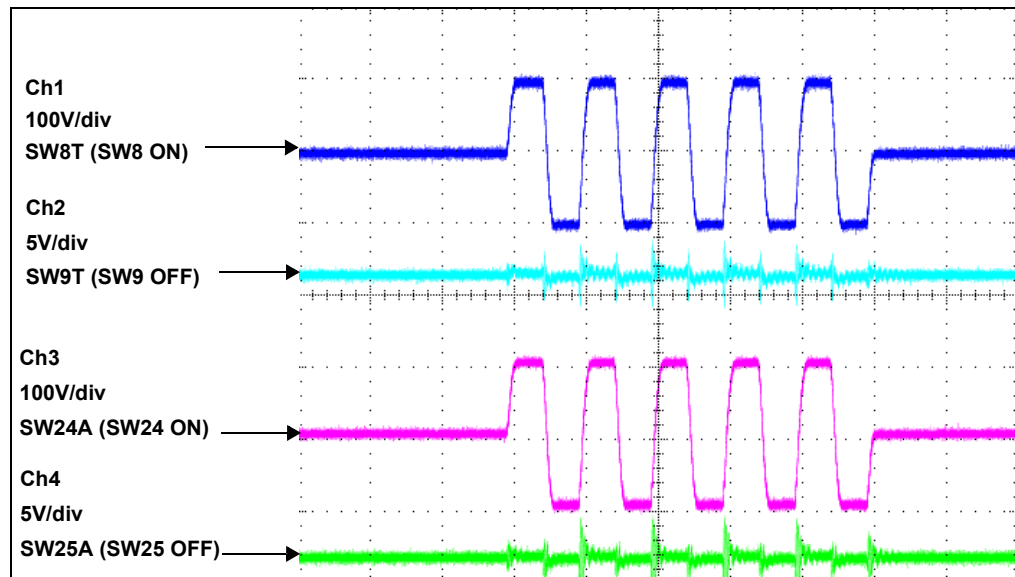

FIGURE C-2: 5 MHz 10 Pulses, $V_{PP}/V_{NN} = \pm 100V$, $V_{DD}/V_{SS} = \pm 6V$, $V_{GP} = 10V$, $330\text{ pF}/2.5\text{ K}\Omega$ Load.

HV2070 Analog Switch Evaluation Board User's Guide

NOTES:



MICROCHIP

Worldwide Sales and Service

AMERICAS

Corporate Office
2355 West Chandler Blvd.
Chandler, AZ 85224-6199
Tel: 480-792-7200
Fax: 480-792-7277
Technical Support:
<http://www.microchip.com/support>
Web Address:
www.microchip.com

Atlanta

Duluth, GA
Tel: 678-957-9614
Fax: 678-957-1455

Austin, TX

Tel: 512-257-3370

Boston

Westborough, MA
Tel: 774-760-0087
Fax: 774-760-0088

Chicago

Itasca, IL
Tel: 630-285-0071
Fax: 630-285-0075

Dallas

Addison, TX
Tel: 972-818-7423
Fax: 972-818-2924

Detroit

Novi, MI
Tel: 248-848-4000

Houston, TX

Tel: 281-894-5983

Indianapolis

Noblesville, IN
Tel: 317-773-8323
Fax: 317-773-5453
Tel: 317-536-2380

Los Angeles

Mission Viejo, CA
Tel: 949-462-9523
Fax: 949-462-9608
Tel: 951-273-7800

Raleigh, NC

Tel: 919-844-7510

New York, NY

Tel: 631-435-6000

San Jose, CA

Tel: 408-735-9110
Tel: 408-436-4270

Canada - Toronto

Tel: 905-695-1980
Fax: 905-695-2078

ASIA/PACIFIC

Australia - Sydney
Tel: 61-2-9868-6733

China - Beijing
Tel: 86-10-8569-7000

China - Chengdu
Tel: 86-28-8665-5511

China - Chongqing
Tel: 86-23-8980-9588

China - Dongguan
Tel: 86-769-8702-9880

China - Guangzhou
Tel: 86-20-8755-8029

China - Hangzhou
Tel: 86-571-8792-8115

China - Hong Kong SAR
Tel: 852-2943-5100

China - Nanjing
Tel: 86-25-8473-2460

China - Qingdao
Tel: 86-532-8502-7355

China - Shanghai
Tel: 86-21-3326-8000

China - Shenyang
Tel: 86-24-2334-2829

China - Shenzhen
Tel: 86-755-8864-2200

China - Suzhou
Tel: 86-186-6233-1526

China - Wuhan
Tel: 86-27-5980-5300

China - Xian
Tel: 86-29-8833-7252

China - Xiamen
Tel: 86-592-2388138

China - Zhuhai
Tel: 86-756-3210040

ASIA/PACIFIC

India - Bangalore
Tel: 91-80-3090-4444

India - New Delhi
Tel: 91-11-4160-8631

India - Pune
Tel: 91-20-4121-0141

Japan - Osaka
Tel: 81-6-6152-7160

Japan - Tokyo
Tel: 81-3-6880-3770

Korea - Daegu
Tel: 82-53-744-4301

Korea - Seoul
Tel: 82-2-554-7200

Malaysia - Kuala Lumpur
Tel: 60-3-7651-7906

Malaysia - Penang
Tel: 60-4-227-8870

Philippines - Manila
Tel: 63-2-634-9065

Singapore
Tel: 65-6334-8870

Taiwan - Hsin Chu
Tel: 886-3-577-8366

Taiwan - Kaohsiung
Tel: 886-7-213-7830

Taiwan - Taipei
Tel: 886-2-2508-8600

Thailand - Bangkok
Tel: 66-2-694-1351

Vietnam - Ho Chi Minh
Tel: 84-28-5448-2100

EUROPE

Austria - Wels
Tel: 43-7242-2244-39
Fax: 43-7242-2244-393

Denmark - Copenhagen
Tel: 45-4450-2828
Fax: 45-4485-2829

Finland - Espoo
Tel: 358-9-4520-820

France - Paris
Tel: 33-1-69-53-63-20
Fax: 33-1-69-30-90-79

Germany - Garching
Tel: 49-8931-9700

Germany - Haan
Tel: 49-2129-3766400

Germany - Heilbronn
Tel: 49-7131-67-3636

Germany - Karlsruhe
Tel: 49-721-625370

Germany - Munich
Tel: 49-89-627-144-0
Fax: 49-89-627-144-44

Germany - Rosenheim
Tel: 49-8031-354-560

Israel - Ra'anana
Tel: 972-9-744-7705

Italy - Milan
Tel: 39-0331-742611
Fax: 39-0331-466781

Italy - Padova
Tel: 39-049-7625286

Netherlands - Drunen
Tel: 31-416-690399
Fax: 31-416-690340

Norway - Trondheim
Tel: 47-7289-7561

Poland - Warsaw
Tel: 48-22-3325737

Romania - Bucharest
Tel: 40-21-407-87-50

Spain - Madrid
Tel: 34-91-708-08-90
Fax: 34-91-708-08-91

Sweden - Gothenberg
Tel: 46-31-704-60-40

Sweden - Stockholm
Tel: 46-8-5090-4654

UK - Wokingham
Tel: 44-118-921-5800
Fax: 44-118-921-5820