

Data sheet | Item number: 282-135

2-conductor disconnect/test terminal block; for DIN-rail 35 x 15 and 35 x 7.5;
6 mm²; CAGE CLAMP®; 6,00 mm²; gray

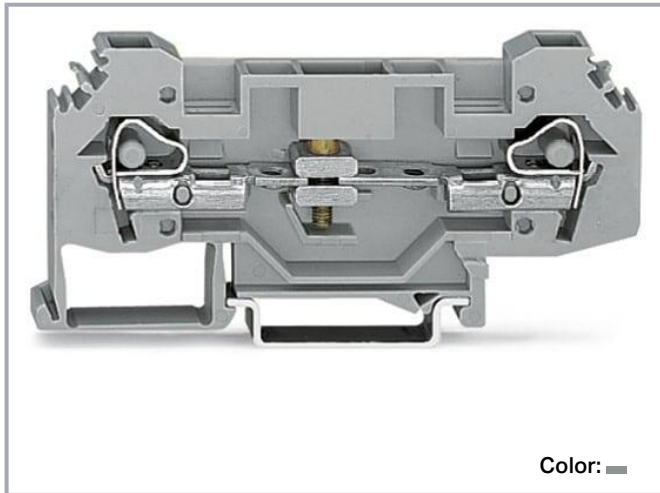

www.wago.com/282-135



Color: 

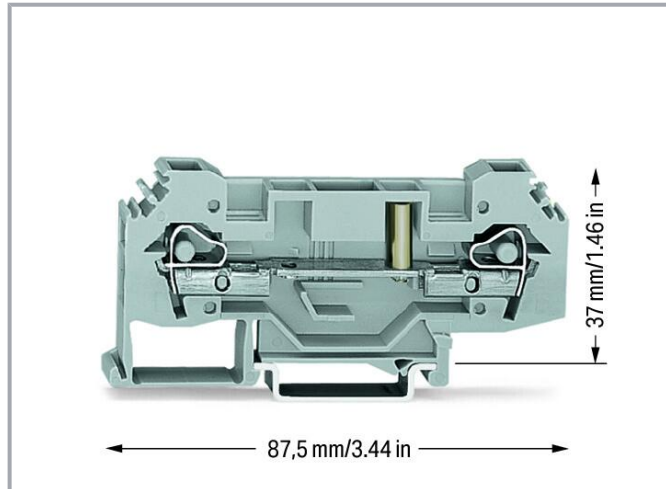

Data

Electrical data

Ratings per IEC/EN

| | |
|-------------------------------|---|
| Nominal voltage (III/3) | 400 V |
| Rated impulse voltage (III/3) | 6 kV |
| Rated current | 41 A |
| Legend (ratings) | (III / 3) ≙ Overvoltage category III / Pollution degree 3 |

Power loss

| | |
|--|---------|
| Power loss, per pole (potential) | 1.311 W |
| Rated current I_N for specified power loss | 41 A |
| Resistance value for specified, current-dependent power loss | 0.001 Ω |

Connection data

| | |
|----------------------------|---|
| Connection points | 2 |
| Total number of potentials | 1 |
| Number of levels | 1 |

Subject to changes. Please also observe the further product documentation!

WAGO GmbH & Co. KG
Hansastr. 27
32423 Minden
Phone: +49571 887-0 | Fax: +49571 887-169
Email: info.de@wago.com | Web: www.wago.com

Do you have any questions about our products?
We are always happy to take your call at +49 (571) 887-44222.



Connection 1

| | |
|---------------------------------|---|
| Connection technology | CAGE CLAMP® |
| Actuation type | Operating tool |
| Connectable conductor materials | Copper |
| Solid conductor | 0.2 ... 6 mm ² / 24 ... 10 AWG |
| Fine-stranded conductor | 0.2 ... 6 mm ² / 24 ... 10 AWG |
| Strip length | 12 ... 13 mm / 0.47 ... 0.51 inches |
| Wiring direction | Side-entry wiring |

Physical data

| | |
|-----------------------------------|------------------------|
| Width | 8 mm / 0.315 inches |
| Height | 87.5 mm / 3.445 inches |
| Depth from upper-edge of DIN-rail | 37 mm / 1.457 inches |

Mechanical Data

| | |
|---------------|-----------------|
| Design | horizontal type |
| Mounting type | DIN-35 rail |
| Marking level | Side marking |

Material Data

| | |
|-----------------------------|--|
| Note (material data) | Information on material specifications can be found here |
| Color | gray |
| Material group | I |
| Insulation material | Polyamide (PA66) |
| Flammability class per UL94 | V0 |
| Fire load | 0.303 MJ |
| Weight | 20.9 g |

Environmental requirements

| | |
|----------------------------------|-----------------|
| Processing temperature | -35 ... +85 °C |
| Continuous operating temperature | -60 ... +105 °C |

Commercial data

| | |
|---------------|----------------------------------|
| Product Group | 1 (Rail Mounted Terminal Blocks) |
|---------------|----------------------------------|

Subject to changes. Please also observe the further product documentation!



| | |
|-----------------------|---------------|
| eCl@ss 10.0 | 27-14-11-26 |
| eCl@ss 9.0 | 27-14-11-26 |
| ETIM 8.0 | EC000902 |
| ETIM 7.0 | EC000902 |
| PU (SPU) | 25 pcs |
| Packaging type | box |
| Country of origin | CN |
| GTIN | 4050821397113 |
| Customs tariff number | 85365080900 |

Environmental Product Compliance

| | |
|---|--------------------------------------|
| CAS-No. | 7439-92-1 |
| REACH Candidate List Substance | Lead |
| RoHS Compliance Status | Compliant,With Exemption |
| RoHS Exemption | 6(c) 7(a) 7(c)-I 7(c)-II |
| SCIP notification number (Austria) | 3e9e1e88-5c94-4ed9-9972-7249f232f2cf |
| SCIP notification number (Belgium) | 963e2c3a-bf15-4ce1-89ec-5cb4046fc755 |
| SCIP notification number (Bulgaria) | 5b1c12c4-5eca-4293-be0e-bafa8db23239 |
| SCIP notification number (Czech Republic) | b81dda48-1cae-4eea-9ca2-9621a496c34b |
| SCIP notification number (Denmark) | 2dad3ff6-82f2-4477-bb5b-c360acece6fa |
| SCIP notification number (Finland) | c0c8f938-f76b-411e-a8b0-2e1878ba3f25 |
| SCIP notification number (France) | 44d44d15-e8db-4d07-9e89-d0b288c88e63 |
| SCIP notification number (Germany) | 9c615d24-0234-433b-ad0f-f40bb19c1a8d |
| SCIP notification number (Hungary) | 2571880d-1fc7-4f06-8de8-a3701e4f12e6 |
| SCIP notification number (Italy) | 670fe476-a3e0-49be-97a7-3f6326a85311 |
| SCIP notification number (Netherlands) | 25f20aad-b160-4247-b6c7-400be7f7b75b |
| SCIP notification number (Poland) | fbfb8cc8-91ba-4500-b420-5bbd37eac6eb |
| SCIP notification number (Romania) | 77bc640b-2012-415d-bce2-59849d46e695 |
| SCIP notification number (Sweden) | 2da1d1d0-aea0-4dad-80b0-162779f3506f |

Approvals / Certificates

General approvals

| Logo | Approval | Additional Approval Text | Certificate name |
|------|----------|--------------------------|------------------|
| | CCA | EN 60947 | NTR NL |

Subject to changes. Please also observe the further product documentation!

WAGO GmbH & Co. KG
 Hansastr. 27
 32423 Minden
 Phone: +49571 887-0 | Fax: +49571 887-169
 Email: info.de@wago.com | Web: www.wago.com

Do you have any questions about our products?
 We are always happy to take your call at +49 (571) 887-44222.



DEKRA Certification B.V.

7894



KEMA/KEUR



EN 60947

DEKRA Certification B.V.



71-

120778

Declarations of conformity and manufacturer's declarations



| Logo | Approval | Additional Approval Text | Certificate name |
|--|--|--------------------------|------------------|
|  | EU-Declaration of Conformity WAGO GmbH & Co. KG | - | - |
|  | UK-Declaration of Conformity WAGO GmbH & Co. KG | - | - |

Approvals for marine applications

| Logo | Approval | Additional Approval Text | Certificate name |
|--|--|--------------------------|--------------------------|
|  | ABS American Bureau of Shipping | EN 60947 | 20- HG1941090- PDA |
|  | DNV GL Det Norske Veritas, Germanischer Lloyd | - | TAE00001V2 |

Required accessories

End plate

| End plate | | |
|--|---|--|
|  | Item no.: 282-314 End and intermediate plate; 4 mm thick; gray | www.wago.com/282-314 |
|  | Item no.: 282-315 End and intermediate plate; 4 mm thick; orange | www.wago.com/282-315 |

Subject to changes. Please also observe the further product documentation!

WAGO GmbH & Co. KG

Hansastr. 27

32423 Minden

Phone: +49571 887-0 | Fax: +49571 887-169

Email: info.de@wago.com | Web: www.wago.com

Do you have any questions about our products?

We are always happy to take your call at +49 (571) 887-44222.

Optional accessories

Tool

Operating tool



Item no.: 210-721

Operating tool; Blade: 5.5 x 0.8 mm; with a partially insulated shaft; multicoloured

www.wago.com/210-721

Carrier rail

Mounting accessories



Item no.: 210-197

Steel carrier rail; 35 x 15 mm; 1.5 mm thick; 2 m long; slotted; similar to EN 60715; silver-colored

www.wago.com/210-197



Item no.: 210-198

Copper carrier rail; 35 x 15 mm; 2.3 mm thick; 2 m long; unslotted; according to EN 60715; copper-colored

www.wago.com/210-198



Item no.: 210-504

Steel carrier rail; 35 x 7.5 mm; 1 mm thick; 2 m long; slotted; galvanized; according to EN 60715; silver-colored

www.wago.com/210-504



Item no.: 210-505

Steel carrier rail; 35 x 7.5 mm; 1 mm thick; 2 m long; unslotted; galvanized; according to EN 60715; silver-colored

www.wago.com/210-505

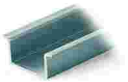

Item no.: 210-506

Steel carrier rail; 35 x 15 mm; 1.5 mm thick; 2 m long; unslotted; galvanized; similar to EN 60715; silver-colored

www.wago.com/210-506



Item no.: 210-508

Steel carrier rail; 35 x 15 mm; 1.5 mm thick; 2 m long; slotted; galvanized; similar to EN 60715; silver-colored

www.wago.com/210-508



Item no.: 210-113

Steel carrier rail; 35 x 7.5 mm; 1 mm thick; 2 m long; unslotted; according to EN 60715; silver-colored

www.wago.com/210-113



Item no.: 210-118

Steel carrier rail; 35 x 15 mm; 2.3 mm thick; 2 m long; unslotted; according to EN 60715; silver-colored

www.wago.com/210-118



Item no.: 210-112

Steel carrier rail; 35 x 7.5 mm; 1 mm thick; 2 m long; slotted; according to EN 60715; "Hole width 25 mm; silver-colored

www.wago.com/210-112



Item no.: 210-114

Steel carrier rail; 35 x 15 mm; 1.5 mm thick; 2 m long; unslotted; similar to EN 60715; silver-colored

www.wago.com/210-114



Item no.: 210-115

Steel carrier rail; 35 x 7.5 mm; 1 mm thick; 2 m long; slotted; according to EN 60715; "Hole width 18 mm; silver-colored

www.wago.com/210-115



Item no.: 210-196

Aluminum carrier rail; 35 x 8.2 mm; 1.6 mm thick; 2 m long; unslotted; similar to EN 60715; silver-colored

www.wago.com/210-196

Jumpers

Subject to changes. Please also observe the further product documentation!

WAGO GmbH & Co. KG

Hansastr. 27















32423 Minden

Phone: +49571 887-0 | Fax: +49571 887-169











Email: info.de@wago.com | Web: www.wago.com

Do you have any questions about our products?











We are always happy to take your call at +49 (571) 887-44222.

| Jumper | | |
|--|--|--|
|  | Item no.: 282-409 Jumper; insulated; gray | www.wago.com/282-409 |
|  | Item no.: 282-424 Jumper; insulated; orange | www.wago.com/282-424 |
|  | Item no.: 282-402 Jumper; insulated; gray | www.wago.com/282-402 |
|  | Item no.: 282-422 Jumper; insulated; yellow-green | www.wago.com/282-422 |
|  | Item no.: 709-110 Wire commoning chain; 2.5 mm ² ; insulated; black | www.wago.com/709-110 |
|  | Item no.: 709-112 Wire commoning chain; 2.5 mm ² ; insulated; black | www.wago.com/709-112 |
|  | Item no.: 709-111 Wire commoning chain; 2.5 mm ² ; insulated; black | www.wago.com/709-111 |
| Coding | | |
| Locking system | | |
|  | Item no.: 282-137 Lock-out; prevents reclosing of slide link; snap-in type; orange | www.wago.com/282-137 |
| Ferrule | | |
| Ferrule | | |
|  | Item no.: 216-263 Ferrule; Sleeve for 1 mm ² / AWG 18; insulated; electro-tin plated; electrolytic copper; gastight crimped; acc. to DIN 46228, Part 4/09.90; red | www.wago.com/216-263 |
|  | Item no.: 216-266 Ferrule; Sleeve for 2.5 mm ² / AWG 14; insulated; electro-tin plated; electrolytic copper; gastight crimped; acc. to DIN 46228, Part 4/09.90; blue | www.wago.com/216-266 |
|  | Item no.: 216-264 Ferrule; Sleeve for 1.5 mm ² / AWG 16; insulated; electro-tin plated; electrolytic copper; gastight crimped; acc. to DIN 46228, Part 4/09.90; black | www.wago.com/216-264 |
|  | Item no.: 216-262 Ferrule; Sleeve for 0.75 mm ² / 18 AWG; insulated; electro-tin plated; electrolytic copper; gastight crimped; acc. to DIN 46228, Part 4/09.90; gray | www.wago.com/216-262 |
|  | Item no.: 216-267 Ferrule; Sleeve for 4 mm ² / AWG 12; insulated; electro-tin plated; electrolytic copper; gastight crimped; acc. to DIN 46228, Part 4/09.90; gray | www.wago.com/216-267 |
| Testing and measuring | | |
| Testing accessories | | |
|  | Item no.: 209-170 Test plug adapter; 8.3 mm wide; for 4 mm Ø test plugs; suitable for 1.5 mm ² - 10 mm ² tbs; gray | www.wago.com/209-170 |

Subject to changes. Please also observe the further product documentation!

| | | |
|--|--|--|
|  | Item no.: 709-310 B-type test plug module; modular; suitable for all WAGO 282 Series rail-mounted terminal blocks with jumper slots; 6,00 mm ² ; gray | www.wago.com/709-310 |
|  | Item no.: 709-311 B-type spacer module; modular; e.g., for bridging commoned terminal blocks; gray | www.wago.com/709-311 |
| Mounting | | |
| Cover carrier | | |
|  | Item no.: 709-167 Cover carrier; Type 1; incl. fixing/retaining screws and knurled nut; suitable for 279 to 282 and 880 Series rail-mounted terminal blocks; suitable for 264 Series miniature rail-mounted terminal blocks; suitable for 270 Series sensor and actuator terminal blocks; gray | www.wago.com/709-167 |
| Cover | | |
|  | Item no.: 709-153 Cover; Type 1; suitable for cover carrier, type 1; 1 m long; transparent | www.wago.com/709-153 |
| Mounting accessories | | |
|  | Item no.: 209-106 Mounting carrier; for isolated mounting on DIN 35 rails; gray | www.wago.com/209-106 |
|  | Item no.: 249-116 Screwless end stop; 6 mm wide; for DIN-rail 35 x 15 and 35 x 7.5; gray | www.wago.com/249-116 |
| Protective warning marker | | |
| Cover | | |
|  | Item no.: 282-405 Protective warning marker; for 5 terminal blocks; with high-voltage symbol, black; yellow | www.wago.com/282-405 |
| Marking accessories | | |
| Marker | | |
|  | Item no.: 2009-115/000-002 WMB-Inline; for Smart Printer; 1500 pieces on roll; stretchable 5 - 5.2 mm; plain; snap-on type; yellow | www.wago.com/2009-115/000-002 |
|  | Item no.: 2009-115/000-007 WMB-Inline; for Smart Printer; 1500 pieces on roll; stretchable 5 - 5.2 mm; plain; snap-on type; gray | www.wago.com/2009-115/000-007 |
|  | Item no.: 2009-115/000-017 WMB-Inline; for Smart Printer; 1500 pieces on roll; stretchable 5 - 5.2 mm; plain; snap-on type; light green | www.wago.com/2009-115/000-017 |
|  | Item no.: 2009-115/000-023 WMB-Inline; for Smart Printer; 1500 pieces on roll; stretchable 5 - 5.2 mm; plain; snap-on type; green | www.wago.com/2009-115/000-023 |

Subject to changes. Please also observe the further product documentation!

| | | |
|--|--|--|
|  | Item no.: 2009-115/000-024 WMB-Inline; for Smart Printer; 1500 pieces on roll; stretchable 5 - 5.2 mm; plain; snap-on type; violet | www.wago.com/2009-115/000-024 |
|  | Item no.: 2009-115 WMB-Inline; for Smart Printer; 1500 pieces on roll; stretchable 5 - 5.2 mm; plain; snap-on type; white | www.wago.com/2009-115 |
|  | Item no.: 793-5501/000-007 WMB marking card; as card; for terminal block width 5 - 17.5 mm; stretchable 5 - 5.2 mm; plain; snap-on type; gray | www.wago.com/793-5501/000-007 |
|  | Item no.: 793-5501/000-012 WMB marking card; as card; for terminal block width 5 - 17.5 mm; stretchable 5 - 5.2 mm; plain; snap-on type; orange | www.wago.com/793-5501/000-012 |
|  | Item no.: 793-5501/000-014 WMB marking card; as card; for terminal block width 5 - 17.5 mm; stretchable 5 - 5.2 mm; plain; snap-on type; brown | www.wago.com/793-5501/000-014 |
|  | Item no.: 793-5501/000-017 WMB marking card; as card; for terminal block width 5 - 17.5 mm; stretchable 5 - 5.2 mm; plain; snap-on type; light green | www.wago.com/793-5501/000-017 |
|  | Item no.: 793-5501/000-023 WMB marking card; as card; for terminal block width 5 - 17.5 mm; stretchable 5 - 5.2 mm; plain; snap-on type; green | www.wago.com/793-5501/000-023 |
|  | Item no.: 793-5501/000-024 WMB marking card; as card; for terminal block width 5 - 17.5 mm; stretchable 5 - 5.2 mm; plain; snap-on type; violet | www.wago.com/793-5501/000-024 |
|  | Item no.: 793-501/000-002 WMB marking card; as card; not stretchable; plain; snap-on type; yellow | www.wago.com/793-501/000-002 |
|  | Item no.: 793-501/000-007 WMB marking card; as card; not stretchable; plain; snap-on type; gray | www.wago.com/793-501/000-007 |
|  | Item no.: 793-501/000-017 WMB marking card; as card; not stretchable; plain; snap-on type; light green | www.wago.com/793-501/000-017 |

Subject to changes. Please also observe the further product documentation!



Item no.: 793-501/000-012
WMB marking card; as card; not stretchable; plain; snap-on type; orange

www.wago.com/793-501/000-012



Item no.: 793-501/000-023
WMB marking card; as card; not stretchable; plain; snap-on type; green

www.wago.com/793-501/000-023



Item no.: 793-501/000-006
WMB marking card; as card; not stretchable; plain; snap-on type; blue

www.wago.com/793-501/000-006



Item no.: 793-501/000-005
WMB marking card; as card; not stretchable; plain; snap-on type; red

www.wago.com/793-501/000-005



Item no.: 793-501
WMB marking card; as card; not stretchable; plain; snap-on type; white

www.wago.com/793-501



Item no.: 793-501/000-024
WMB marking card; as card; not stretchable; plain; snap-on type; violet

www.wago.com/793-501/000-024



Item no.: 793-5501/000-005
WMB marking card; as card; for terminal block width 5 - 17.5 mm; stretchable 5 - 5.2 mm; plain; snap-on type; red

www.wago.com/793-5501/000-005



Item no.: 793-5501/000-002
WMB marking card; as card; for terminal block width 5 - 17.5 mm; stretchable 5 - 5.2 mm; plain; snap-on type; yellow

www.wago.com/793-5501/000-002



Item no.: 793-5501/000-006
WMB marking card; as card; for terminal block width 5 - 17.5 mm; stretchable 5 - 5.2 mm; plain; snap-on type; blue

www.wago.com/793-5501/000-006



Item no.: 793-5501
WMB marking card; as card; for terminal block width 5 - 17.5 mm; stretchable 5 - 5.2 mm; plain; snap-on type; white

www.wago.com/793-5501



Item no.: 2009-115/000-012
WMB-Inline; for Smart Printer; 1500 pieces on roll; stretchable 5 - 5.2 mm; plain; snap-on type; orange

www.wago.com/2009-115/000-012

Subject to changes. Please also observe the further product documentation!



Item no.: 2009-115/000-006

WMB-Inline; for Smart Printer; 1500 pieces on roll; stretchable 5 - 5.2 mm; plain; snap-on type; blue

www.wago.com/2009-115/000-006

Group marker carrier



Item no.: 209-144

Group marker carrier; gray

www.wago.com/209-144



Item no.: 209-143

Group marker carrier; gray

www.wago.com/209-143



Item no.: 249-105

Group marker carrier; gray

www.wago.com/249-105

Downloads

Documentation

Bid Text

| | | | |
|------------------------|-------------|----------------|----------|
| 282-135 X81 - Datei | 2019 Feb 19 | xml 3.2 kB | Download |
| 282-135 doc - Datei | 2017 Jun 12 | doc 24.6 kB | Download |

Additional Information

| | | | |
|---|--|---------------|----------|
| Technical Section Technical explanations | | pdf 2.2 MB | Download |
|---|--|---------------|----------|

CAD/CAE-Data

CAD data

| | | | |
|----------------------|--|-----|----------|
| 2D/3D Models 282-135 | | URL | Download |
|----------------------|--|-----|----------|

CAE data

| | | | |
|---------------------------|--|-----|----------|
| EPLAN Data Portal 282-135 | | URL | Download |
|---------------------------|--|-----|----------|

| | | | |
|------------------------|--|-----|----------|
| WSCAD Universe 282-135 | | URL | Download |
|------------------------|--|-----|----------|

| | | | |
|----------------------|--|-----|----------|
| ZUKEN Portal 282-135 | | URL | Download |
|----------------------|--|-----|----------|

Subject to changes. Please also observe the further product documentation!

WAGO GmbH & Co. KG
 Hansastr. 27
 32423 Minden
 Phone: +49571 887-0 | Fax: +49571 887-169
 Email: info.de@wago.com | Web: www.wago.com

Do you have any questions about our products?
 We are always happy to take your call at +49 (571) 887-44222.

Environmental Product Compliance

Compliance Search

Environmental Product Compliance 282-135

URL

Download

2-conductor disconnect/test terminal block; for DIN-rail 35 x 15 and 35 x 7.5; 6 mm²; CAGE CLAMP®; 6,00 mm²; gray

Installation Notes

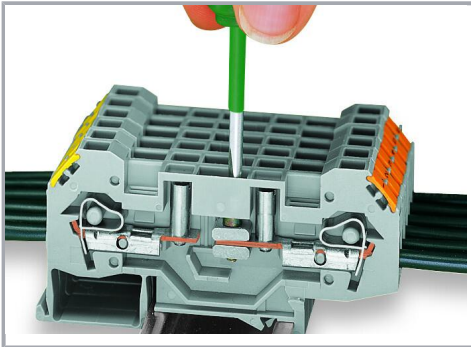

Shifting the disconnect slide link.

Subject to changes. Please also observe the further product documentation!