

LTM4623

Tiny 2A DC/DC Inverting Buck-Boost µModule Regulator

DESCRIPTION

Demonstration circuit 2721A-A features the [LTM®4623](#) µModule® regulator, a tiny high performance high efficiency step-down regulator configured as an inverting buck-boost regulator. The DC2721A-A has an operating input voltage range of 4V to 15V and is able to provide an output current of up to 2A. The output voltage can be programmed between -0.6V and -5.5V. The LTM4623 is a complete DC/DC point of load regulator in a thermally

enhanced 6.25mm × 6.25mm × 1.82mm LGA package requiring only a few input and output capacitors. The LTM4623 data sheet must be read in conjunction with this demo manual for working on or modifying demo circuit 2721A-A.

[Design files for this circuit board are available.](#)

All registered trademarks and trademarks are the property of their respective owners.

PERFORMANCE SUMMARY Specifications are at T_A = 25°C

PARAMETER	CONDITIONS/NOTES	VALUE
Input Voltage Range		4V to 15V
Output Voltage V _{OUT}	Jumper Selectable	-0.9V _{DC} , -5.2V _{DC}
Maximum Continuous Output Current	Derating is Necessary for Certain Operating Conditions. See Data Sheet for Details	2A _{DC}
Default Operating Frequency		1MHz
Efficiency	V _{IN} = 12V, V _{OUT} = -2.5V, I _{OUT} = 2A	84% See Figure 2

BOARD PHOTO

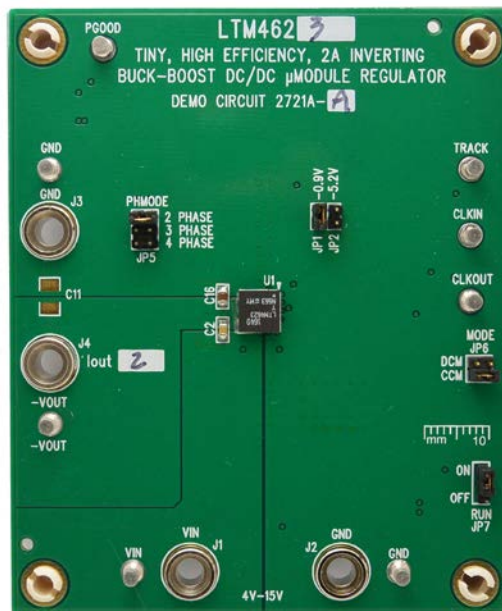

QUICK START PROCEDURE

Demonstration circuit 2721A-A is an easy way to evaluate the performance of the LTM4623. Please refer to Figure 1 for test setup connections and follow the procedure below.

1. With power off, place the jumpers in the following positions for a typical $-0.9V_{OUT}$ application:

JP7	JP5	JP1
RUN	MODE	V_{OUT} Select
ON	CCM	-0.9V

2. Before connecting input supply, load and meters, pre-set the input voltage supply to be between 4V to 15V. Preset the load current to 0A.
3. With power off, connect the load, input voltage supply and meters as shown in Figure 1.
4. Turn on input power supply. The output voltage meter should display the selected output voltage $\pm 2\%$.
5. Once the proper output voltage is established, adjust the load current within the 0A to 2A range and observe the load regulation, efficiency, and other parameters. Output voltage ripple should be measured across C12 with a BNC cable terminated into 50Ω and an oscilloscope.
6. To observe increased light load efficiency place the mode pin jumper (JP5) in the DCM position.
7. Level shifting circuits are provided for PGOOD, CLKIN and RUN signals. The CLKIN turret E6 can be connected to a ground referenced clock with amplitude up to 3.3V for optional external clock synchronization. The PGOOD turret E8 provides a ground referenced 3.3V PGOOD signal.
8. Note that CLKOUT and TRACK signals are not level shifted, these signals are referenced to $-V_{OUT}$. If ground referenced CLKOUT output and TRACK input signals are desired, external level shifting circuits for these pins are necessary.

QUICK START PROCEDURE

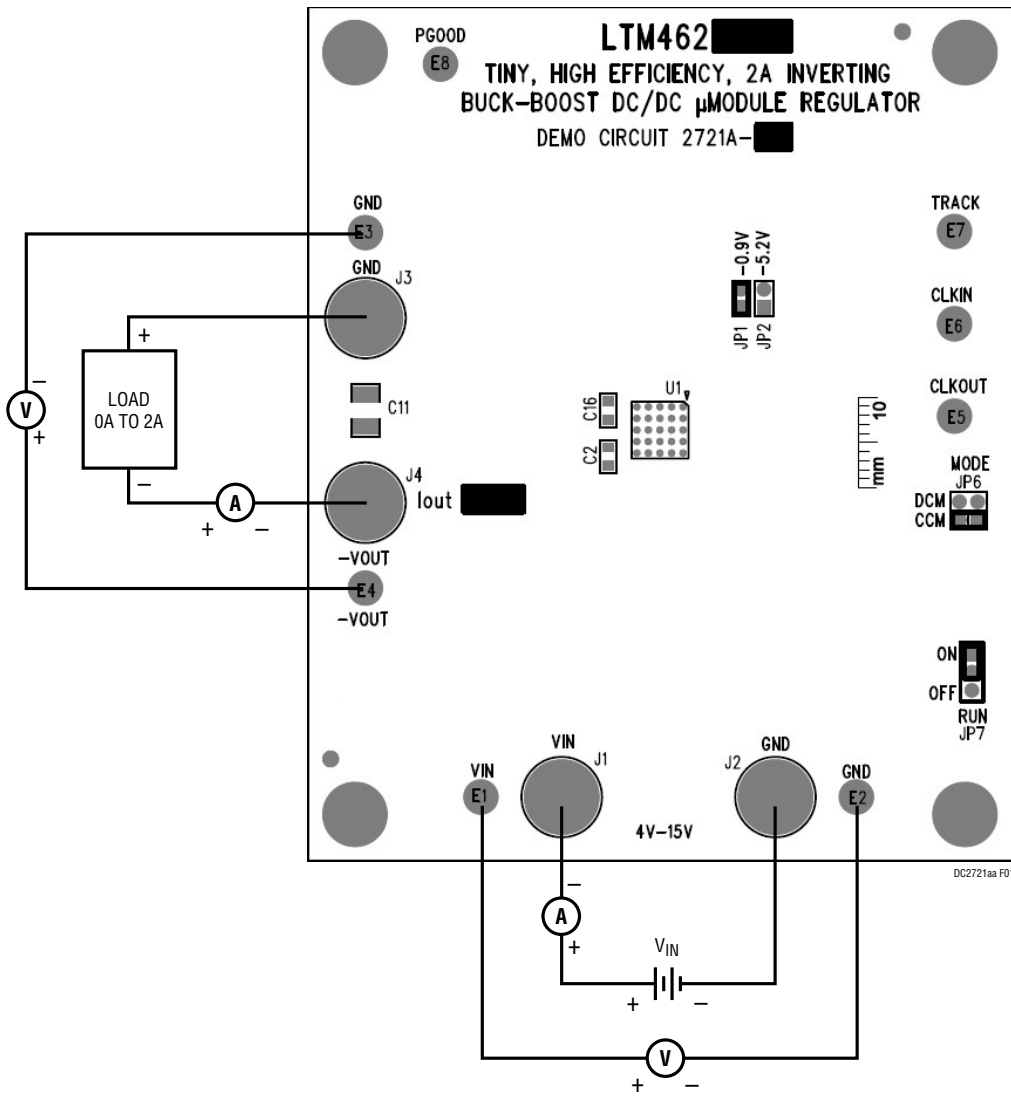

Figure 1. Test Setup

QUICK START PROCEDURE

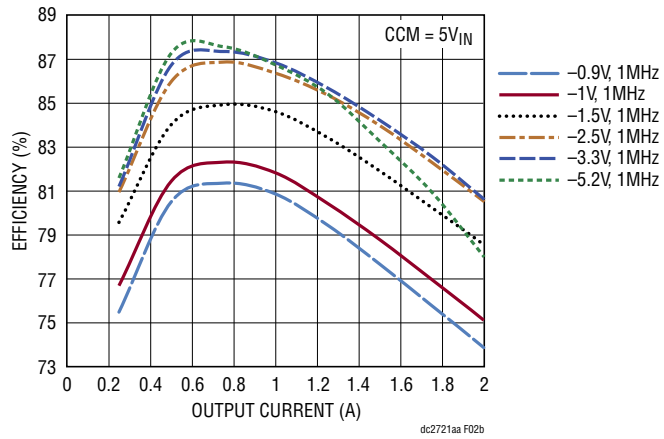
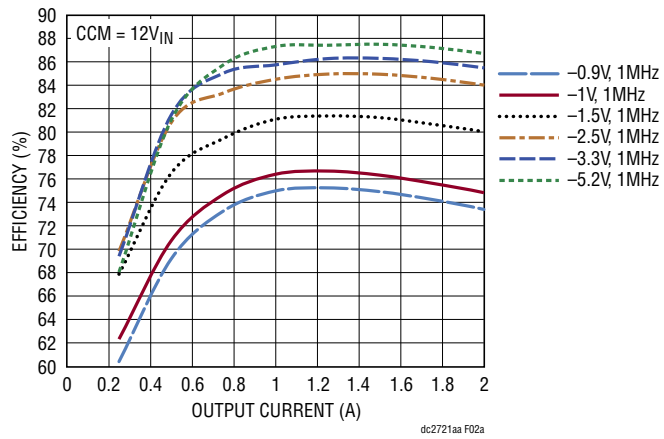
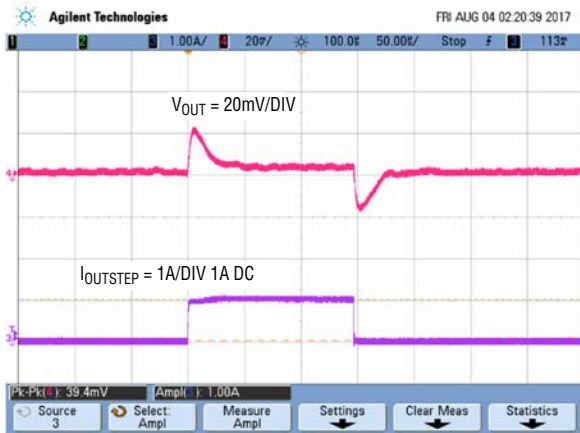

Figure 2. Measured Supply Efficiency at $12V_{IN}$ and $5V_{IN}$

QUICK START PROCEDURE



V_{IN} (V)	V_{OUT} (V)	C_{OUT}
12	-0.9	$1 \times 100\mu\text{F}/6.3\text{V} +$ $1 \times 22\mu\text{F}/6.3\text{V} +$ $1 \times 47\mu\text{F}/6.3\text{V}$

Figure 3. Measured Load Transient Response (1A to 2A Load Step)

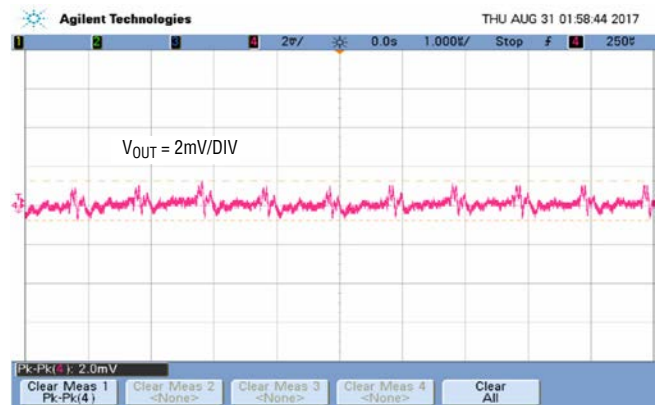

V_{IN} (V)	V_{OUT} (V)	I_{OUT} (A)	C_{OUT}
12	-0.9	2	$1 \times 100\mu\text{F}/6.3\text{V} +$ $1 \times 22\mu\text{F}/6.3\text{V} +$ $1 \times 47\mu\text{F}/6.3\text{V}$

Figure 4. Measured V_{OUT} Ripple

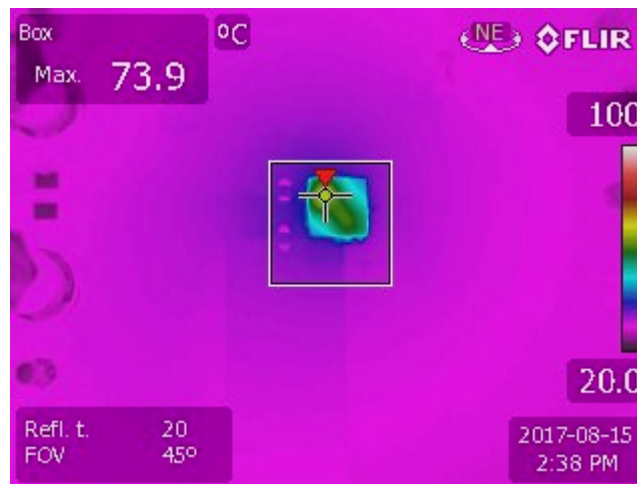

V_{IN} (V)	V_{OUT} (V)	I_{LOAD} (A)	f_{SW} (MHz)	$T_{AMBIENT}$ (C)	FORCED AIRFLOW (LFM)
12	-5.2	2	1	25	0

Figure 5. Measured Case Temperature

DEMO MANUAL

DC2721A-A

PARTS LIST

ITEM	QTY	REFERENCE	PART DESCRIPTION	MANUFACTURER/PART NUMBER
Required Circuit Components				
1	1	C1	CAP., 2.2uF, X5R, 10V, 10%, 0603	MURATA, GRM188R61A225KE34D
2	1	C2	CAP., 10uF, X5R, 25V, 10%, 0805	AVX, 08053D106KAT2A
3	1	C12	CAP., 100uF, X5R, 6.3V, 20%,1210	MURATA, GRM32ER60J107ME20L
4	1	C16	CAP., 22uF, X5R, 6.3V, 20%, 0805	TDK, C2012X5R0J226M125AC
5	1	C20	CAP., 47uF, X5R, 6.3V, 20%,1206	TDK, C3216X5R0J476M160AC
6	1	R4	RES., 121k, 1/10W, 1%, 0603	VISHAY, CRCW0603121KFKEA
7	1	U1	I.C., STEP-DOWN μ MODULE REGULATOR, LGA-25	ANALOG DEVICES, LTM4623EV#PBF
Additional Demo Board Circuit Components				
1	0	C3,C5 (OPT)	CAP., OPTION, 1206	OPT
2	0	C7,C19 (OPT)	CAP., OPTION, 0603	OPT
3	1	C8	CAP., 100pF, X7R, 50V, 10%, 0603	AVX, 06035C101KAT2A
4	2	C9,C15	CAP., 0.1uF, X5R, 25V, 10%, 0603	AVX, 06033D104KAT2A
5	1	C10	CAP., 22uF, TANT. POLY., 25V, 20%, 7343	PANSONIC, 25TQC22MV
6	0	C11,C14 (OPT)	CAP., OPTION, 1210	OPT
7	1	C13	CAP., 22uF, X5R, 16V, 10%, 1206	MURATA, GRM31CR61C226ME15L
7	1	C23	CAP., 2.2uF, X5R, 10V, 10%,1206	AVX, 1206ZD225KAT2A
7	1	C24	CAP., 1uF, X7R, 25V, 10%,1206	AVX, 12063C105KAT2A
8	0	C17 (OPT)	CAP., OPTION, 7343	OPT
9	2	C21,C22	CAP., 0.01uF, X7R, 16V, 10%, 0603	AVX, 0603YC103KAT2A
10	1	D1	DIODE, ZENER, SOD323	CENTRAL SEMI., CMDZ5230B-L
11	1	D2	DIODE, SCHOTTKY, SOD323	CENTRAL SEMI., CMDSH2-3
12	1	D3	DIODE, SCHOTTKY, SOD323	CENTRAL SEMI., CMDSH2-4L
13	1	Q1	XSTR., MOSFET, N-CHAN., 20V, TSOP-6	VISHAY, SI3900DV-T1-GE3
14	1	Q2	XSTR., PNP 40V 0.2A SOT-23	ON SEMI., MMBT3906LT1G
15	0	R1,R2,R12 (OPT)	CAP., OPTION, 0603	OPT
16	1	R5	RES., 7.87k, 1/10W, 1%, 0603	VISHAY, CRCW06037K87FKEA
17	5	R8,R18,R19,R20,R21	RES., 100k, 1/10W, 1%, 0603	VISHAY, CRCW0603100KFKEA
18	1	R9	RES., 15k, 1/10W, 1%, 0603	VISHAY, CRCW060315K0FKEA
19	1	R10	RES., 10k, 1/10W, 1%, 0603	VISHAY, CRCW060310K0FKEA
20	1	R11	RES., 10 OHMS, 1/10W, 1%, 0603	VISHAY, CRCW060310R0FKEA
21	2	R13,R23	RES., 0 OHM, 1/10W, 0603	VISHAY, CRCW06030000Z0EA
22	2	R17,R22	RES., 1k, 1/10W, 1%, 0603	VISHAY, CRCW06031K0FKEA
23	1	U2	IC, REG LDO 3.3V 0.1A DFN8	ANALOG DEVICES, LT3060EDC-3.3#TRPBF
Hardware: For Demo Board Only				
1	8	E1,E2,E3,E4,E5,E6,E7,E8	TEST POINT, TURRET, 0.094", MTG. HOLE	MILL MAX 2501-2-00-80-00-00-07-0
2	2	JP1,JP2	CONN., HEADER, 1X2, 2mm	WURTH ELEKTRONIK, 62000211121
3	1	JP5	CONN., HEADER, 2X2, 2mm	WURTH ELEKTRONIK, 62000421121
4	1	JP7	CONN., HEADER, 1X3, 2mm	WURTH ELEKTRONIK, 62000311121
5	4	XJP1,XJP5,XJP6,XJP7	CONN., SHUNT, FEMALE, 2 POS, 2mm	WURTH ELEKTRONIK, 60800213421
6	4	J1,J2,J3,J4	CONN., BANANA JACK, FEMALE, TH, NON-INSULATED, SWAGE, 0.218"	KEYSTONE, 575-4
7	4	MH1,MH2,MH3,MH4	STANDOFF, NYLON, SNAP-ON , 0.375"	KEYSTONE, 8832

Rev.A

SCHEMATIC DIAGRAM

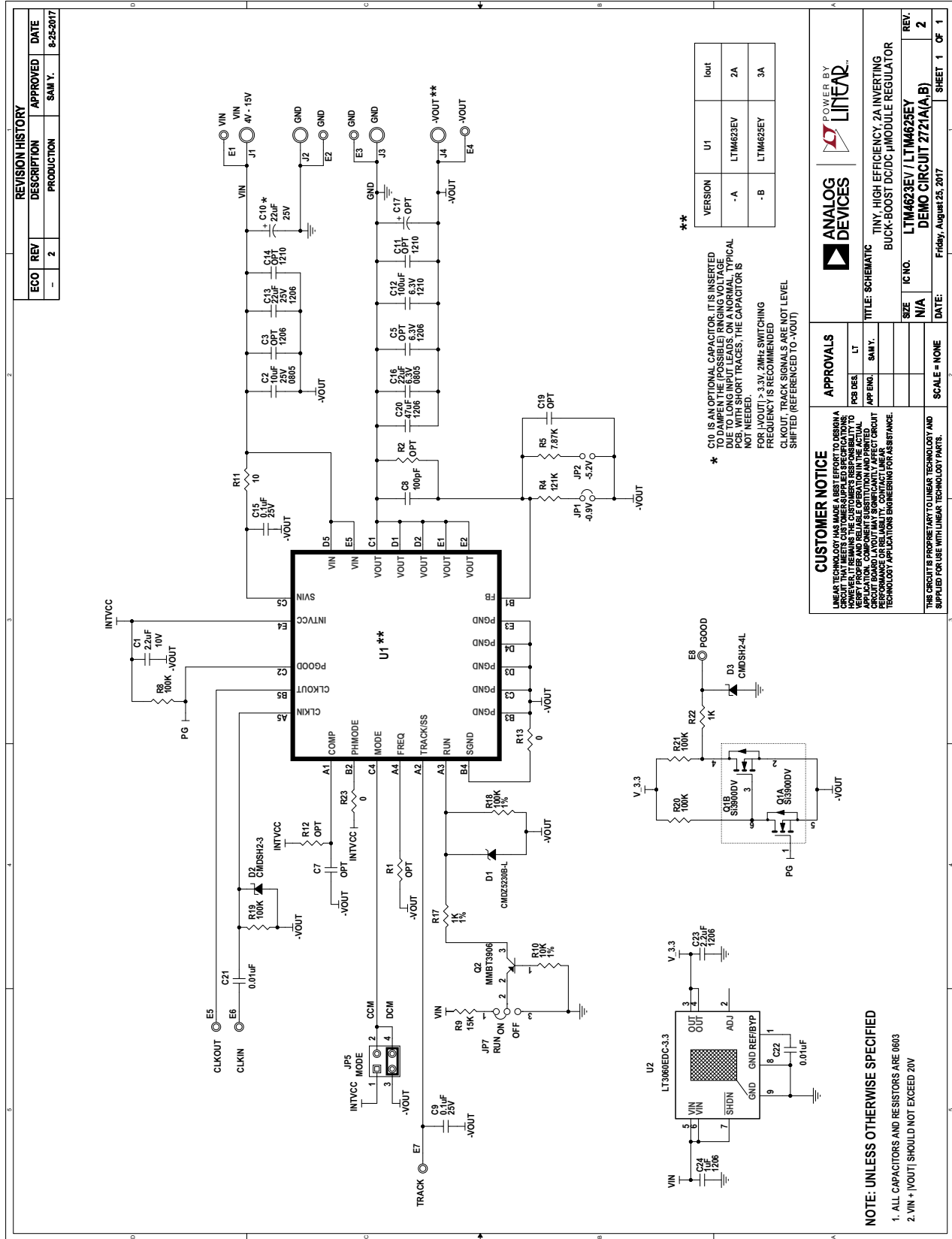

DEMO MANUAL

DC2721A-A



ESD Caution

ESD (electrostatic discharge) sensitive device. Charged devices and circuit boards can discharge without detection. Although this product features patented or proprietary protection circuitry, damage may occur on devices subjected to high energy ESD. Therefore, proper ESD precautions should be taken to avoid performance degradation or loss of functionality.

Legal Terms and Conditions

By using the evaluation board discussed herein (together with any tools, components documentation or support materials, the "Evaluation Board"), you are agreeing to be bound by the terms and conditions set forth below ("Agreement") unless you have purchased the Evaluation Board, in which case the Analog Devices Standard Terms and Conditions of Sale shall govern. Do not use the Evaluation Board until you have read and agreed to the Agreement. Your use of the Evaluation Board shall signify your acceptance of the Agreement. This Agreement is made by and between you ("Customer") and Analog Devices, Inc. ("ADI"), with its principal place of business at One Technology Way, Norwood, MA 02062, USA. Subject to the terms and conditions of the Agreement, ADI hereby grants to Customer a free, limited, personal, temporary, non-exclusive, non-sublicensable, non-transferable license to use the Evaluation Board FOR EVALUATION PURPOSES ONLY. Customer understands and agrees that the Evaluation Board is provided for the sole and exclusive purpose referenced above, and agrees not to use the Evaluation Board for any other purpose. Furthermore, the license granted is expressly made subject to the following additional limitations: Customer shall not (i) rent, lease, display, sell, transfer, assign, sublicense, or distribute the Evaluation Board; and (ii) permit any Third Party to access the Evaluation Board. As used herein, the term "Third Party" includes any entity other than ADI, Customer, their employees, affiliates and in-house consultants. The Evaluation Board is NOT sold to Customer; all rights not expressly granted herein, including ownership of the Evaluation Board, are reserved by ADI. CONFIDENTIALITY. This Agreement and the Evaluation Board shall all be considered the confidential and proprietary information of ADI. Customer may not disclose or transfer any portion of the Evaluation Board to any other party for any reason. Upon discontinuation of use of the Evaluation Board or termination of this Agreement, Customer agrees to promptly return the Evaluation Board to ADI. ADDITIONAL RESTRICTIONS. Customer may not disassemble, decompile or reverse engineer chips on the Evaluation Board. Customer shall inform ADI of any occurred damages or any modifications or alterations it makes to the Evaluation Board, including but not limited to soldering or any other activity that affects the material content of the Evaluation Board. Modifications to the Evaluation Board must comply with applicable law, including but not limited to the RoHS Directive. TERMINATION. ADI may terminate this Agreement at any time upon giving written notice to Customer. Customer agrees to return to ADI the Evaluation Board at that time. LIMITATION OF LIABILITY. THE EVALUATION BOARD PROVIDED HEREUNDER IS PROVIDED "AS IS" AND ADI MAKES NO WARRANTIES OR REPRESENTATIONS OF ANY KIND WITH RESPECT TO IT. ADI SPECIFICALLY DISCLAIMS ANY REPRESENTATIONS, ENDORSEMENTS, GUARANTEES, OR WARRANTIES, EXPRESS OR IMPLIED, RELATED TO THE EVALUATION BOARD INCLUDING, BUT NOT LIMITED TO, THE IMPLIED WARRANTY OF MERCHANTABILITY, TITLE, FITNESS FOR A PARTICULAR PURPOSE OR NON-INFRINGEMENT OF INTELLECTUAL PROPERTY RIGHTS. IN NO EVENT WILL ADI AND ITS LICENSORS BE LIABLE FOR ANY INCIDENTAL, SPECIAL, INDIRECT, OR CONSEQUENTIAL DAMAGES RESULTING FROM CUSTOMER'S POSSESSION OR USE OF THE EVALUATION BOARD, INCLUDING BUT NOT LIMITED TO LOST PROFITS, DELAY COSTS, LABOR COSTS OR LOSS OF GOODWILL. ADI'S TOTAL LIABILITY FROM ANY AND ALL CAUSES SHALL BE LIMITED TO THE AMOUNT OF ONE HUNDRED US DOLLARS (\$100.00). EXPORT. Customer agrees that it will not directly or indirectly export the Evaluation Board to another country, and that it will comply with all applicable United States federal laws and regulations relating to exports. GOVERNING LAW. This Agreement shall be governed by and construed in accordance with the substantive laws of the Commonwealth of Massachusetts (excluding conflict of law rules). Any legal action regarding this Agreement will be heard in the state or federal courts having jurisdiction in Suffolk County, Massachusetts, and Customer hereby submits to the personal jurisdiction and venue of such courts. The United Nations Convention on Contracts for the International Sale of Goods shall not apply to this Agreement and is expressly disclaimed.