

## ILONA-W

~35° wide beam

### TECHNICAL SPECIFICATIONS:

Dimensions	Ø 49.8 mm
Height	29.7 mm
Fastening	socket
ROHS compliant	yes ⓘ

### MATERIAL SPECIFICATIONS:

Component	Type	Material	Colour	Finish
ILONA-W	Single lens	PMMA	clear	

### ORDERING INFORMATION:





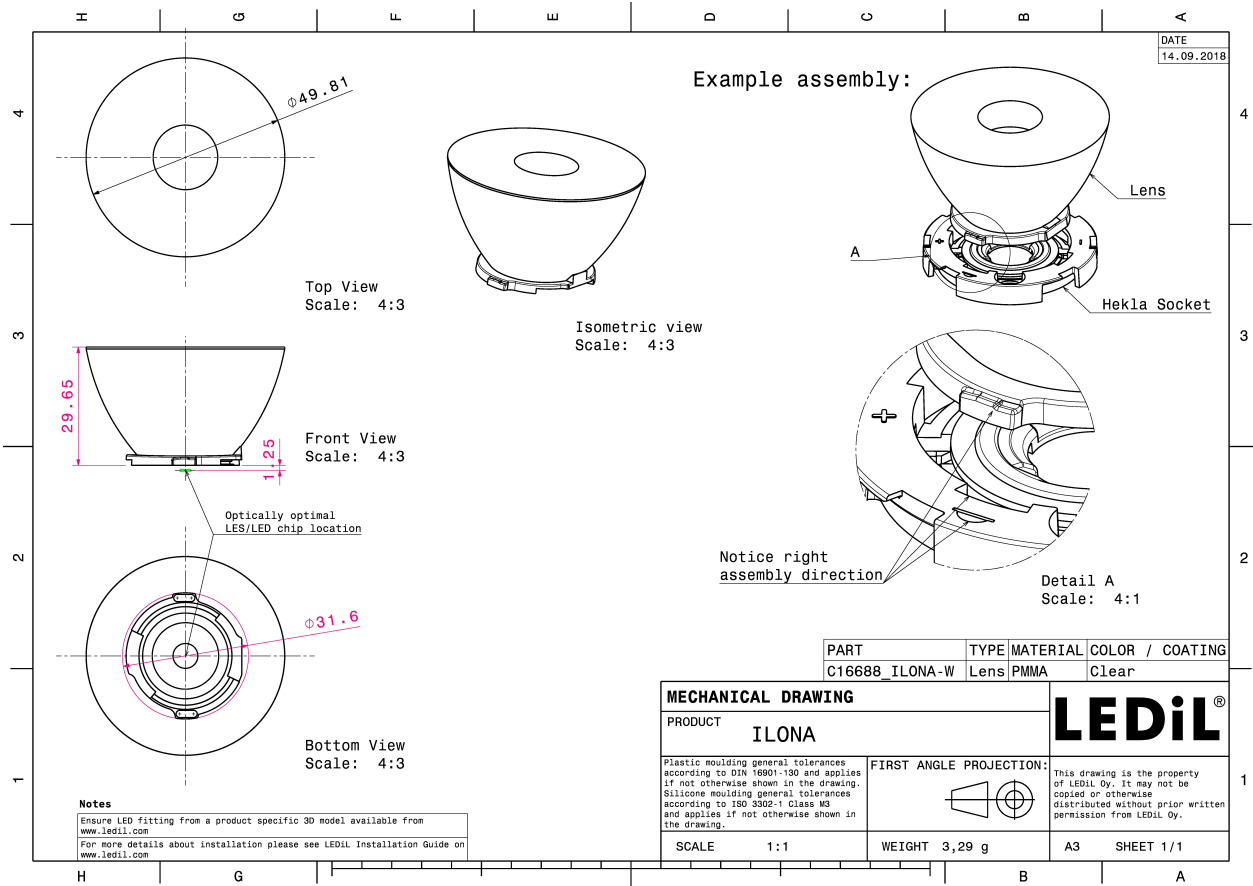

Component	Qty in box	MOQ	MPQ	Box weight (kg)
C16688_ILONA-W » Box size: 480 x 280 x 300 mm	297	99	33	11.3



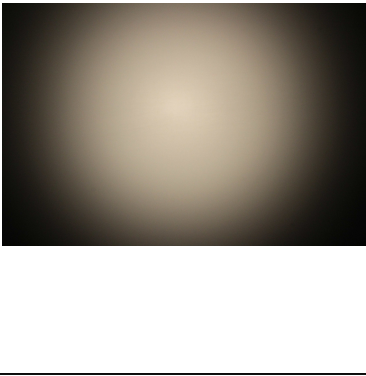
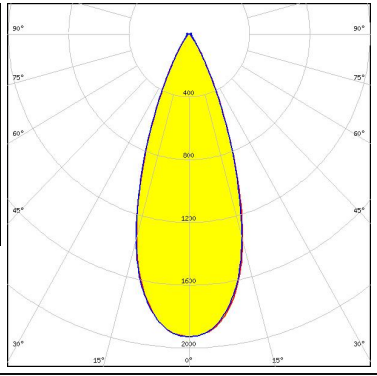

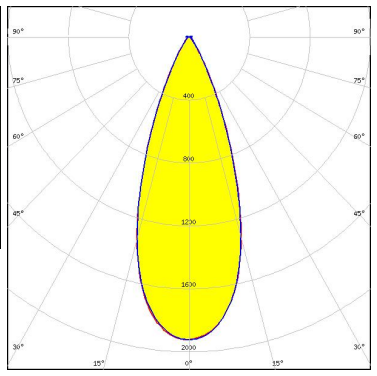
See also our general installation guide: [www.ledil.com/installation\\_guide](http://www.ledil.com/installation_guide)

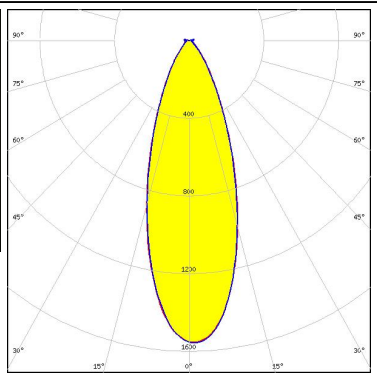
#### PHOTOMETRIC DATA (MEASURED):

<p>bridgelux.</p> <p>LED V6 HD</p> <p>FWHM / FWTM 39.0° / 62.0°</p> <p>Efficiency 93 %</p> <p>Peak intensity 1.9 cd/m</p> <p>LEDs/each optic 1</p> <p>Light colour White</p> <p>Required components: F15255_HEKLA-SOCKET-C</p>		
<p>bridgelux.</p> <p>LED V6 HD</p> <p>FWHM / FWTM 38.0° / 62.0°</p> <p>Efficiency 93 %</p> <p>Peak intensity 1.9 cd/m</p> <p>LEDs/each optic 1</p> <p>Light colour White</p> <p>Required components: Bender Wirth: 634c Hekla</p>		
<p>bridgelux.</p> <p>LED Vesta DTW 13mm (21W)</p> <p>FWHM / FWTM 35.0° / 72.0°</p> <p>Efficiency 87 %</p> <p>Peak intensity 1.6 cd/m</p> <p>LEDs/each optic 1</p> <p>Light colour Tunable White</p> <p>Required components: C16142_HEKLA-SOCKET-K Bender Wirth: 491 Typ L8</p>		
<p>bridgelux.</p> <p>LED Vesta TW 6mm DP</p> <p>FWHM / FWTM 39.0° / 63.0°</p> <p>Efficiency 88 %</p> <p>Peak intensity 1.8 cd/m</p> <p>LEDs/each optic 1</p> <p>Light colour White</p> <p>Required components: C16142_HEKLA-SOCKET-K Bender Wirth: 504 Typ L8</p>		

#### PHOTOMETRIC DATA (MEASURED):

### CITIZEN

LED CLU7B2  
 FWHM / FWTM 41.0° / 61.0°  
 Efficiency 92 %  
 Peak intensity 1.9 cd/lm  
 LEDs/each optic 1  
 Light colour White  
 Required components:  
 F15255\_HEKLA-SOCKET-C

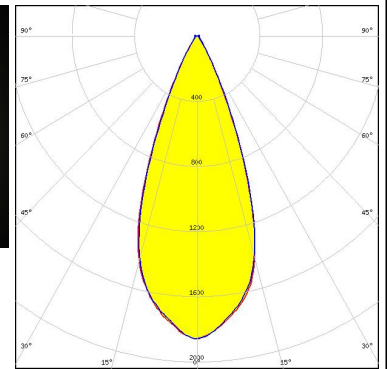
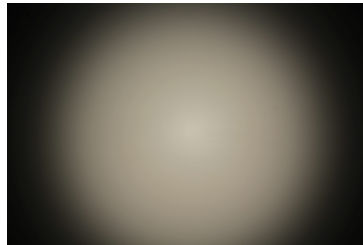

### LUMILEDS

LED LUXEON CX Plus CoB L08 (Gen2)  
 FWHM / FWTM 36.0° / 72.0°  
 Efficiency 90 %  
 Peak intensity 1.6 cd/lm  
 LEDs/each optic 1  
 Light colour White  
 Required components:  
 Bender Wirth: 637a Hekla

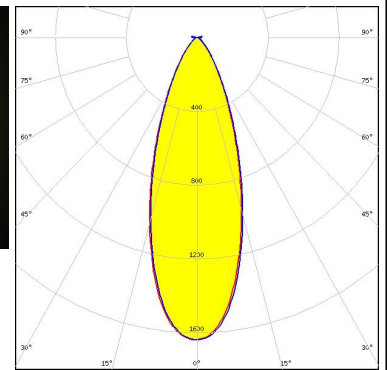
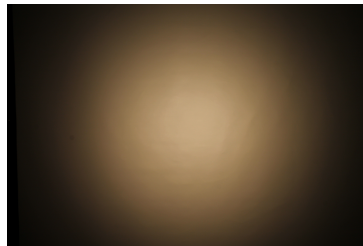

### LUMILEDS

LED LUXEON CX Plus CoB - HD S01H4  
 FWHM / FWTM 39.0° / 61.0°  
 Efficiency 93 %  
 Peak intensity 2 cd/lm  
 LEDs/each optic 1  
 Light colour White  
 Required components:  
 Bender Wirth: 634c Hekla

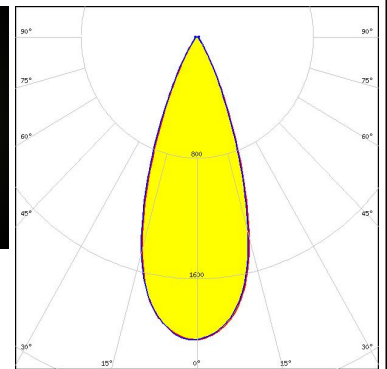
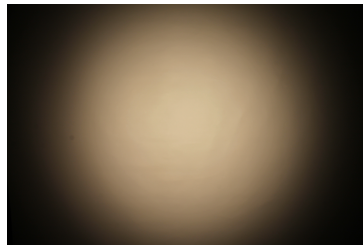



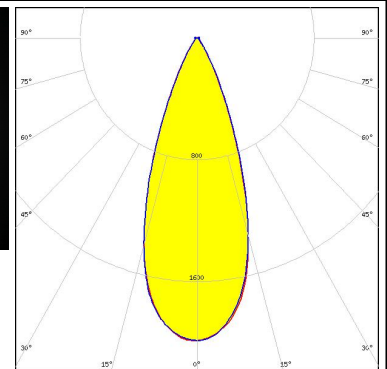
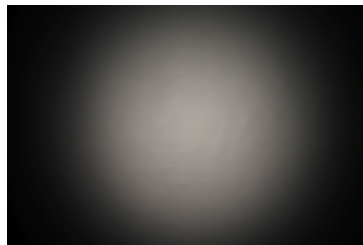

### LUMILEDS



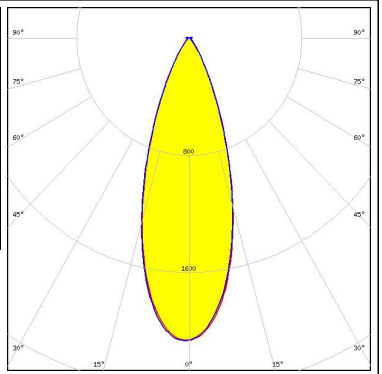
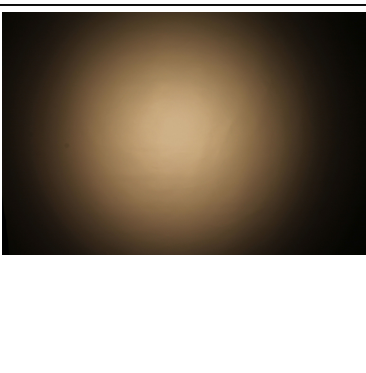
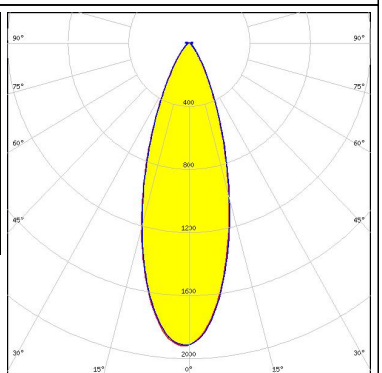

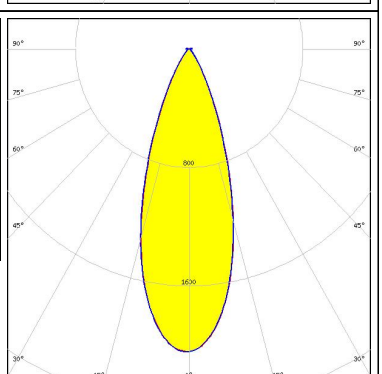
LED LUXEON CX Plus CoB - HD S01H6 / HD S02H6  
 FWHM / FWTM 38.0° / 61.0°  
 Efficiency 93 %  
 Peak intensity 2 cd/lm  
 LEDs/each optic 1  
 Light colour White  
 Required components:  
 Bender Wirth: 634c Hekla

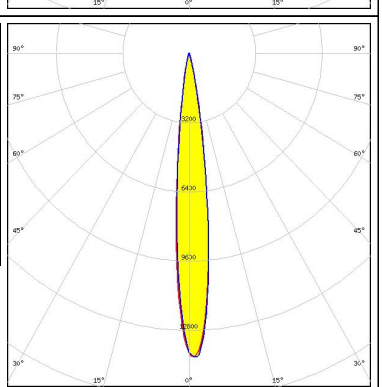



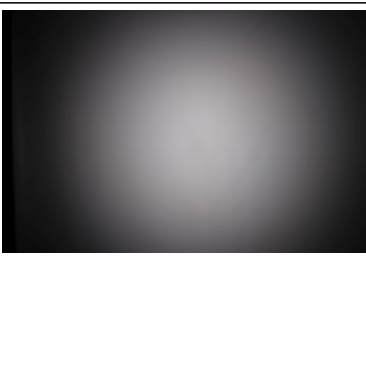
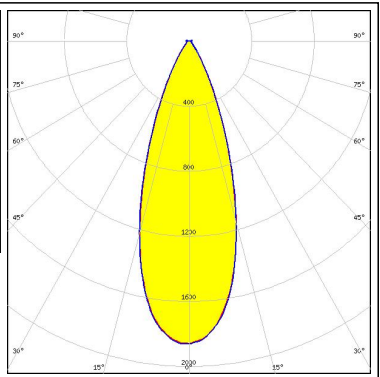
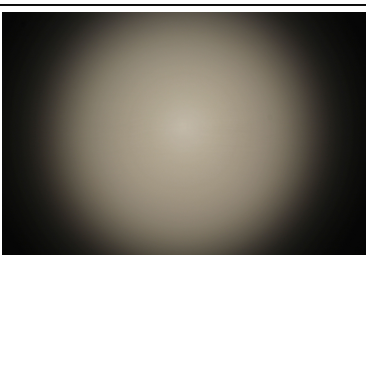
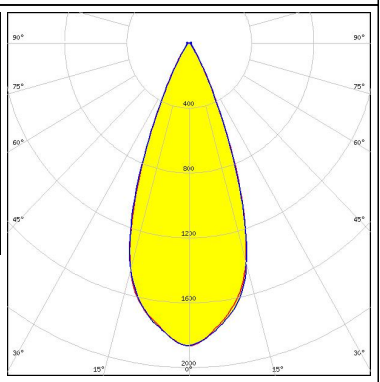

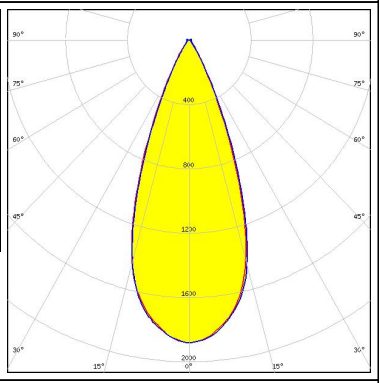

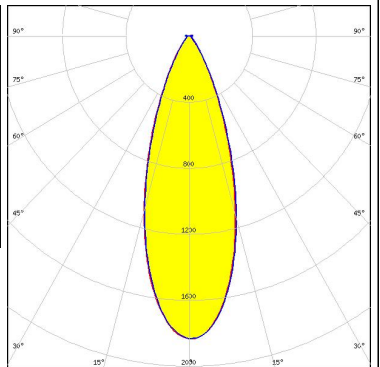
#### PHOTOMETRIC DATA (MEASURED):

<p><b>LUMILEDS</b></p> <p>LED LUXEON CX Plus CoB - HD S04H9</p> <p>FWHM / FWTM 35.0° / 63.0°</p> <p>Efficiency 92 %</p> <p>Peak intensity 2.1 cd/lm</p> <p>LEDs/each optic 1</p> <p>Light colour White</p> <p>Required components: Bender Wirth: 634c Hekla</p>		
<p><b>LUMILEDS</b></p> <p>LED LUXEON CX Plus CoB L04 / L05 (Gen2)</p> <p>FWHM / FWTM 34.0° / 66.0°</p> <p>Efficiency 92 %</p> <p>Peak intensity 1.9 cd/lm</p> <p>LEDs/each optic 1</p> <p>Light colour White</p> <p>Required components: Bender Wirth: 637a Hekla</p>		
<p><b>LUMILEDS</b></p> <p>LED LUXEON CX Plus CoB M02 / M03 (Gen2)</p> <p>FWHM / FWTM 35.0° / 63.0°</p> <p>Efficiency 92 %</p> <p>Peak intensity 2 cd/lm</p> <p>LEDs/each optic 1</p> <p>Light colour White</p> <p>Required components: Bender Wirth: 641a Hekla</p>		
<p><b>LUMILEDS</b></p> <p>LED LUXEON CX Plus CoB S01 (Gen2)</p> <p>FWHM / FWTM 12.0° / 23.0°</p> <p>Efficiency 94 %</p> <p>Peak intensity 14.3 cd/lm</p> <p>LEDs/each optic 1</p> <p>Light colour White</p> <p>Required components: Bender Wirth: 634c Hekla</p>		

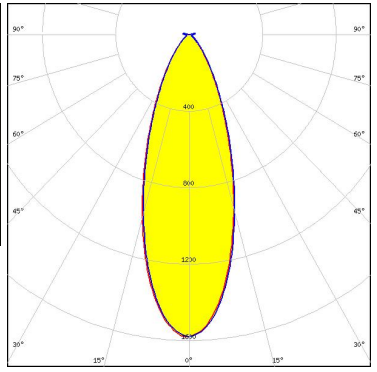

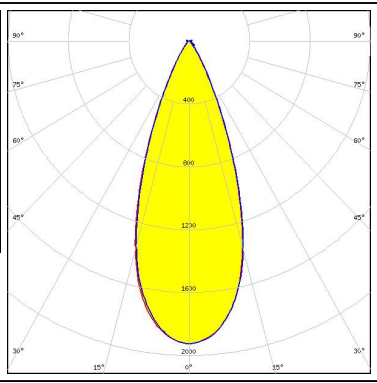

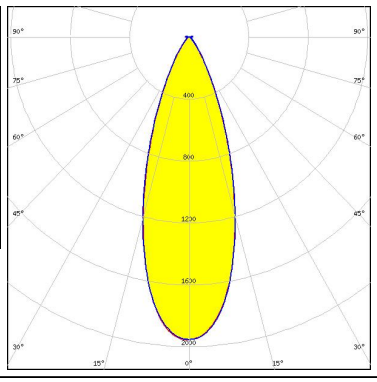

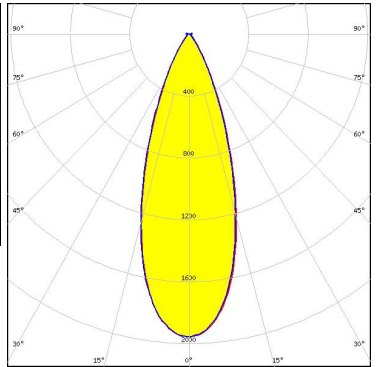
#### PHOTOMETRIC DATA (MEASURED):

<p><b>LUMILEDS</b></p> <p>LED LUXEON Fusion 21-up (20x24)</p> <p>FWHM / FWTM 37.0° / 64.0°</p> <p>Efficiency 91 %</p> <p>Peak intensity 1.9 cd/m</p> <p>LEDs/each optic 21</p> <p>Light colour White</p> <p>Required components: C16142_HEKLA-SOCKET-K Bender Wirth: 442 Typ L8</p>		
<p><b>LUMINUS</b></p> <p>LED CXM-3</p> <p>FWHM / FWTM 41.0° / 61.0°</p> <p>Efficiency 93 %</p> <p>Peak intensity 1.9 cd/m</p> <p>LEDs/each optic 1</p> <p>Light colour White</p> <p>Required components: F15255_HEKLA-SOCKET-C</p>		
<p><b>LUMINUS</b></p> <p>LED CXM-4</p> <p>FWHM / FWTM 41.0° / 62.0°</p> <p>Efficiency 94 %</p> <p>Peak intensity 1.9 cd/m</p> <p>LEDs/each optic 1</p> <p>Light colour White</p> <p>Required components: F15255_HEKLA-SOCKET-C</p>		
<p><b>SAMSUNG</b></p> <p>LED LC010T (Tunable White)</p> <p>FWHM / FWTM 35.0° / 65.0°</p> <p>Efficiency 90 %</p> <p>Peak intensity 1.8 cd/m</p> <p>LEDs/each optic 1</p> <p>Light colour Tunable White</p> <p>Required components: C16142_HEKLA-SOCKET-K Bender Wirth: 501 Typ L8</p>		

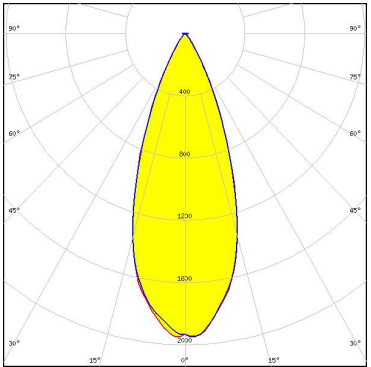
#### PHOTOMETRIC DATA (MEASURED):

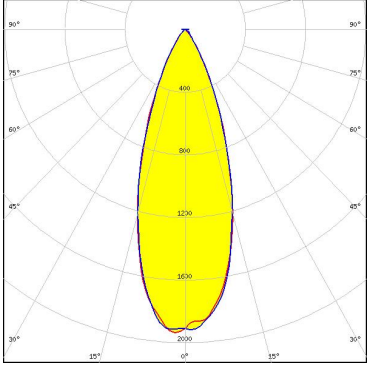
<p><b>SEOUL SEMICONDUCTOR</b></p> <p>LED MJT COB LES 14.5</p> <p>FWHM / FWTM 36.0° / 74.0°</p> <p>Efficiency 90 %</p> <p>Peak intensity 1.6 cd/lm</p> <p>LEDs/each optic 1</p> <p>Light colour White</p> <p>Required components: F17438_HEKLA-G2-I</p>		
<p><b>SEOUL SEMICONDUCTOR</b></p> <p>LED MJT COB LES 6</p> <p>FWHM / FWTM 39.0° / 63.0°</p> <p>Efficiency 94 %</p> <p>Peak intensity 1.9 cd/lm</p> <p>LEDs/each optic 1</p> <p>Light colour White</p> <p>Required components: F17435_HEKLA-G2-C</p>		
<p><b>SEOUL SEMICONDUCTOR</b></p> <p>LED MJT COB LES 9.8</p> <p>FWHM / FWTM 35.0° / 65.0°</p> <p>Efficiency 93 %</p> <p>Peak intensity 2 cd/lm</p> <p>LEDs/each optic 1</p> <p>Light colour White</p> <p>Required components: F17435_HEKLA-G2-C</p>		
<p><b>TRIDONIC</b></p> <p>LED SLE G7 LES09</p> <p>FWHM / FWTM 36.0° / 64.0°</p> <p>Efficiency 92 %</p> <p>Peak intensity 2 cd/lm</p> <p>LEDs/each optic 1</p> <p>Light colour White</p> <p>Required components: F15255_HEKLA-SOCKET-C</p>		

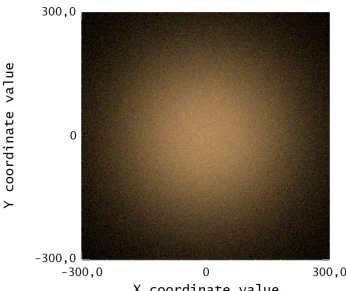
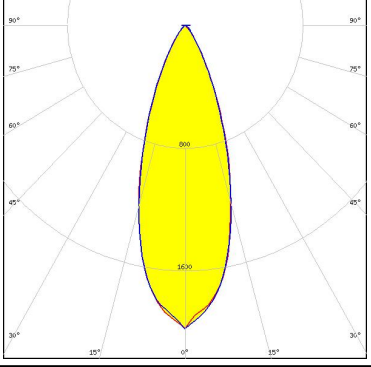
### PHOTOMETRIC DATA (SIMULATED):

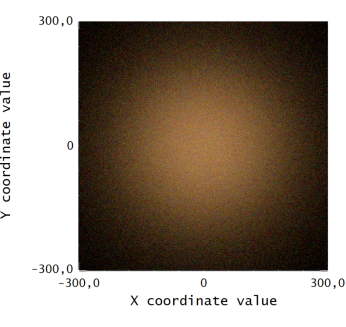
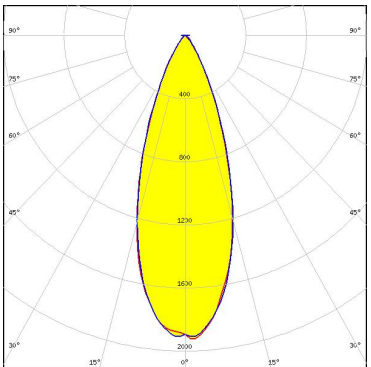
	<p>LED V4 HD            FWHM / FWTM 38.0° / 64.0°            Efficiency 91 %            Peak intensity 2 cd/lm            LEDs/each optic 1            Light colour White            Required components:            F15253_HEKLA-SOCKET-A</p>		
	<p>LED V9 HD            FWHM / FWTM 36.0° / 64.0°            Efficiency 89 %            Peak intensity 2 cd/lm            LEDs/each optic 1            Light colour White            Required components:            F15859_HEKLA-SOCKET-I</p>		
	<p>LED VERO10            FWHM / FWTM 36.0° / 64.0°            Efficiency 90 %            Peak intensity 2 cd/lm            LEDs/each optic 1            Light colour White            Required components:            F15616_HEKLA-SOCKET-F</p>		
	<p>LED Vesta DTW 9mm (4W/6W/12W)            FWHM / FWTM 36.0° / 64.0°            Efficiency 90 %            Peak intensity 1.9 cd/lm            LEDs/each optic 1            Light colour White            Required components:            C16142_HEKLA-SOCKET-K            Bender Wirth: 490 Typ L8</p>		



#### PHOTOMETRIC DATA (SIMULATED):

### CITIZEN

LED CLL02x/CLU02x (LES10)  
 FWHM / FWTM 35.0° / 64.0°  
 Efficiency 79 %  
 Peak intensity 1.9 cd/lm  
 LEDs/each optic 1  
 Light colour White  
 Required components:  
 F15255\_HEKLA-SOCKET-C

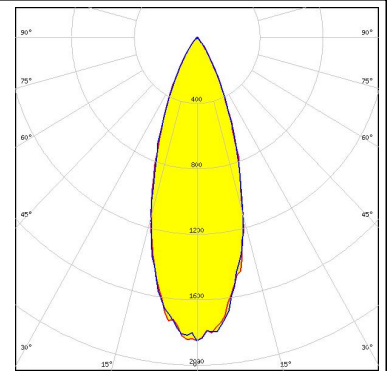

### CITIZEN

LED CLU700/701/702  
 FWHM / FWTM 38.0° / 63.0°  
 Efficiency 84 %  
 Peak intensity 2 cd/lm  
 LEDs/each optic 1  
 Light colour White  
 Required components:  
 F15255\_HEKLA-SOCKET-C

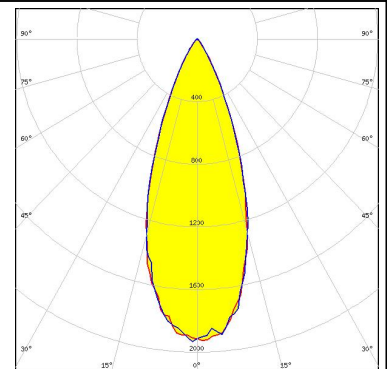

### CREE

LED CMA1825  
 FWHM / FWTM 35.0° / 68.0°  
 Efficiency 87 %  
 Peak intensity 1.8 cd/lm  
 LEDs/each optic 1  
 Light colour White  
 Required components:  
 F15254\_HEKLA-SOCKET-B

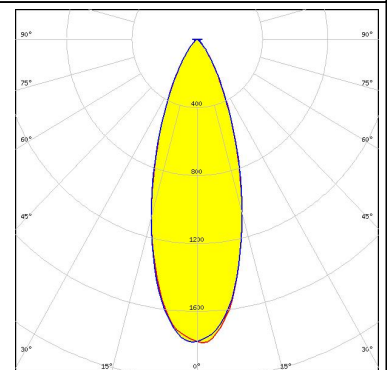

### LUMILEDS

LED LUXEON CoB 1202/1203  
 FWHM / FWTM 36.0° / 66.0°  
 Efficiency 88 %  
 Peak intensity 1.9 cd/lm  
 LEDs/each optic 1  
 Light colour White  
 Required components:  
 F17437\_HEKLA-G2-H

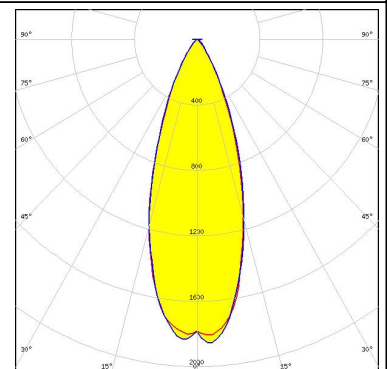

#### PHOTOMETRIC DATA (SIMULATED):

#### LUMILEDS

LED LUXEON CoB 1202s  
 FWHM / FWTM 36.0° / 64.0°  
 Efficiency 91 %  
 Peak intensity 2.1 cd/lm  
 LEDs/each optic 1  
 Light colour White  
 Required components:

#### LUMILEDS

LED LUXEON CoB 1204/1205  
 FWHM / FWTM 35.0° / 69.0°  
 Efficiency 87 %  
 Peak intensity 1.8 cd/lm  
 LEDs/each optic 1  
 Light colour White  
 Required components:

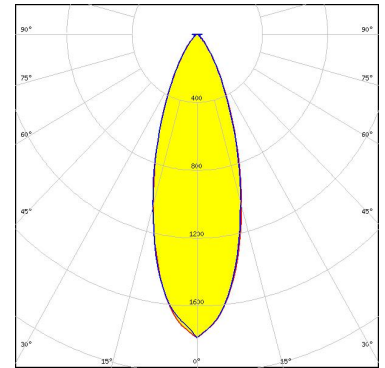

#### LUMILEDS

LED LUXEON CoB 1208  
 FWHM / FWTM 32.0° / 62.0°  
 Efficiency 88 %  
 Peak intensity 2.1 cd/lm  
 LEDs/each optic 1  
 Light colour White  
 Required components:

#### NICHIA

LED COB S-Type (LES 7)  
 FWHM / FWTM 36.0° / 64.0°  
 Efficiency 90 %  
 Peak intensity 1.9 cd/lm  
 LEDs/each optic 1  
 Light colour White  
 Required components:  
 F15848\_HEKLA-SOCKET-G

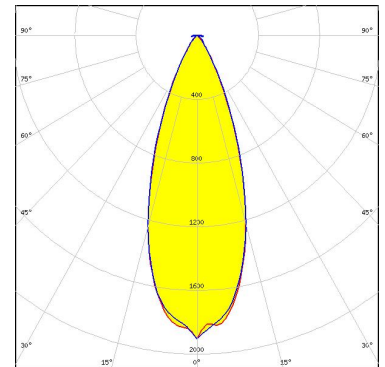

#### PHOTOMETRIC DATA (SIMULATED):

<p><b>NICHIA</b></p> <p>LED NFSWE11A            FWHM / FWTM 36.0° / 65.0°            Efficiency 83 %            Peak intensity 1.8 cd/lm            LEDs/each optic 30            Light colour White            Required components:            C16142_HEKLA-SOCKET-K</p>	
<p><b>OSRAM</b>  <small>Opto Semiconductors</small></p> <p>LED Duris S8            FWHM / FWTM 38.0° / 64.0°            Efficiency 88 %            Peak intensity 2 cd/lm            LEDs/each optic 1            Light colour White            Required components:            F15848_HEKLA-SOCKET-G</p>	
<p><b>SAMSUNG</b></p> <p>LED LC003D / LC006D / LC009D / LC013D            FWHM / FWTM 35.0° / 64.0°            Efficiency 80 %            Peak intensity 1.9 cd/lm            LEDs/each optic 1            Light colour White            Required components:            F15255_HEKLA-SOCKET-C</p>	
<p><b>SAMSUNG</b></p> <p>LED LC010C            FWHM / FWTM 38.0° / 64.0°            Efficiency 87 %            Peak intensity 1.9 cd/lm            LEDs/each optic 1            Light colour White            Required components:            F15848_HEKLA-SOCKET-G</p>	

### PHOTOMETRIC DATA (SIMULATED):

#### SAMSUNG

LED LC020C  
FWHM / FWTM 34.0° / 62.0°  
Efficiency 90 %  
Peak intensity 2.2 cd/lm  
LEDs/each optic 1  
Light colour White  
Required components:  
F17438\_HEKLA-G2-I

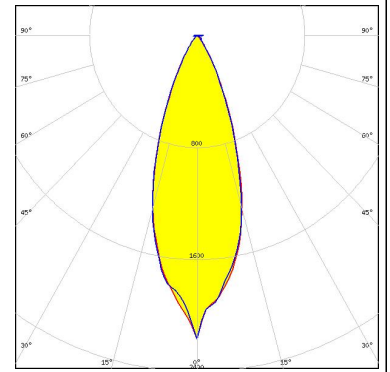

#### XICATO

LED XTM - 9mm LES  
FWHM / FWTM 35.0° / 64.0°  
Efficiency 89 %  
Peak intensity 2 cd/lm  
LEDs/each optic 1  
Light colour White  
Required components:  
C15743\_XTM-ADAPTER-50-B

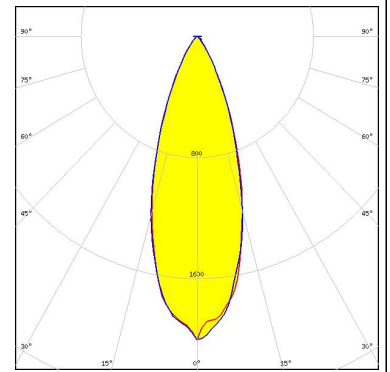

### GENERAL INFORMATION:

NOTE: The typical beam angle will be changed by different color, chip size and chip position tolerance. The typical total beam angle is the full angle measured where the luminous intensity is half of the peak value.

Due to use of high power COB's with this product, special attention to proper thermal design is highly recommended. LEDiL has no liability for direct, indirect or consecutive damages arising from the LEDiL products being used outside of the recommended temperature range.

### MATERIALS:

As part of our continuous research and improvement processes, and to ensure the best possible quality and availability of our products, LEDiL reserves the right to change material grades without notice.

### PRODUCT DATA USER AGREEMENT AND DISCLAIMER:

The measured data in the provided downloadable LEDiL Product Datasheets and Mechanical 2D-Drawings is rounded and provided as reference for planning. LEDiL Oy's optical specifications have been verified by conducting performance testing of the products in accordance with the company's quality system. The reported data are averaged results of multiple measurements with typical variation. LEDiL Oy reserves the right to without prior notification make changes and improvements to its products.

LEDiL Oy assumes neither warranty, nor guarantee nor any other liability of any kind for the contents and correctness of the provided data. The provided data has been generated with highest diligence but the provided data may in reality not represent the complete possible variation range of all intrinsic parameters. Therefore, in certain cases a deviation from the provided data could occur.

LEDiL Oy reserves the right to undertake technical changes of its products without further notification which could lead to changes in the provided data. LEDiL Oy assumes no liability of any kind for the possible deviation from any provided data or any other damage resulting from the usage of the provided data.

The user agrees to this disclaimer and user agreement with the download or usage of the provided files.

#### LEDiL Oy

Joensuunkatu 13  
FI-24240 SALO  
Finland

#### LEDiL Inc.

228 West Page Street  
Suite D  
Sycamore IL 60178  
USA

#### Ledil Optics Technology (Shenzhen) Co., Ltd.

# 405 , Block B  
Casic Motor Building  
Shenzhen 518057  
P.R.CHINA

#### Local sales and technical support

[www.ledil.com/  
where\\_to\\_buy](http://www.ledil.com/where_to_buy)

#### Shipping locations

Salo, Finland  
Hong Kong, China

#### Distribution Partners

[www.ledil.com/  
where\\_to\\_buy](http://www.ledil.com/where_to_buy)