



American Opto Plus LED Corp.

L933-UV265-2-50

3.45 x 3.45 x 1.80mm Dome Lens Power UVC LED

PACKAGE OUTLINES

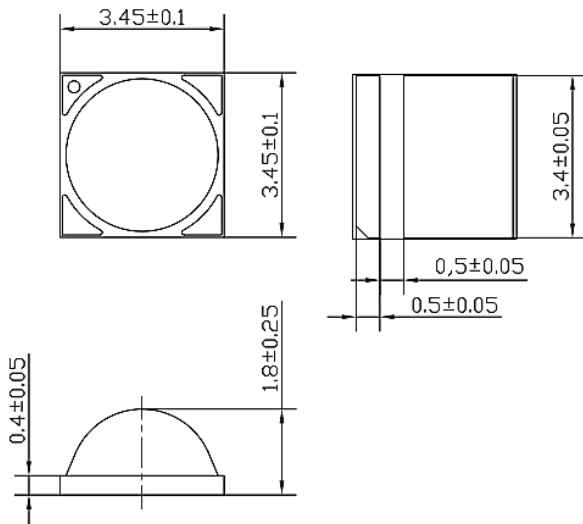

PAD CONFIGURATION

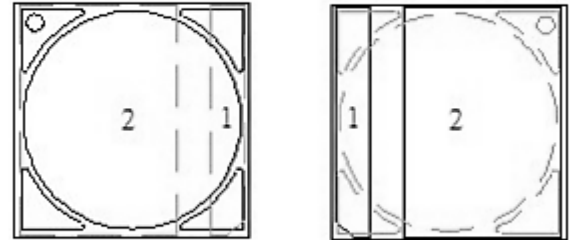

TOP

BOTTOM

PAD	Function
1	Cathode
2	Anode, Thermal



Electrostatic Sensitive Devices

WARNING:

- UV LEDs emit light in the ultraviolet region (UV light).
- UV light is invisible and may be harmful to the human eye.
- Do not expose the eyes directly to the UV light. Wearing appropriate protective gear when handling.
- Use appropriate warning signs/ labels on the devices equipped with UV LEDs.

Items	Description
Viewing Angle	120°
Emitted Color	Deep UltraViolet

Notes:

1. Please don't put conductive material on the top surface of LEDs.



American Opto Plus LED Corp.
L933-UV265-2-50
3.45 x 3.45 x 1.80mm Dome Lens Power UVC LED

RECOMMENDED SOLDER PATTERN

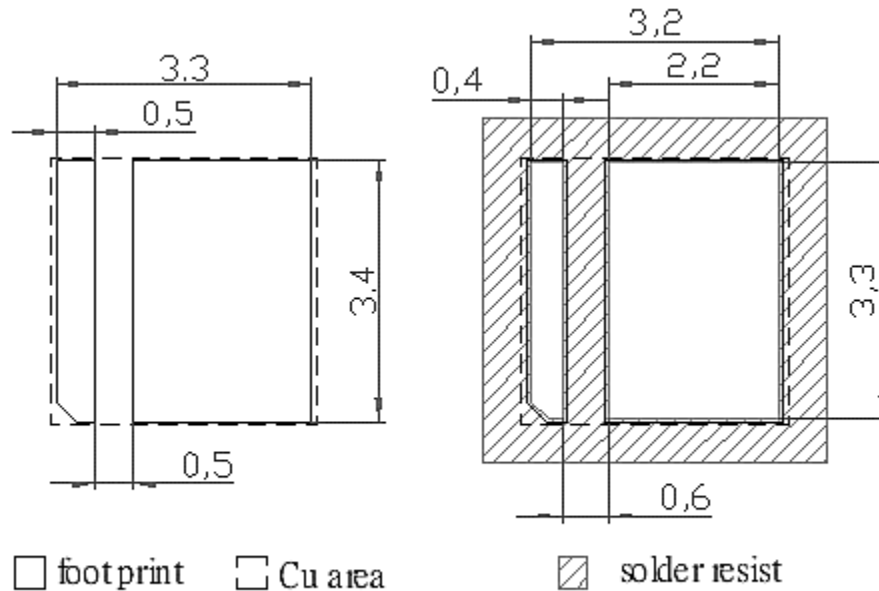

Fig. Solder Pad Layout.

RECOMMENDED CIRCUIT LAYOUT

- Line width >0.3mm.
- Line spec >0.5mm.
- Distance between circuit and board edge >0.5mm.
- The distance between the circuit and the screw hole is >2.5mm (mainly the screw head is not pressed to the circuit)
- It is recommended to design the copper area over the PAD size and fill the board as much as possible (in increase the heat dissipation area).
- Please reserve a reasonable electrode welding wire processing space.



American Opto Plus LED Corp.

L933-UV265-2-50

3.45 x 3.45 x 1.80mm Dome Lens Power UVC LED

ABSOLUTE MAXIMUM RATINGS

(T_j=25°C)

Parameter	Symbol	Value	Unit
Power Dissipation	P	0.5	W
Forward Current	I _F	50	mA
Thermal Resistance, Junction-Case	R _{th,J-C1}	15	°C/W
Operating Temperature	T _{OPR}	-40 ~ +60°C	
Storage Temperature	T _{STG}	-40 ~ +100°C	
Solder Temperature	T _{SOL}	260°C for 5sec	

Note: The thermal resistance value is measured with MCPCB(Star).

OPTICAL-ELECTRICAL CHARACTERISTICS

(T_j=25°C)

Parameter	Symbol	Test Condition	Min	Typ	Max	Unit
Peak Wavelength	λ _p	I _F =50mA	265	--	278	nm
Radiant Flux	Φ _e		4	7.5	--	mW
Radiant Irradiance	E _e		--	1.8	--	mW/cm ²
Forward Voltage	V _F		--	7	10	V
Spectral Half-Width	Δλ		--	15	--	nm

Note:

1. Forward voltage measurement allowance is ±0.2V.
2. Radiant flux measurement allowance is ±10%.
3. Irradiance tested at a distance 10mm from lens top.
4. Wavelength measurement allowance is ±3nm.



American Opto Plus LED Corp.

L933-UV265-2-50

3.45 x 3.45 x 1.80mm Dome Lens Power UVC LED

ELECTRICAL-OPTICAL CHARACTERISTICS

Forward Current vs. Forward Voltage

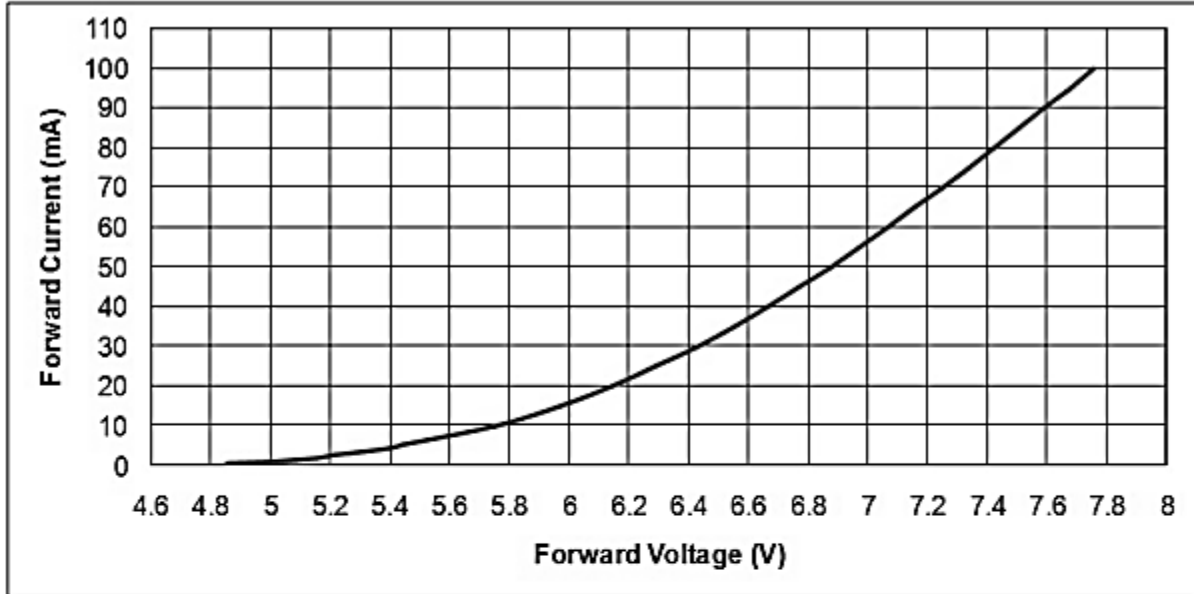

Relative Intensity vs. Forward Current

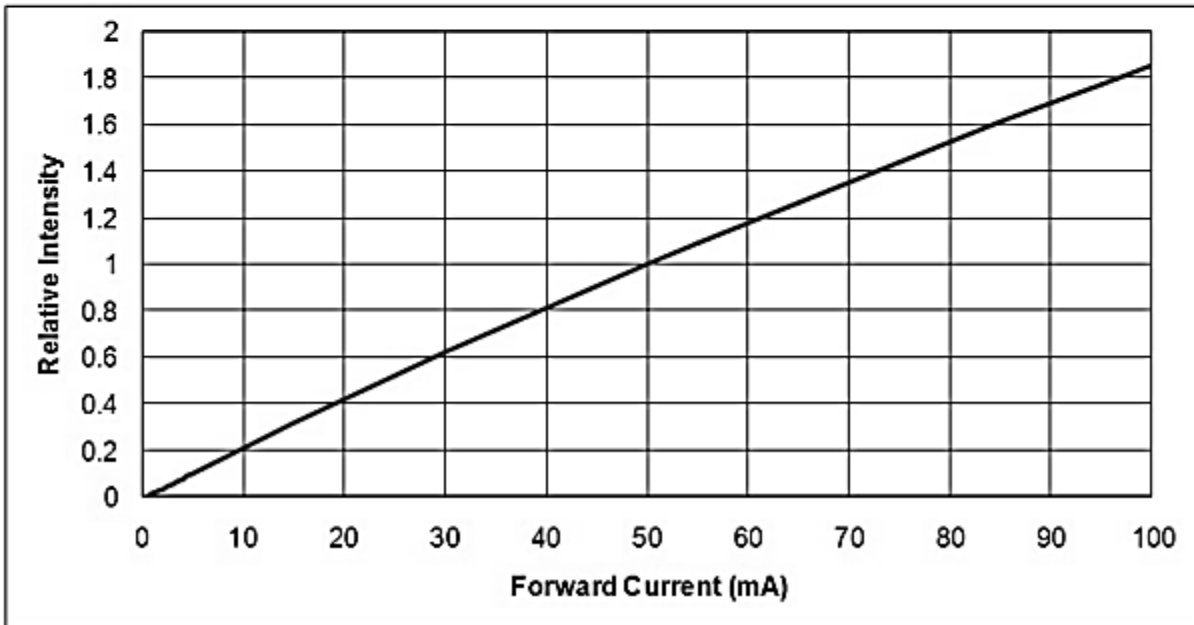



American Opto Plus LED Corp.
L933-UV265-2-50
3.45 x 3.45 x 1.80mm Dome Lens Power UVC LED

Spectral Power Distribution

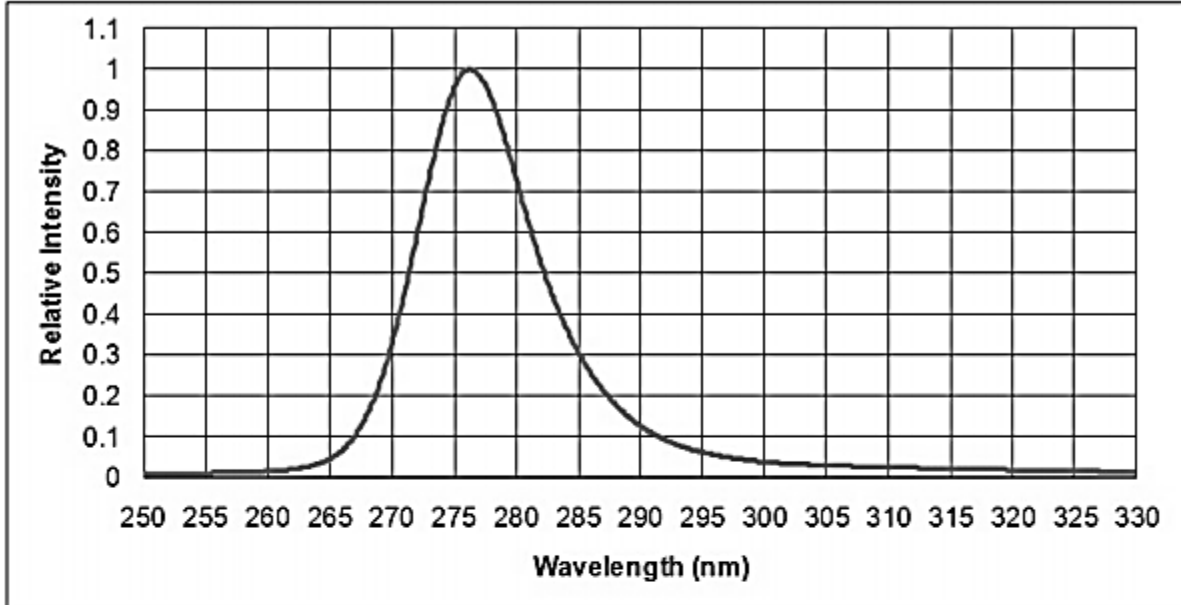

Typical Radiation Pattern

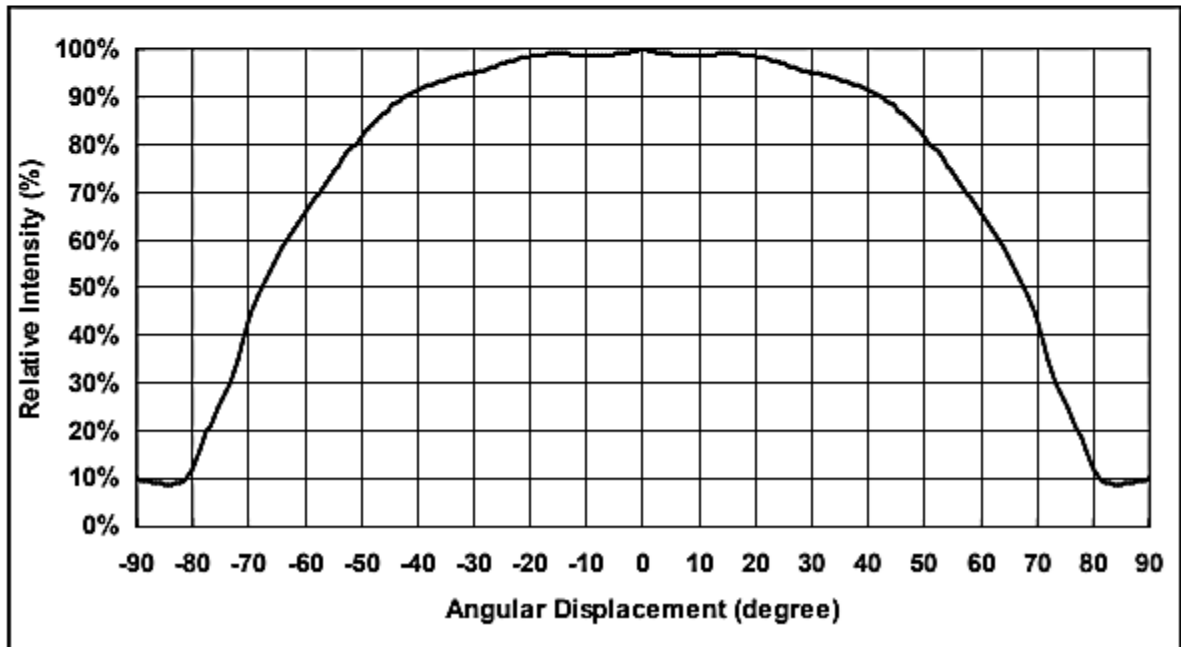



American Opto Plus LED Corp.
L933-UV265-2-50
3.45 x 3.45 x 1.80mm Dome Lens Power UVC LED

BIN CODE LIST FOR REFERENCE

(T_j=25°C)

Item	Bin Code	Symbol	Test Condition	Min	Max	Unit
Forward Voltage	E	V _F	I _F =50mA	5	6	V
	F			6	7	V
	G			7	8	V
	H			8	9	V
	J			9	10	V
Radiant Flux	A40	Φ _e		4	6	mW
	A60			6	10	mW

Note:

1. Bin Rank: V_F- Φ_e
2. Forward voltage measurement allowance is ±0.2V.
3. Radiant flux measurement allowance is ±10%.



American Opto Plus LED Corp.
L933-UV265-2-50
3.45 x 3.45 x 1.80mm Dome Lens Power UVC LED

TAPE DIMENSION

Tapping Dimension Packaging Specification

- Moisture proof bag.
- 1 Reel/bag
- Q'ty: 700(MAX)/Reel
- Unit: mm

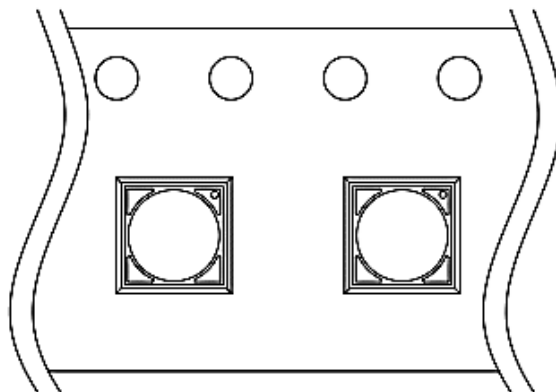
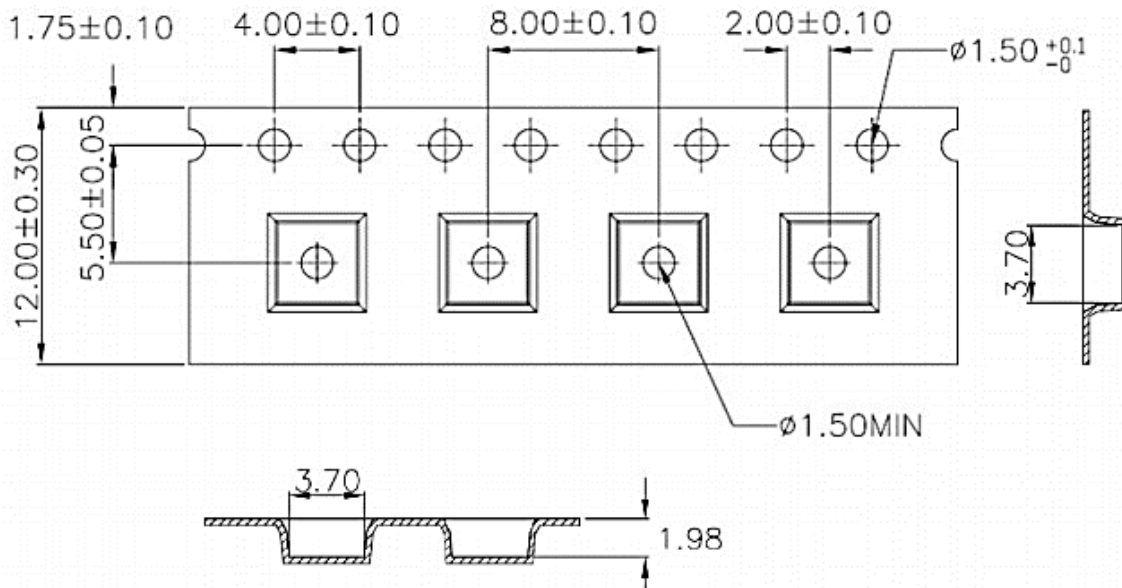



American Opto Plus LED Corp.

L933-UV265-2-50

3.45 x 3.45 x 1.80mm Dome Lens Power UVC LED

LABEL FORMATION

P/N: XXXXXXXXXXXXXXX	BIN Rank : XXXXXXXXXXX
LOT: XXXXXXXXXXXXXXX	Q'ty : XXXX PCS XXX

75mm*8mm

Package

Box Type	Dimension (mm)	Reel/Box	120°Lens Type(Pcs)
Small Box (S)	230x85x265	5 Reel/Box	3500
Middle Box (M)	470x265x270	30 Reel/Box	21000
Large Box (L)	470x435x270	50 Reel/Box	35000

REEL DIMENSION

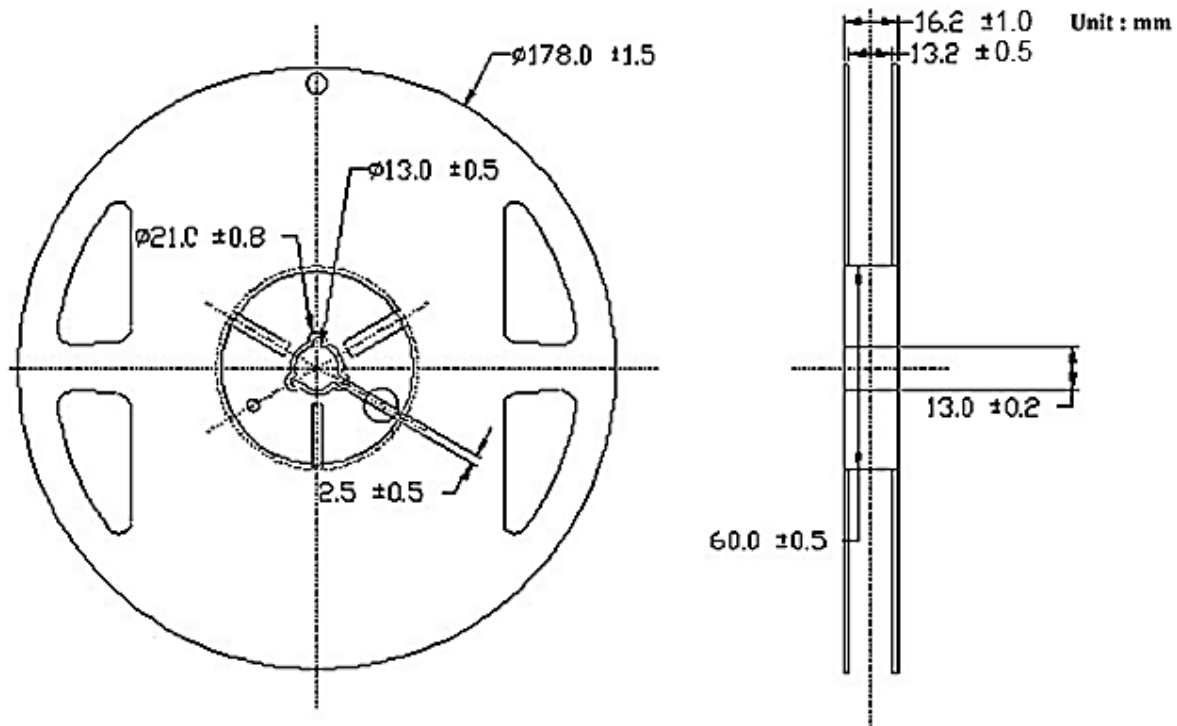



American Opto Plus LED Corp.

L933-UV265-2-50

3.45 x 3.45 x 1.80mm Dome Lens Power UVC LED

SOLDERING CONDITIONS

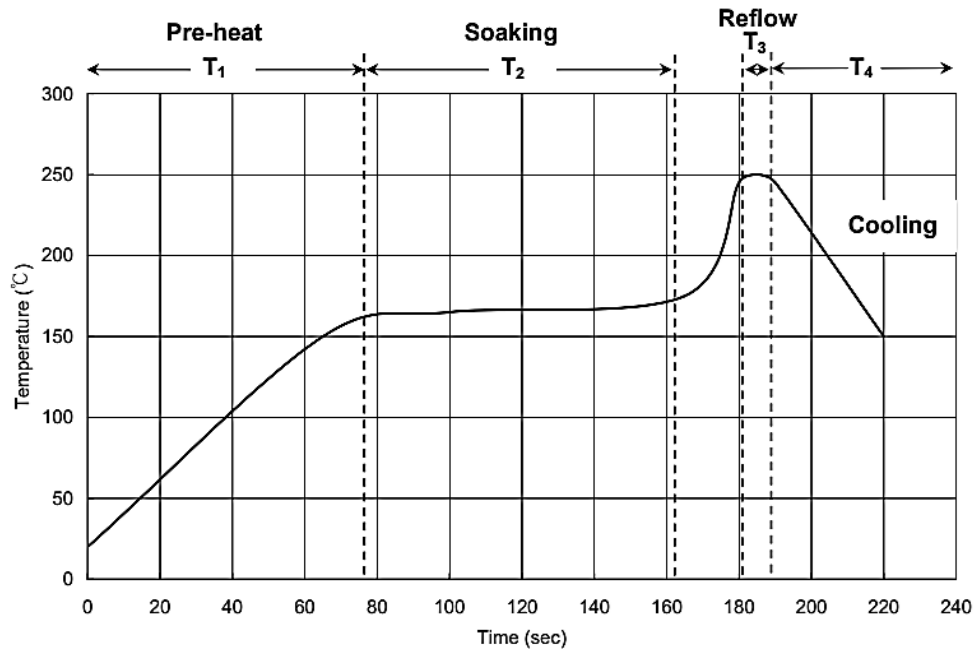

Soldering		
T ₁	Ramp-up Rate	1.0 ~ 3.0 °C/sec
	Pre-heat Time	50 ~ 80 sec
T ₂	Soaking Temperature	155 ~ 185 °C
	Dwell Time During Soaking	60 ~ 120 sec
T ₃	Reflow Temperature	240 ~ 250 °C
	Reflow Time	Max 10 sec
	Ramp-up Rate During Reflow	1.2 ~ 2.3 °C/sec
T ₄	Cooling	1.0 ~ 6.0 °C/sec

Note: Suggest using Sn96Ag3Cu0.5 lead free solder



American Opto Plus LED Corp.

L933-UV265-2-50

3.45 x 3.45 x 1.80mm Dome Lens Power UVC LED

SMT PROCESS

- **Solder Stencil**

The recommended material is stainless steel SUS304, the thickness is 0.12-0.15mm. If the thickness of the steel plate is too thin, the amount of tin is insufficient. If it is too thick, it will overflow the tin beads.

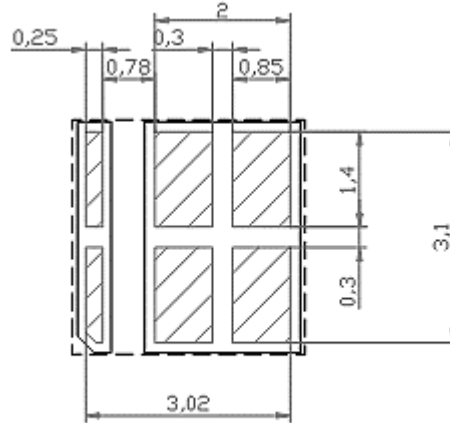

Fig. Solder Stencil

- **SMT Nozzle**

It is recommended to use soft materials, such as rubber, as shown in the left picture of the below figure, and the size in the following figure as an example, in mm.

The inner diameter of the nozzle must be larger than the diameter of the LED lens by 3.2mm to avoid crushing the lens. The outer diameter of the muzzle should not be less than the packaging carrier tape groove. The nozzle does not extend into the carrier tape when SMT process.

When using high-density multiple LED arrays, the nozzle can be changed to peek or other similar materials (does not use metal), and the outer diameter can be reduced to reduce the spacing between the LEDs.

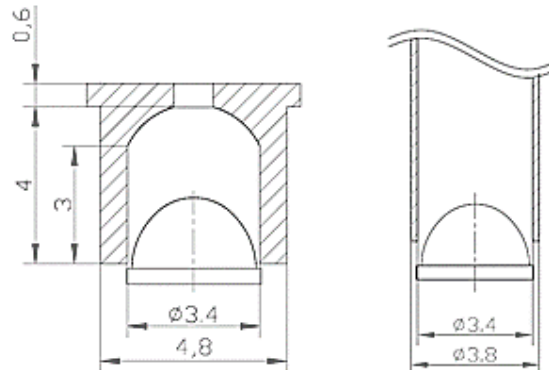



American Opto Plus LED Corp.
L933-UV265-2-50
3.45 x 3.45 x 1.80mm Dome Lens Power UVC LED

PRECAUTION OF USE

Storage

In order to avoid moisture penetration, it is recommended to store the LED in a moisture-proof cabinet at a storage temperature of 5 to 30°C and a relative humidity of less than 50%.

If it is unpacked for more than 72 hours (MSL_4), please bake at 70°C for 2 hours before use.

Cleaning

Use alcohol-based cleaning solvents such as isopropyl alcohol to clean the LED if necessary.

Electrical Test

Test the LED with a small current after SMT. The recommended test condition is 1mA, the upper voltage limit is set to 10V, and the power is turned on after the line is connected, to avoid damage to the LED by surge.

The damage from ESD (Electro Static Discharge) to a LEDs may cause the product to demonstrate unusual characteristics. The following recommendations are suggested to help minimize the potential for an ESD event:

- Work area suggestion: Ionizing fan setup. ESD table/ shelf mat made of conductive materials.
- Personal suggestion: anti-static wrist strap.

LEDs damaged by surge or ESD may have a lower forward voltage. If the forward voltage (V_f) is less than 4 V (1mA testing), it means that the LED has been damaged and caused leakage.



American Opto Plus LED Corp.

L933-UV265-2-50

3.45 x 3.45 x 1.80mm Dome Lens Power UVC LED

Caution

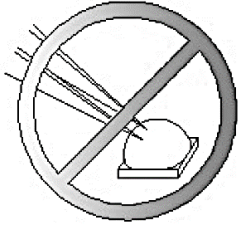

Do not poke the Led Lens with sharp object

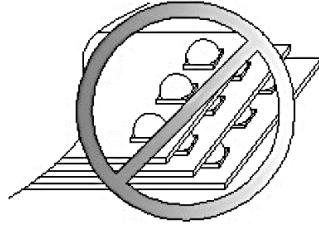

Do not stack assembled PCB

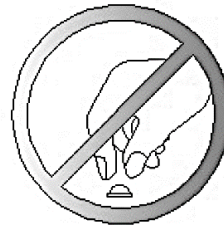

Do not hold the Led with hand



Do not press or push the Led Lens

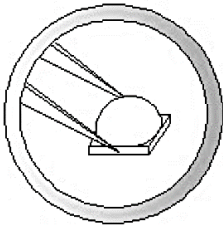

Hold the Led only by the substrate

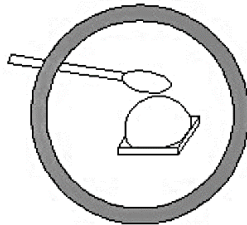

Clean the LED surface with cotton bud

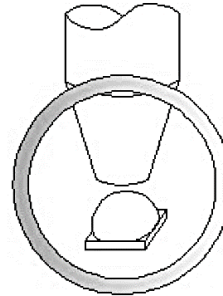

Use pick and place nozzle per recommendation in data sheet

- Do not touch LED lens with sharp objects such as tweezers.
- VOCs (Volatile Organic Compounds) emitted from materials used in the construction of fixtures, the organic gas is irradiated by the UVC light source, it may cause yellowing reactions inside and outside of the LED, and reducing the UVC light output.
- The high-intensity deep ultraviolet light emitted by the LED will damage the eyes and skin, please do not look directly at the light source, and it is recommended to wear protective equipment.
- The drive circuit must be designed to allow only forward voltage, reverse voltage may cause LED damage.
- It is recommended to use an anti-electrostatic soldering iron for soldering. The positive and negative electrodes of the lamp board shall not be welded at the same time to avoid circuit formation and damage the LED.
- Avoid stacking and pressurizing the LED when packaging.
- Avoid touching the electrodes while holding the lamp board to prevent any ESD/ electrostatic surge to the LED.