

THIS DRAWING IS UNPUBLISHED. RELEASED FOR PUBLICATION 20
 © COPYRIGHT 20 BY TYCO ELECTRONICS CORPORATION. ALL RIGHTS RESERVED.

LOC	DIST	REVISIONS					
FT	0	P	LTR	DESCRIPTION	DATE	DWN	APVD
		C		REVISED PER 063B-0326-01	23JUL2001	EZ	DB
		D		REVISED EC 063B-0191-03	30APR2003	SW	CR

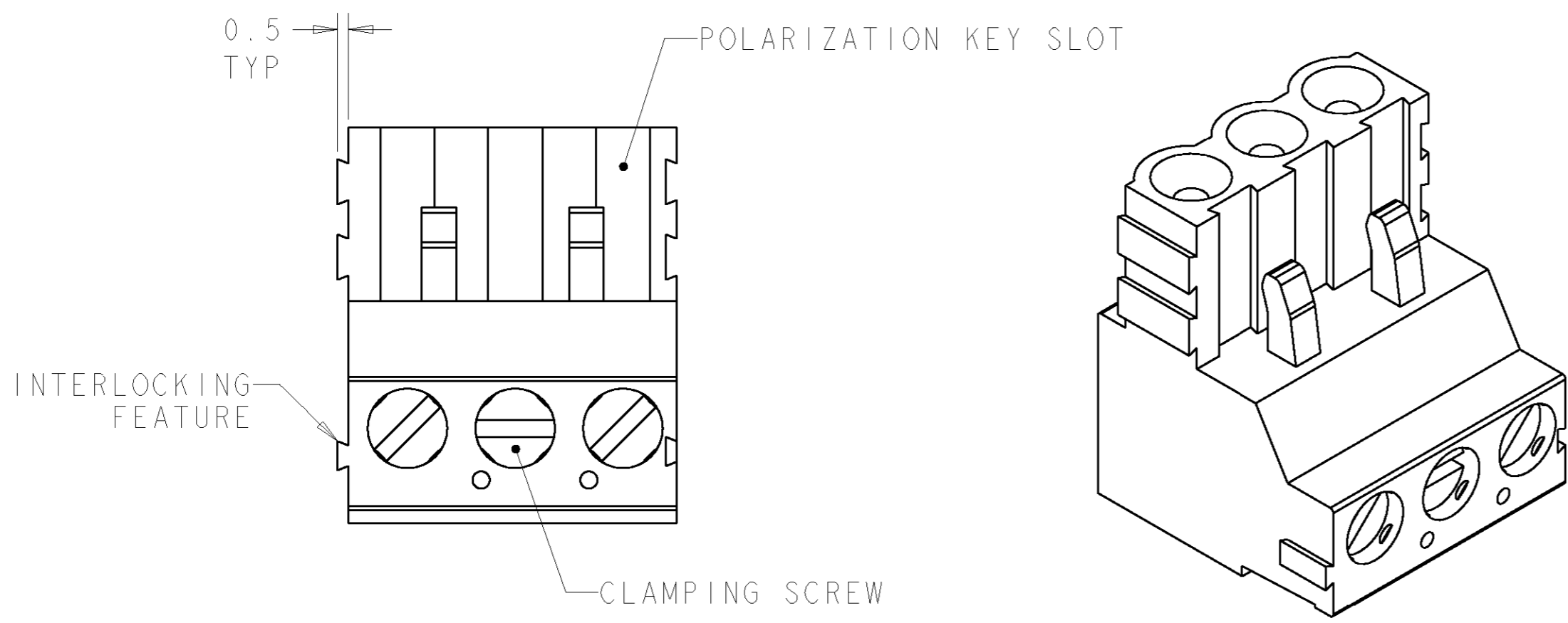

- 1. MATERIALS AND FINISH
 HOUSING: PA 6-6, UL 94-V0, COLOR GREEN.
 CLAMP: BRASS, NICKEL PLATED.
 CONTACT SPRING: PHOSPHOR BRONZE, TIN PLATED.
 CLAMPING SCREW: M3, BRASS, NICKEL PLATED.
- 2. END-TO-END STACKABLE W/INTERLOCK WITHOUT LOSS OF CENTERLINE SPACING.
- 3. WIRE SIZE RANGE
 SOLID WIRE: 0,03-2,5mm (13 AWG).
 STRANDED WIRE: 0,03-1,5mm (15 AWG).
- 4. RECOGNIZED UNDER THE COMPONENT PROGRAM OF UNDERWRITERS LABORATORIES INC. FILE N° E60677
- 5. IMQ CERTIFICATE WITH SURVEILLANCE IN CONFORMITY WITH IEC 998-1/998-2-1.
- 6. NOT CUMULATIVE TOLERANCE.
- 7. CHARACTERS INK STAMPED WHITE.

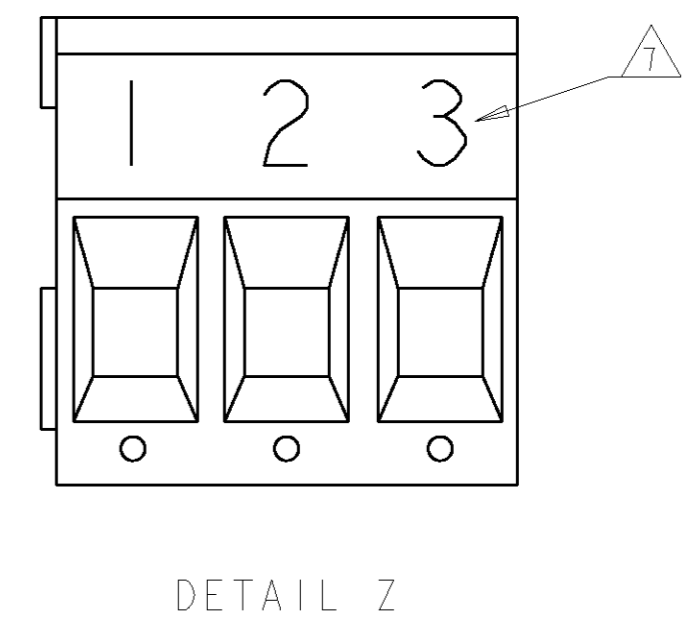
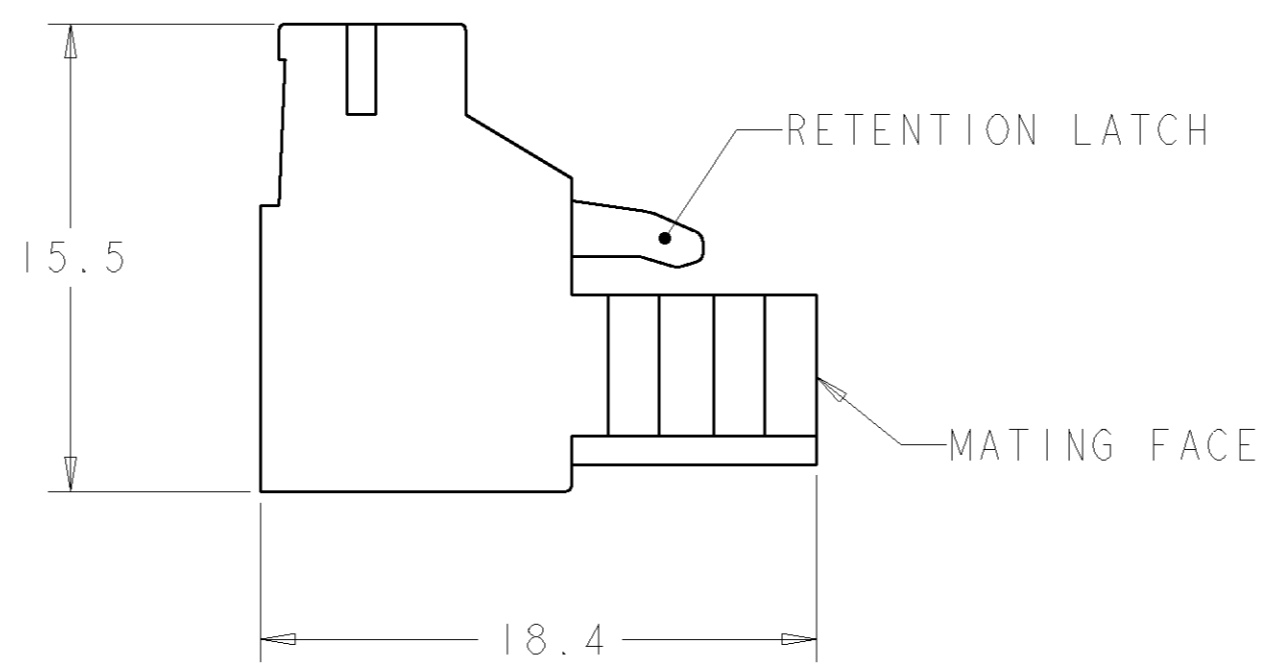
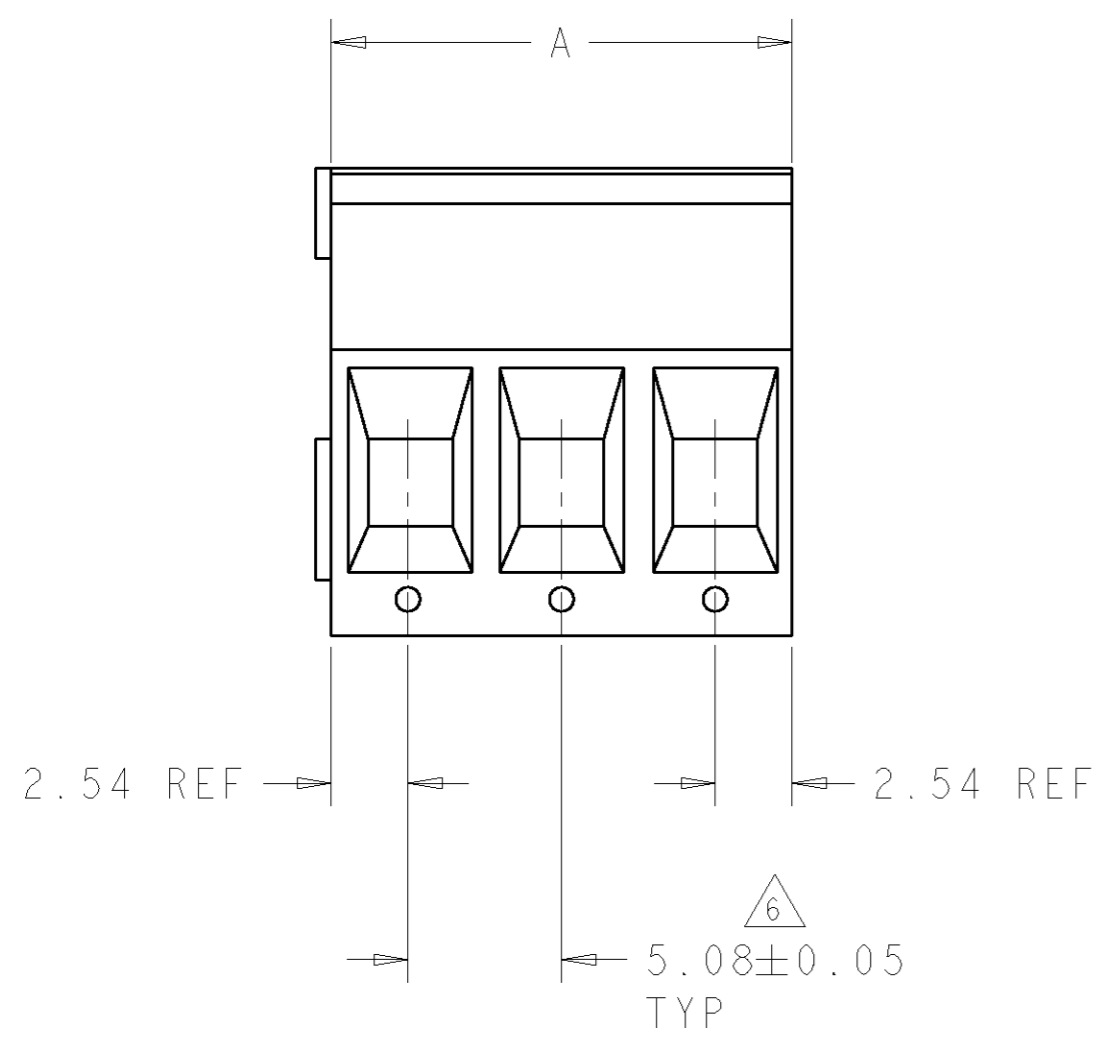

DETAIL Z	15.24	3	282807-5
-	20.32	4	282807-4
-	15.24	3	282807-3
-	10.16	2	282807-2
MARKING	L	NO OF POSN	PART NUMBER

THIS DRAWING IS A CONTROLLED DOCUMENT FOR TYCO ELECTRONICS CORPORATION IT IS SUBJECT TO CHANGE AND THE CONTROLLING ENGINEERING ORGANIZATION SHOULD BE CONTACTED FOR THE LATEST REVISION.		DWN 23 JUL 2001 E. ZANOLINI CHK 23 JUL 2001 D. BIEVENOUR APVD 23 JUL 2001 D. BIEVENOUR	BUCHANAN Tyco Electronics Harrisburg, PA 17105-3608
DIMENSIONS: mm 	TOLERANCES UNLESS OTHERWISE SPECIFIED: 0 PLC ±.2 1 PLC ±.2 2 PLC ±.25 3 PLC ±.25 4 PLC ±.2 ANGLES ±2 FINISH	PRODUCT SPEC 108-20166 APPLICATION SPEC 114-20079 WEIGHT -	NAME TERMINAL BLOCK PLUG STACKING W/INTERLOCK, 5.08mm PITCH
MATERIAL		SIZE A2 CAGE CODE 00779 DRAWING NO. G-282807	RESTRICTED TO -
CUSTOMER DRAWING		SCALE 3:1	SHEET 1 OF 1 REV D