

CEZ6R40SL-HF

N-Channel
RoHS Device
Halogen Free



Features

- Super high density cell design for extremely low $R_{DS(ON)}$.
- High power and current handling capability.
- Surface mount package.

Mechanical data

- Case: P-PAK 5x6, molded plastic.
- Mounting position: Any.

Circuit Diagram

- G : Gate
- S : Source
- D : Drain

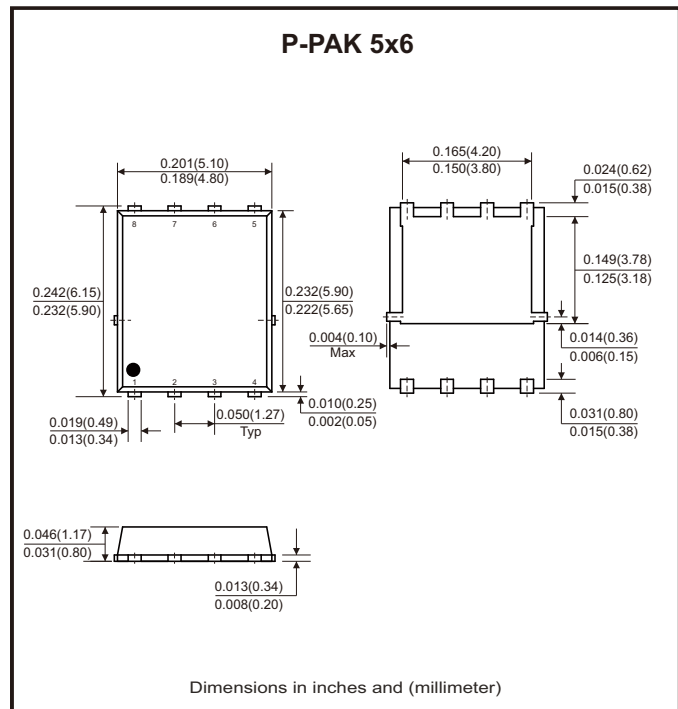
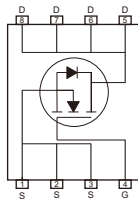

Maximum Ratings (at $T_c=25^\circ\text{C}$ unless otherwise noted)

Parameter	Symbol	Value	Unit
Drain-source voltage	V_{DS}	65	V
Gate-source voltage	V_{GS}	± 20	V
Drain Current-Continuous	$I_D @ R_{\theta JC}$	93	A
	$I_D @ R_{\theta JA}$	27	
Drain current-pulsed (Note 1)	$I_{DM} @ R_{\theta JC}$	372	A
	$I_{DM} @ R_{\theta JA}$	108	
Maximum power dissipation	P_D	73	W
Single pulse avalanche energy (Note 5)	E_{AS}	250	mJ
Single pulse avalanche current (Note 5)	I_{AS}	10	A
Operating and storage temperature range	T_J, T_{STG}	-55 to +150	$^\circ\text{C}$
Thermal resistance, junction to case	$R_{\theta JC}$	1.7	$^\circ\text{C/W}$
Thermal resistance, junction to ambient (Note 2)	$R_{\theta JA}$	20	$^\circ\text{C/W}$

Electrical Characteristics (at $T_c=25^\circ\text{C}$ unless otherwise noted)

Parameter	Symbol	Conditions	Min	Typ	Max	Unit
Off Characteristics						
Drain-source breakdown voltage	BV_{DSS}	$V_{GS} = 0V, I_D = 250\mu A$	65			V
Zero gate voltage drain current	I_{DSS}	$V_{DS} = 65V, V_{GS} = 0V$			1	μA
Gate body leakage current, forward	I_{GSSF}	$V_{GS} = 20V, V_{DS} = 0V$			100	nA
Gate body leakage current, reverse	I_{GSSR}	$V_{GS} = -20V, V_{DS} = 0V$			-100	
On Characteristics (Note 3)						
Gate threshold voltage	$V_{GS(th)}$	$V_{GS} = V_{DS}, I_D = 250\mu A$	1		3	V
Static drain-source on-resistance	$R_{DS(on)}$	$V_{GS} = 10V, I_D = 20A$		3.6	4.5	m Ω
		$V_{GS} = 4.5V, I_D = 15A$		5.7	7.4	
Dynamic Characteristics (Note 4)						
Input capacitance	C_{iss}	$V_{DS} = 30V, V_{GS} = 0V, f = 1MHz$		1790		pF
Output capacitance	C_{oss}			725		
Reverse transfer capacitance	C_{rss}			15		
Switching Characteristics (Note 4)						
Turn-on delay time	$t_{d(on)}$	$V_{DD} = 30V, I_D = 20A$ $V_{GS} = 10V, R_{GEN} = 25\Omega$		22		nS
Turn-on rise time	t_r			28		
Turn-off delay time	$t_{d(off)}$			143		
Turn-off fall time	t_f			90		
Total gate charge	Q_g	$V_{DS} = 30V, I_D = 20A, V_{GS} = 4.5V$		26		nC
Gate-source charge	Q_{gs}			4		
Gate-drain charge	Q_{gd}			15		
Drain-Source-Diode Characteristics and Maximum Ratings						
Drain-source diode forward current(Note 2)	I_S				60	A
Drain-source diode forward voltage(Note 3)	V_{SD}	$V_{GS} = 0V, I_S = 20A$			1.2	V

- Notes: 1. Repetitive rating: pulse width limited by maximum junction temperature.
 2. Surface mounted on FR4 board, $t \leq 10$ sec.
 3. Pulse test: pulse width $\leq 300\mu s$, duty cycle $\leq 2\%$.
 4. Guaranteed by design, not subject to production testing.
 5. $L = 5mH, I_{AS} = 10A, V_{DD} = 24V, R_G = 25\Omega$, starting $T_J = 25^\circ\text{C}$.

Rating and Characteristic Curves (CEZ6R40SL-HF)

Fig.1 - Output Characteristics

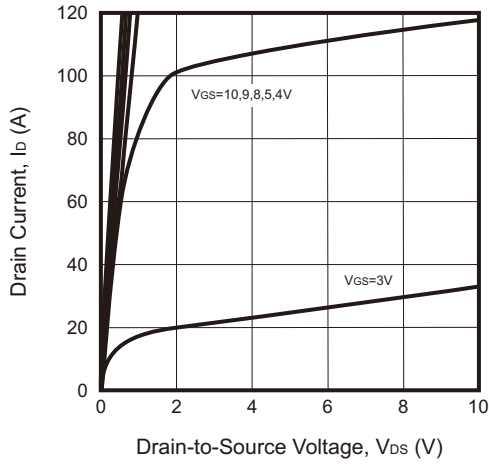

Fig.2 - Transfer Characteristics

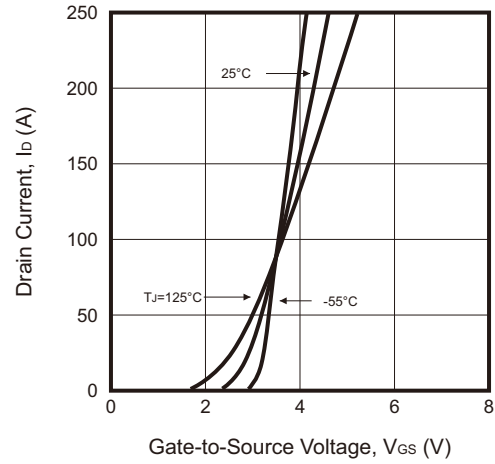

Fig.3 - Capacitance

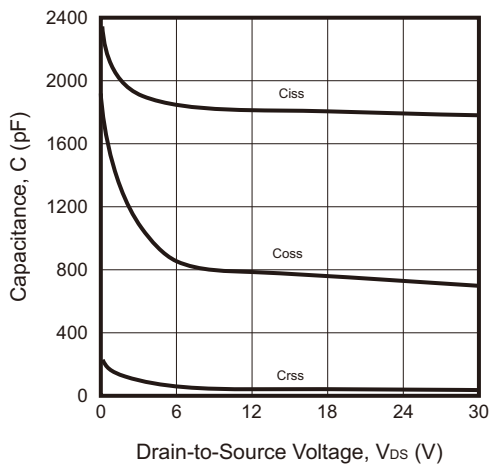

Fig.4 - On-Resistance Variation with Temperature

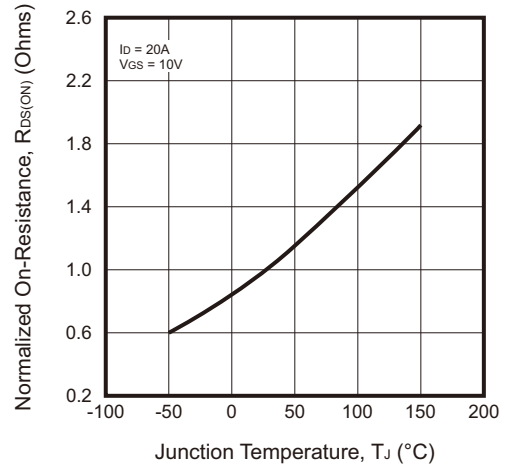

Fig.5 - Gate Threshold Variation with Temperature

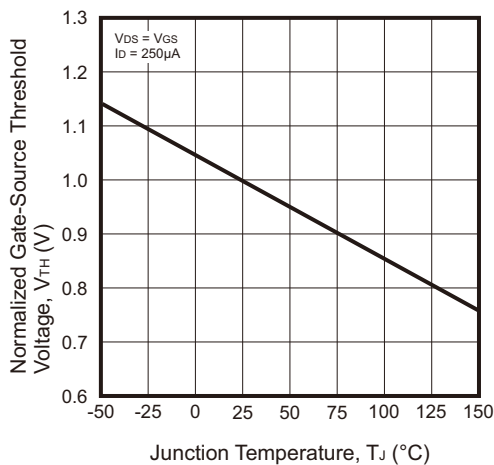
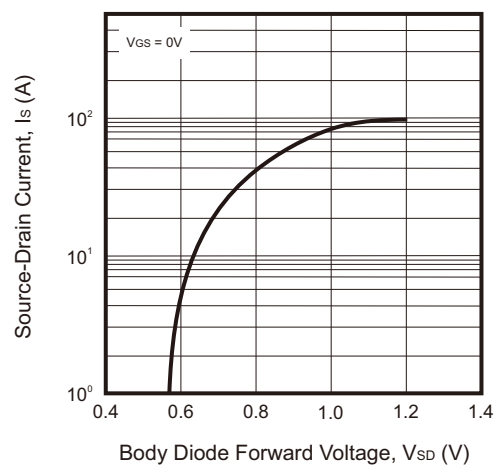

Fig.6 - Body Diode Forward Voltage Variation with Source Current



Rating and Characteristic Curves (CEZ6R40SL-HF)

Fig.7 - Gate Charge

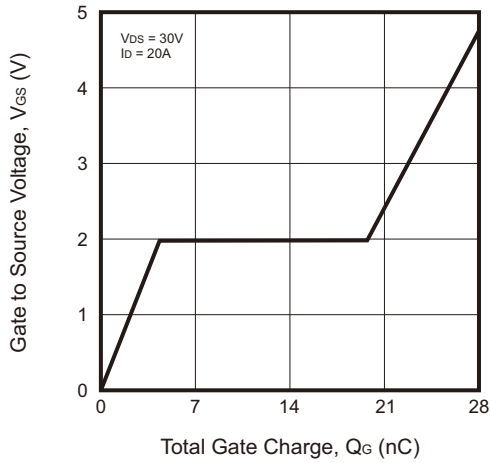

Fig.8 - Maximum Safe Operating Area

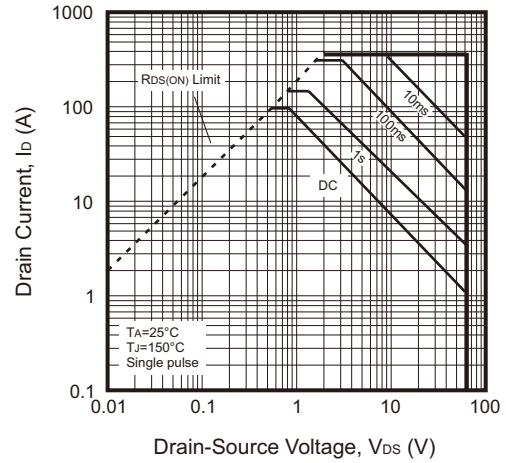
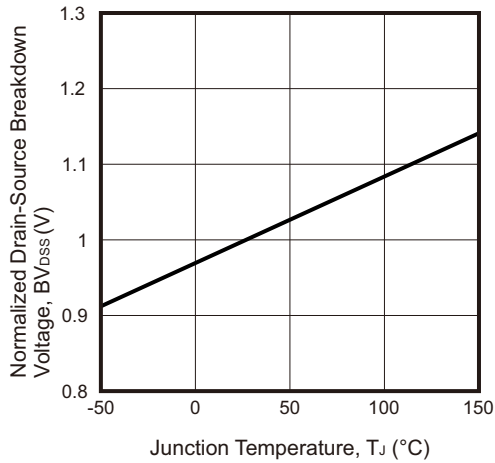
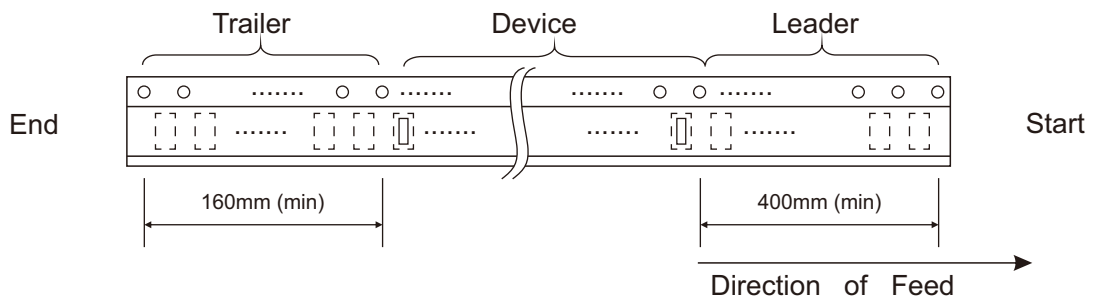
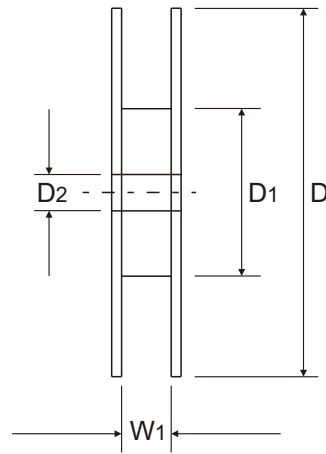
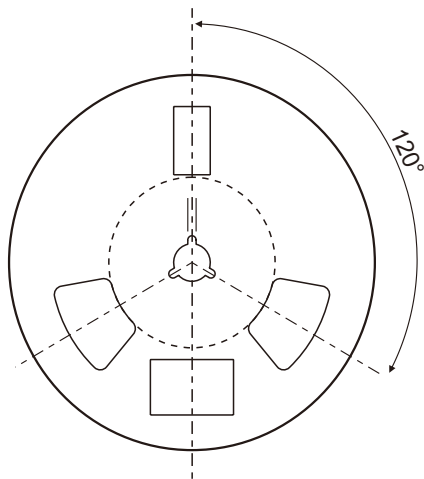
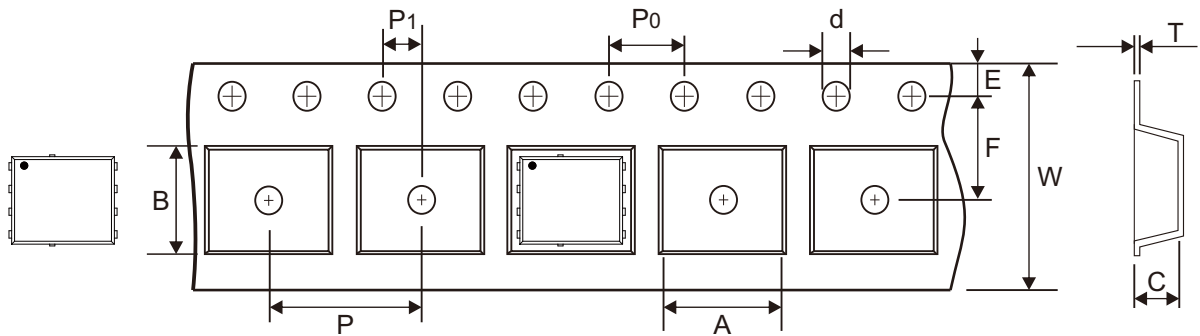

Fig.9 - Breakdown Voltage Variation vs Temperature



Reel Taping Specification



P-PAK 5x6	SYMBOL	A	B	C	d	D	D1	D2
	(mm)	6.50 ± 0.10	5.28 ± 0.10	2.00 ± 0.10	1.50 + 0.10	330 ± 2.00	100 ± 1.00	13.00 + 0.50 - 0.20
	(inch)	0.256 ± 0.004	0.208 ± 0.004	0.079 ± 0.004	0.059 + 0.004	12.992 ± 0.079	3.937 ± 0.039	0.512 + 0.020 - 0.008

P-PAK 5x6	SYMBOL	E	F	P	P0	P1	T	W	W1
	(mm)	1.75 ± 0.10	5.50 ± 0.05	8.00 ± 0.10	4.00 ± 0.10	2.00 ± 0.05	0.25 ± 0.02	12.00 + 0.30 - 0.10	12.4 Min
	(inch)	0.069 ± 0.004	0.217 ± 0.002	0.315 ± 0.004	0.157 ± 0.004	0.079 ± 0.002	0.010 ± 0.001	0.472 + 0.012 - 0.004	0.488 Min

Company reserves the right to improve product design , functions and reliability without notice. REV:A

Marking Code

Part Number	Marking Code
CEZ6R40SL-HF	CEZ6R40SL XXXXX

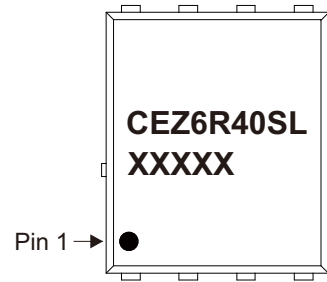

xxxxx = Control code

Suggested P.C.B. PAD Layout

SIZE	P-PAK 5x6	
	(mm)	(inch)
A	0.50	0.020
B	0.80	0.031
C	0.55	0.022
D	3.65	0.144
E	4.50	0.177
F	0.77	0.030
G	1.27	0.050
H	6.15	0.242

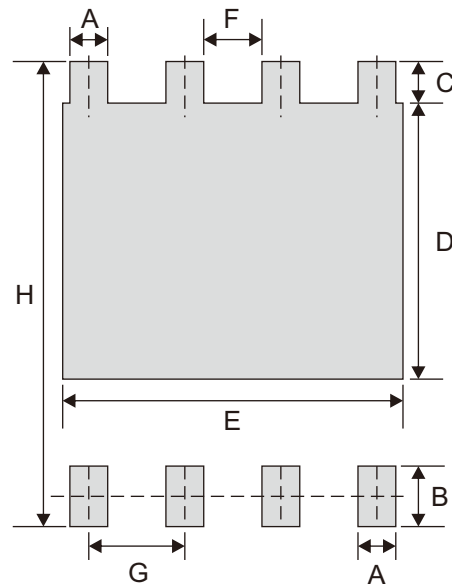

Standard Packaging

Case Type	REEL PACK	
	REEL (pcs)	Reel Size (inch)
P-PAK 5x6	2,500	13