

74HC240-Q100; 74HCT240-Q100

Octal buffer/line driver; 3-state; inverting

Rev. 1 — 30 July 2012

Product data sheet

1. General description

The 74HC240-Q100; 74HCT240-Q100 is a high-speed Si-gate CMOS device and is pin compatible with Low-Power Schottky TTL (LSTTL).

The 74HC240-Q100; 74HCT240-Q100 is a dual octal inverting buffer/line driver with 3-state outputs. The 3-state outputs are controlled by the output enable inputs $\overline{1OE}$ and $2OE$. A HIGH on nOE causes the outputs to assume a high impedance OFF-state.

This product has been qualified to the Automotive Electronics Council (AEC) standard Q100 (Grade 1) and is suitable for use in automotive applications.

2. Features and benefits

- Automotive product qualification in accordance with AEC-Q100 (Grade 1)
 - ◆ Specified from $-40\text{ }^{\circ}\text{C}$ to $+85\text{ }^{\circ}\text{C}$ and from $-40\text{ }^{\circ}\text{C}$ to $+125\text{ }^{\circ}\text{C}$
- Inverting 3-state outputs
- Multiple package options
- Complies with JEDEC standard no. 7 A
- ESD protection:
 - ◆ MIL-STD-883, method 3015 exceeds 2000 V
 - ◆ HBM JESD22-A114F exceeds 2000 V
 - ◆ MM JESD22-A115-A exceeds 200 V (C = 200 pF, R = 0 Ω)

3. Ordering information

Table 1. Ordering information

Type number	Package			
	Temperature range	Name	Description	Version
74HC240D-Q100 74HCT240D-Q100	$-40\text{ }^{\circ}\text{C}$ to $+125\text{ }^{\circ}\text{C}$	SO20	plastic small outline package; 20 leads; body width 7.5 mm	SOT163-1
74HC240PW-Q100 74HCT240PW-Q100	$-40\text{ }^{\circ}\text{C}$ to $+125\text{ }^{\circ}\text{C}$	TSSOP20	plastic thin shrink small outline package; 20 leads; body width 4.4 mm	SOT360-1
74HC240BQ-Q100 74HCT240BQ-Q100	$-40\text{ }^{\circ}\text{C}$ to $+125\text{ }^{\circ}\text{C}$	DHVQFN20	plastic dual-in-line compatible thermal enhanced very thin quad flat package; no leads; 20 terminals; body $2.5 \times 4.5 \times 0.85\text{ mm}$	SOT764-1

4. Functional diagram

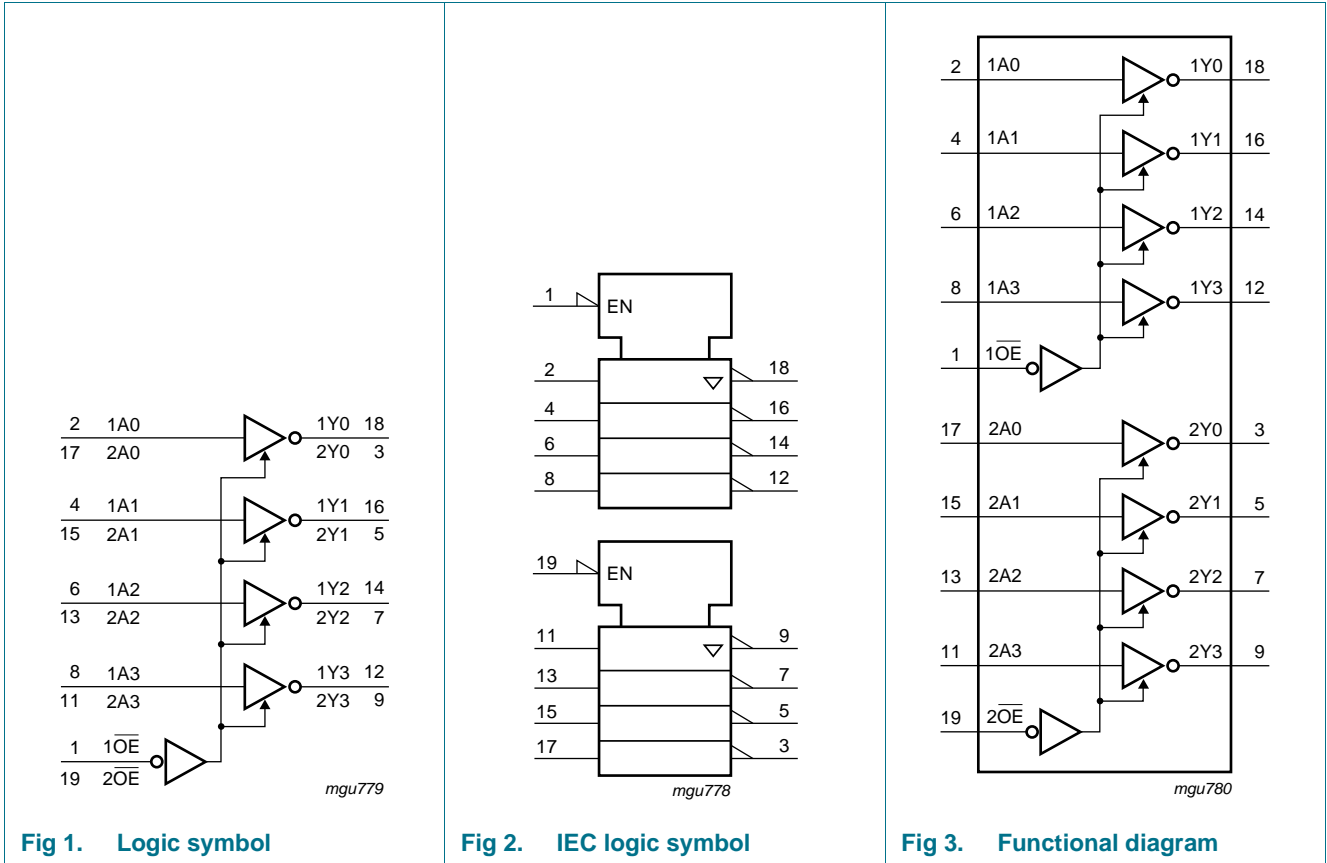

5. Pinning information

5.1 Pinning

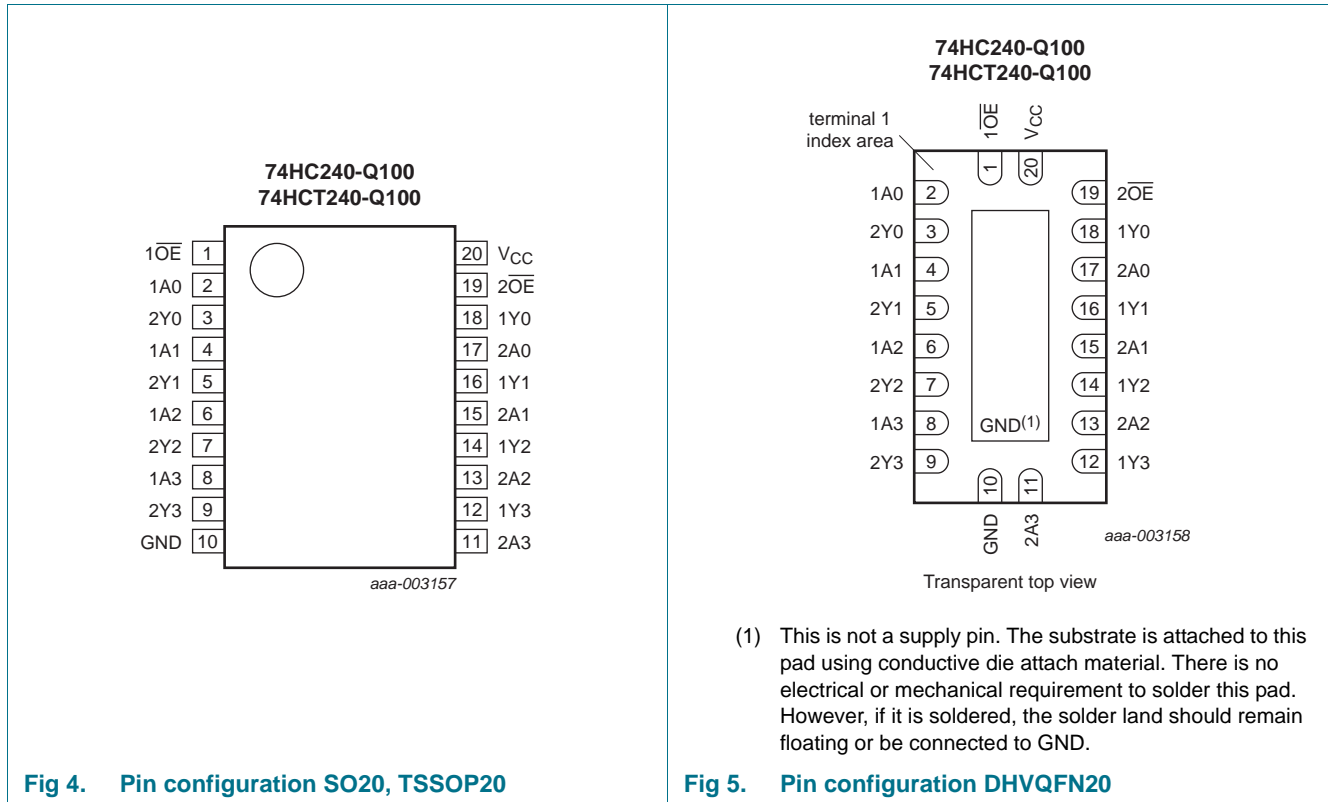

Fig 4. Pin configuration SO20, TSSOP20

Fig 5. Pin configuration DHVQFN20

5.2 Pin description

Table 2. Pin description

Symbol	Pin	Description
10 \overline{OE} , 20 \overline{OE}	1, 19	output enable input (active LOW)
1A0, 1A1, 1A2, 1A3	2, 4, 6, 8	data input
2Y0, 2Y1, 2Y2, 2Y3	3, 5, 7, 9	bus output
GND	10	ground (0 V)
2A0, 2A1, 2A2, 2A3	17, 15, 13, 11	data input
1Y0, 1Y1, 1Y2, 1Y3	18, 16, 14, 12	bus output
V _{CC}	20	supply voltage

6. Functional description

Table 3. Function table^[1]

Input		Output
nOE	nAn	nYn
L	L	H
L	H	L
H	X	Z

[1] H = HIGH voltage level; L = LOW voltage level; X = don't care; Z = high-impedance OFF-state.

7. Limiting values

Table 4. Limiting values

In accordance with the Absolute Maximum Rating System (IEC 60134). Voltages are referenced to GND (ground = 0 V).

Symbol	Parameter	Conditions	Min	Max	Unit
V_{CC}	supply voltage		-0.5	+7	V
I_{IK}	input clamping current	$V_I < -0.5\text{ V}$ or $V_I > V_{CC} + 0.5\text{ V}$	-	± 20	mA
I_{OK}	output clamping current	$V_O < -0.5\text{ V}$ or $V_O > V_{CC} + 0.5\text{ V}$	-	± 20	mA
I_O	output current	$-0.5\text{ V} < V_O < V_{CC} + 0.5\text{ V}$	-	± 35	mA
I_{CC}	supply current		-	70	mA
I_{GND}	ground current		-70	-	mA
T_{stg}	storage temperature		-65	+150	°C
P_{tot}	total power dissipation		[1] -	500	mW

[1] For SO20 packages: above 70 °C, P_{tot} derates linearly with 8 mW/K.
 For TSSOP20 package: above 60 °C, P_{tot} derates linearly with 5.5 mW/K.
 For DHVQFN20 packages: above 60 °C, P_{tot} derates linearly with 4.5 mW/K.

8. Recommended operating conditions

Table 5. Recommended operating conditions

Symbol	Parameter	Conditions	Min	Typ	Max	Unit
74HC240-Q100						
V_{CC}	supply voltage		2.0	5.0	6.0	V
V_I	input voltage		0	-	V_{CC}	V
V_O	output voltage		0	-	V_{CC}	V
$\Delta t/\Delta V$	input transition rise and fall rate	$V_{CC} = 2.0\text{ V}$	-	-	625	ns/V
		$V_{CC} = 4.5\text{ V}$	-	1.67	139	ns/V
		$V_{CC} = 6.0\text{ V}$	-	-	83	ns/V
T_{amb}	ambient temperature		-40	-	+125	°C

Table 5. Recommended operating conditions ...continued

Symbol	Parameter	Conditions	Min	Typ	Max	Unit
74HCT240-Q100						
V_{CC}	supply voltage		4.5	5.0	5.5	V
V_I	input voltage		0	-	V_{CC}	V
V_O	output voltage		0	-	V_{CC}	V
$\Delta t/\Delta V$	input transition rise and fall rate	$V_{CC} = 4.5\text{ V}$	-	1.67	139	ns/V
T_{amb}	ambient temperature		-40	-	+125	°C

9. Static characteristics

Table 6. Static characteristics

At recommended operating conditions; voltages are referenced to GND (ground = 0 V).

Symbol	Parameter	Conditions	25 °C			-40 °C to +85 °C		-40 °C to +125 °C		Unit
			Min	Typ	Max	Min	Max	Min	Max	
74HC240-Q100										
V_{IH}	HIGH-level input voltage	$V_{CC} = 2.0\text{ V}$	1.5	1.2	-	1.5	-	1.5	-	V
		$V_{CC} = 4.5\text{ V}$	3.15	2.4	-	3.15	-	3.15	-	V
		$V_{CC} = 6.0\text{ V}$	4.2	3.2	-	4.2	-	4.2	-	V
V_{IL}	LOW-level input voltage	$V_{CC} = 2.0\text{ V}$	-	0.8	0.5	-	0.5	-	0.5	V
		$V_{CC} = 4.5\text{ V}$	-	2.1	1.35	-	1.35	-	1.35	V
		$V_{CC} = 6.0\text{ V}$	-	2.8	1.8	-	1.8	-	1.8	V
V_{OH}	HIGH-level output voltage	$V_I = V_{IH}$ or V_{IL}								
		$I_O = -20\text{ }\mu\text{A}$; $V_{CC} = 2.0\text{ V}$	1.9	2.0	-	1.9	-	1.9	-	V
		$I_O = -20\text{ }\mu\text{A}$; $V_{CC} = 4.5\text{ V}$	4.4	4.5	-	4.4	-	4.4	-	V
		$I_O = -20\text{ }\mu\text{A}$; $V_{CC} = 6.0\text{ V}$	5.9	6.0	-	5.9	-	5.9	-	V
		$I_O = -6.0\text{ mA}$; $V_{CC} = 4.5\text{ V}$	3.98	4.32	-	3.84	-	3.7	-	V
		$I_O = -7.8\text{ mA}$; $V_{CC} = 6.0\text{ V}$	5.48	5.81	-	5.34	-	5.2	-	V
V_{OL}	LOW-level output voltage	$V_I = V_{IH}$ or V_{IL}								
		$I_O = 20\text{ }\mu\text{A}$; $V_{CC} = 2.0\text{ V}$	-	0	0.1	-	0.1	-	0.1	V
		$I_O = 20\text{ }\mu\text{A}$; $V_{CC} = 4.5\text{ V}$	-	0	0.1	-	0.1	-	0.1	V
		$I_O = 20\text{ }\mu\text{A}$; $V_{CC} = 6.0\text{ V}$	-	0	0.1	-	0.1	-	0.1	V
		$I_O = 6.0\text{ mA}$; $V_{CC} = 4.5\text{ V}$	-	0.15	0.26	-	0.33	-	0.4	V
		$I_O = 7.8\text{ mA}$; $V_{CC} = 6.0\text{ V}$	-	0.16	0.26	-	0.33	-	0.4	V
I_I	input leakage current	$V_I = V_{CC}$ or GND; $V_{CC} = 6.0\text{ V}$	-	-	± 0.1	-	± 1.0	-	± 1.0	μA
I_{OZ}	OFF-state output current	per input pin; $V_I = V_{IH}$ or V_{IL} ; $V_O = V_{CC}$ or GND; other inputs at V_{CC} or GND; $V_{CC} = 6.0\text{ V}$; $I_O = 0\text{ A}$	-	-	± 0.5	-	± 5.0	-	± 10	μA
I_{CC}	supply current	$V_I = V_{CC}$ or GND; $I_O = 0\text{ A}$; $V_{CC} = 6.0\text{ V}$	-	-	8.0	-	80	-	160	μA
C_I	input capacitance		-	3.5	-	-	-	-	-	pF

Table 6. Static characteristics ...continued

At recommended operating conditions; voltages are referenced to GND (ground = 0 V).

Symbol	Parameter	Conditions	25 °C			-40 °C to +85 °C		-40 °C to +125 °C		Unit
			Min	Typ	Max	Min	Max	Min	Max	
74HCT240-Q100										
V _{IH}	HIGH-level input voltage	V _{CC} = 4.5 V to 5.5 V	2.0	1.6	-	2.0	-	2.0	-	V
V _{IL}	LOW-level input voltage	V _{CC} = 4.5 V to 5.5 V	-	1.2	0.8	-	0.8	-	0.8	V
V _{OH}	HIGH-level output voltage	V _I = V _{IH} or V _{IL} ; V _{CC} = 4.5 V								
		I _O = -20 μA	4.4	4.5	-	4.4	-	4.4	-	V
		I _O = -6 mA	3.98	4.32	-	3.84	-	3.7	-	V
V _{OL}	LOW-level output voltage	V _I = V _{IH} or V _{IL} ; V _{CC} = 4.5 V								
		I _O = 20 μA	-	0	0.1	-	0.1	-	0.1	V
		I _O = 6.0 mA	-	0.16	0.26	-	0.33	-	0.4	V
I _I	input leakage current	V _I = V _{CC} or GND; V _{CC} = 5.5 V	-	-	±0.1	-	±1.0	-	±1.0	μA
I _{OZ}	OFF-state output current	per input pin; V _I = V _{IH} or V _{IL} ; V _O = V _{CC} or GND; other inputs at V _{CC} or GND; V _{CC} = 5.5 V; I _O = 0 A	-	-	±0.5	-	±5.0	-	±10	μA
I _{CC}	supply current	V _I = V _{CC} or GND; V _{CC} = 5.5 V; I _O = 0 A	-	-	8.0	-	80	-	160	μA
ΔI _{CC}	additional supply current	per input pin; V _I = V _{CC} - 2.1 V; other inputs at V _{CC} or GND; V _{CC} = 4.5 V to 5.5 V; I _O = 0 A								
		nAn or inputs	-	150	540	-	675	-	735	μA
		nOE input	-	70	252	-	315	-	343	μA
C _I	input capacitance		-	3.5	-	-	-	-	-	pF

10. Dynamic characteristics

Table 7. Dynamic characteristicsGND = 0 V; for load circuit see [Figure 8](#).

Symbol	Parameter	Conditions	25 °C			-40 °C to +125 °C		Unit
			Min	Typ	Max	Max (85 °C)	Max (125 °C)	
74HC240-Q100								
t _{pd}	propagation delay	nAn to nYn; see Figure 6		[1]				
		V _{CC} = 2.0 V	-	30	100	125	150	ns
		V _{CC} = 4.5 V	-	11	20	25	30	ns
		V _{CC} = 5.0 V; C _L = 15 pF	-	9	-	-	-	ns
		V _{CC} = 6.0 V	-	9	17	21	26	ns

Table 7. Dynamic characteristics ...continuedGND = 0 V; for load circuit see [Figure 8](#).

Symbol	Parameter	Conditions	25 °C			-40 °C to +125 °C		Unit
			Min	Typ	Max	Max (85 °C)	Max (125 °C)	
t _{en}	enable time	n $\overline{\text{OE}}$ to nYn; see Figure 7 [2]						
		V _{CC} = 2.0 V	-	39	150	190	225	ns
		V _{CC} = 4.5 V	-	14	30	38	45	ns
		V _{CC} = 6.0 V	-	11	26	33	38	ns
t _{dis}	disable time	n $\overline{\text{OE}}$ to nYn or see Figure 7 [3]						
		V _{CC} = 2.0 V	-	41	150	190	225	ns
		V _{CC} = 4.5 V	-	15	30	38	45	ns
		V _{CC} = 6.0 V	-	12	26	33	38	ns
t _t	transition time	see Figure 6 [4]						
		V _{CC} = 2.0 V	-	14	60	75	90	ns
		V _{CC} = 4.5 V	-	5	12	15	18	ns
		V _{CC} = 6.0 V	-	4	10	13	15	ns
C _{PD}	power dissipation capacitance	per transceiver; V _I = GND to V _{CC} [5]	-	30	-	-	-	pF

74HCT240-Q100

t _{pd}	propagation delay	nAn to nYn; see Figure 6 [1]						
		V _{CC} = 4.5 V	-	11	20	25	30	ns
		V _{CC} = 5.0 V; C _L = 15 pF	-	9	-	-	-	ns
t _{en}	enable time	n $\overline{\text{OE}}$ to nYn; V _{CC} = 4.5 V; see Figure 7 [2]	-	13	30	38	45	ns
t _{dis}	disable time	n $\overline{\text{OE}}$ to nYn; V _{CC} = 4.5 V; see Figure 7 [3]	-	13	25	31	38	ns
t _t	transition time	V _{CC} = 4.5 V; see Figure 6 [4]	-	5	12	15	18	ns
C _{PD}	power dissipation capacitance	per transceiver; V _I = GND to V _{CC} - 1.5 V [5]	-	30	-	-	-	pF

[1] t_{pd} is the same as t_{PHL} and t_{PLH}.[2] t_{en} is the same as t_{PZH} and t_{PZL}.[3] t_{dis} is the same as t_{PHZ} and t_{PLZ}.[4] t_t is the same as t_{THL} and t_{TLH}.[5] C_{PD} is used to determine the dynamic power dissipation (P_D in μW):

$$P_D = C_{PD} \times V_{CC}^2 \times f_i \times N + \sum (C_L \times V_{CC}^2 \times f_o) \text{ where:}$$

f_i = input frequency in MHz;f_o = output frequency in MHz;C_L = output load capacitance in pF;V_{CC} = supply voltage in V;

N = number of inputs switching;

∑ (C_L × V_{CC}² × f_o) = sum of outputs.

11. Waveforms

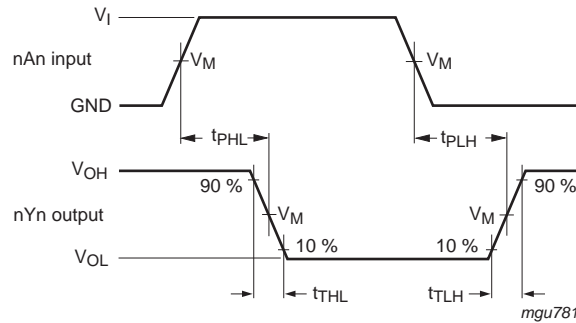

Measurement points are given in [Table 8](#).

V_{OL} and V_{OH} are typical voltage output levels that occur with the output load.

Fig 6. Input (nAn) to output (nYn) propagation delays and output transition times

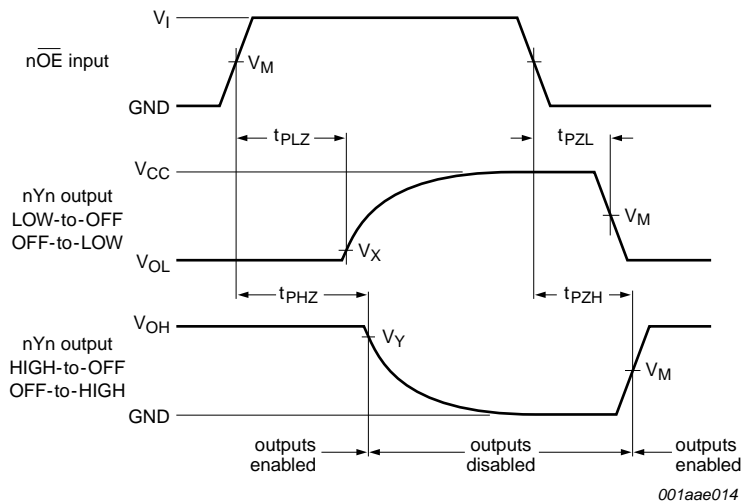

Measurement points are given in [Table 8](#).

V_{OL} and V_{OH} are typical voltage output levels that occur with the output load.

Fig 7. 3-state enable and disable times

Table 8. Measurement points

Type	Input	Output		
	V_M	V_M	V_X	V_Y
74HC240-Q100	$0.5 \times V_{CC}$	$0.5 \times V_{CC}$	$0.1 \times V_{CC}$	$0.9 \times V_{CC}$
74HCT240-Q100	1.3 V	1.3 V	$0.1 \times V_{CC}$	$0.9 \times V_{CC}$

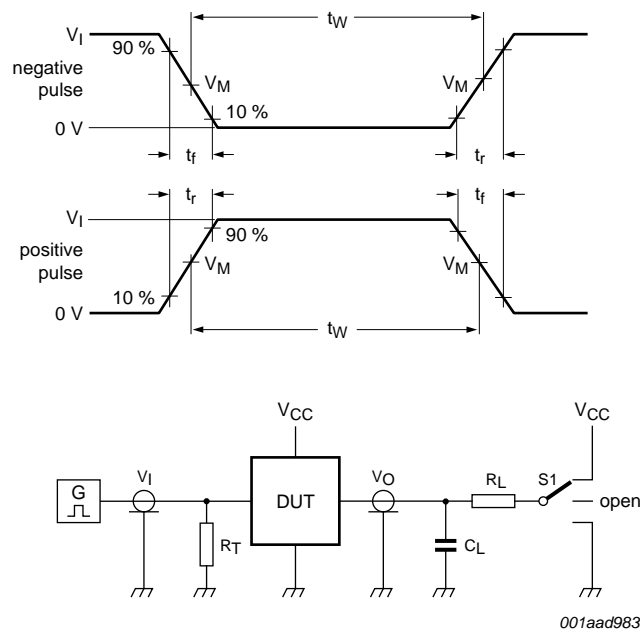

001aad983

Test data is given in [Table 9](#).

Definitions test circuit:

R_T = Termination resistance should be equal to output impedance Z_o of the pulse generator.

C_L = Load capacitance including jig and probe capacitance.

R_L = Load resistance.

S1 = Test selection switch.

Fig 8. Test circuit for measuring switching times

Table 9. Test data

Type	Input		Load		S1 position		
	V_I	t_r, t_f	C_L	R_L	t_{PHL}, t_{PLH}	t_{PZH}, t_{PHZ}	t_{PZL}, t_{PLZ}
74HC240-Q100	V_{CC}	6 ns	15 pF, 50 pF	1 k Ω	open	GND	V_{CC}
74HCT240-Q100	3 V	6 ns	15 pF, 50 pF	1 k Ω	open	GND	V_{CC}

12. Package outline

SO20: plastic small outline package; 20 leads; body width 7.5 mm

SOT163-1

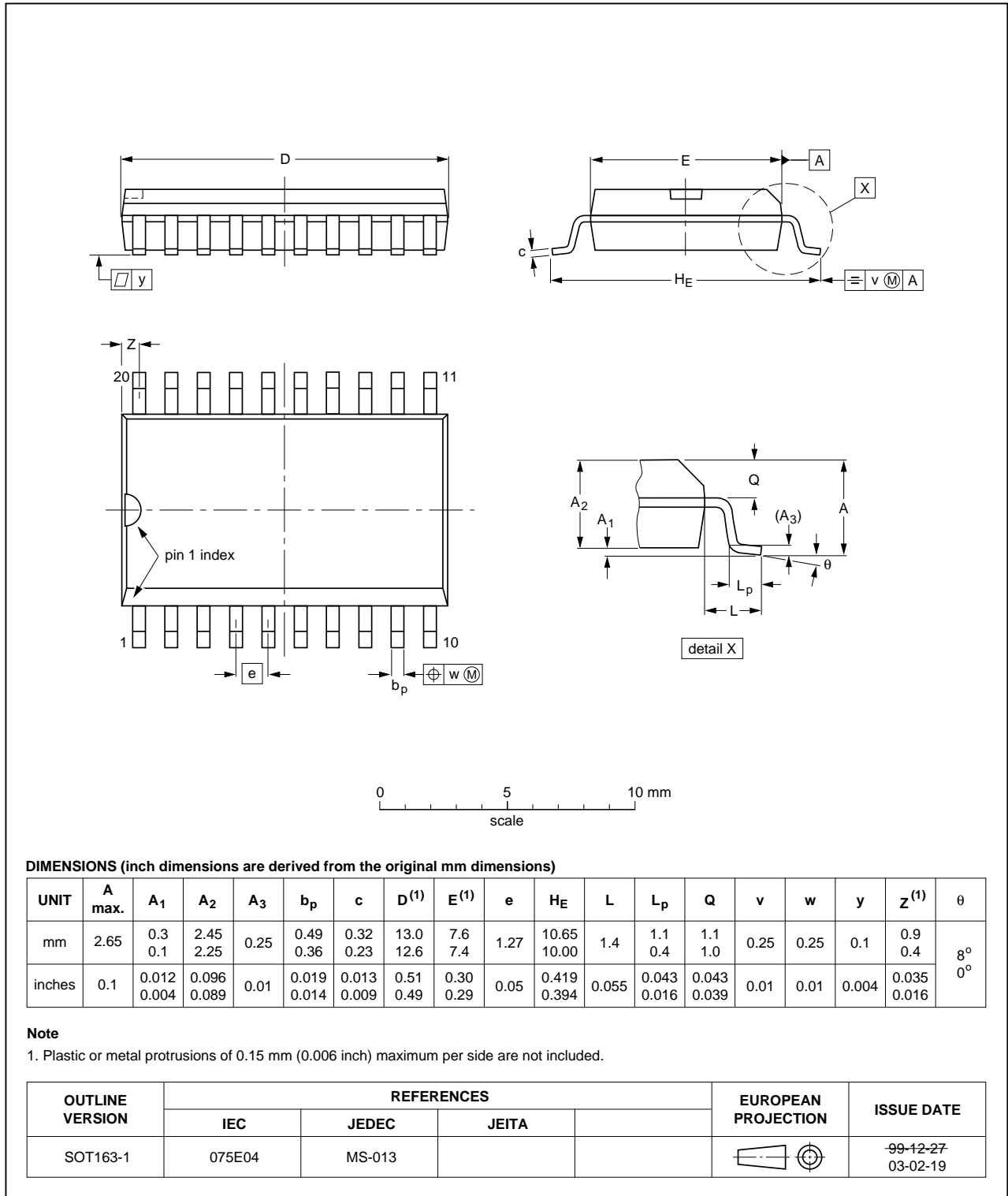

Fig 9. Package outline SOT163-1 (SO20)

TSSOP20: plastic thin shrink small outline package; 20 leads; body width 4.4 mm

SOT360-1

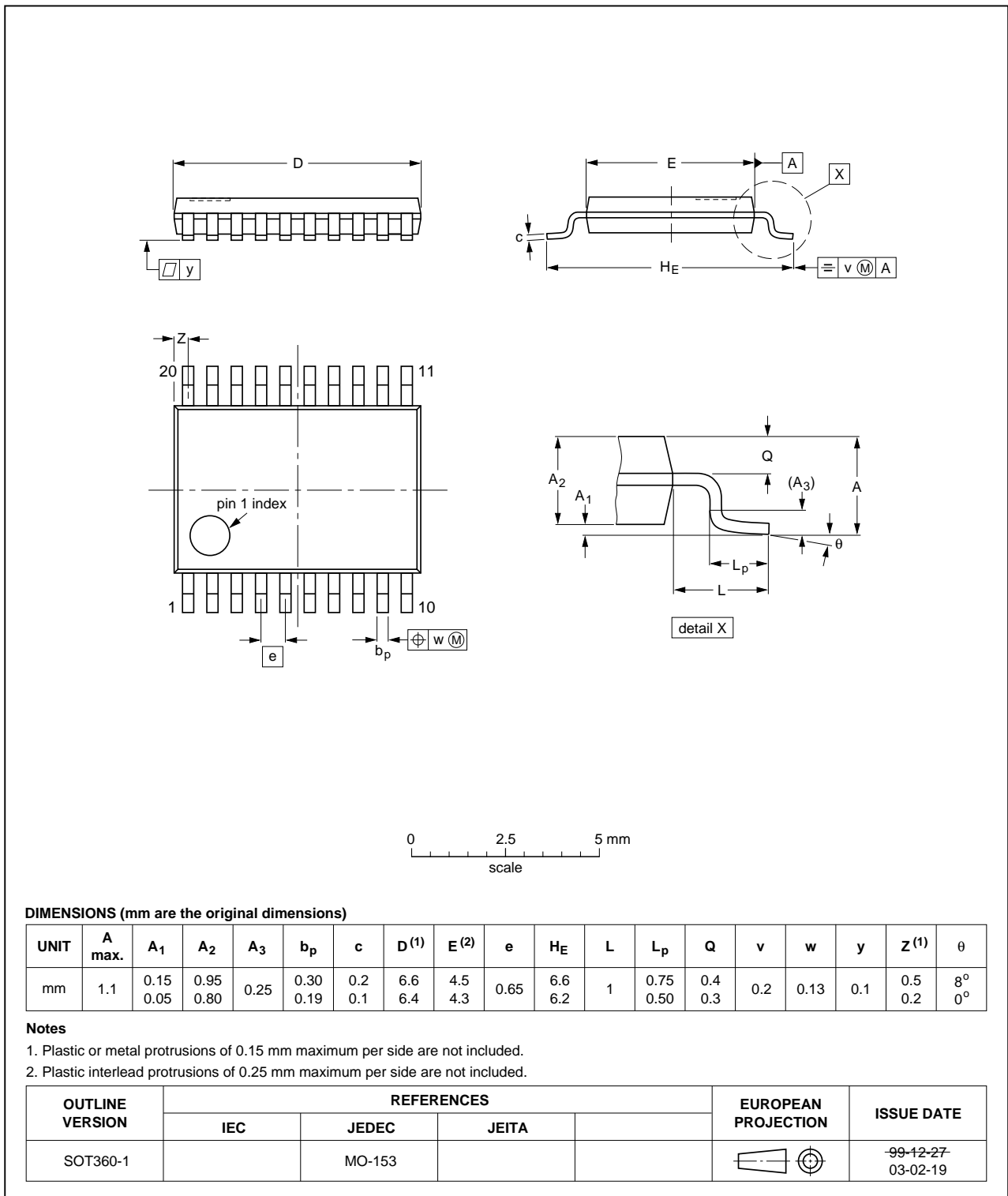

Fig 10. Package outline SOT360-1 (TSSOP20)

DHVQFN20: plastic dual in-line compatible thermal enhanced very thin quad flat package; no leads; 20 terminals; body 2.5 x 4.5 x 0.85 mm

SOT764-1

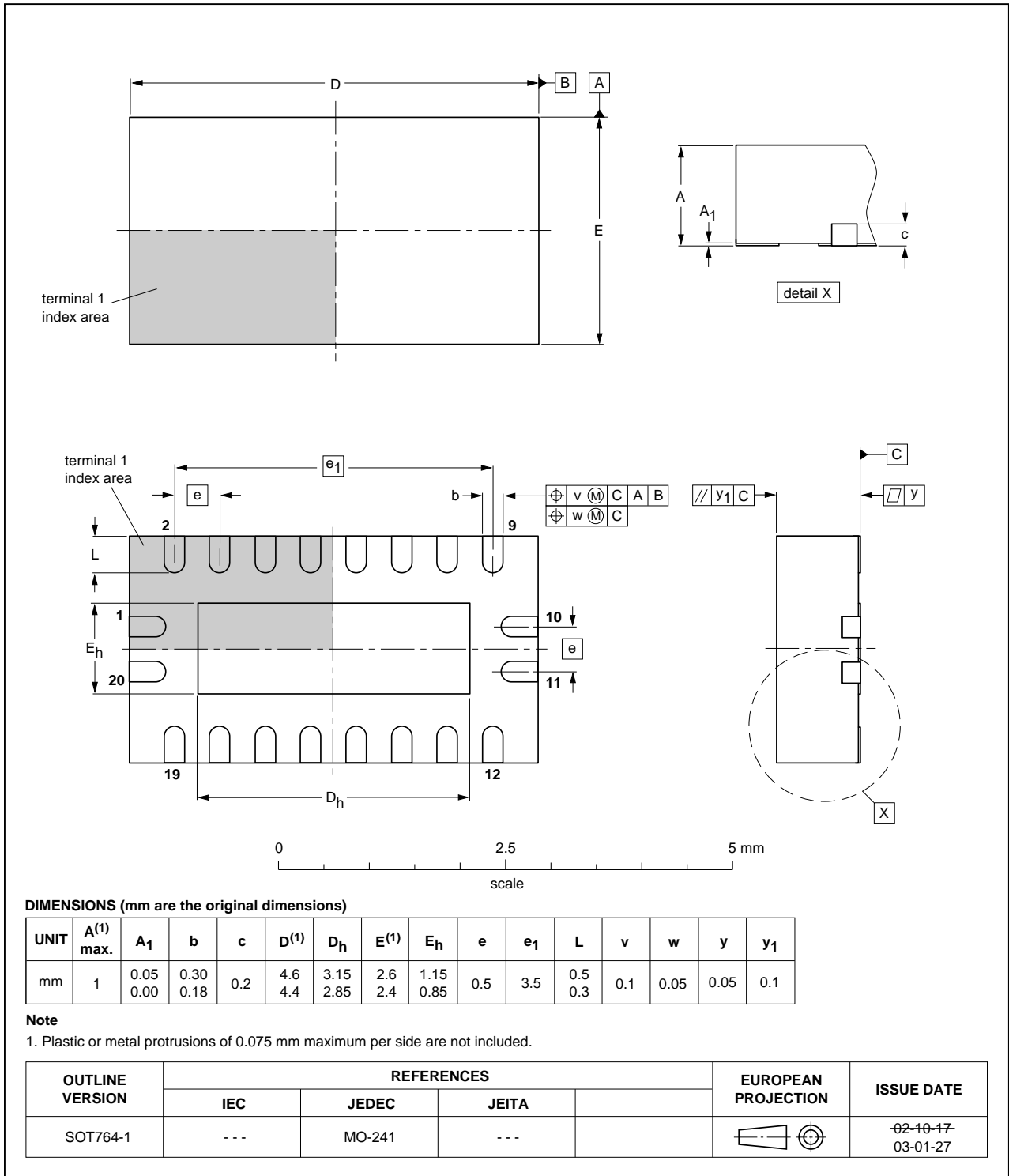

Fig 11. Package outline SOT764-1 (DHVQFN20)

13. Abbreviations

Table 10. Abbreviations

Acronym	Description
CMOS	Complementary Metal Oxide Semiconductor
DUT	Device Under Test
ESD	ElectroStatic Discharge
HBM	Human Body Model
MM	Machine Model
TTL	Transistor-Transistor Logic
MIL	Military

14. Revision history

Table 11. Revision history

Document ID	Release date	Data sheet status	Change notice	Supersedes
74HC_HCT240_Q100 v.1	20120730	Product data sheet	-	-

15. Legal information

15.1 Data sheet status

Document status ^{[1][2]}	Product status ^[3]	Definition
Objective [short] data sheet	Development	This document contains data from the objective specification for product development.
Preliminary [short] data sheet	Qualification	This document contains data from the preliminary specification.
Product [short] data sheet	Production	This document contains the product specification.

[1] Please consult the most recently issued document before initiating or completing a design.

[2] The term 'short data sheet' is explained in section "Definitions".

[3] The product status of device(s) described in this document may have changed since this document was published and may differ in case of multiple devices. The latest product status information is available on the Internet at URL <http://www.nexperia.com>.

15.2 Definitions

Draft — The document is a draft version only. The content is still under internal review and subject to formal approval, which may result in modifications or additions. Nexperia does not give any representations or warranties as to the accuracy or completeness of information included herein and shall have no liability for the consequences of use of such information.

Short data sheet — A short data sheet is an extract from a full data sheet with the same product type number(s) and title. A short data sheet is intended for quick reference only and should not be relied upon to contain detailed and full information. For detailed and full information see the relevant full data sheet, which is available on request via the local Nexperia sales office. In case of any inconsistency or conflict with the short data sheet, the full data sheet shall prevail.

Product specification — The information and data provided in a Product data sheet shall define the specification of the product as agreed between Nexperia and its customer, unless Nexperia and customer have explicitly agreed otherwise in writing. In no event however, shall an agreement be valid in which the Nexperia product is deemed to offer functions and qualities beyond those described in the Product data sheet.

15.3 Disclaimers

Limited warranty and liability — Information in this document is believed to be accurate and reliable. However, Nexperia does not give any representations or warranties, expressed or implied, as to the accuracy or completeness of such information and shall have no liability for the consequences of use of such information. Nexperia takes no responsibility for the content in this document if provided by an information source outside of Nexperia.

In no event shall Nexperia be liable for any indirect, incidental, punitive, special or consequential damages (including - without limitation - lost profits, lost savings, business interruption, costs related to the removal or replacement of any products or rework charges) whether or not such damages are based on tort (including negligence), warranty, breach of contract or any other legal theory.

Notwithstanding any damages that customer might incur for any reason whatsoever, Nexperia's aggregate and cumulative liability towards customer for the products described herein shall be limited in accordance with the *Terms and conditions of commercial sale* of Nexperia.

Right to make changes — Nexperia reserves the right to make changes to information published in this document, including without limitation specifications and product descriptions, at any time and without notice. This document supersedes and replaces all information supplied prior to the publication hereof.

Suitability for use in automotive applications — This Nexperia product has been qualified for use in automotive applications. Unless otherwise agreed in writing, the product is not designed, authorized or warranted to be suitable for use in life support, life-critical or safety-critical systems or equipment, nor in applications where failure or malfunction of a Nexperia product can reasonably be expected to result in personal injury, death or severe property or environmental damage. Nexperia and its suppliers accept no liability for inclusion and/or use of Nexperia products in such equipment or applications and therefore such inclusion and/or use is at the customer's own risk.

Applications — Applications that are described herein for any of these products are for illustrative purposes only. Nexperia makes no representation or warranty that such applications will be suitable for the specified use without further testing or modification.

Customers are responsible for the design and operation of their applications and products using Nexperia products, and Nexperia accepts no liability for any assistance with applications or customer product design. It is customer's sole responsibility to determine whether the Nexperia product is suitable and fit for the customer's applications and products planned, as well as for the planned application and use of customer's third party customer(s). Customers should provide appropriate design and operating safeguards to minimize the risks associated with their applications and products.

Nexperia does not accept any liability related to any default, damage, costs or problem which is based on any weakness or default in the customer's applications or products, or the application or use by customer's third party customer(s). Customer is responsible for doing all necessary testing for the customer's applications and products using Nexperia products in order to avoid a default of the applications and the products or of the application or use by customer's third party customer(s). Nexperia does not accept any liability in this respect.

Limiting values — Stress above one or more limiting values (as defined in the Absolute Maximum Ratings System of IEC 60134) will cause permanent damage to the device. Limiting values are stress ratings only and (proper) operation of the device at these or any other conditions above those given in the Recommended operating conditions section (if present) or the Characteristics sections of this document is not warranted. Constant or repeated exposure to limiting values will permanently and irreversibly affect the quality and reliability of the device.

Terms and conditions of commercial sale — Nexperia products are sold subject to the general terms and conditions of commercial sale, as published at <http://www.nexperia.com/profile/terms>, unless otherwise agreed in a valid written individual agreement. In case an individual agreement is concluded only the terms and conditions of the respective agreement shall apply. Nexperia hereby expressly objects to applying the customer's general terms and conditions with regard to the purchase of Nexperia products by customer.

No offer to sell or license — Nothing in this document may be interpreted or construed as an offer to sell products that is open for acceptance or the grant, conveyance or implication of any license under any copyrights, patents or other industrial or intellectual property rights.

Export control — This document as well as the item(s) described herein may be subject to export control regulations. Export might require a prior authorization from competent authorities.

Translations — A non-English (translated) version of a document is for reference only. The English version shall prevail in case of any discrepancy between the translated and English versions.

15.4 Trademarks

Notice: All referenced brands, product names, service names and trademarks are the property of their respective owners.

16. Contact information

For more information, please visit: <http://www.nexperia.com>

For sales office addresses, please send an email to: salesaddresses@nexperia.com

17. Contents

1	General description	1
2	Features and benefits	1
3	Ordering information	1
4	Functional diagram	2
5	Pinning information	3
5.1	Pinning	3
5.2	Pin description	3
6	Functional description	4
7	Limiting values	4
8	Recommended operating conditions	4
9	Static characteristics	5
10	Dynamic characteristics	6
11	Waveforms	8
12	Package outline	10
13	Abbreviations	13
14	Revision history	13
15	Legal information	14
15.1	Data sheet status	14
15.2	Definitions	14
15.3	Disclaimers	14
15.4	Trademarks	15
16	Contact information	15
17	Contents	16