

S32K116 EVB

QUICK START GUIDE

APPLIES FOR: S32K116 EVB (SCH_30003 REV B)



EXTERNAL USE



SECURE CONNECTIONS
FOR A SMARTER WORLD

Contents:

- Get to Know S32K116 EVB
- Out of the Box Setup
- Introduction to OpenSDA
- Creating a new S32DS project for S32K116:
 - Download
 - Create a project
 - Create a project from SDK example
- S32DS Debug basics
- Create a P&E debug configuration



Get to know S32K116-EVB

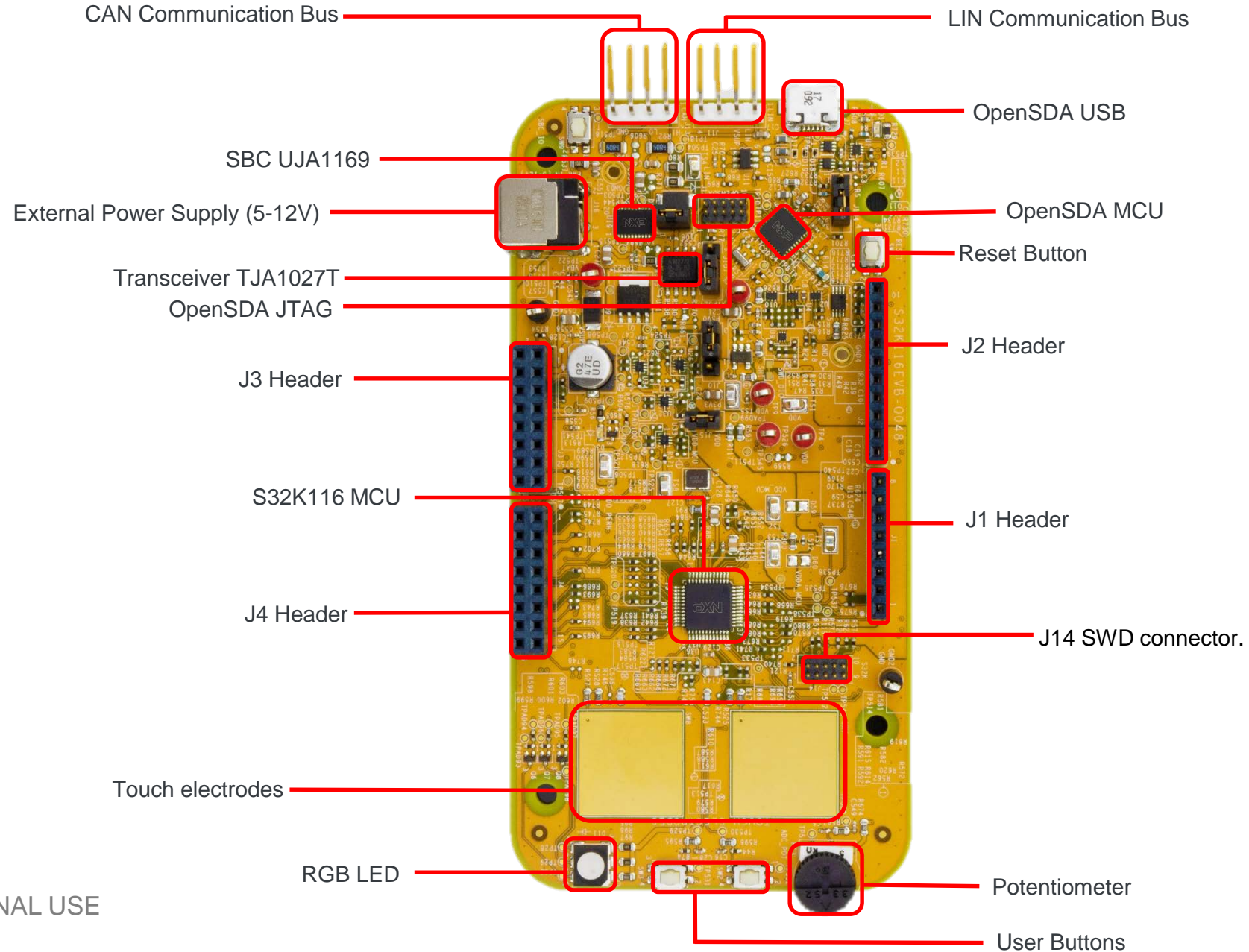

S32K116 EVB Features:

- Supports **48LQFP** and **32QFN** packages
- Small form factor size 4.5" x 2.3"
- Arduino™ UNO footprint-compatible with expansion "shield" support
- Integrated open-standard serial and debug adapter (OpenSDA) with support for several industry-standard debug interfaces
- Easy access to the MCU I/O header pins for prototyping
- On-chip connectivity for CAN, LIN, UART/SCI.
- SBC UJA1169 and LIN phy TJA1027
- Potentiometer for precise voltage and analog measurement
- RGB LED
- Two push-button switches (SW2 and SW3) and two touch electrodes
- Flexible power supply options
 - microUSB
 - external 12V power supply

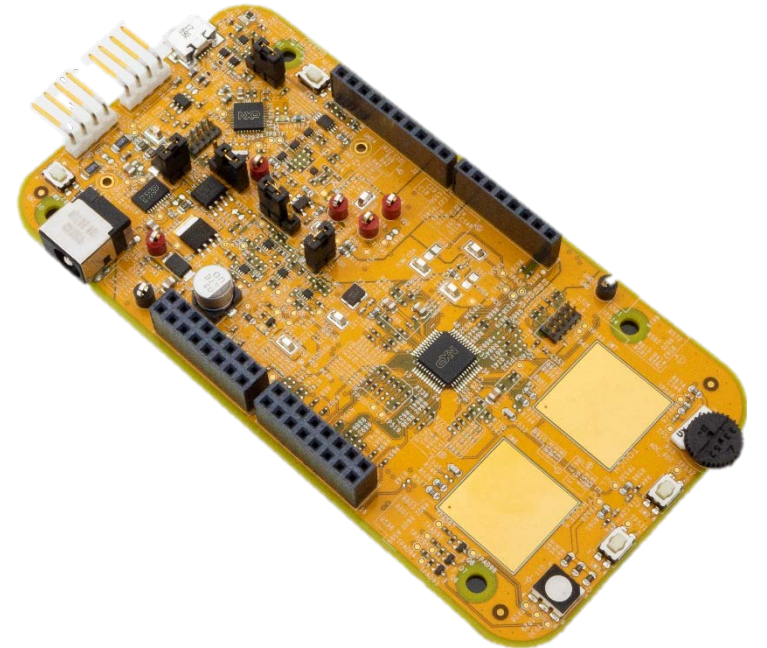

Header/Pinout Mapping for S32K116

PIN	PORT	FUNCTION	J3	PIN	PORT	FUNCTION
J3-02	PTB0	GPIO	■	J3-01	-	VBAT
J3-04	PTB1	GPIO	■	J3-03	-	VDD_PERH
J3-06	PTB6	GPIO	■	J3-05	PTA5	RESET
J3-08	PTB7	GPIO	■	J3-07	-	3.3V
J3-10	PTE4	GPIO	■	J3-09	-	5V
J3-12	PTE5	GPIO	■	J3-11	-	GND
J3-14	PTA11	GPIO	■	J3-13	-	GND
J3-16	PTD3	GPIO	■	J3-15	-	VBAT

PIN	PORT	FUNCTION	J4	PIN	PORT	FUNCTION
J4-02	PTC6	GPIO	■	J4-01	PTA7	ADC0_SE3
J4-04	PTC7	GPIO	■	J4-03	PTC8	GPIO
J4-06	PTC8	GPIO	■	J4-05	PTC1	ADC0_SE9
J4-08	PTC9	GPIO	■	J4-07	PTC14	ADC0_SE12
J4-10	PTD5	GPIO	■	J4-09	PTC15	ADC0_SE13
J4-12	PTD15	GPIO	■	J4-11	PTC16	ADC0_SE14
J4-14	PTD16	GPIO	■	J4-13	PTC9	GPIO
J4-16	PTE8	GPIO	■	J4-15	PTB13	GPIO

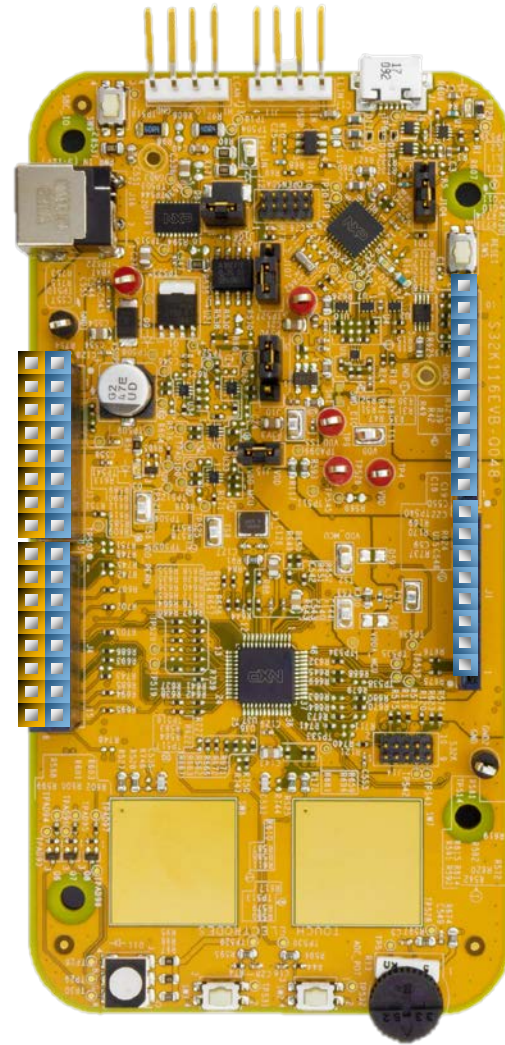

J2	PIN	PORT	FUNCTION
■	J2-01	PTC2	FTM0_CH2
■	J2-02	PTC3	FTM0_CH3
■	J2-03	PTB5	LPSPIO_PCS
■	J2-04	PTB4	LPSPIO_SOUT
■	J2-05	PTB3	LPSPIO_SIN
■	J2-06	PTB2	LPSPIO_SCK
■	J2-07	-	GND
■	J2-08	-	AREF
■	J2-09	PTA1	LPI2CO_SDA
■	J2-10	PTA0	LPI2CO_SCL

J1	PIN	PORT	FUNCTION
■	J1-01	PTA2	LPUART0_RX
■	J1-02	PTA3	LPUART0_TX
■	J1-03	PTA13	FTM1_CH7
■	J1-04	PTA12	FTM1_CH6
■	J1-05	PTD0	FTM0_CH2
■	J1-06	PTD1	FTM0_CH3
■	J1-07	PTD2	FXIO_D4
■	J1-08	PTE9	FTM0_CH7

Jumper Settings

Jumper	Configuration	Description
J104	1-2	Reset signal to OpenSDA, use to enter into OpenSDA Bootloader mode
	2-3 (Default)	Reset signal direct to the MCU, use to reset S32K116.
J107	1-2 (Default)	S32K116 powered by 12V power source.
	2-3	S32K116 powered by USB micro connector.
J10	2-3 (Default)	MCU voltage 5v
	1-2	MCU voltage 3.3v
J108	1-2 (Default)	Select LIN master option
J15	1-2 (Default)	Used for current measurement

HMI mapping

Component	S32K116
Red LED	PTD16 (FTM0 CH1)
Blue LED	PTE8(FTM0 CH6)
Green LED	PTD15(FTM0 CH0)
Potentiometer	PTA7 (ADC0_SE3)
SW2	PTD3
SW3	PTD5
OpenSDA UART TX	PTB1(LPUART0_TX)
OpenSDA UART RX	PTB0(LPUART0_RX)
CAN TX	PTE5(CAN0_TX)
CAN RX	PTE4 (CAN0_RX)
LIN TX	PTC7(LPUART1_TX)
LIN RX	PTC6 (LPUART1_RX)
SBC_SCK	PTB2 (LPSPI0_SCK)
SBC_MISO	PTB3(LPSPI0_SIN)
SBC_MOSI	PTB4(LPSPI0_SOUT)
SBC_CS	PTB5(LPSPI0_PCS1)

S32K116 EVB OUT OF THE BOX



Step 1: Power up the Board – EVB Power Supplies

- The S32K116-EVB evaluation board powers from a USB or external 12V power supply. By default 12V power is enabled with J107 (check slide 5)
- Connect the USB cable to a PC using supplied USB cable .
- Connect other end of USB cable (microUSB) to mini-B port on S32K116-EVB at J7
- Allow the PC to automatically configure the USB drivers if needed
- Debug is done using OpenSDA through J7

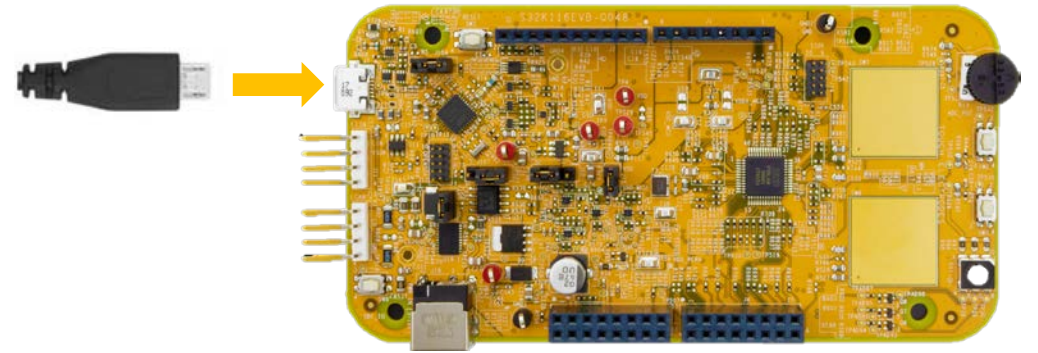

Step 2: Power up the Board – Is it powered on correctly?

- When powered through USB, LEDs D2 and D3 should light green
- Once the board is recognized, it should appear as a mass storage device in your PC with the name S32K116EVB.



Step 3: Power up the Board – Is it powered on correctly?

- Board is preloaded with a software, in which the red, blue and green leds will toggle at different rates.

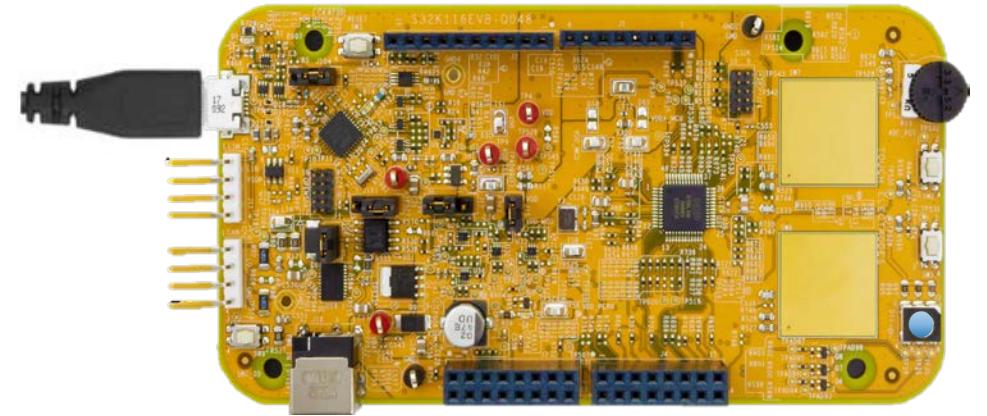

**S32K116 JUMPSTART
EXPERIENCE
BASED ON THE
FREEMASTER TOOL**



Install the FreeMASTER tool

- Download and install the FreeMASTER PC application www.nxp.com/FreeMASTER.
- Open the FreeMASTER application on your PC. You should see Welcome page:

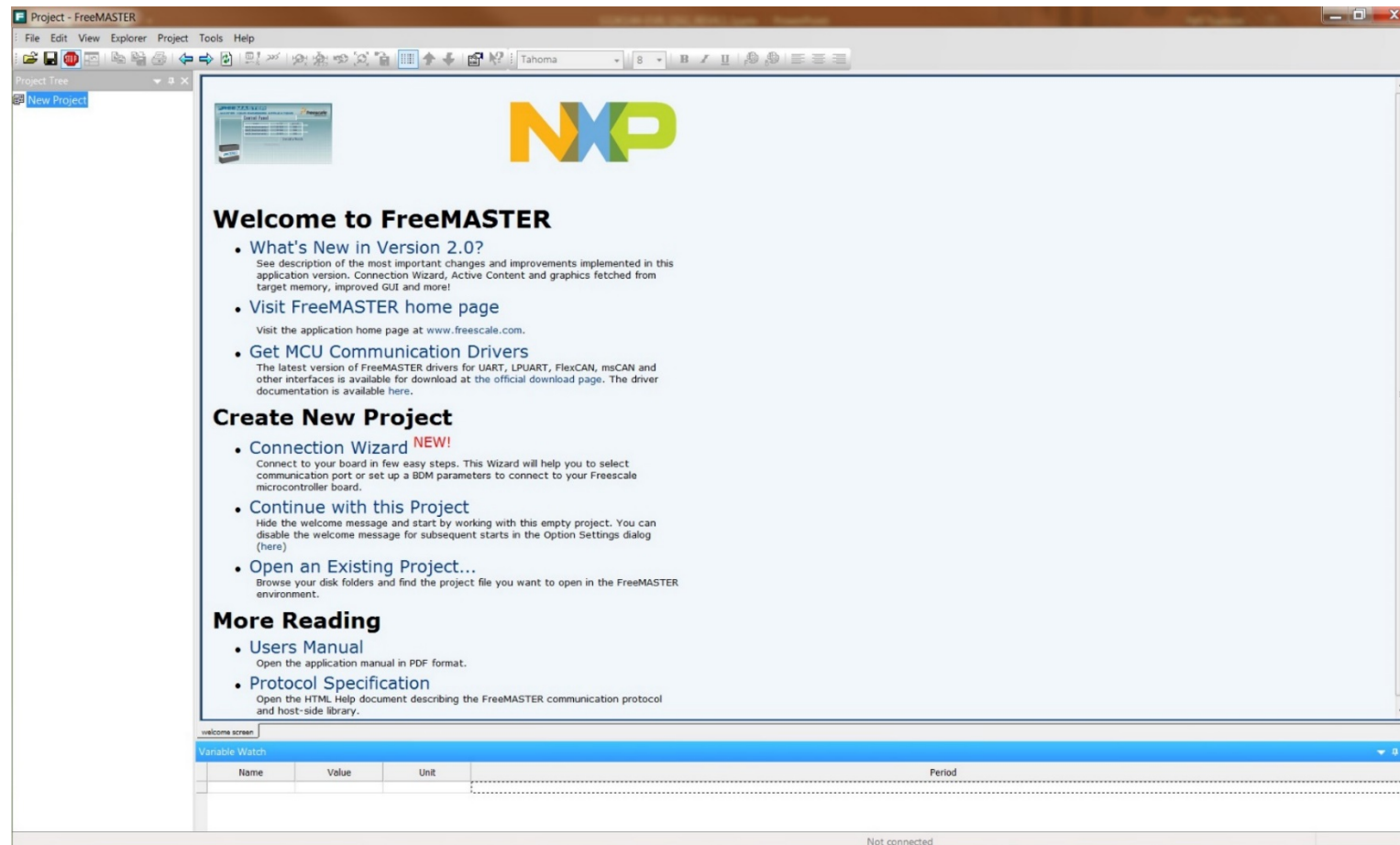

Power up the EVB board

- Powers the S32K116EVB evaluation board from a USB. By default, the USB power is enabled by J07 jumper.
- Connect the USB cable to a PC and connect micro USB connector of the USB cable to micro-B port J7 on the S32K116EVB.
- Allow the PC to automatically configure the USB drivers if needed.
- When EVB is powered from USB, LEDs D2 and D3 should light green.
- The EVB board is preloaded with a software toggling the RGB LED colors periodically between RED-GREEN-BLUE.

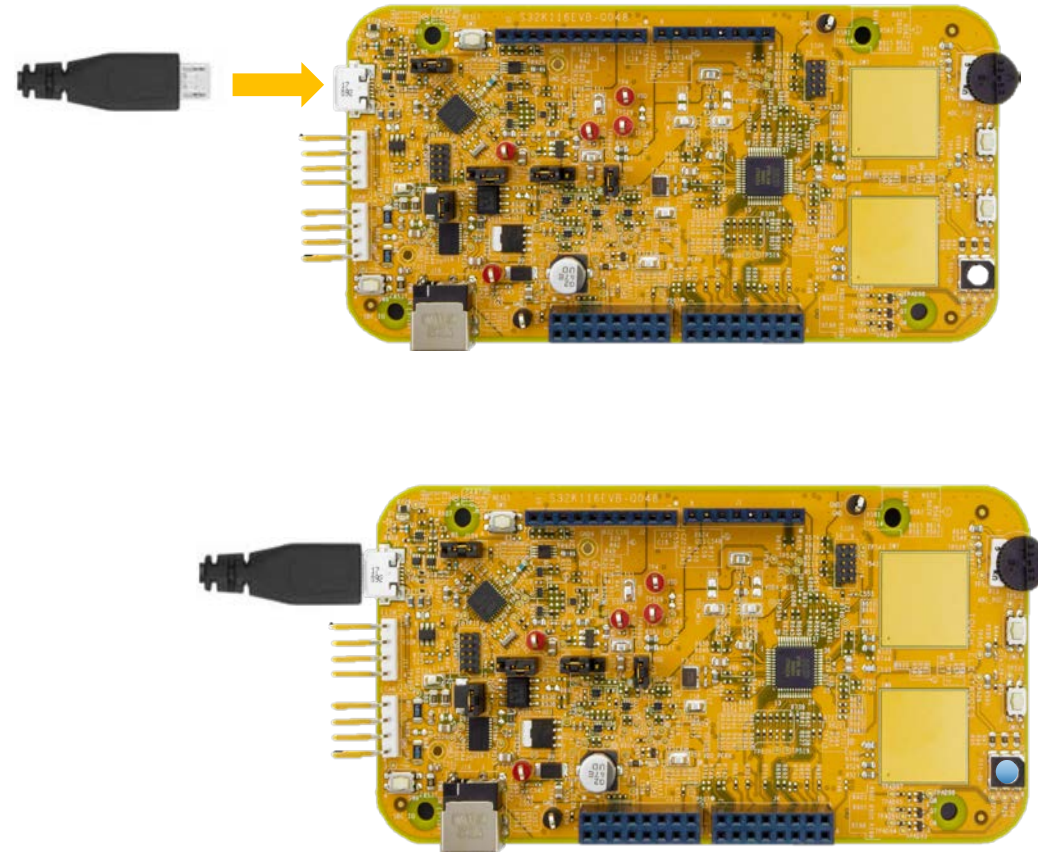

Setup serial connection in the FreeMASTER tool

Setup communication port to “OpenSDA” and speed to 115200 b/s:

- Setup communication manually:
Go to: “Project > Options > Comm”

OR

- Setup communication automatically:
Go to “Tools > Connection Wizard”

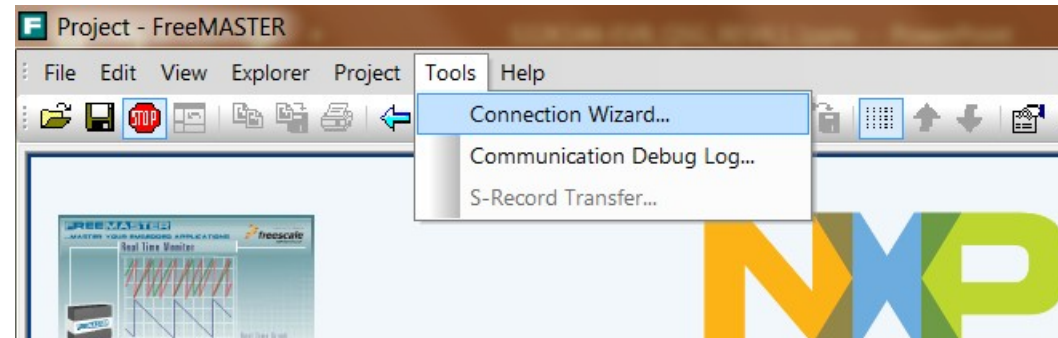
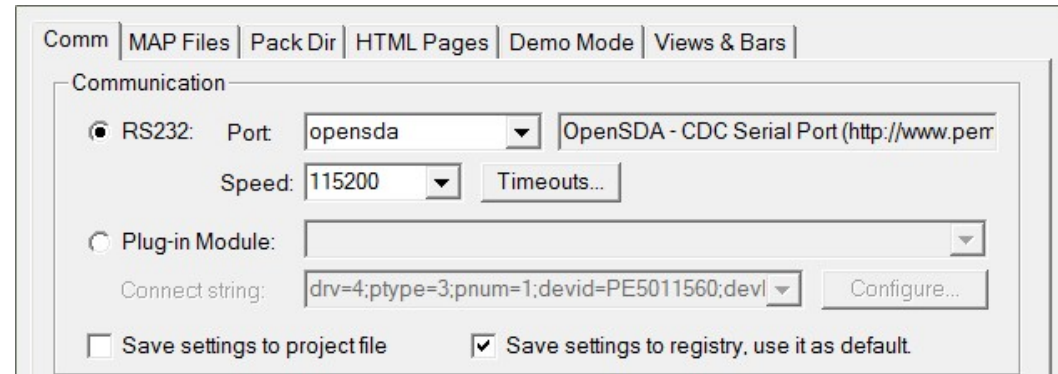

The FreeMASTER JumpStart project is loaded

Pins of the J2 and J1 connectors are configured as outputs.

na	na	na	V-	1	1	1	1	1	1	1	1	1	1	1	1	1	1
CONNECTOR 'J2'				CONNECTOR 'J1'													

Pins of the J3 and J4 connectors are configured as inputs.

V+	V+	na	V+	V+	V-	V-	V+	na	0	na	0	0	na	0	0	
1	1	na	na	0	0	0	0	na	na	0	0	0	0	1	1	1
CONNECTOR 'J3'				CONNECTOR 'J4'												

S32K1xx Web Links:

- >> S32K Overview
- >> S32K116 Evaluation Board:
 - > Getting Started
 - > S32K116EVB Quick Start Guide
 - > S32K116EVB-Q048 Schematic
 - > S32K1xx Fact Sheet
 - > S32K1xx Data Sheet
 - > S32K1xx Reference Manual
 - > S32K1xx Product Brief
- >> SW Tools:
 - > FreeMASTER Run-Time Debugging Tool
 - > S32 Design Studio IDE
- >> S32K116 JumpStart Sources:
 - > S32K116 EVB JumpStart PC Host Project
 - > S32K116 EVB JumpStart Firmware

control page

RS232 UART Communication; COM34; speed=115200



The FreeMASTER JumpStart project description

Pins of the J2 and J1 connectors are configured as outputs. By single click on each pin you can change their logical level to log0 or log1. User can connect e.g. LED diodes to these output pins.

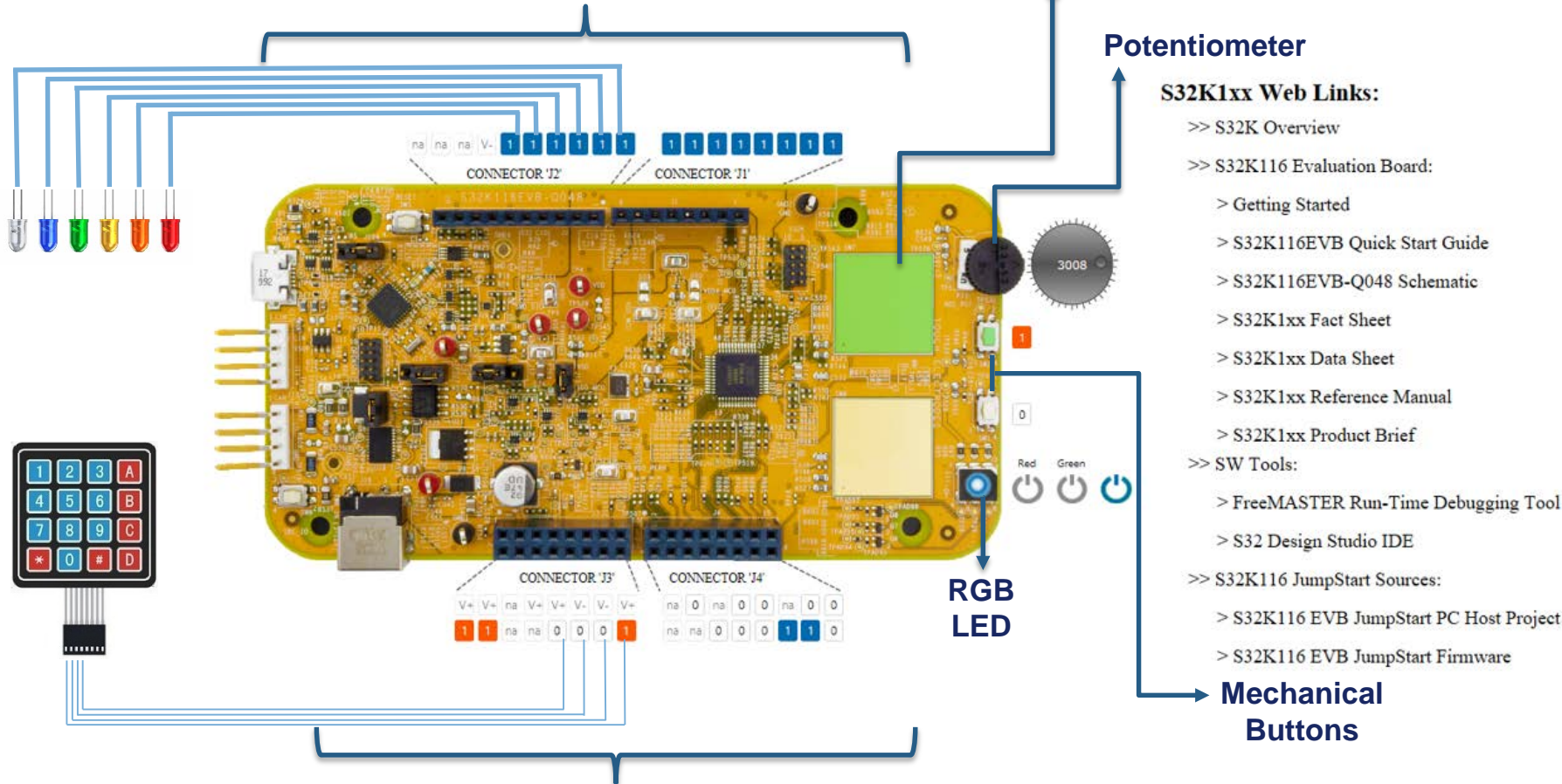

Pins of the J3 and J4 connectors are configured as inputs. Logical level (log0/log1) is visualised for all connector pins. User can connect e.g. push-button keyboard to these input pins.

S32K1xx Web Links:

- >> S32K Overview
- >> S32K116 Evaluation Board:
 - > Getting Started
 - > S32K116EVB Quick Start Guide
 - > S32K116EVB-Q048 Schematic
 - > S32K1xx Fact Sheet
 - > S32K1xx Data Sheet
 - > S32K1xx Reference Manual
 - > S32K1xx Product Brief
- >> SW Tools:
 - > FreeMASTER Run-Time Debugging Tool
 - > S32 Design Studio IDE
- >> S32K116 JumpStart Sources:
 - > S32K116 EVB JumpStart PC Host Project
 - > S32K116 EVB JumpStart Firmware

Links to S32K1xx docs:

- Fact Sheet
- Data Sheet
- Reference Manual
- Product Brief
- S32K116EVB schematic
- S32K116EVB Quick Start Guide
- Tools:
 - FreeMASTER
 - S32 Design Studio IDE
- S32K116EVB JumpStart source files

The FreeMASTER JumpStart oscilloscope feature examples

- Display main project panel “View > Project Tree”.

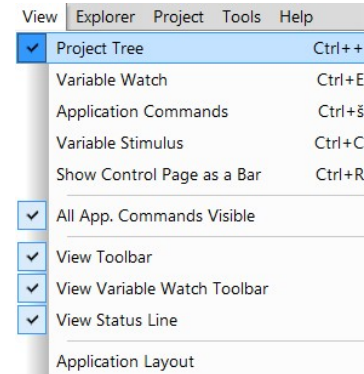

- Display real-time oscilloscope graph examples such as „Potentiometer“ or „Touch Sense Electrodes“.

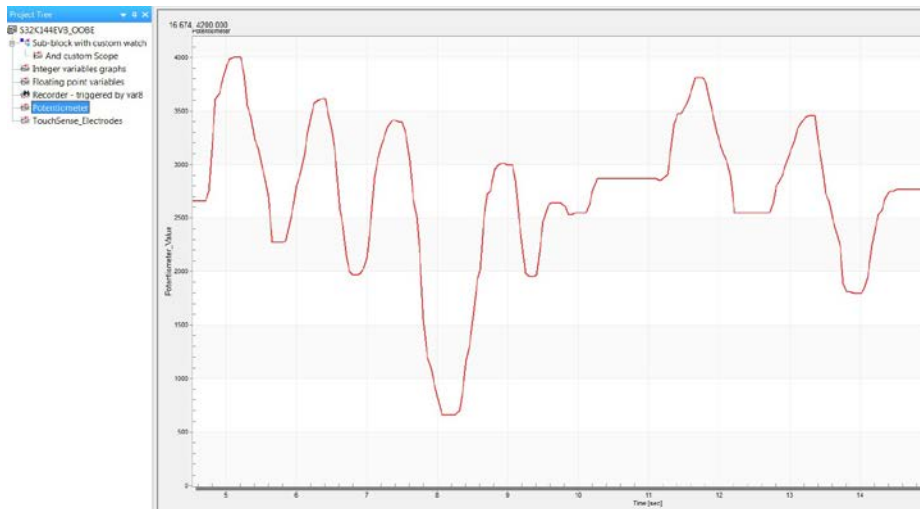

Analog values from potentiometer.

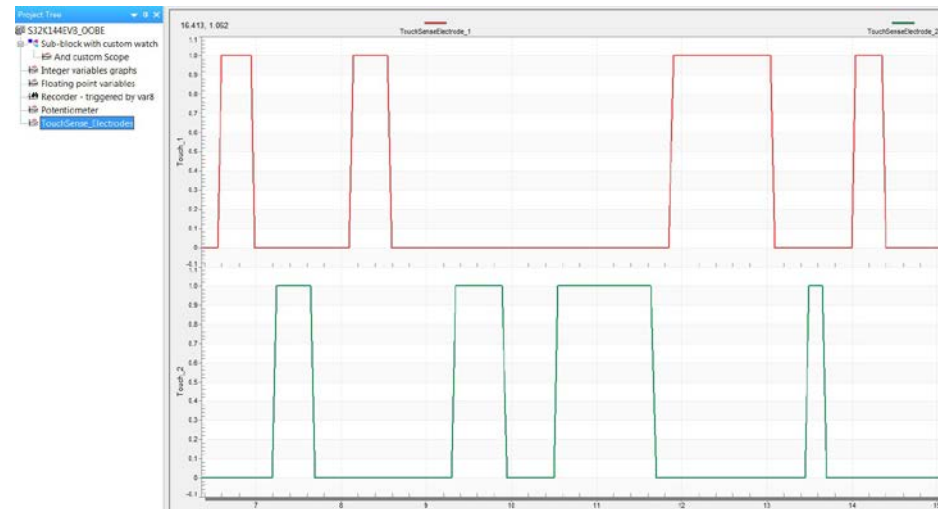

Responses from touch sense electrodes.

INTRODUCTION TO OPENSDA



Introduction to OpenSDA: 1 of 2

OpenSDA is an open-standard serial and debug adapter. It bridges serial and debug communications between a USB host and an embedded target processor. OpenSDA software includes a flash-resident USB mass-storage device (MSD) bootloader and a collection of OpenSDA Applications. S32K116 EVB comes with the MSD Flash Programmer OpenSDA Application preinstalled. Follow these instructions to run the OpenSDA Bootloader and update or change the installed OpenSDA Application.

Enter OpenSDA Bootloader Mode

1. Unplug the USB cable if attached
2. Set J104 on position 1-2.
3. Press and hold the Reset button (SW5)
4. Plug in a USB cable (not included) between a USB host and the OpenSDA USB connector (labeled "SDA")
5. Release the Reset button

A removable drive should now be visible in the host file system with a volume label of **BOOTLOADER**. You are now in OpenSDA Bootloader mode.

IMPORTANT NOTE: Follow the "Load an OpenSDA Application" instructions to update the MSD Flash Programmer on your S32K116 EVB to the latest version.

Load an OpenSDA Application

1. While in OpenSDA Bootloader mode, double-click **SDA_INFO.HTML** in the **BOOTLOADER** drive. A web browser will open the OpenSDA homepage containing the name and version of the installed Application. This information can also be read as text directly from **SDA_INFO.HTML**
2. Locate the **OpenSDA Applications**
3. Copy & paste or drag & drop the MSD Flash Programmer Application to the **BOOTLOADER** drive
4. Unplug the USB cable and plug it in again. The new OpenSDA Application should now be running and a **S32K116 EVB** drive should be visible in the host file system

You are now running the latest version of the MSD Flash Programmer. Use this same procedure to load other OpenSDA Applications.



Introduction to OpenSDA: 2 of 2

The MSD Flash Programmer is a composite USB application that provides a virtual serial port and an easy and convenient way to program applications into the S32K116 MCU. It emulates a FAT file system, appearing as a removable drive in the host file system with a volume label of S32K116EVB. Raw binary and Motorola S-record files that are copied to the drive are programmed directly into the flash of the S32K116 and executed automatically. The virtual serial port enumerates as a standard serial port device that can be opened with standard serial terminal applications.

Using the MSD Flash Programmer

1. Locate the .srec file of your project , file is under the Debug folder of the S32DS project.
2. Copy & paste or drag & drop one of the .srec files to the S32K116EVB drive

The new application should now be running on the S32K116 EVB. Starting with v1.03 of the MSD Flash Programmer, you can program repeatedly without the need to unplug and reattach the USB cable before reprogramming.

Drag one of the .srec code for the S32K116 EVB board over USB to reprogram the preloaded code example to another example.

NOTE: Flash programming with the MSD Flash Programmer is currently only supported on Windows operating systems. However, the virtual serial port has been successfully tested on Windows, Linux and Mac operating systems.

Using the Virtual Serial Port

1. Determine the symbolic name assigned to the S32K116EVB virtual serial port. In Windows open Device Manager and look for the COM port named “PEMicro/Freescale – CDC Serial Port”.
2. Open the serial terminal emulation program of your choice. Examples for Windows include [Tera Term](#), [PuTTY](#), and [HyperTerminal](#)
3. Press and release the Reset button (SW5) at anytime to restart the example application. Resetting the embedded application will not affect the connection of the virtual serial port to the terminal program.
4. It is possible to debug and communicate with the serial port at the same time, no need to stop the debug.

NOTE: Refer to the OpenSDA User’s Guide for a description of a known Windows issue when disconnecting a virtual serial port while the COM port is in use.



INSTALLING S32DS



Download S32DS

Download S32DS from:

[S32DS for ARM](#)

CREATE A NEW PROJECT IN S32 DESIGN STUDIO



Create New Project: First Time – Select a Workspace

- Start program: Click on “S32 Design Studio for ARM v2.0” icon
- Select workspace:
 - Choose default (see below example) or specify new one
 - Suggestion: Uncheck the box “Use this as the default and do not ask again”
 - Click OK

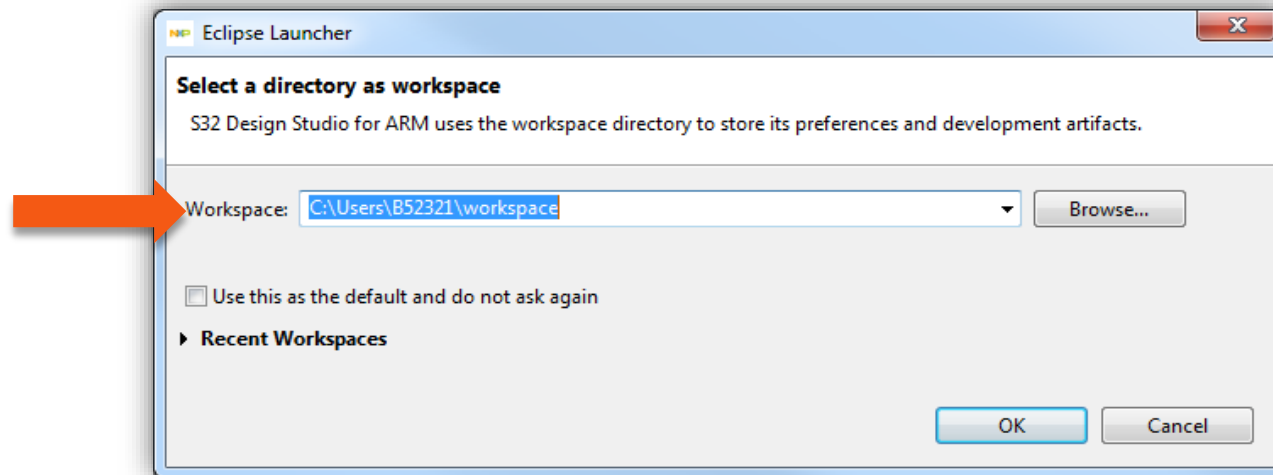

Create New Project: Top Menu Selection

- File – New –Project

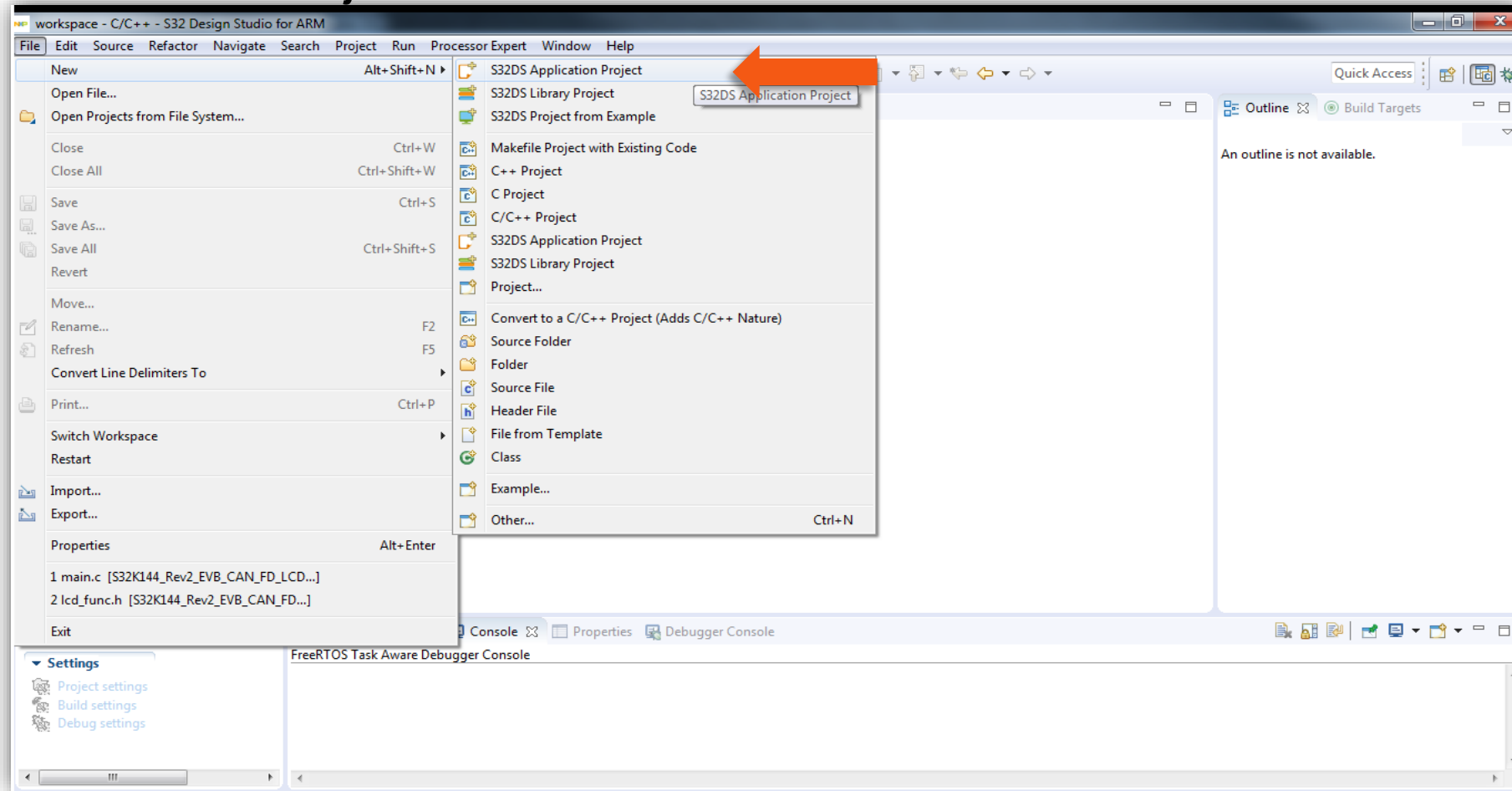

Create New Project: S32DS Project

- Project Name:
 - Example: FirstProject
- Project Type:
 - Select from inside executable or library folder
- Next



New S32DS Application Project

Create a S32 Design Studio Project

S32DS Application Project

Project name: FirstProject

Use default location

Location: C:\Users\nxa12689\workspaceS32DS.ARM\FirstProject Browse...

Processors:

type filter text

- > Family KEA
- > Family S32K1xx
 - S32K144
 - S32K142
 - S32K148
 - S32K118
 - S32K146
 - S32K116
- > Family MAC57D5xx
- > Family S32V

ToolChain Selection:

Core Kind	Name	Toolchain
M0plus	Cortex-M0+	Standard S32DS toolchain for ARM

Description:

GCC toolchain is selected

Next > Finish Cancel

Create New Project: S32DS Project

- Select Debugger Support and Library Support
- Click Finish

New S32DS Application Project

New S32DS Project for S32K116
Select required cores and parameters for them.

Project Name	FirstProject
Core	<input checked="" type="checkbox"/> Cortex-M0+
Library	EWL
I/O Support	No I/O
FPU Support	Toolchain Default
Language	C
SDKs	...
Debugger	PE Micro GDB server

< Back Finish Cancel

OpenSDA Configuration

- To Debug your project with OpenSDA, it is necessary to select the OpenSDA in the Debug Configuration.
- Select your project, and click on debug configuration

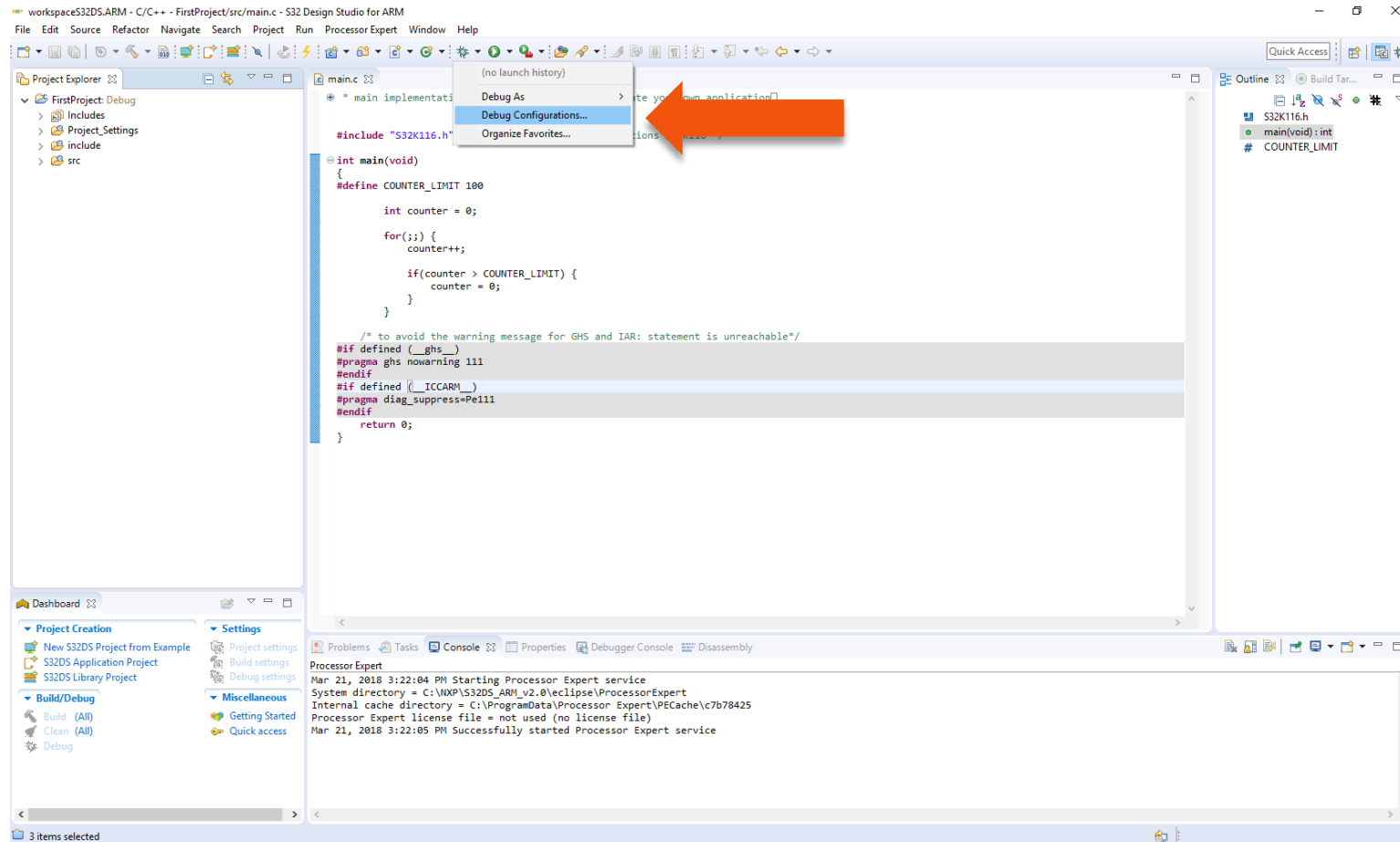

OpenSDA Configuration

- Select the Debug configuration under GDB PEMicro Interface Debugging
- Click on Debugger tab

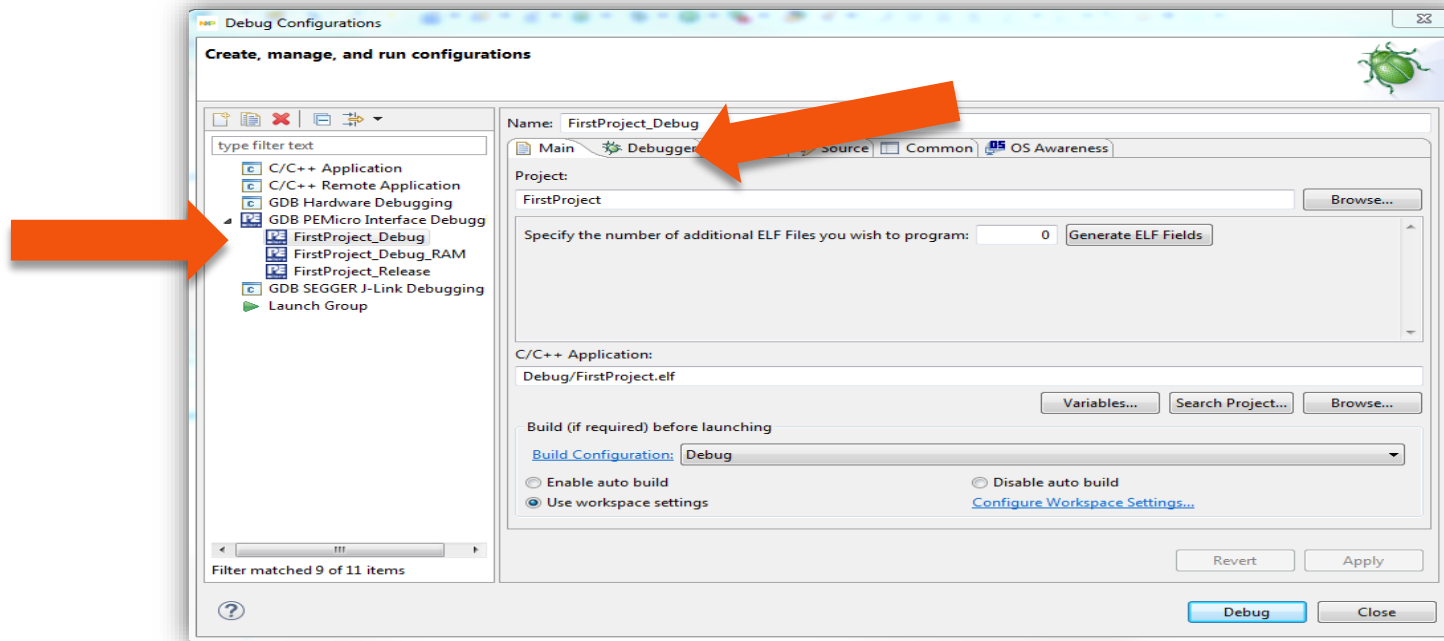

OpenSDA Configuration

- Select OpenSDA as the interface, if your board is plugged should appear in the Port field.
- Click Apply and debug to finish.

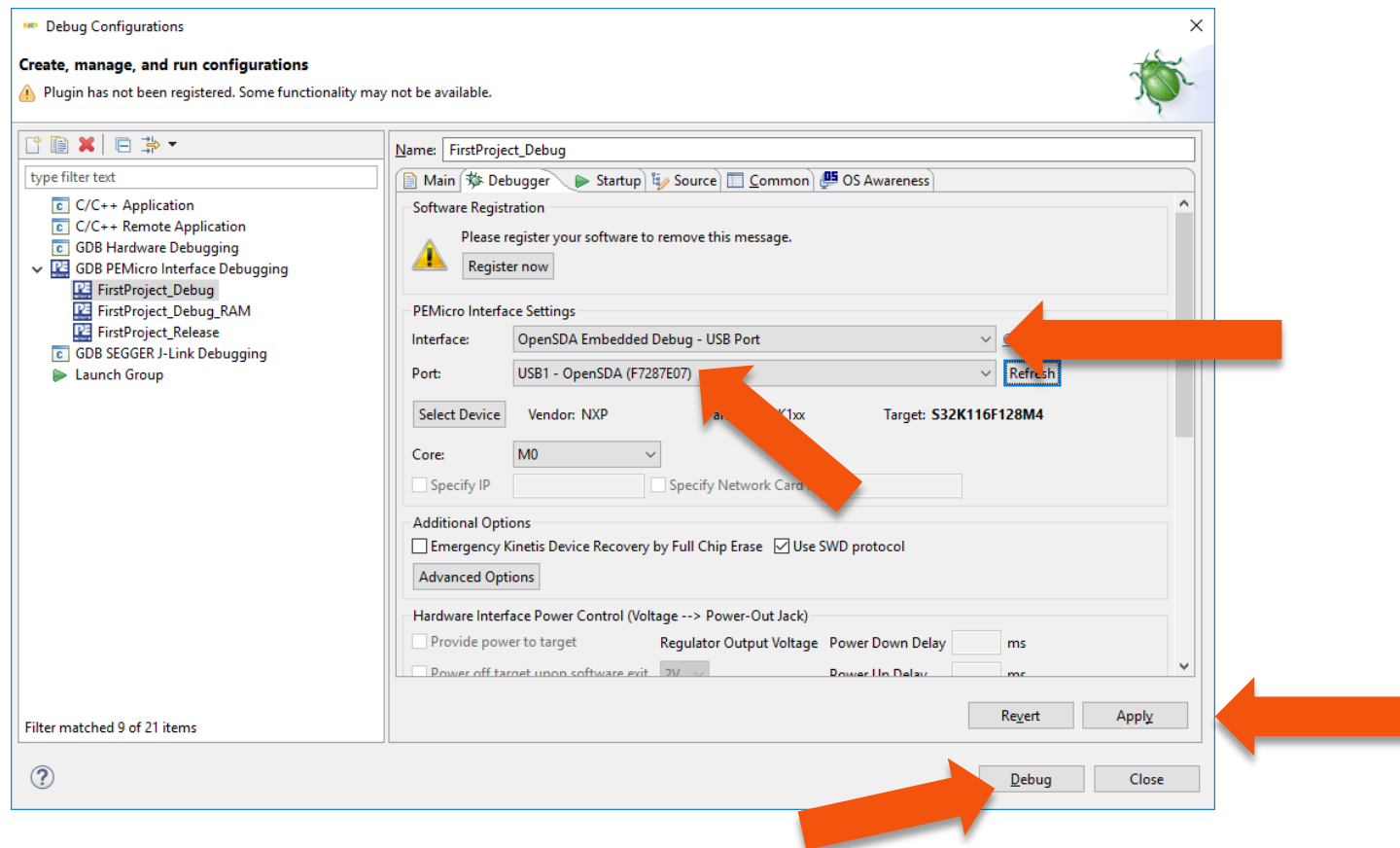

DEBUG BASICS



Debug Basics: Starting the Debugger

- Debug configuration is only required once. Subsequent starting of debugger does not require those steps.
- Three options to start debugger:
 - If the “Debug Configuration” has not been closed, click on “Debug” button on bottom right
 - Select Run – Debug (or hit F11)

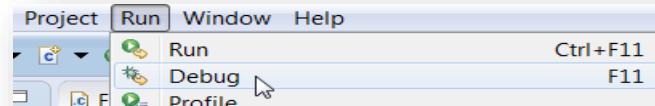

Note: This method currently selects the desktop target (*project.elf*) and gives an error. Do not use until this is changed.

- Recommended Method: Click on pull down arrow for bug icon and select ..._debug.elf target

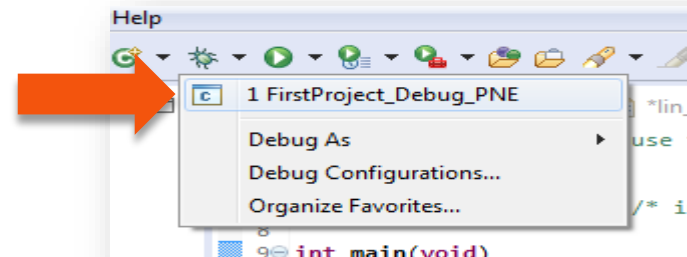

Debug Basics: Step, Run, Suspend, Resume

- Step Into (F5)

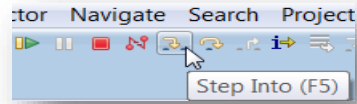

- Step Over (F6)

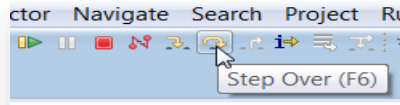

- Step Return (F7)

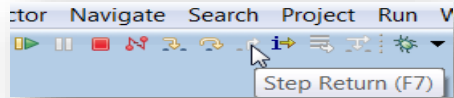

- Run

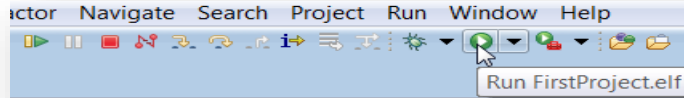

- Suspend

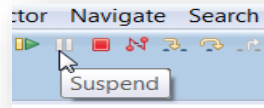

- Resume (F8)

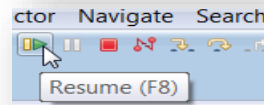

Debug Basics: View & Alter Variables

- View variables in “Variables” tab.
- Click on a value to allow typing in a different value.

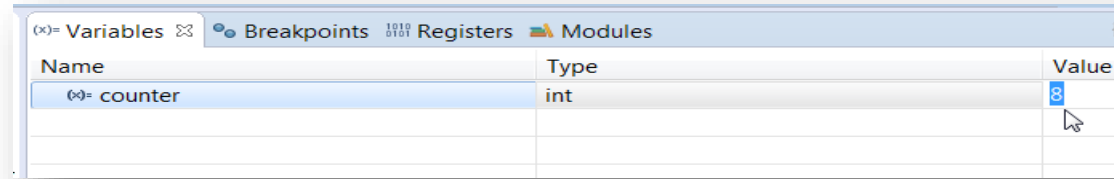

Debug Basics: View & Alter Registers

- View CPU registers in the “Registers” tab
- Click on a value to allow typing in a different value
- View peripheral registers in the EmbSys Registers tab

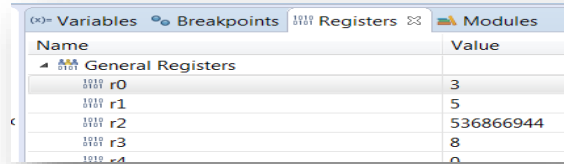

Name	Value
General Registers	
r0	3
r1	5
r2	536866944
r3	8
r4	0

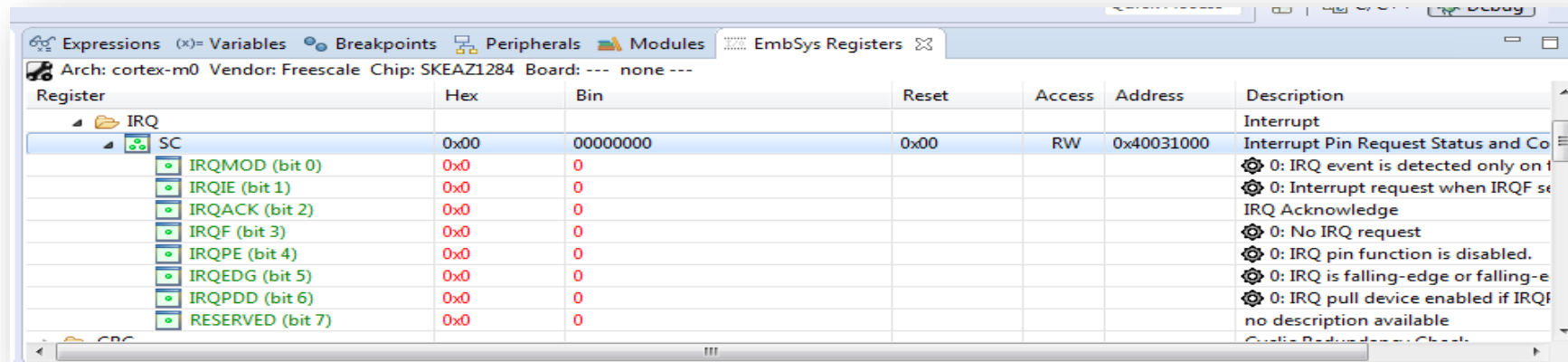

Register	Hex	Bin	Reset	Access	Address	Description
IRQ						Interrupt
SC	0x00	00000000	0x00	RW	0x40031000	Interrupt Pin Request Status and Control
IRQMOD (bit 0)	0x0	0				0: IRQ event is detected only on falling edge
IRQIE (bit 1)	0x0	0				0: Interrupt request when IRQF set
IRQACK (bit 2)	0x0	0				IRQ Acknowledge
IRQF (bit 3)	0x0	0				0: No IRQ request
IRQPE (bit 4)	0x0	0				0: IRQ pin function is disabled.
IRQEDG (bit 5)	0x0	0				0: IRQ is falling-edge or falling-edge
IRQPDD (bit 6)	0x0	0				0: IRQ pull device enabled if IRQF set
RESERVED (bit 7)	0x0	0				no description available

Debug Basics: View & Alter Memory

- Add Memory Monitor

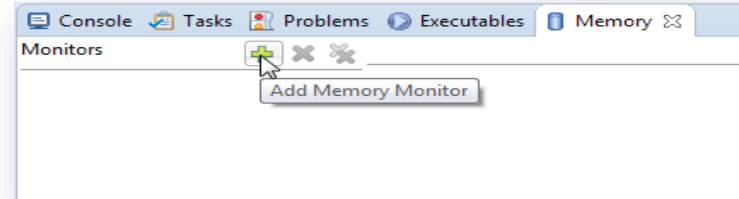

- Select Base Address
to Start at : 0x20000000

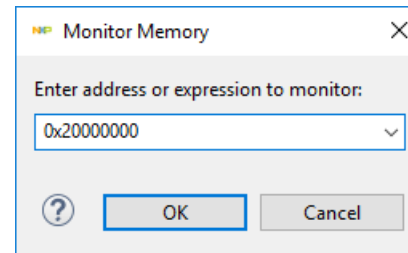

- View Memory

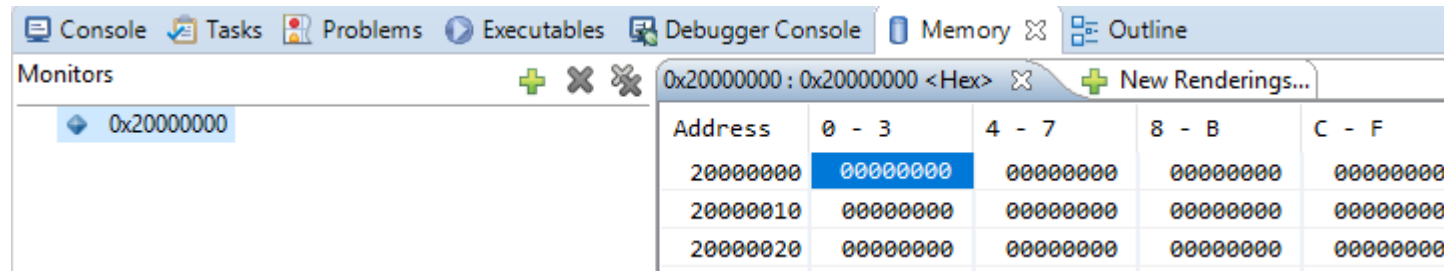

Debug Basics: Breakpoints

Add Breakpoint: Point and Click

- light blue dot represents debugger breakpoint

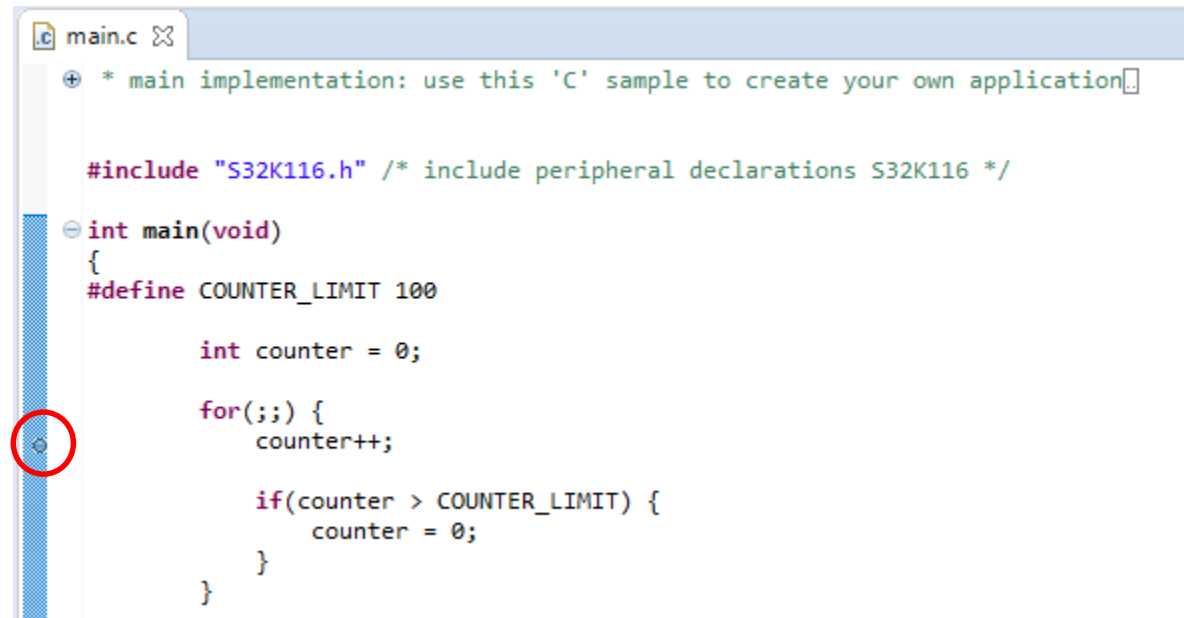

```
main.c ✕
+ * main implementation: use this 'C' sample to create your own application.

#include "S32K116.h" /* include peripheral declarations S32K116 */

- int main(void)
{
#define COUNTER_LIMIT 100

    int counter = 0;

    for(;;) {
        counter++;

        if(counter > COUNTER_LIMIT) {
            counter = 0;
        }
    }
}
```

The screenshot shows a code editor window titled 'main.c'. The code is a C program with a 'for(;;)' loop. A light blue dot, representing a debugger breakpoint, is placed on the line 'for(;;) {'. A red circle is drawn around this dot to highlight it.

Debug Basics: Reset & Terminate Debug Session

- Reset program counter
- Terminate Ctrl+F2()

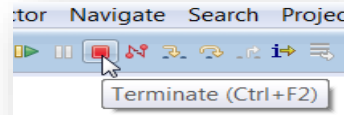

CREATE A P&E DEBUG CONFIGURATION (OPTIONAL)

New P&E debug configuration

- Click in debug configurations

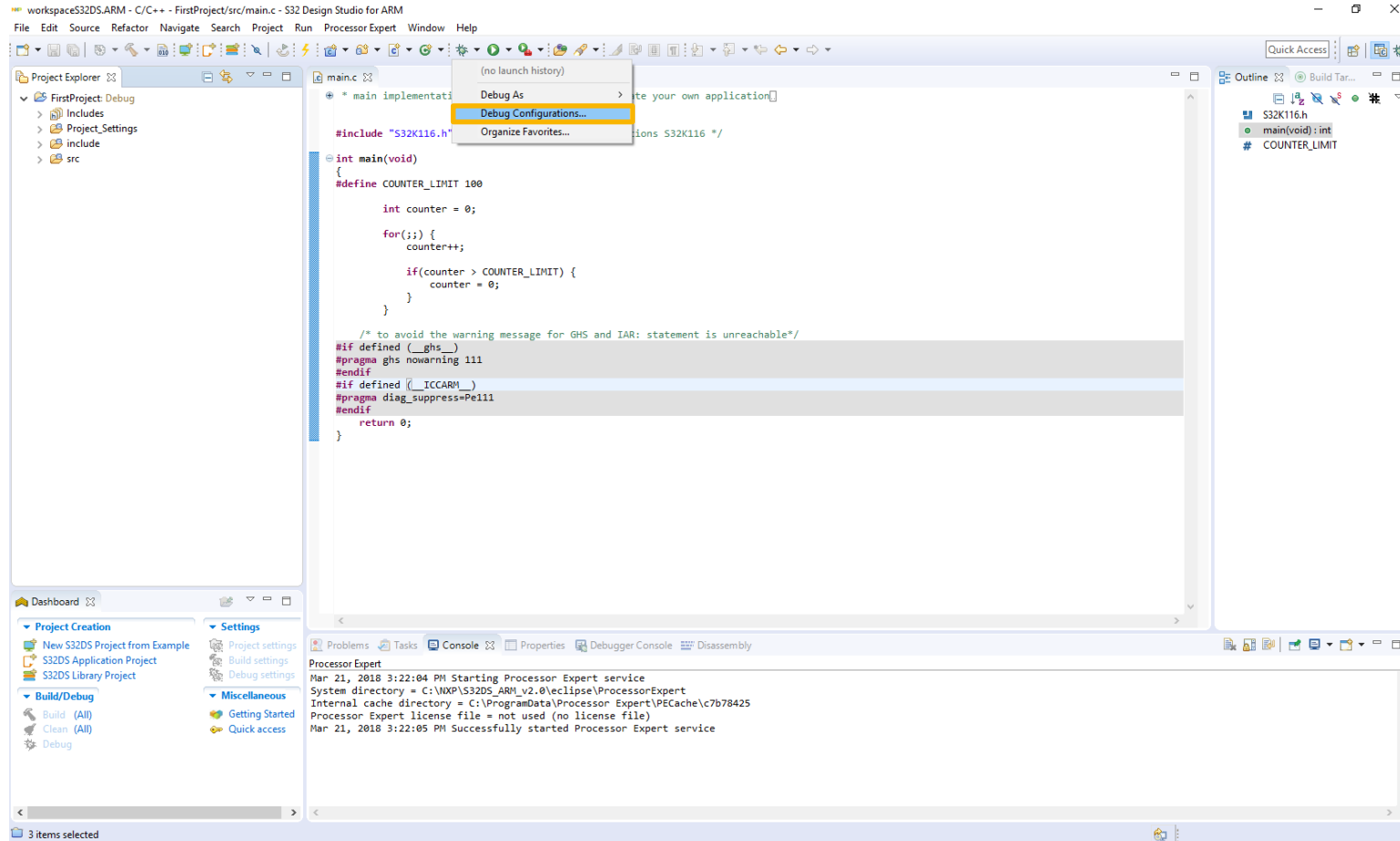

New P&E debug configuration

- Create a new P&E launch configuration

Click to create a new P&E launch

Click on the debugger tab.

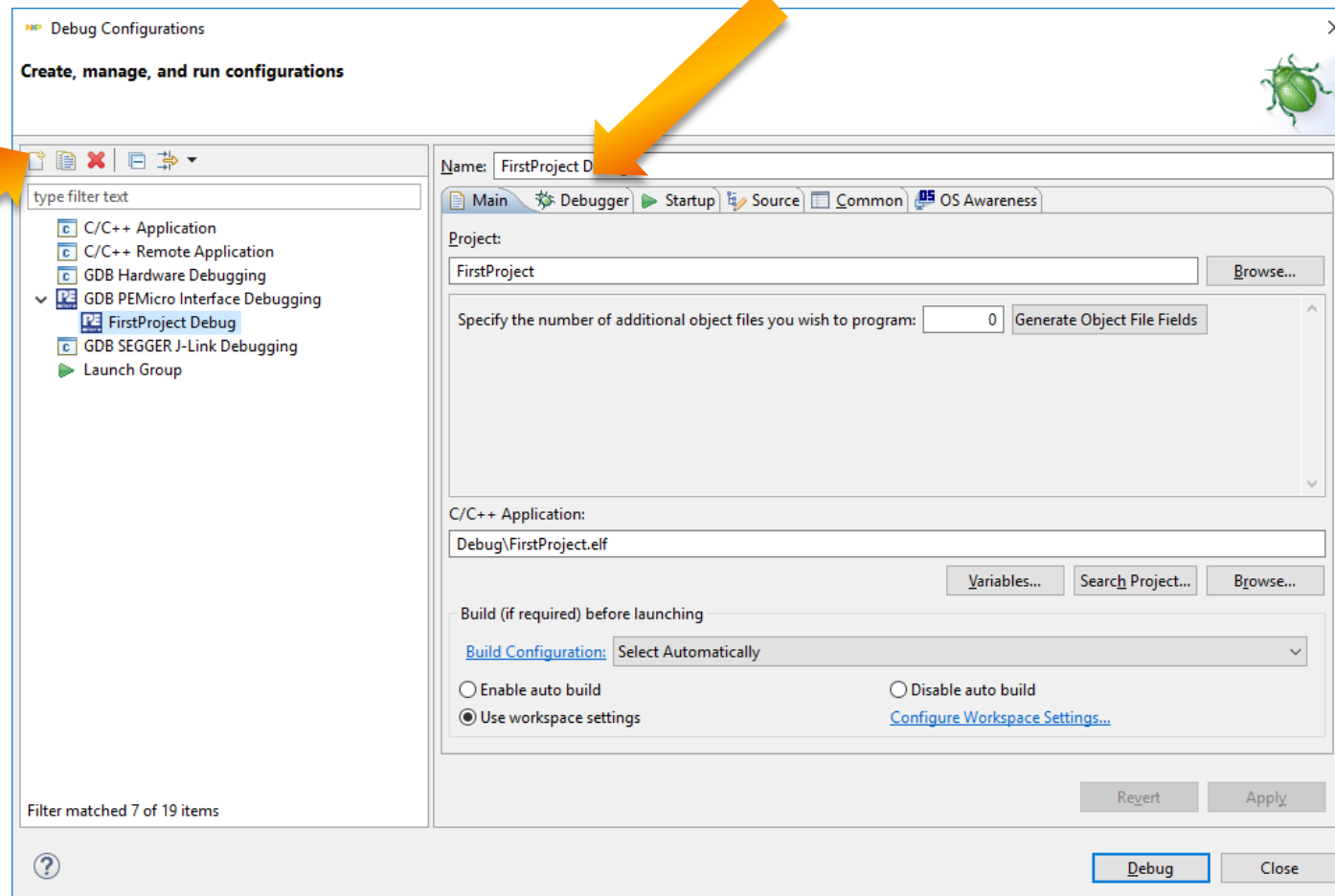

New P&E debug configuration

- Select the device

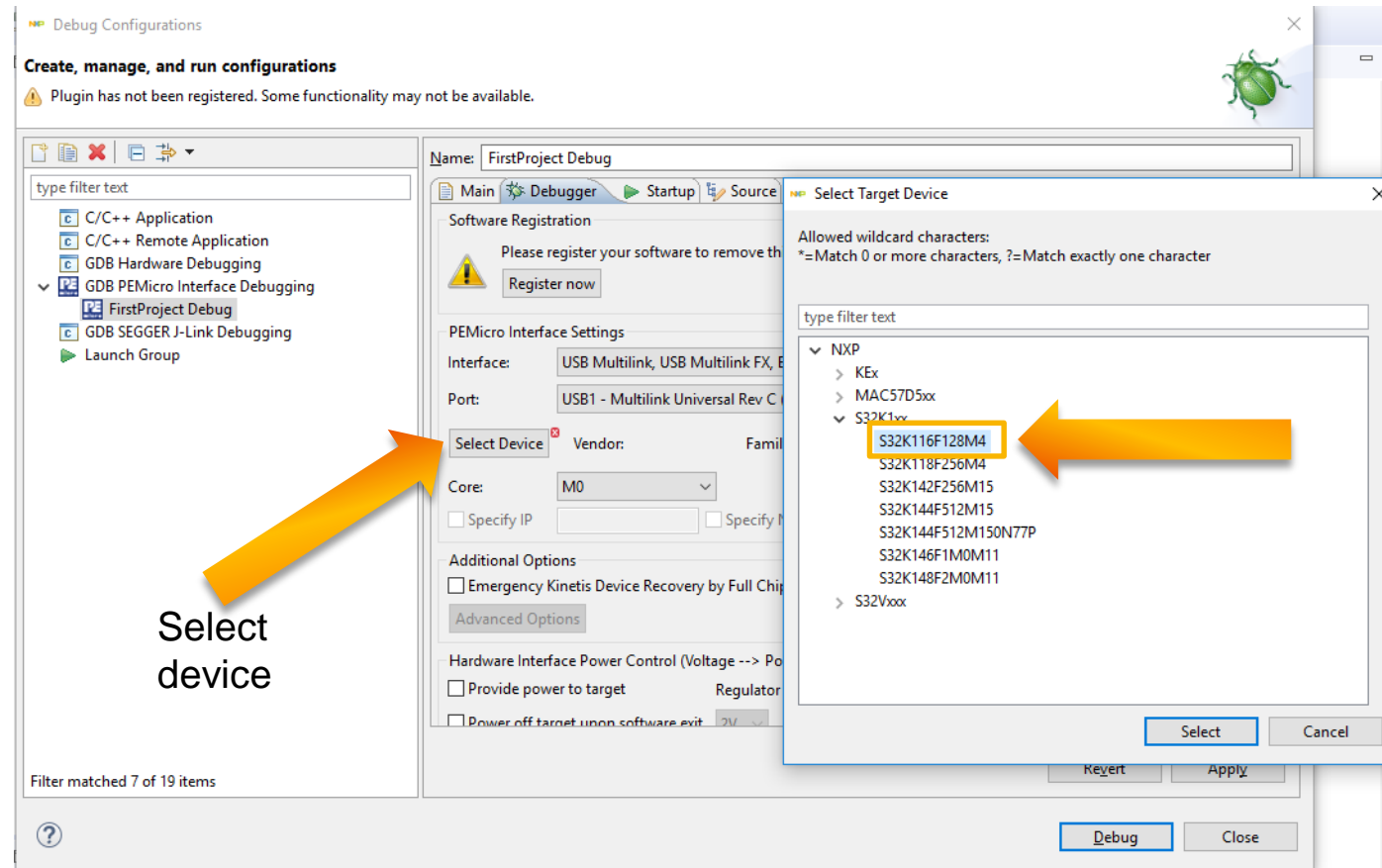

- Click Apply and debug your application

USEFUL LINKS



Useful Links

- [Cookbook application note](#). This application note contains a bunch of simple examples of how to use different peripherals.
- [S32K1xx community](#). Visit this site for request support on the S32K1xx products, you can also look for threads that may contain the answer that you are looking for.