





# SPECIFICATIONS

**CUSTOMER** : \_\_\_\_\_  
**MODEL NO.** : **GFT043FA480272**  
**VERSION** : **D**  
**DATE** : **2023.03.09**  
**CERTIFICATION** : **ROHS**

Customer Sign	Approved By	Prepared By	Prepared By
			

晶發科技股份有限公司  
GI FAR TECHNOLOGY CO.,LTD

新北市樹林區東豐街 81 號

No. 81, Dongfeng St, Shulin District, 238034, New Taipei City, Taiwan, R.O.C.

TEL: +886-2-8684-1188 FAX: +886-2-8684-8532





## Contents

### 1. SPECIFICATIONS

- 1.1 Features
- 1.2 Mechanical Specifications
- 1.3 Absolute Maximum Ratings
- 1.4 Dc Electrical Characteristics
- 1.5 Optical Characteristics
- 1.6 Backlight Characteristics

### 2. MODULE STRUCTURE

- 2.1 Counter Drawing
- 2.2 Interface Pin Description
- 2.3 Timing Characteristics

### 3. RELIABILITY TEST

### 4. PRECAUTION RELATING PRODUCT HANDLING

- 4.1 Safety
- 4.2 Handling
- 4.3 Storage
- 4.4 Terms of Warranty

Note : For detailed information please refer to IC data sheet:

Primacy (TFT LCD): Himax: HX8257(or Compatible IC)

### 5. OUTLINE DRAWING

Appendix : Inspection Standard



# 1. SPECIFICATIONS

## 1.1 Features

### Main LCD panel

Item	Standard Value
Display Type	480(R, G, B)* 272 Dots
LCD Type	a-Si TFT, Normally white, Transmissive type
Screen size (inch)	4.3 inch
Viewing Direction	6 O'clock
Color configuration	RGB-Strip
Backlight	LED B/L
Interface	Digital 24-bits RGB
Other (controller/driver IC)	HX8257 (Or Compatible IC)

## 1.2 Mechanical Specifications

Item	Standard Value	Unit
Outline Dimension	105.5(W)*67.2(L)*2.8(H)	mm

### LCD panel

Item	Standard Value	Unit
Active Area	95.04(W)*53.856(L)	mm

Note: For detailed information please refer to LCM drawing



### 1.3 Absolute Maximum Ratings

Item	Symbol	Condition	Min.	Max.	Unit
System Power Supply Voltage	VCC	GND=0	-0.3	5.0	V
	VGH-VGL	GND=0	-0.3	45.0	
Input Voltage*1	VI	-	-0.3	VCC+0.3	V
Operating Temperature	Top	-	-20	70	°C
Storage Temperature	T <sub>ST</sub>	-	-30	80	°C

### 1.4 DC Electrical Characteristics

(Unless otherwise specified, Voltage Referenced to DVSS, VDDIO = 2.2V, T<sub>A</sub> = 25°C)

Symbol	Parameter	Test condition	Spec.			Unit
			Min.	Typ.	Max.	
V <sub>DDIO</sub>	Power supply pin of IO pins	Recommend Operating Voltage Possible Operating Voltage	1.8	-	3.6	V
V <sub>CI</sub>	Booster Reference Supply Voltage Range	Recommend Operating Voltage Possible Operating Voltage	3 or VDDIO	-	3.6	V
I <sub>sleep</sub>	Sleep mode current	-	-	50	-	μA
I <sub>dp</sub>	Operating mode current	V <sub>CI</sub> =3.3V	-	13	15	mA
V <sub>CL</sub>	Negative V <sub>CI</sub> Output Voltage	No panel loading	- V <sub>CI</sub>	-	- V <sub>CI</sub> +0.7	V
V <sub>CIx2</sub>	V <sub>CIx2</sub> primary booster efficiency <sup>(1)</sup>	No panel loading, ITO for V <sub>CIx2</sub> , V <sub>CI</sub> and V <sub>CHS</sub> = 10 Ohm	5.2	5.4	5.6	V
V <sub>DC</sub>	V <sub>DC</sub> Output Voltage	V <sub>DC</sub> [3:0]=1011	4.9	5	5.1	V
V <sub>GH</sub>	Gate driver High Output Voltage Booster efficiency <sup>(2)</sup>	No panel loading; 3x booster	84	89.5	-	%
		No panel loading; 4x booster	80	88.5	-	%
V <sub>GL</sub>	Gate driver Low Output Voltage	V <sub>GL</sub> = -2 x V <sub>DC</sub>	-10	-10	-9	V
V <sub>COMH</sub>	V <sub>COMH</sub> High Output Voltage <sup>(3)</sup>	-	-3%	COMC+COMPP	3%	V
V <sub>COML</sub>	V <sub>COML</sub> Low Output Voltage <sup>(3)</sup>	-	-3%	COMC-COMPP	3%	V
V <sub>LCD</sub>	V <sub>LCD</sub> Output Voltage	V <sub>RH</sub> [5:0]=100100	4.41	4.51	4.61	V
V <sub>OH1</sub>	Logic High Output Voltage	I <sub>out</sub> = -100μA	0.9*V <sub>DDIO</sub>	-	V <sub>DD</sub>	V
V <sub>VD</sub>	Source Output Voltage Deviation	-	-	±20	±30	mV
V <sub>OS</sub>	Source Output Voltage Offset	-	-	-	±30	mV
V <sub>OL1</sub>	Logic Low Output Voltage	I <sub>out</sub> = 100μA	0	-	0.1*V <sub>DDIO</sub>	V
V <sub>IH1</sub>	Logic High Input voltage	-	0.8*V <sub>DDIO</sub>	-	V <sub>DDIO</sub>	V
V <sub>IL1</sub>	Logic Low Input voltage	-	0	-	0.2*V <sub>DDIO</sub>	V
I <sub>OH</sub>	Logic High Output Current Source	V <sub>out</sub> = V <sub>DD</sub> - 0.4V	50	-	-	μA
I <sub>OL</sub>	Logic Low Output Current Drain	V <sub>out</sub> = 0.4V	-	-	-50	μA
I <sub>OZ</sub>	Logic Output Tri-state Current Drain Source	-	-1	-	1	μA
I <sub>LIH</sub>	Logic Input Current	-	-1	-	1	μA

Note : (1) V<sub>CIx2</sub> efficiency = V<sub>CIx2</sub> / (2 x V<sub>CI</sub>) x 100%

(2) V<sub>GH</sub> efficiency = V<sub>GH</sub> / (V<sub>DC</sub> x n) x 100% (where n = booster factor)

(3) V<sub>COML</sub> < 0V, V<sub>COMH</sub> < V<sub>CIx2J</sub>



## 1.5 Optical Characteristics

### TFT LCD Module

VCC=3.3V Ta=25

°C

Item	Symbol	Condition	Min.	Typ	Max	Unit	
Response time	Rise	Tr	-	10	20	ms	Note2
	Fall	Tf	-	20	30		
Viewing angle	Top	$\theta Y+$	-	70	-	Deg.	Note4
	Bottom	$\theta Y-$	-	70	-		
	Left	$\theta X-$	-	40	-		
	Right	$\theta X+$	-	65	-		
Contrast ratio		CR	200	250	-	-	Note3
Color of CIE Coordinate (With B/L)	White	X	0.281	0.278	0.284	-	NoteA
		Y	0.282	0.276	0.288		
Average Brightness Pattern=white display (With B/L)		IV	120	140	-	cd/m <sup>2</sup>	NoteA
Uniformity (With B/L)*1		$\Delta B$	80	-	-	%	

Note A:

\*1:  $\Delta B = B(\min)/(max)$

\*2: Measurement Condition for Optical Characteristics:

a: Environment  $25^{\circ}\text{C} \pm 5^{\circ}\text{C} / 60 \pm 20\text{R.H}$ , no wind, dark room below 10 Lux at typical lamp current and typical operating frequency.

b: Measurement Distance  $500 \pm 50\text{mm}$  ( $\theta = 0^{\circ}$ )

c: Equipment: TOPCON BM-7 fast, (field  $1^{\circ}$ ), after 10 minutes operation.

d: The uncertainty of the C.I.E coordinate measurement  $\pm 0.01$ , Average Brightness  $\pm 4\%$

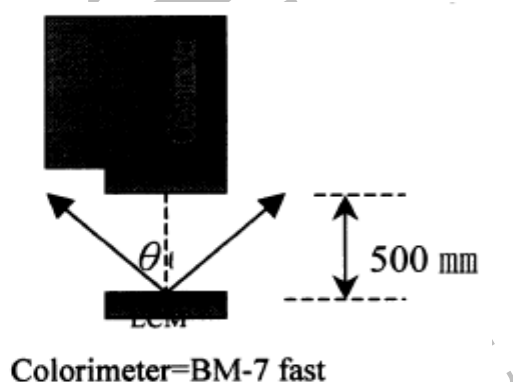
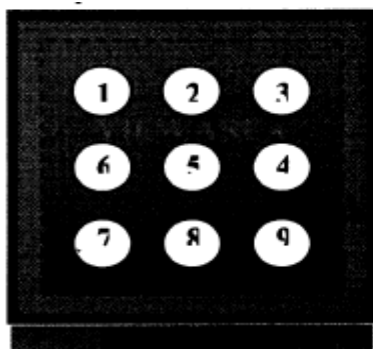





Note1: To be measured at the center area of panel with a viewing cone of 1° by Topcon

luminance meter BM-7, after 10 minutes operation (module)

Note2: Definition of response time:

The output signals of photo detector are measured when the input signals are changed from "black" to "white" (falling time) and from "white" to "black" (rising time). respectively. The response time is defined as the time interval between the 10% and 90% of Amplitudes.

Refer to figure as below:

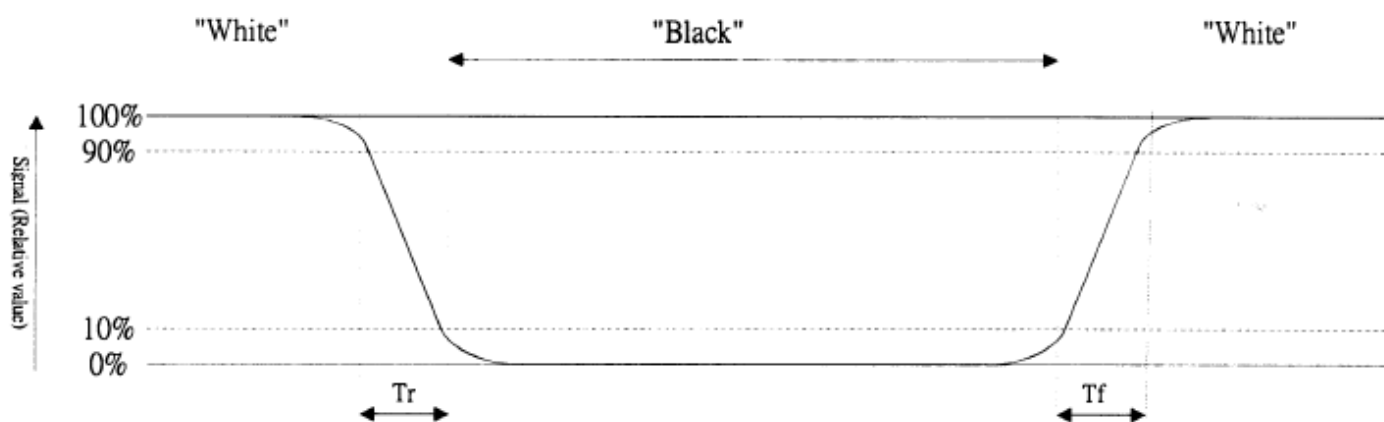

Note3: Definition of contrast ratio:

Contrast ratio is calculated with the following formula

$$\text{Contrast ratio (CR)} = \frac{\text{Photo detector output when LCD is at "White" state}}{\text{Photo detector output when LCD is at "Black" state}}$$

Note4: Definition of viewing angle

Refer to figure as below:

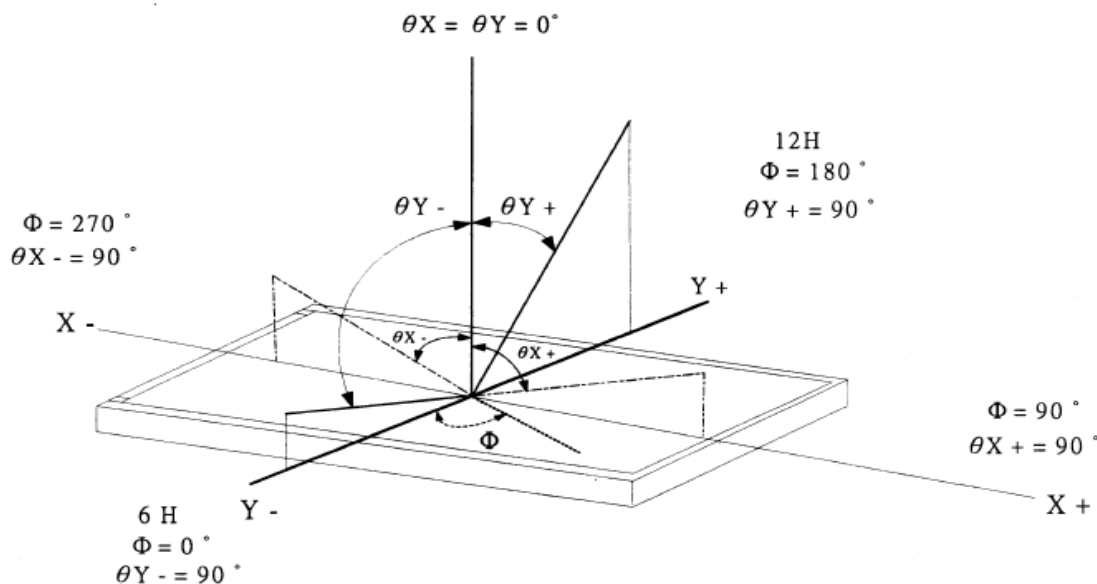



## 1.6 Backlight Characteristics

### Maximum Ratings

Item	Symbol	Conditions	Min.	Max	Unit
LED Forward Current	IF	Ta=25°C	-	20	mA
LED Reverse Voltage	VR	Ta=25°C	-	5	V

### Electrical / Optical Characteristics

Item	Symbol	Conditions	Min.	Typ.	Max.	Unit
Forward Voltage	VF	IF=20mA	21.1	23.1	25.2	V
Average Brightness (Without LCD)	IV		1200		-	cd/m <sup>2</sup>
CIE Color Coordinate (Without LCD)	X		0.265	0.29	0.315	-
	Y	0.265	0.29	0.315		
Color		White				

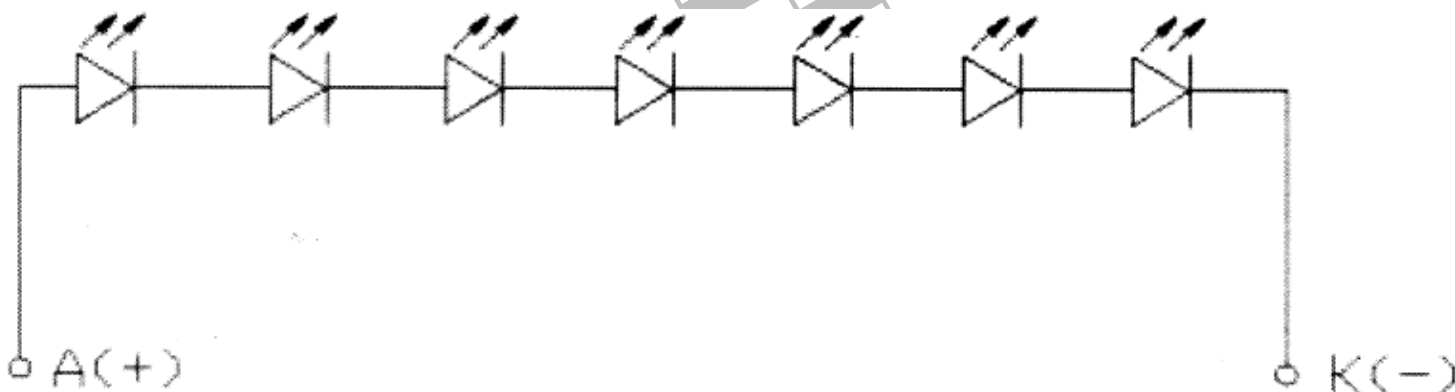





## 2. MODULE STRUCTURE

### 2.1 Counter Drawing

#### LCM Mechanical Diagram

- See Appendix

#### 2.1.2 Block diagram

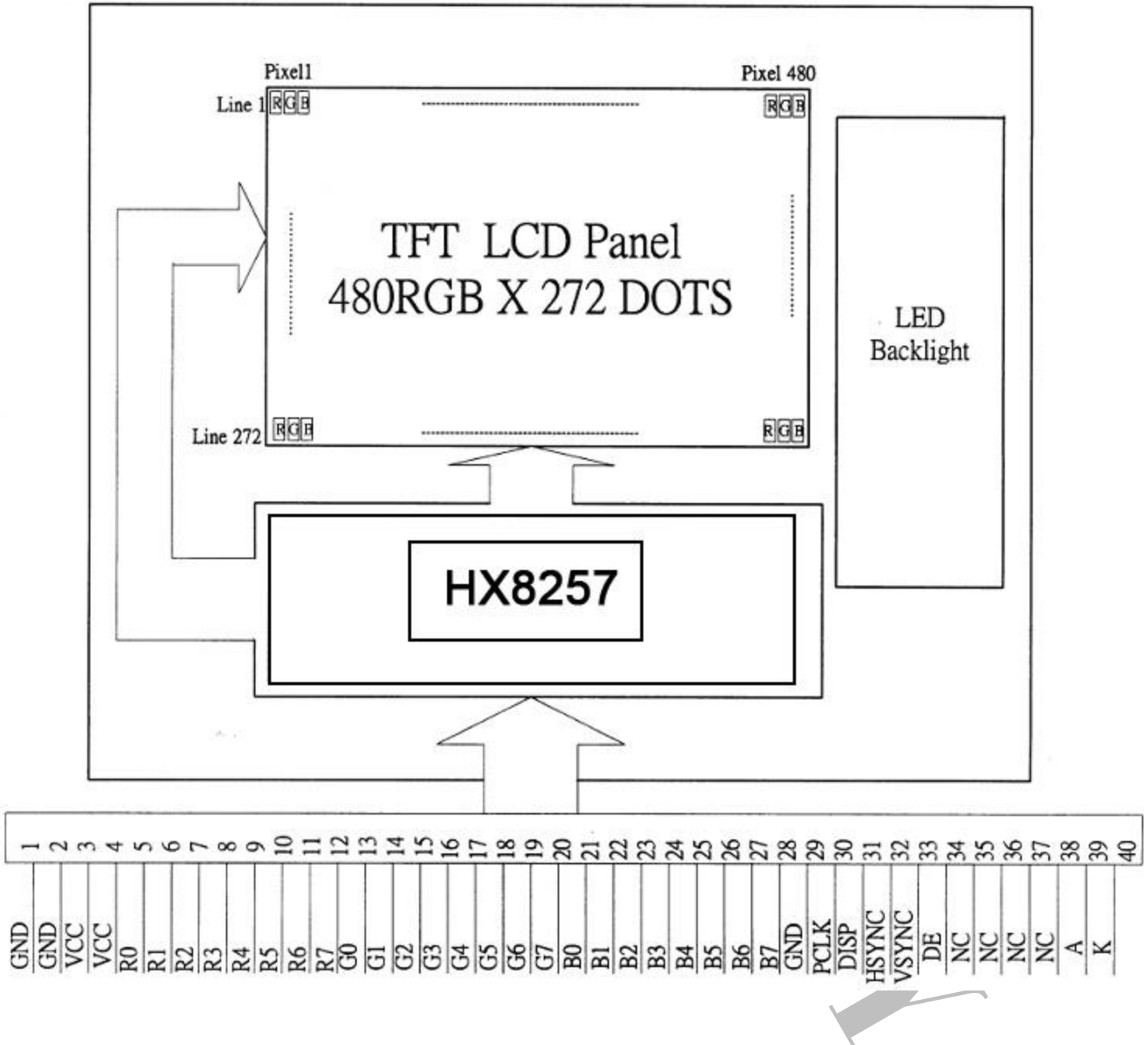



## 2.2 Interface Pin Description

Pin No.	Symbol	Function
1	GND	Ground
2	GND	Ground
3	VCC	Digital power
4	VCC	Digital power
5	R0	Red data bit 0
6	R1	Red data bit 1
7	R2	Red data bit 2
8	R3	Red data bit 3
9	R4	Red data bit 4
10	R5	Red data bit 5
11	R6	Red data bit 6
12	R7	Red data bit 7
13	G0	Green data bit 0
14	G1	Green data bit 1
15	G2	Green data bit 2
16	G3	Green data bit 3
17	G4	Green data bit 4
18	G5	Green data bit 5
19	G6	Green data bit 6
20	G7	Green data bit 7
21	B0	Blue data bit 0
22	B1	Blue data bit 1
23	B2	Blue data bit 2
24	B3	Blue data bit 3
25	B4	Blue data bit 4
26	B5	Blue data bit 5
27	B6	Blue data bit 6
28	B7	Blue data bit 7
29	GND	Ground
30	PCLK	Dot data clock
31	DISP	Display on / off mode control.
32	HSYNC	Horizontal sync input
33	VSYNC	Vertical sync input
34	DE	Data enable control
35	NC	No connection
36	NC	No connection
37	NC	No connection
38	NC	No connection
39	A	Power supply for LED Backlight anode input
40	K	Power supply for LED Backlight cathode input



## 2.3 Timing Characteristics

### Timing Parameters 1

(480RGBx272, TA=25°C, VCC=3.3to 3.6V, GND=0V)

PARAMETER	Symbol	Min.	Typ.	Max.	Unit
Clock cycle	f	-	9	15	MHz
Hsync cycle	1/th	-	17.14	-	KHz
Vsync cycle	1/th	-	59.94	-	Hz
Horizontal Signal					
Horizontal cycle	th	-	525	-	CLK
Horizontal display period	thd	-	480	-	CLK
Horizontal front porch	thf	2	2	82	CLK
Horizontal pulse width	thp	2	41	41	CLK
Horizontal back porch	thb	2	2	41	CLK
Vertical Signal					
Vertical cycle	tv	285	286	399	H
Vertical display period	tvd	-	272	-	H
Vertical front porch	tvf	1	2	227	H
Vertical pulse width	tvp	1	10	11	H
Vertical back porch	tvb	1	2	11	H

Note: (1) The table is parallel interface. Clock frequency and horizontal signal parameters are tripled in serial interface.

The maximum clock frequency of serial interface is 33MHz

(2) thd= 480CLK, thf=2CLK, thp=41CLK, thb=2CLK, thf+thp+thb>44CLK  
(CLK=1/fCLK, H=th)



Timing Chart 1

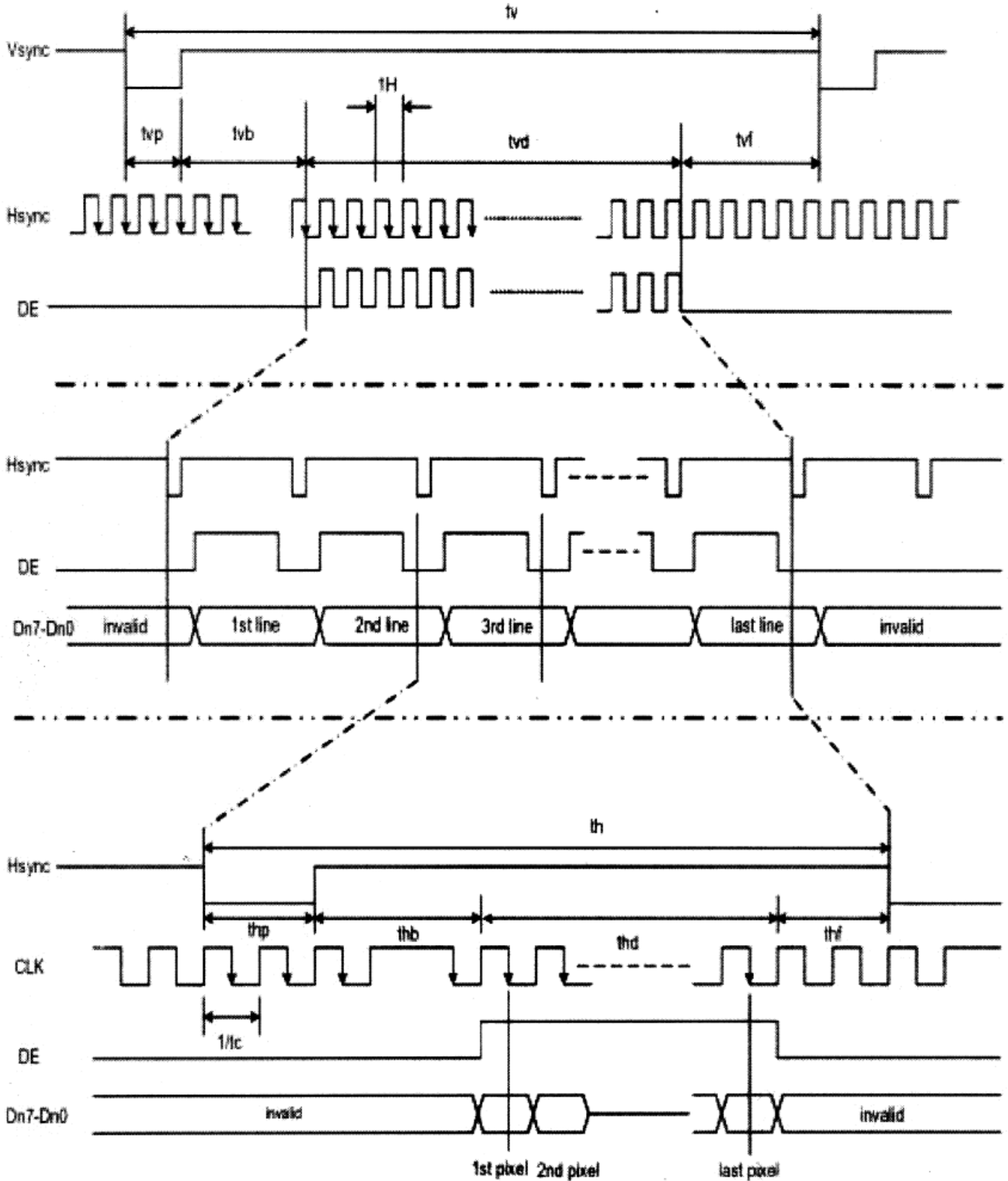



## Timing Parameters 2

( $T_A=25^{\circ}\text{C}$ ,  $V_{CC}=3.3\text{V}$  to  $3.6\text{V}$ ,  $GND=0\text{V}$ ,  $t_r^{(2)}=t_f^{(2)}=2\text{ns}$ )

PARAMETER	Symbol	Min.	Typ.	Max	Unit
DISP setup time	$t_{diss}$	10	-	-	ns
DISP hold time	$t_{dish}$	10	-	-	ns
Clock period	$PW_{CLK}^{(1)}$	66.7	-	-	ns
Clock pulse high period	$PWH^{(1)}$	26.7	-	-	ns
Clock pulse low period	$PWL^{(1)}$	26.7	-	-	ns
Hsync setup time	$t_{hs}$	10	-	-	ns
Hsync hold time	$t_{hh}$	10	-	-	ns
Data setup time	$t_{ds}$	10	-	-	ns
Data hold time	$t_{dh}$	10	-	-	ns
DE setup time	$t_{des}$	10	-	-	ns
DE hold time	$t_{deh}$	10	-	-	ns
Vsync setup time	$t_{vhs}$	10	-	-	ns
Vsync hold time	$t_{vhh}$	10	-	-	ns

Note: (1) For parallel interface, maximum clock frequency is 15MHz.

(2)  $t_r$ ,  $t_f$  is defined 10% to 90% of signal amplitude.



Timing Chart 2

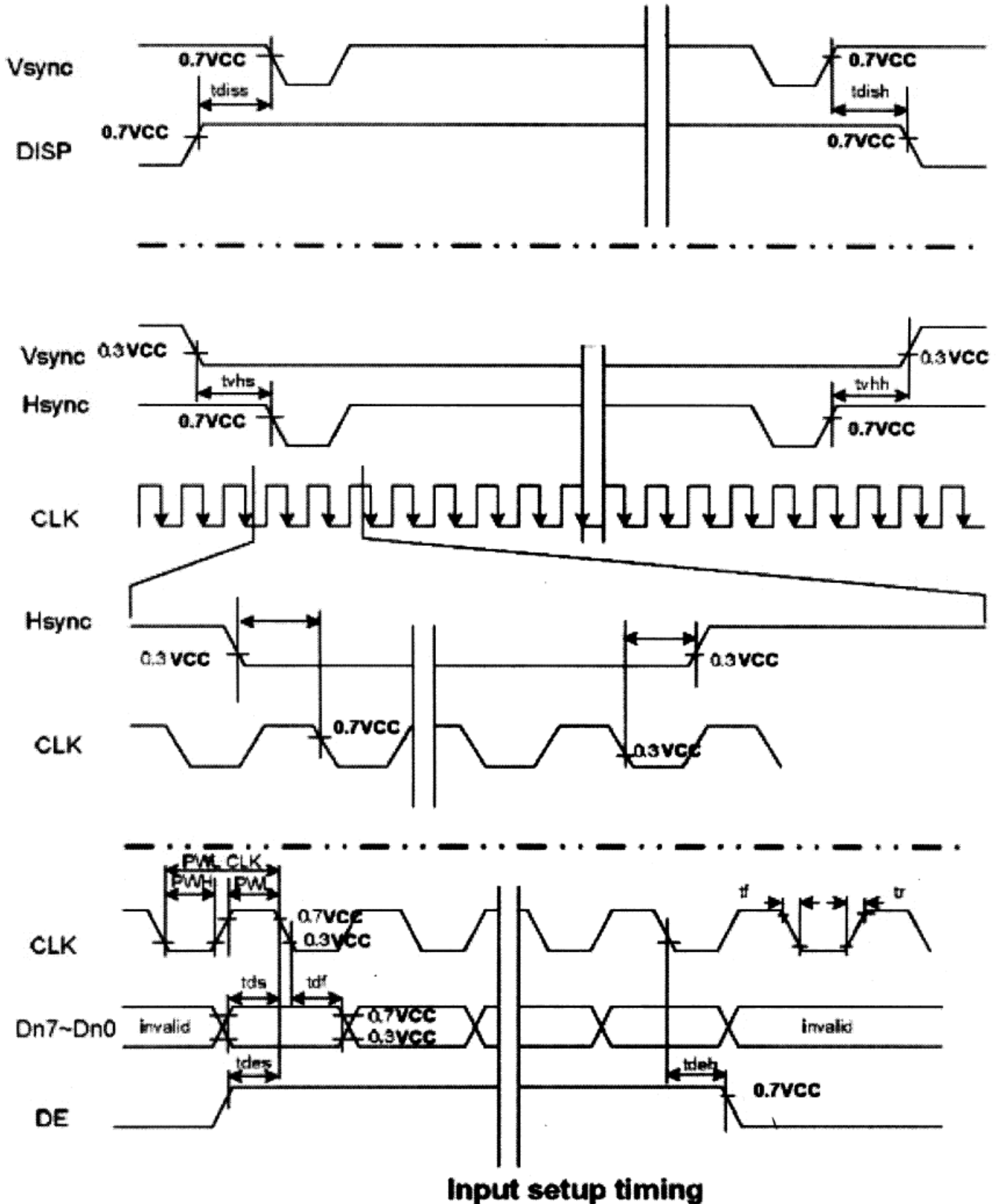





Color Data Assignment

COLOR	INPUT DATA	R DATA								G DATA								B DATA							
		R7	R6	R5	R4	R3	R2	R1	R0	G7	G6	G5	G4	G3	G2	G1	G0	B7	B6	B5	B4	B3	B2	B1	B0
		M S H							L S B	M S B							L S B	M S B							
BASIC COLOR	BLACK	0	0	0	0	0	0	0	0	0	0	0	0	0	0	0	0	0	0	0	0	0	0	0	0
	RED(255)	1	1	1	1	1	1	1	1	0	0	0	0	0	0	0	0	0	0	0	0	0	0	0	0
	GREEN(255)	0	0	0	0	0	0	0	0	1	1	1	1	1	1	1	1	0	0	0	0	0	0	0	0
	BLUE(255)	0	0	0	0	0	0	0	0	0	0	0	0	0	0	0	0	1	1	1	1	1	1	1	1
	CYAN	0	0	0	0	0	0	0	0	1	1	1	1	1	1	1	1	1	1	1	1	1	1	1	1
	MAGENTA	1	1	1	1	1	1	1	1	0	0	0	0	0	0	0	0	1	1	1	1	1	1	1	1
	YELLOW	1	1	1	1	1	1	1	1	1	1	1	1	1	1	1	1	0	0	0	0	0	0	0	0
	WHITE	1	1	1	1	1	1	1	1	1	1	1	1	1	1	1	1	1	1	1	1	1	1	1	1
RED	RED(0)	0	0	0	0	0	0	0	0	0	0	0	0	0	0	0	0	0	0	0	0	0	0	0	
	RED(1)	0	0	0	0	0	0	0	1	0	0	0	0	0	0	0	0	0	0	0	0	0	0	0	
	RED(2)	0	0	0	0	0	0	1	0	0	0	0	0	0	0	0	0	0	0	0	0	0	0	0	
	RED(254)	1	1	1	1	1	1	1	0	0	0	0	0	0	0	0	0	0	0	0	0	0	0	0	
	RED(255)	1	1	1	1	1	1	1	1	0	0	0	0	0	0	0	0	0	0	0	0	0	0	0	
GREEN	GREEN(0)	0	0	0	0	0	0	0	0	0	0	0	0	0	0	0	0	0	0	0	0	0	0	0	
	GREEN(1)	0	0	0	0	0	0	0	0	0	0	0	0	0	0	1	0	0	0	0	0	0	0	0	
	GREEN(2)	0	0	0	0	0	0	0	0	0	0	0	0	0	1	0	0	0	0	0	0	0	0	0	
	GREEN(254)	0	0	0	0	0	0	0	0	1	1	1	1	1	1	1	0	0	0	0	0	0	0	0	
	GREEN(255)	0	0	0	0	0	0	0	0	1	1	1	1	1	1	1	0	0	0	0	0	0	0	0	
BLUE	BLUE(0)	0	0	0	0	0	0	0	0	0	0	0	0	0	0	0	0	0	0	0	0	0	0	0	
	BLUE(1)	0	0	0	0	0	0	0	0	0	0	0	0	0	0	0	0	0	0	0	0	0	0	1	
	BLUE(2)	0	0	0	0	0	0	0	0	0	0	0	0	0	0	0	0	0	0	0	0	0	0	1	
	BLUE(254)	0	0	0	0	0	0	0	0	0	0	0	0	0	0	0	1	1	1	1	1	1	1	0	
	BLUE(255)	0	0	0	0	0	0	0	0	0	0	0	0	0	0	0	1	1	1	1	1	1	1	1	

Note (1) Definition of gray scale Color (n) : n means level of gray scale

Larger n means brighter level

(2) Data: 1-High, 0-Low



### 3. RELIABILITY TEST

NO.	ITEM	CONDITION		STANDARD	NOTE
1	High Temp. Storage	80°C	120 hrs	Appearance Without defect	
2	Low Temp. Storage	-30°C	120 hrs	Appearance Without defect	
3	High Temp. & High Humi. Storage	40°C 90% RH	120 hrs	Appearance Without defect	
4	High Temp. Operating Display	70°C	120 hrs	Appearance Without defect	
5	Low Temp. Operating Display	-20°C	120 hrs	Appearance Without defect	
6	Thermal Shock	-20°C, 30min. → 70°C, 30min. 		Appearance Without defect	10 cycles

\*\* Dissipation current, contrast and display functions

\*\* Polarizing filter deterioration, other appearance defects

\*\* The function test shall be conducted after 4hours storage at the normal temperature and humidity after remove from the test chamber.



## 4. PRECAUTION RELATING PRODUCT HANDLING

### 4.1 SAFETY

- 4.1.1 If the LCD panel breaks, be careful not to get the liquid crystal to touch your skin.
- 4.1.2 If the liquid crystal touches your skin or clothes, please wash it off immediately by using soap and water.

### 4.2 HANDLING

- 4.2.1 Avoid any strong mechanical shock which can break the glass.
- 4.2.2 Avoid static electricity which can damage the CMOS LSI-When working with the module, be sure to ground your body and any electrical equipment you may be using.
- 4.2.3 Do not remove the panel or frame from the module.
- 4.2.4 The polarizing plate of the display is very fragile. So, please handle it very carefully, do not touch, push or rub the exposed polarizing with anything harder than an HB pencil lead (glass, tweezers, etc.)
- 4.2.5 Do not wipe the polarizing plate with a dry cloth, as it may easily scratch the surface of plate.
- 4.2.6 Do not touch the display area with bare hands, this will stain the display area.
- 4.2.7 Do not use ketonics solvent & aromatic solvent. Use with a soft cloth soaked with a cleaning naphtha solvent.
- 4.2.8 To control temperature and time of soldering is  $320\pm 10^{\circ}\text{C}$  and 3-5 sec.
- 4.2.9 To avoid liquid (include organic solvent) stained on LCM.

### 4.3 STORAGE

- 4.3.1 Store the panel or module in a dark place where the temperature is  $25^{\circ}\text{C}\pm 5^{\circ}\text{C}$  and the humidity is below 65% RH.
- 4.3.2 Do not place the module near organics solvents or corrosive gases.
- 4.3.3 Do not crush, shake, or jolt the module.

### 4.4 TERMS OF WARRANTY

#### 4.4.1 Applicable warrant period

The period is within thirteen months since the date of shipping out under normal using and storage conditions.

#### 4.4.2 Unaccepted responsibility

This product has been manufactured to your company's specification as a part for use in your company's general electronic products. It is guaranteed to perform according to delivery specifications. For any other use apart from general electronic equipment, we cannot take responsibility if the product is used in nuclear power control equipment, aerospace equipment, fire and security systems or any other applications in which there is a direct risk to human life and where extremely high levels of reliability are required.



5. OUTLINE DRAWING:

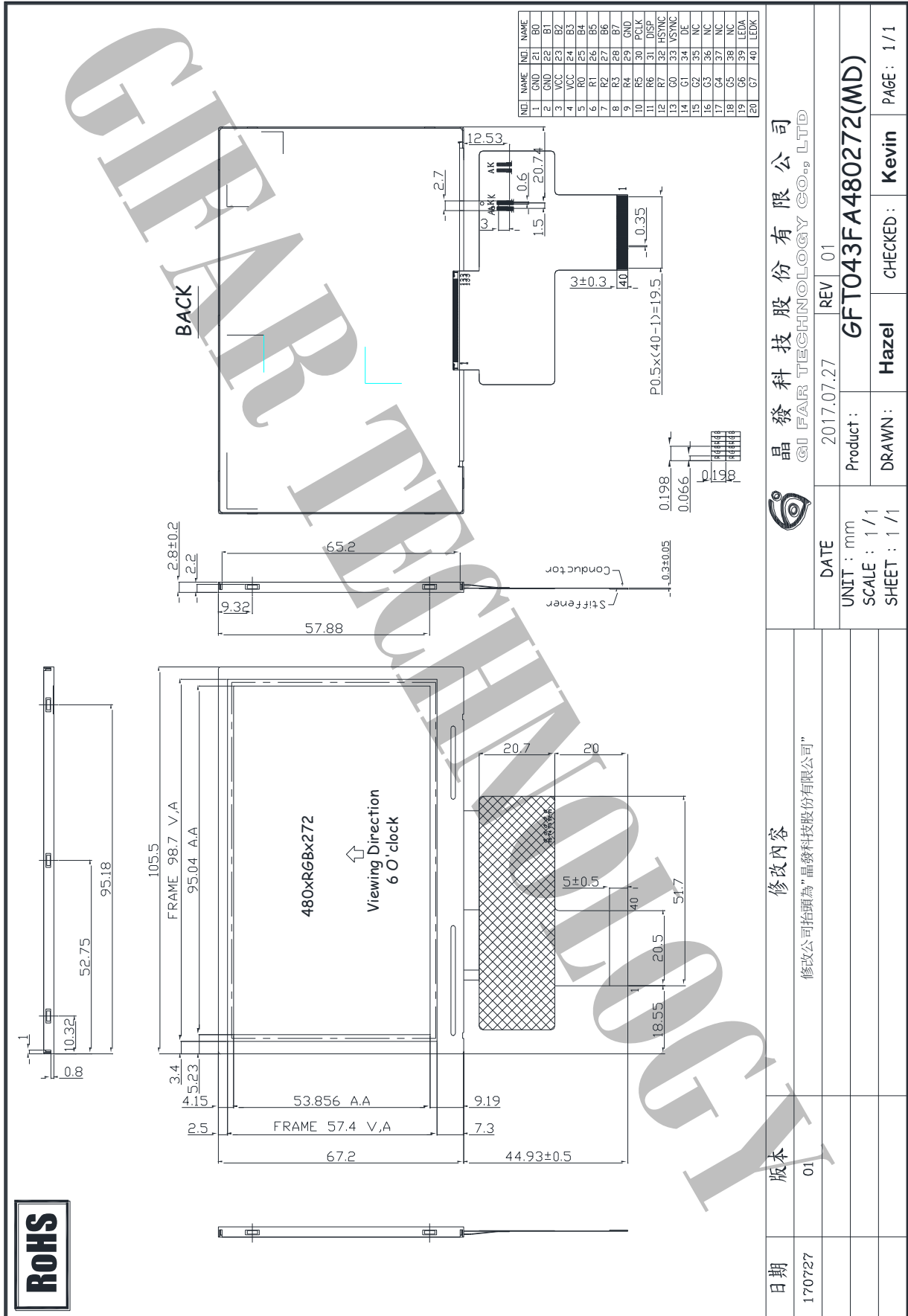

出貨檢驗標準書  
Shipping inspection standard

核准 Approved by	審核 Checked by	作成 Made by
ANDY	JACKY	RUBY

**1.目的 Purpose :**

規範出貨產品之檢驗項目及判斷標準，確保產品出貨能滿足客戶要求。

Standardize the inspection items and judgment standards to ensure the products that shipped out can meet customer's requirements.

**2.範圍 Area :**

適用於出廠之所有產品。

Applicable to all products shipped from the factory.

**3.名詞解釋 Explanation of terms :**

3-1 主要缺陷：亦會造成功能缺失或嚴重外觀缺陷。

Major Defects: It also causes loss of function or serious appearance defects.

3-2 次要缺陷：稍有缺陷但不影響客戶使用。

Minor defect: Slightly defective but does not affect customer use.

**4.檢驗體制 Inspection system :**

4-1 抽樣計劃：依 ANSI/ASQ Z1.4 一般檢驗水準 II 之 正常檢驗一次抽驗方案。

Sampling plan: According to ANSI/ASQ Z1.4 general inspection level II the normal inspection one-time sampling plan.

4-2 允收水準 Acceptable Level : (AQL)

主要缺陷 Major defect : 0.4 %

次要缺陷 Minor defect : 0.65 %

**5.檢驗條件 Inspection conditions :**

5-1 使用相關之檢測儀器及測試、量測工具。

Use relevant testing instrument, testing and measuring tools .

5-2 環境要求：其條件需控制在常溫下  $23^{\circ}\text{C}\pm 3^{\circ}\text{C}$  及溼度 70%RH 以下。

Environmental requirements: The conditions should be controlled at room temperature  $23^{\circ}\text{C}\pm 3^{\circ}\text{C}$  and humidity below 70%RH.

5-3 外觀檢驗：須在  $380\pm 20\%$  LUX 的白色日光燈下，其目視距離需於產品離  $30\pm 5$  cm 檢驗。

Appearance inspection: Under the white fluorescent lamp of  $380\pm 20\%$  LUX , the visual distance shall be checked above the product  $30 \pm 5$  cm.

5-4 電性測試 Electrical Testing :

5-4-1 有背光之產品需關燈並在  $5\sim 300\text{Lux}\pm 3\%$  下檢驗。

The products with backlight should be tested at  $5\sim 300\pm 3\%$  Lux.

5-4-2 無背光之產品需開燈並在  $60\sim 300\text{Lux}\pm 3\%$  白色日光燈下檢驗。

Products without backlight need to be turned on and tested under  $60\sim 300 \pm 3\%$  LUX white fluorescent lamps .

5-5 檢查視角依產品視角方向。

Check the viewing angle according to the product viewing angle.



5-6 其不良現象檢視區域 Bad phenomenon View area

5-6-1 適用種類 Applicable category : COB、TFT

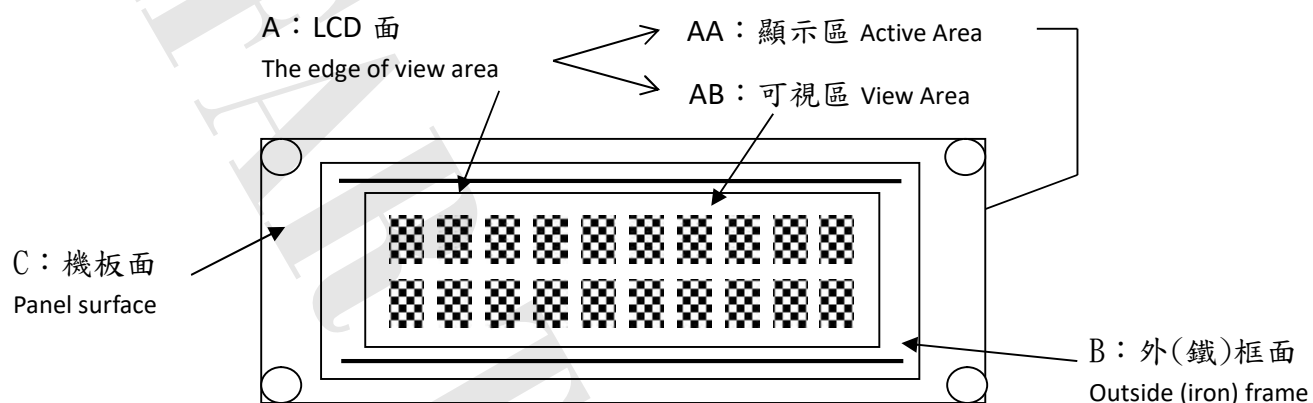

5-6-2 適用種類 Applicable category : COG、TAB、TN

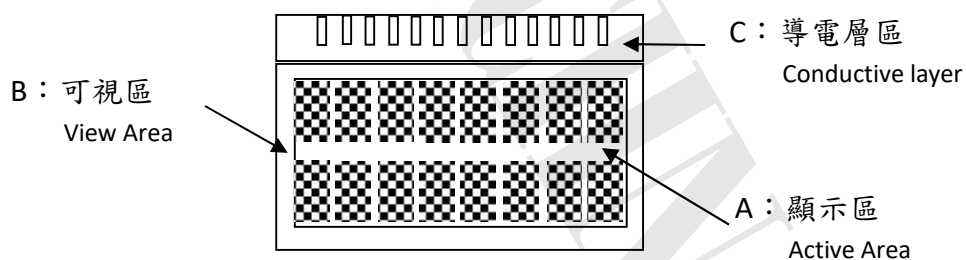

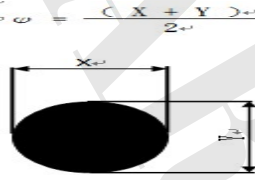
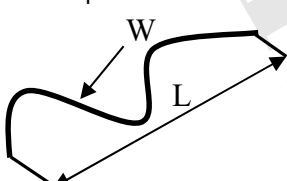
種類 Category		TFT																
編號 No.	檢驗項目 Item	檢驗內容及判定標準 Inspection Content & Standard	區域 Zone	類別 Category	缺陷等級 Level													
1	點類(一) Dot (1)	氣泡...圓狀 Bubble ...round shape 	兩點距離須超過 5 mm Two points have to be $\geq 5$ mm <table border="1"> <tr> <th><math>\phi</math> (mm)</th> <th>允收數 Acceptance Qty</th> </tr> <tr> <td><math>\phi \leq 0.25</math></td> <td>無視 Ignore</td> </tr> <tr> <td><math>0.25 &lt; \phi \leq 0.5</math></td> <td>3</td> </tr> <tr> <td><math>\phi &gt; 0.5</math></td> <td>0</td> </tr> </table>	$\phi$ (mm)	允收數 Acceptance Qty	$\phi \leq 0.25$	無視 Ignore	$0.25 < \phi \leq 0.5$	3	$\phi > 0.5$	0	A	外觀 Appearance	次要 Minor AQL0.65%				
$\phi$ (mm)	允收數 Acceptance Qty																	
$\phi \leq 0.25$	無視 Ignore																	
$0.25 < \phi \leq 0.5$	3																	
$\phi > 0.5$	0																	
2	線類 Line	刮傷、毛屑...等線狀 Scratch、Fiber.. and other linear shape. 	<table border="1"> <tr> <th>L (mm)</th> <th>W (mm)</th> <th>允收數 Acceptance Qty</th> </tr> <tr> <td>--</td> <td><math>W \leq 0.01</math></td> <td>無視 Ignore</td> </tr> <tr> <td><math>L \leq 3</math></td> <td><math>0.01 &lt; W \leq 0.05</math></td> <td>3</td> </tr> <tr> <td><math>L &gt; 3</math></td> <td><math>W &gt; 0.05</math></td> <td>0</td> </tr> </table>	L (mm)	W (mm)	允收數 Acceptance Qty	--	$W \leq 0.01$	無視 Ignore	$L \leq 3$	$0.01 < W \leq 0.05$	3	$L > 3$	$W > 0.05$	0	A	外觀 Appearance	次要 Minor AQL0.65%
L (mm)	W (mm)	允收數 Acceptance Qty																
--	$W \leq 0.01$	無視 Ignore																
$L \leq 3$	$0.01 < W \leq 0.05$	3																
$L > 3$	$W > 0.05$	0																
3	FPC 外觀 FPC Appearance	※ FPC 上刺傷導致線路無法導通 拒收 Stabbing on the FPC causes the line to fail to conduct Reject ※ FPC 上髒污或是殘留異物以致線路無法導通 拒收 Dirty or residual foreign matter on the FPC makes the circuit unable to conduct Reject ※ FPC 直角折痕、斷裂 拒收 FPC right-angle crease and fracture Reject	C	外觀 Appearance	次要 Minor AQL0.65%													
4	點類(二) Dot (2)	<table border="1"> <tr> <th>類型 Type</th> <th>允收數 Acceptance Qty</th> </tr> <tr> <td>亮點 Highlights</td> <td><math>N \leq 2</math></td> </tr> <tr> <td>暗點 dark spot</td> <td><math>N \leq 3</math></td> </tr> </table> ※ 缺陷點面積暫全點 1/2 則為一個缺陷點 Temporarily full area of defect point 1/2 is a defect point ※ 亮點：於黑畫面中使用 2% ND Filter 遮蓋須不可見 Highlights: Use 2% ND Filter in a black screen to cover up invisible ※ 暗點：在純紅、綠、藍模式下判定 Dark spot: judged in pure red, green and blue mode	類型 Type	允收數 Acceptance Qty	亮點 Highlights	$N \leq 2$	暗點 dark spot	$N \leq 3$	AA	電訊 Electronics	次要 Minor AQL0.65%							
類型 Type	允收數 Acceptance Qty																	
亮點 Highlights	$N \leq 2$																	
暗點 dark spot	$N \leq 3$																	

5	無動作 No reaction	顯示畫面一直處於起始畫面而無法進行切換 拒收 The display (view area) always shows in the initial screen and can't be switched to others. Reject	AA	電訊 Electronics	主要 Major AQL 0.4%
6	無畫面 No display	通電後，完全無任何畫面顯示 拒收 After connecting to the power, there is no display. Reject	AA	電訊 Electronics	主要 Major AQL 0.4%
7	斷線 Broken line	顯示畫面中少直、橫線 拒收 There is a lack of vertical or horizontal lines in the view area. Reject	AA	電訊 Electronics	主要 Major AQL 0.4%
8	I CON	顯示畫面缺少部份顯示圖案 拒收 Lack of partial ICON in the view area. Reject	AA	電訊 Electronics	主要 Major AQL 0.4%
9	深淺不一 Color difference	顯示畫面的對比，比其他顯示深或淺並依電氣規格(VOP)值判定 The contrast of display is obviously lighter or darker than others and according to the VOP value in the electronics specification. 拒收或與客端簽訂限度樣 Reject or inspect according to the golden sample	AA	電訊 Electronics	次要 Minor AQL0.65%
10	畫面異常 Abnormal screen	通電後畫面出現未定義之電訊不良現象 拒收 After connecting to the power, there is a undefined electronics appearance showing in the view area. Reject	AA	電訊 Electronics	主要 Major AQL 0.4%
11	牛頓環 Newton ring	點亮後目視有環、圓或曲線狀 拒收 There are rings, circles or curves visually after lighting Reject	A	電訊 Electronics	次要 Minor AQL0.65%
12	背光色不均 Uneven color of backlight	※ 點亮後 LED 有明暗不均現象依其均勻度判定 拒收 After lighting LEDs have brightness and darkness uneven the determined according to its uniformity. Reject ※ 點亮後 LED 色澤不一致 拒收 LED color is inconsistent after lighting Reject	A	電訊 Electronics	次要 Minor AQL0.65%
13	亮度不足 Lack of brightness	波長、色座標、輝度與圖面標示定義不符 拒收 Wave length, chromatic coordinates, brightness don't correspond to the definition of the drawing. Reject	A	電訊 Electronics	主要 Major AQL 0.4%

TFT

14	觸控 Touch	測試時無法點觸或劃，其靈敏度判定則依 SPEC 上定義判定 拒收 It cannot be touched or swiped during the test. Its sensitivity is judged according to the definition on SPEC Reject	A	電訊 Electronics	主要 Major AQL 0.4%
15	尺寸量測 Size Measurement	未依圖面上標示 拒收 No correspond to the indication on the drawing. Reject	ALL	外觀 Appearance	主要 Major AQL 0.4%
16	其他 Other	如發現有上述未定義之不良則與客端簽訂限度樣 If there is another undefined defective situation. It will be listed as others. The inspection standard is according to the golden sample.	ALL	電訊 Electronics 外觀 Appearance	次要 Minor AQL0.65%