

## Data sheet | Item number: 770-634

h-distribution connector; 3-pole; Cod. A; 1 input; 2 outputs; outputs on one side; 2 locking levers; black

[www.wago.com/770-634](http://www.wago.com/770-634)

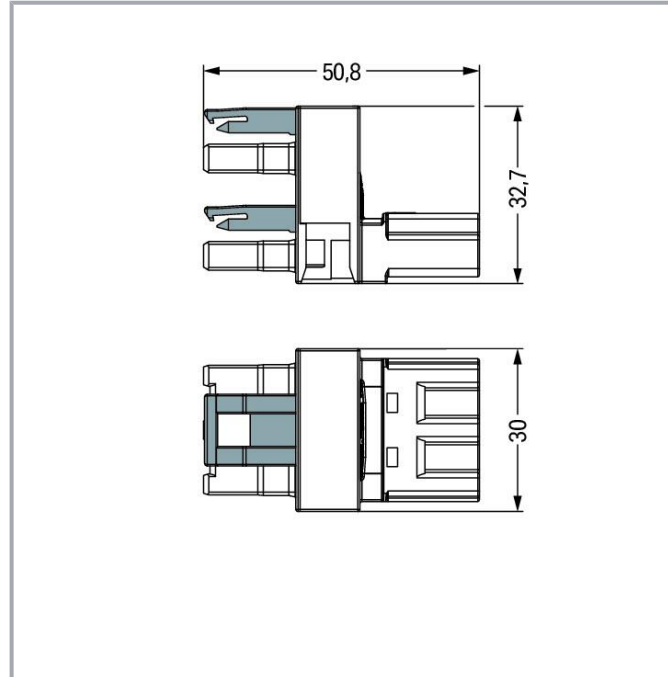

### Item description

#### Distribution connector **WINSTA®** MIDI rated current 25 A

For power and signal transmission: The **WINSTA®** MIDI distribution connector rated current 25 A. Our pluggable installation connectors with spring pressure connection technology work completely without screw connections. They allow flexible, error-free installation in numerous possible uses. The color coding and mechanical coding of the pluggable installation connector ensure error-free installation of the individual components – including protection against mismatching. The pluggable installation connector offers protection against contact with live components in accordance with protection type IP20 (When mated: IP2xC (These compact connectors are not designed for use in open, easily accessible areas!)). The **WINSTA®** MIDI pluggable installation connector with A coding in white or black is normally used for general mains applications in power distribution. This pluggable installation connector is used for electrical currents up to 25 A. Thus the product is also suitable for high power loads. **WINSTA®** MIDI with Push-in **CAGE CLAMP®** spring pressure connection technology is used in a broad range of individual products you can use for quick, easy and maximally flexible electrical installation.

Subject to changes. Please also observe the further product documentation!

WAGO GmbH & Co. KG  
Hansastr. 27  
32423 Minden  
Phone: +49571 887-0 | Fax: +49571 887-169  
Email: [info.de@wago.com](mailto:info.de@wago.com) | Web: [www.wago.com](http://www.wago.com)

Do you have any questions about our products?  
We are always happy to take your call at +49 (571) 887-44222.



## Push-in CAGE CLAMP® spring pressure connection technology – pluggable installation instead of laborious screw connections!

The WINSTA® Pluggable Connection System allows pluggable electrical installation. This saves time, lowers costs, and reduces the need for servicing. Take advantage of the pluggable version of our maintenance-free spring pressure connection technology too! Plan your installation with WINSTA® MIDI pluggable installation connectors with marking from WAGO.

- pluggable installation connectors with protection against mismatching
- pre-assembled versions
- suitable for any application
- ready to install and use immediately
- quick replacement of defective units during ongoing operation

### Data

#### Electrical data

#### Ratings per IEC/EN

Ratings per	IEC/EN 60664-1
Nominal voltage (III/3)	250 V
Rated impulse voltage (III/3)	4 kV
Rated current	25 A
Legend (ratings)	(III / 3) ≙ Overvoltage category III / Pollution degree 3

#### Ratings per UL 1977

Note for the US market	Some versions may also be used for current interruption in accordance with the UL certificate in select applications with currents below 16 A and voltages up to 600 V. For further information, please contact your local sales office.
Rated voltage (UL 1977)	600 V
Rated current UL 1977	23 A

#### General

Note on contact resistance	approx. 1 mΩ of contact resistance approx. 0.25 mΩ contact transition plug/socket
----------------------------	--

Subject to changes. Please also observe the further product documentation!



## Connection data

Total number of potentials	3
PE function	Preceding PE contact

## Connection 1

Pole number	3
-------------	---

## Physical data

Pin spacing	10 mm / 0.394 inches
Width	30 mm / 1.181 inches
Height	32.7 mm / 1.287 inches
Depth	51 mm / 2.008 inches

## Mechanical Data

Application	General mains applications
Coding	A
Marking	L $\perp$ N
Potential marking	L $\perp$ N
Mating force of a plug-in connection	approx. 20 ... 70 N (depending on pole number)
Retention force of a plug-in connection	When locked: > 80 N
Unmating force of a plug-in connection	Unlocked: approx. 20 ... 70 N (depending on pole number)
Number of mating cycles	200, without resistive load
Type of distribution box	h-distribution connector, outputs on one side
Protection type	IP20; When mated: IP2xC (These compact connectors are not designed for use in open, easily accessible areas!)

## Plug-in connection

Contact type (pluggable connector)	Socket/plug
Mismating protection	Yes
Note on mismating protection	All <i>WINSTA</i> <sup>®</sup> components are 100% protected against mismating when: a.) plugging different numbers of poles b.) plugging while rotated 180 c.) plugging while laterally staggered d.) plugging one pole
Locking lever	yes

Subject to changes. Please also observe the further product documentation!



Locking of plug-in connection

locking lever

Note on locking system

All connectors for mounted installations (snap-in versions for lighting fixtures or devices, all types of PCB and distribution connectors) are factory-equipped with locking levers to ensure plugs and sockets are securely locked. Additional locking levers are only required for flying leads (plug/socket).

## Material Data

Note (material data)

Information on material specifications can be found here

Color	black
Insulation material	Polyamide (PA66)
Flammability class per UL94	V0
Contact material	Copper or copper alloy; surface-treated
Contact plating	Tin
Fire load	0.534 MJ
Weight	22.4 g

## Environmental requirements

Processing temperature	-5 ... +40 °C
Continuous operating temperature	-35 ... +85 °C
Note on continuous operating temperature	Insulating parts for temperatures $\leq$ 105 °C

## Commercial data

eCl@ss 10.0	27-44-06-03
eCl@ss 9.0	27-44-06-03
ETIM 8.0	EC002567
ETIM 7.0	EC002567
PU (SPU)	50 pcs
Packaging type	box
Country of origin	DE
GTIN	4045454251437
Customs tariff number	85366990990

## Environmental Product Compliance

RoHS Compliance Status	Compliant, No Exemption
------------------------	-------------------------



Subject to changes. Please also observe the further product documentation!

WAGO GmbH & Co. KG  
 Hansastr. 27  
 32423 Minden  
 Phone: +49571 887-0 | Fax: +49571 887-169  
 Email: [info.de@wago.com](mailto:info.de@wago.com) | Web: [www.wago.com](http://www.wago.com)

Do you have any questions about our products?  
 We are always happy to take your call at +49 (571) 887-44222.

## Approvals / Certificates



### General approvals

Logo	Approval	Additional Approval Text	Certificate name
	CCA DEKRA Certification B.V.	EN 61535	71- 123228
	CCA DEKRA Certification B.V.	IEC 61535	NL -84761
	cURus Underwriters Laboratories Inc.	UL 1977	E45171

### Declarations of conformity and manufacturer's declarations

Logo	Approval	Additional Approval Text	Certificate name
	EU-Declaration of Conformity WAGO GmbH & Co. KG	-	-

### Approvals for marine applications

Logo	Approval	Additional Approval Text	Certificate name
	ABS American Bureau of Shipping	-	19- HG1868589- PDA
	DNV GL Det Norske Veritas, Germanischer Lloyd	-	TAE00001Z6
	LR Lloyds Register	IEC 61984	LR22429487TA

Subject to changes. Please also observe the further product documentation!

WAGO GmbH & Co. KG  
Hansastr. 27  
32423 Minden  
Phone: +49571 887-0 | Fax: +49571 887-169  
Email: [info.de@wago.com](mailto:info.de@wago.com) | Web: [www.wago.com](http://www.wago.com)

Do you have any questions about our products?  
We are always happy to take your call at +49 (571) 887-44222.

## Counterpart



**Item no. 770-103**  
Socket; with strain relief housing; 3-pole; Cod. A; 4,00 mm<sup>2</sup>; black

[www.wago.com/770-103](http://www.wago.com/770-103)



**Item no. 770-203**  
Socket; 3-pole; Cod. A; 4,00 mm<sup>2</sup>; black

[www.wago.com/770-203](http://www.wago.com/770-203)



**Item no. 770-113**  
Plug; with strain relief housing; 3-pole; Cod. A; 4,00 mm<sup>2</sup>; black

[www.wago.com/770-113](http://www.wago.com/770-113)



**Item no. 770-203/035-000**  
Socket; with strain relief housing; 3-pole; Cod. A; 4,00 mm<sup>2</sup>; black

[www.wago.com/770-203/035-000](http://www.wago.com/770-203/035-000)



**Item no. 770-213**  
Plug; 3-pole; Cod. A; 4,00 mm<sup>2</sup>; black

[www.wago.com/770-213](http://www.wago.com/770-213)



**Item no. 770-213/035-000**  
Plug; with strain relief housing; 3-pole; Cod. A; 4,00 mm<sup>2</sup>; black

[www.wago.com/770-213/035-000](http://www.wago.com/770-213/035-000)



**Item no. 771-9993/006-101**  
pre-assembled interconnecting cable; Eca; Socket/plug; 3-pole; Cod. A; H05VV-F 3G 1.5 mm<sup>2</sup>; 1 m; 1,50 mm<sup>2</sup>; black

[www.wago.com/771-9993/006-101](http://www.wago.com/771-9993/006-101)



**Item no. 771-9993/206-101**  
pre-assembled connecting cable; Eca; Plug/open-ended; 3-pole; Cod. A; H05VV-F 3G 1.5 mm<sup>2</sup>; 1 m; 1,50 mm<sup>2</sup>; black

[www.wago.com/771-9993/206-101](http://www.wago.com/771-9993/206-101)



**Item no. 771-9993/106-101**  
pre-assembled connecting cable; Eca; Socket/open-ended; 3-pole; Cod. A; H05VV-F 3G 1.5 mm<sup>2</sup>; 1 m; 1,50 mm<sup>2</sup>; black

[www.wago.com/771-9993/106-101](http://www.wago.com/771-9993/106-101)

## Optional accessories

### Mounting

#### Mounting accessories



**Item no.: 770-623**  
Mounting plate; 3-pole; for distribution connectors; Plastic; black

[www.wago.com/770-623](http://www.wago.com/770-623)



**Item no.: 770-673**  
Mounting plate; 3-pole; for distribution connectors; Plastic; white

[www.wago.com/770-673](http://www.wago.com/770-673)

### Cover

#### Cover

**Item no.: 770-360**

Subject to changes. Please also observe the further product documentation!

WAGO GmbH & Co. KG

Hansastr. 27

32423 Minden

Phone: +49571 887-0 | Fax: +49571 887-169

Email: [info.de@wago.com](mailto:info.de@wago.com) | Web: [www.wago.com](http://www.wago.com)

Do you have any questions about our products?

We are always happy to take your call at +49 (571) 887-44222.



Lockout cap; for plugs; 5-pole; separable; yellow

[www.wago.com/770-360](http://www.wago.com/770-360)



Item no.: 770-201

Lockout cap; 12-pole, separable; for sockets; Plastic; black

[www.wago.com/770-201](http://www.wago.com/770-201)



Item no.: 770-221

Lockout cap; 12-pole, separable; for sockets; Plastic; white

[www.wago.com/770-221](http://www.wago.com/770-221)

## Downloads

### Documentation

#### Bid Text

770-634 X81 - Datei	2019 Feb 19	xml 2.8 kB	Download
770-634 doc - Datei	2015 Mar 12	doc 23.6 kB	Download
ausschreiben.de 770-634		URL	Download

## CAD/CAE-Data

### CAD data

2D/3D Models 770-634	URL	Download
----------------------	-----	----------

### CAE data

EPLAN Data Portal 770-634	URL	Download
ZUKEN Portal 770-634	URL	Download
WSCAD Universe 770-634	URL	Download

## Environmental Product Compliance

### Compliance Search

Environmental Product Compliance 770-634	URL	Download
--	-----	----------

Subject to changes. Please also observe the further product documentation!

h-distribution connector; 3-pole; Cod. A; 1 input; 2 outputs; outputs on one side; 2 locking levers; black

## Installation Notes

### Installation

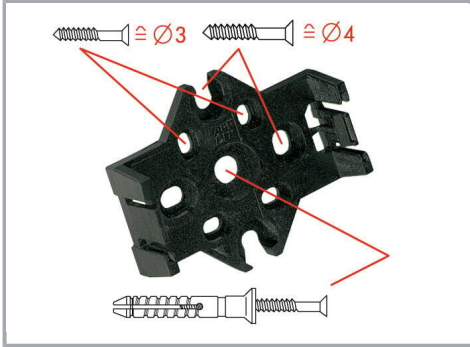

Mounting plates can be secured using commercially available screws or nail-drive anchors.



The distribution connectors snap together when attached to the mounting plate.



To release the distribution connector, unlock the latch using a screwdriver.

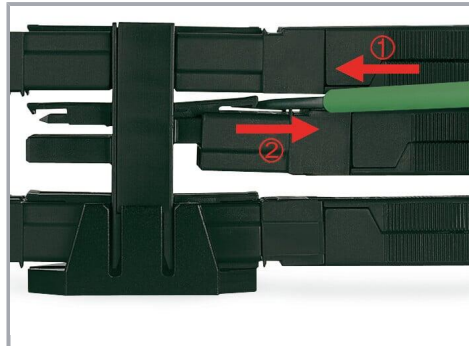

All distribution connector connections are locked and protected against accidental disconnection directly after mating. Locking of any connection is released using a screwdriver, even if all connections are used.

## Product family

**WINSTA® MIDI**

[Show all products from the family](#)

Subject to changes. Please also observe the further product documentation!