

**PLUG MATED TO R/A RECEPTACLE
MATED PROFILE**

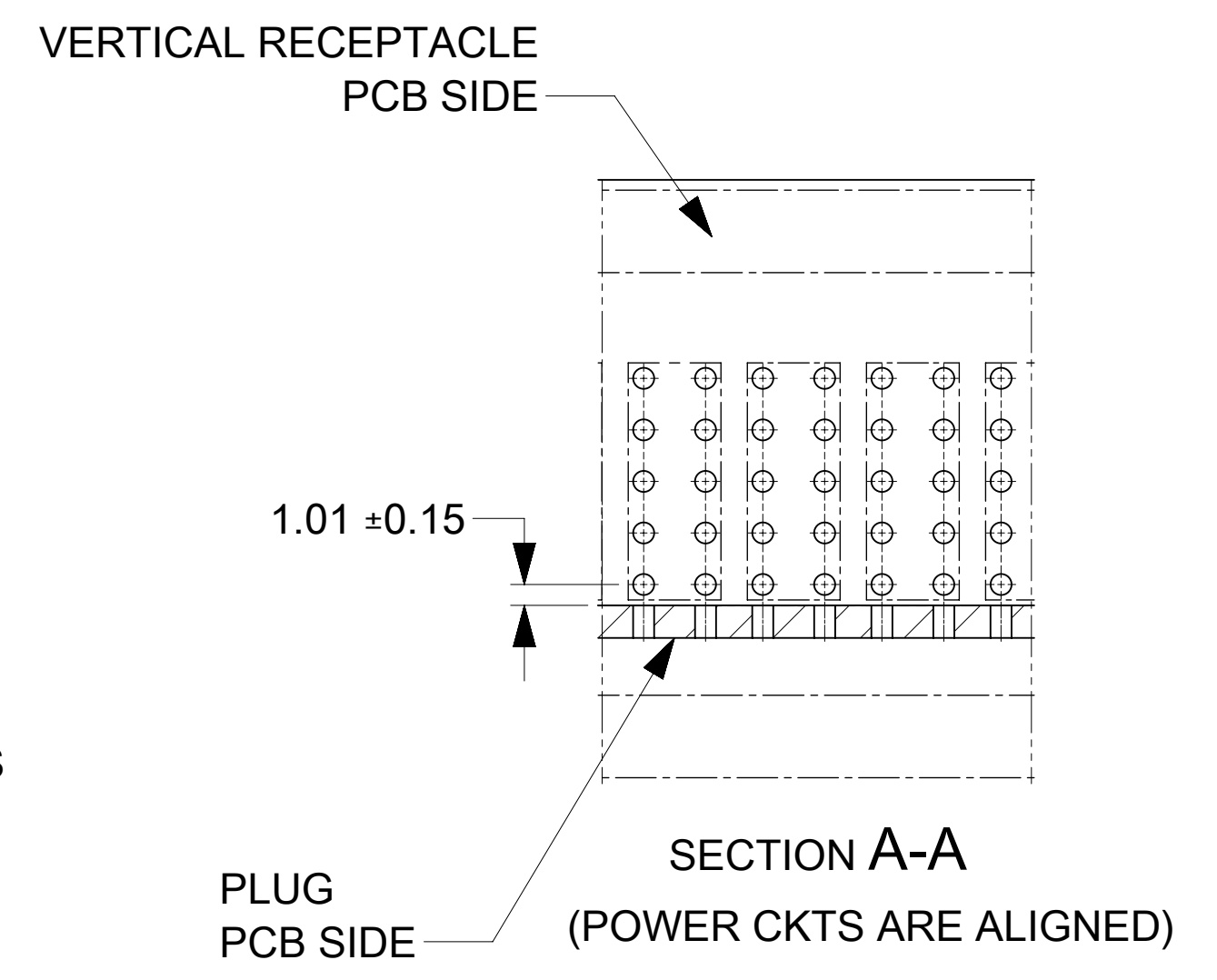

**PLUG MATED TO VERTICAL RECEPTACLE
MATED PROFILE**

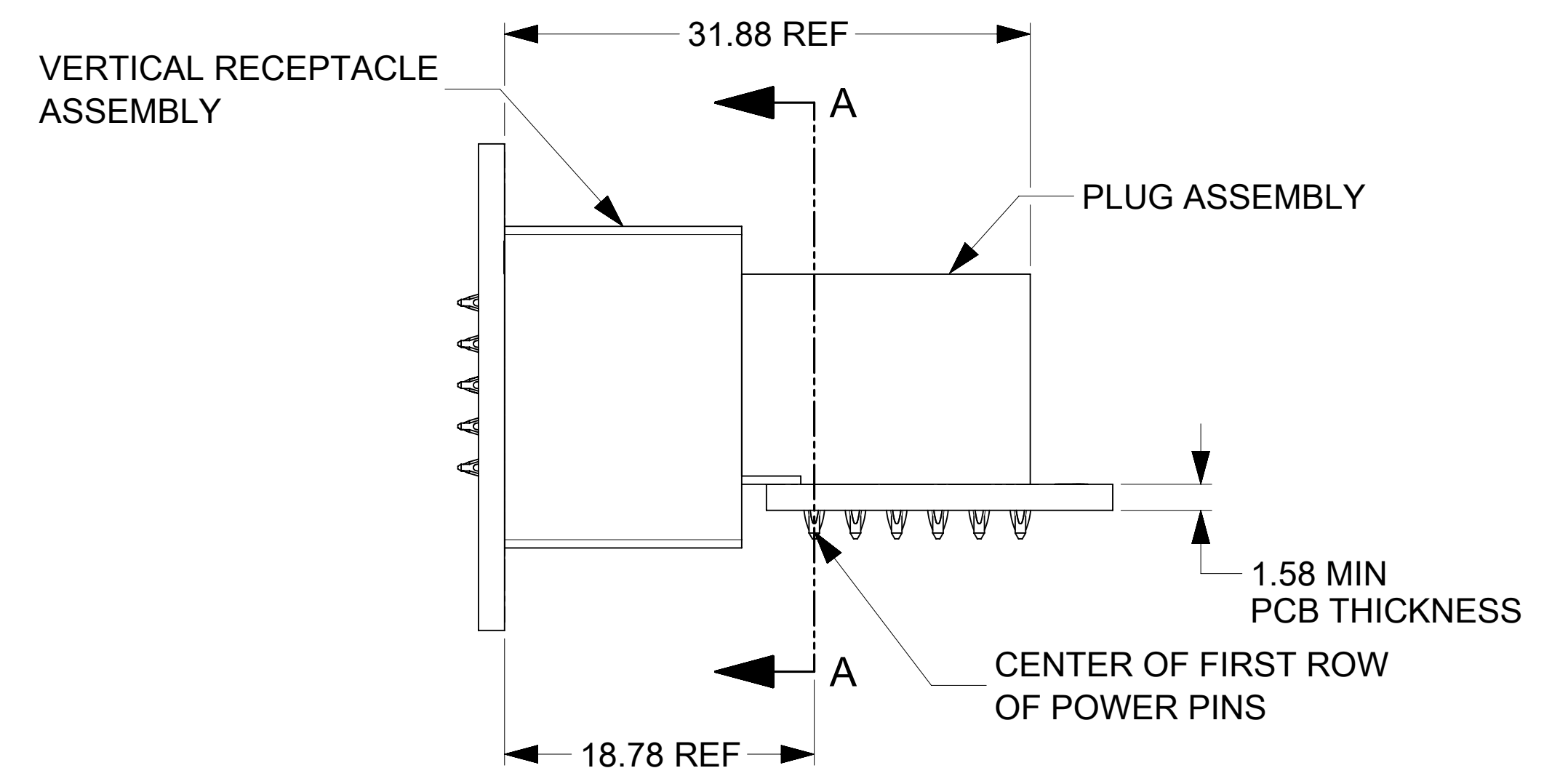
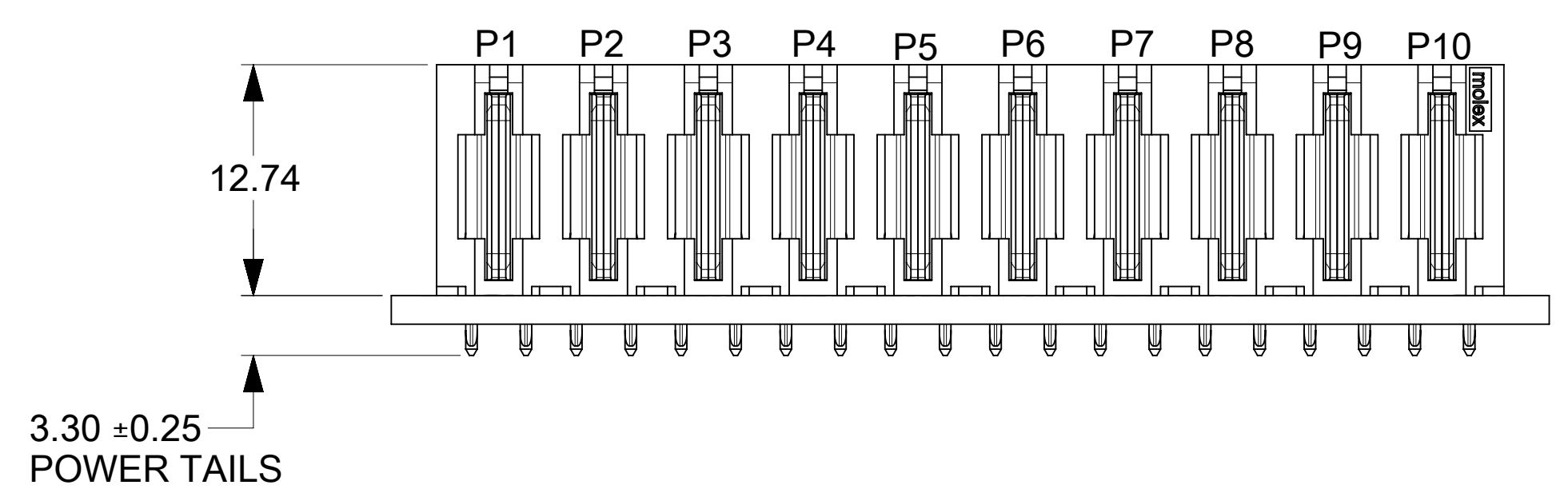
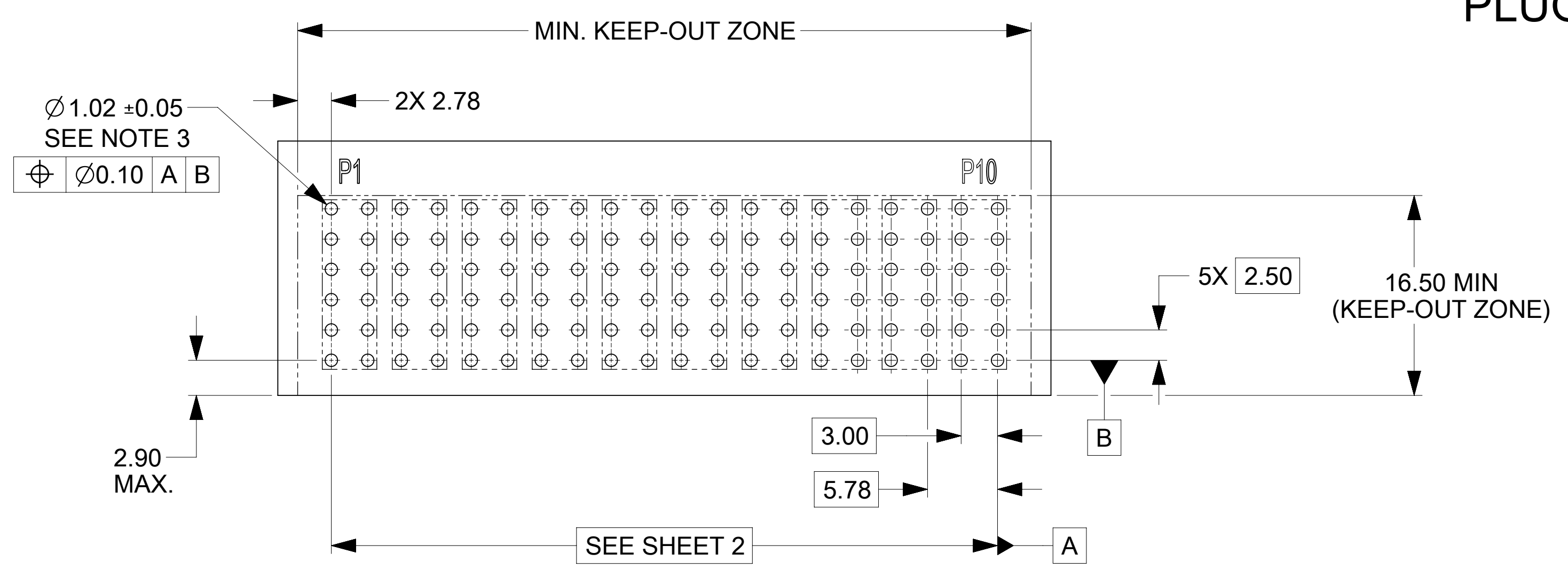

NOTES:

- MATERIAL:**
 - HOUSINGS: LCP UL94, V-0, COLOR : BLACK
 - TERMINALS: HIGH CONDUCTIVITY COPPER ALLOY
 - PLATING: 1.27 µm (50 µin) NICKEL OVERALL WITH 2.54 µm (100 µin) SELECTIVE TIN ON TAILS AND 0.762 µm (30 µin) SELECTIVE GOLD ON CONTACT AREA
- PACKAGING:** ASSEMBLIES TO BE TRAY PACKED PER PACKAGING SPEC: 2141130010-PK.
- PLATED THRU HOLE SIZE,** REFER TO PRODUCT SPEC. FOR DETAILS.
- PRODUCT SPEC:** 2141130000-PS.
- PRODUCT TO MEET** RoHS REQUIREMENTS.
- PLUG ASSEMBLY MATES TO MOLEX RECEPTACLES** 219563XXXX-SD AND 219564XXXX-SD, SEE DRAWINGS FOR DETAILS.
- TAIL DESIGN:** COMPLIANT PIN.
- POWER TERMINALS ARE LUBRICATED.**
- APPLICATION SPECIFICATION:** 2141130000-AS (FOR COMPLIANT TAILS ONLY).

RECOMMENDED PCB LAYOUT AND KEEP-OUT ZONE

THIS DRAWING CONTAINS INFORMATION THAT IS PROPRIETARY TO MOLEX ELECTRONIC TECHNOLOGIES, LLC AND SHOULD NOT BE USED WITHOUT WRITTEN PERMISSION			
DIMENSION UNITS	SCALE	CURRENT REV DESC:	
mm	3:1		
GENERAL TOLERANCES (UNLESS SPECIFIED)			
ANGULAR TOL	± °		
4 PLACES	±	EC NO: 745288	
3 PLACES	±	DRWN: LZABJANOVSKI	2023/03/21
2 PLACES	± 0.25	CHK'D: JAYK1	2023/04/10
1 PLACE	± 0.3	APPR: JAYK1	2023/04/10
0 PLACES	±	INITIAL REVISION:	
DRAFT WHERE APPLICABLE MUST REMAIN WITHIN DIMENSIONS		DRWN: LZABJANOVSKI	2022/03/29
		APPR: BPISZCZOR	2022/08/04
THIRD ANGLE PROJECTION	DRAWING	SERIES	MATERIAL NUMBER
	D-SIZE	219562	SEE CHART
		CUSTOMER	SHEET NUMBER
			1 OF 2

molex

GUARDIAN HD RA PLUG POWER ONLY
UNGUIDED PF

PRODUCT CUSTOMER DRAWING

DOCUMENT NUMBER	DOC TYPE	DOC PART	REVISION
2195629003-SD	PSD	000	A1

PART NUMBER	CONFIGURATION	QUANTITY PER CARTON (DU)
219562-0031	1P	656

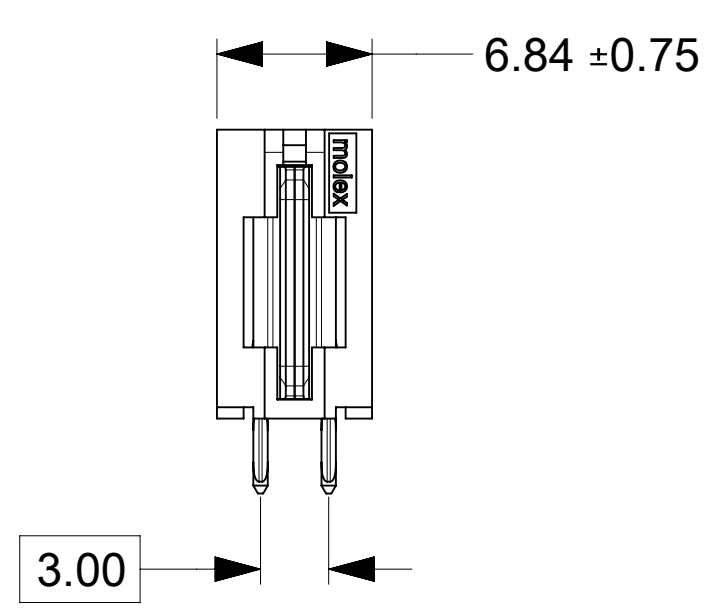

PART NUMBER	CONFIGURATION	QUANTITY PER CARTON (DU)
219562-0032	2P	352

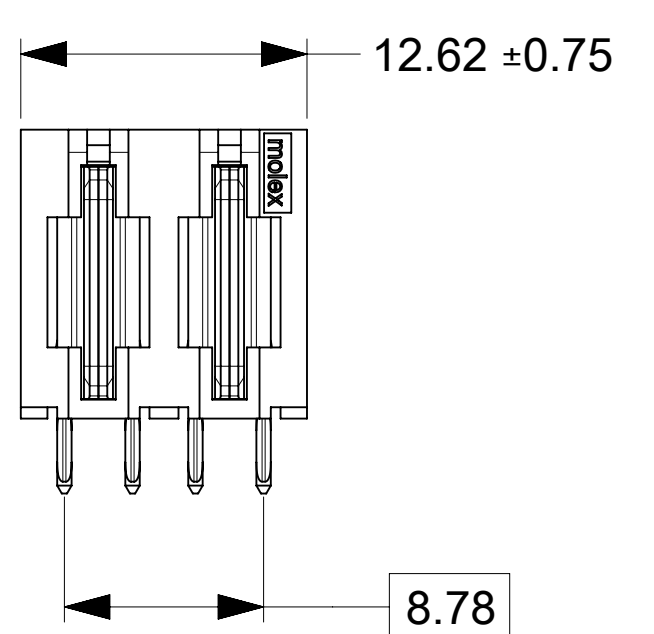

PART NUMBER	CONFIGURATION	QUANTITY PER CARTON (DU)
219562-0033	3P	240

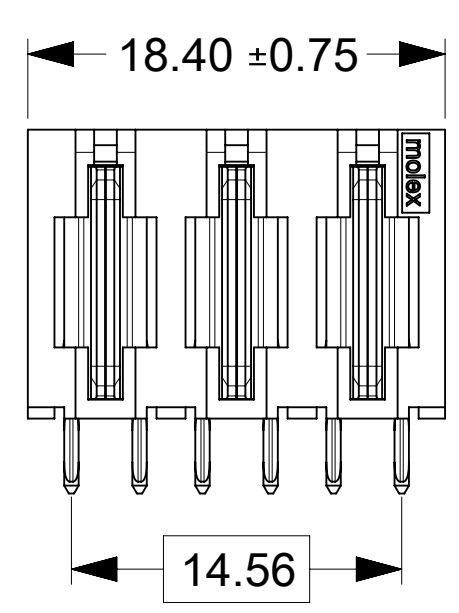

PART NUMBER	CONFIGURATION	QUANTITY PER CARTON (DU)
219562-0034	4P	176

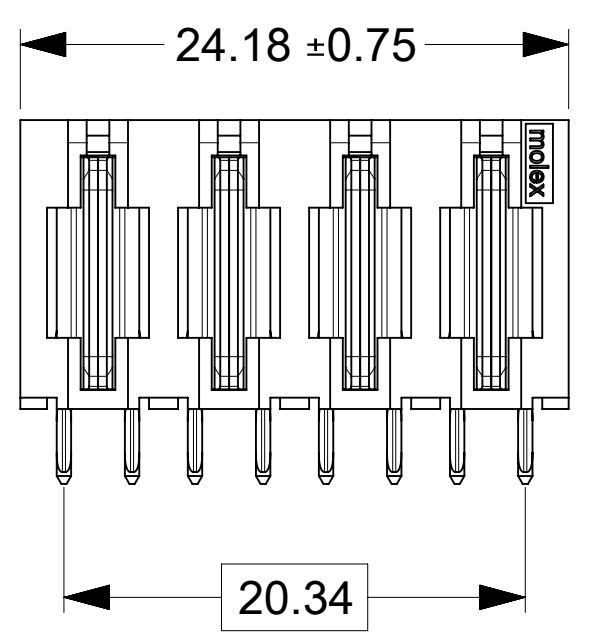

PART NUMBER	CONFIGURATION	QUANTITY PER CARTON (DU)
219562-0035	5P	144

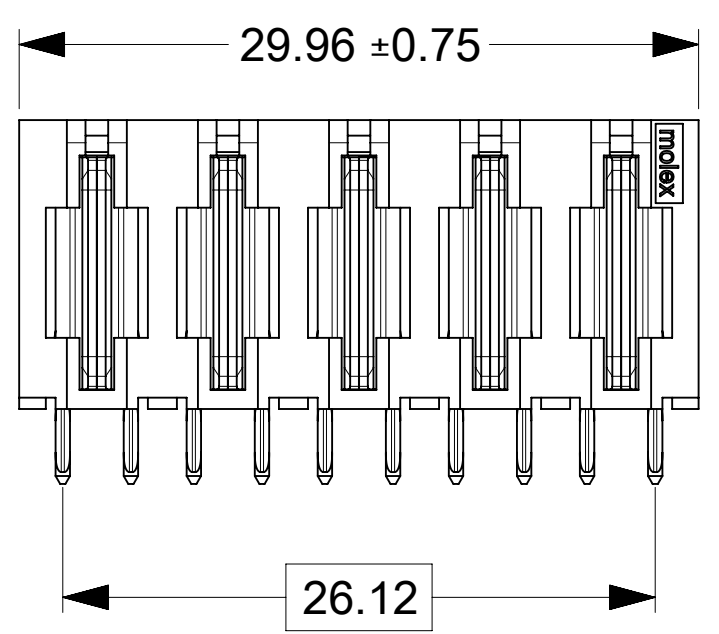

PART NUMBER	CONFIGURATION	QUANTITY PER CARTON (DU)
219562-0036	6P	112

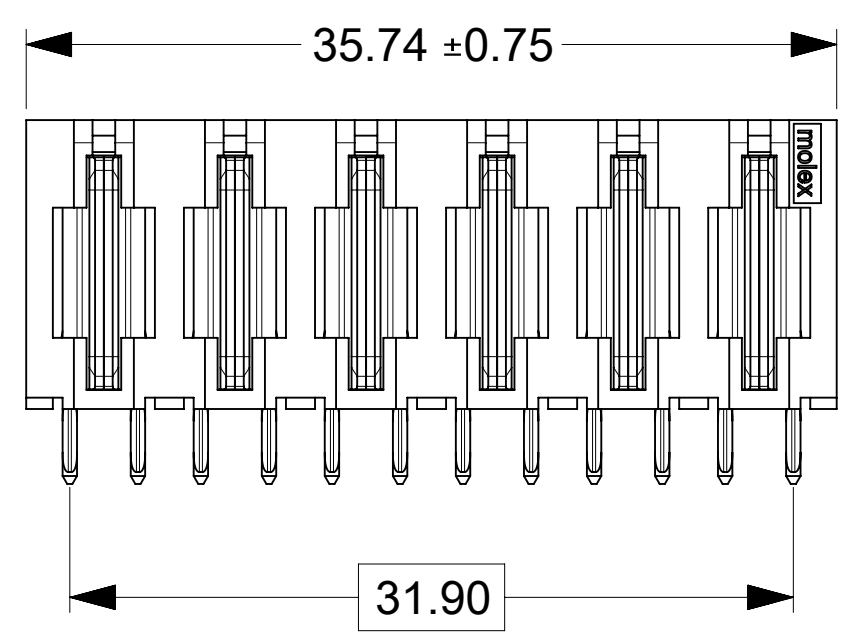

PART NUMBER	CONFIGURATION	QUANTITY PER CARTON (DU)
219562-0037	7P	96

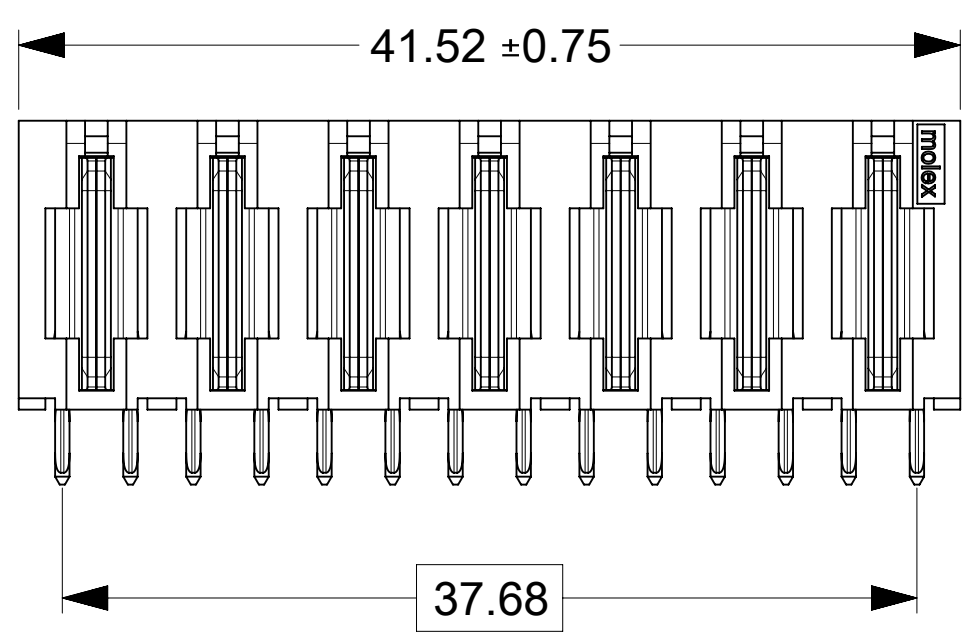

PART NUMBER	CONFIGURATION	QUANTITY PER CARTON (DU)
219562-0038	8P	96

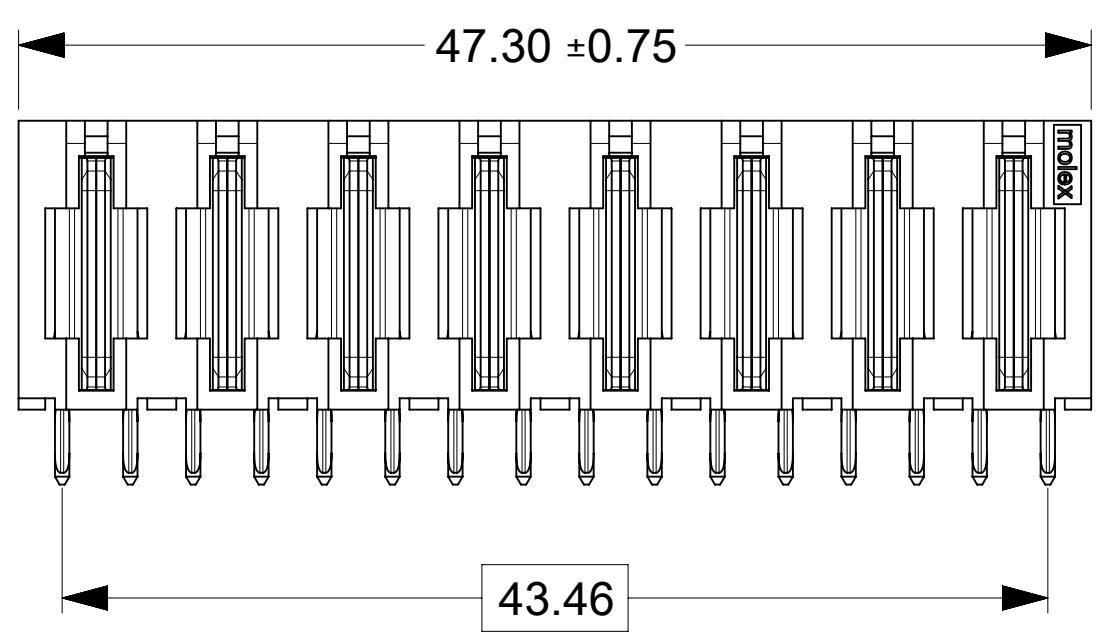

PART NUMBER	CONFIGURATION	QUANTITY PER CARTON (DU)
219562-0039	9P	80

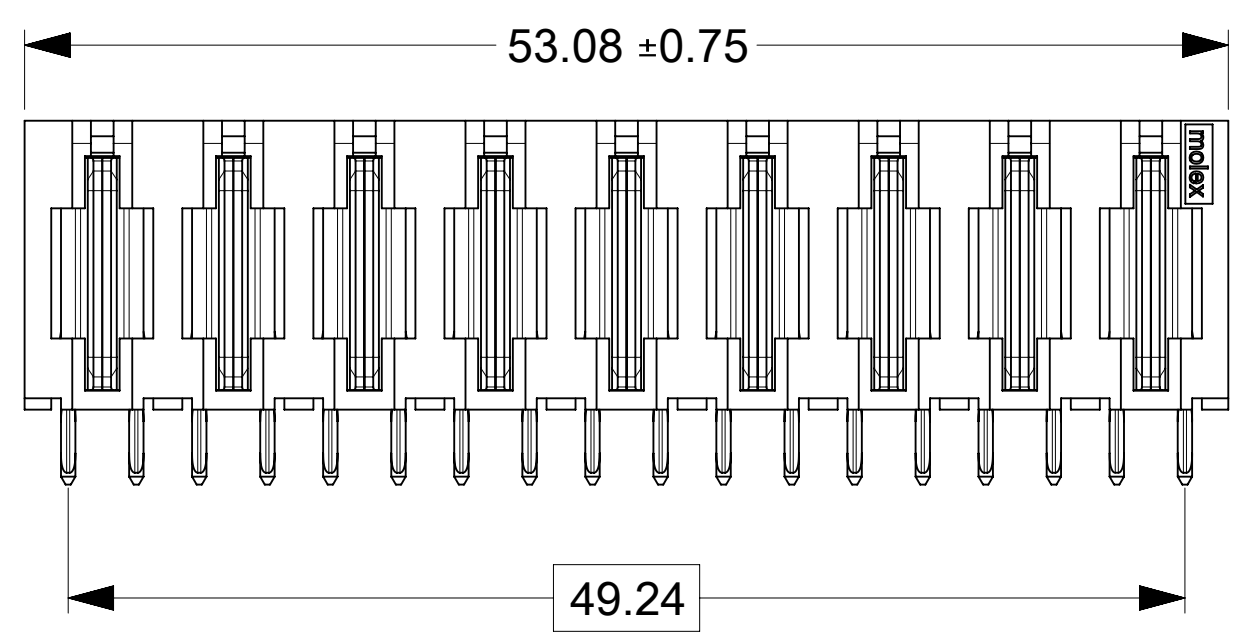

PART NUMBER	CONFIGURATION	QUANTITY PER CARTON (DU)
219562-0040	10P	64

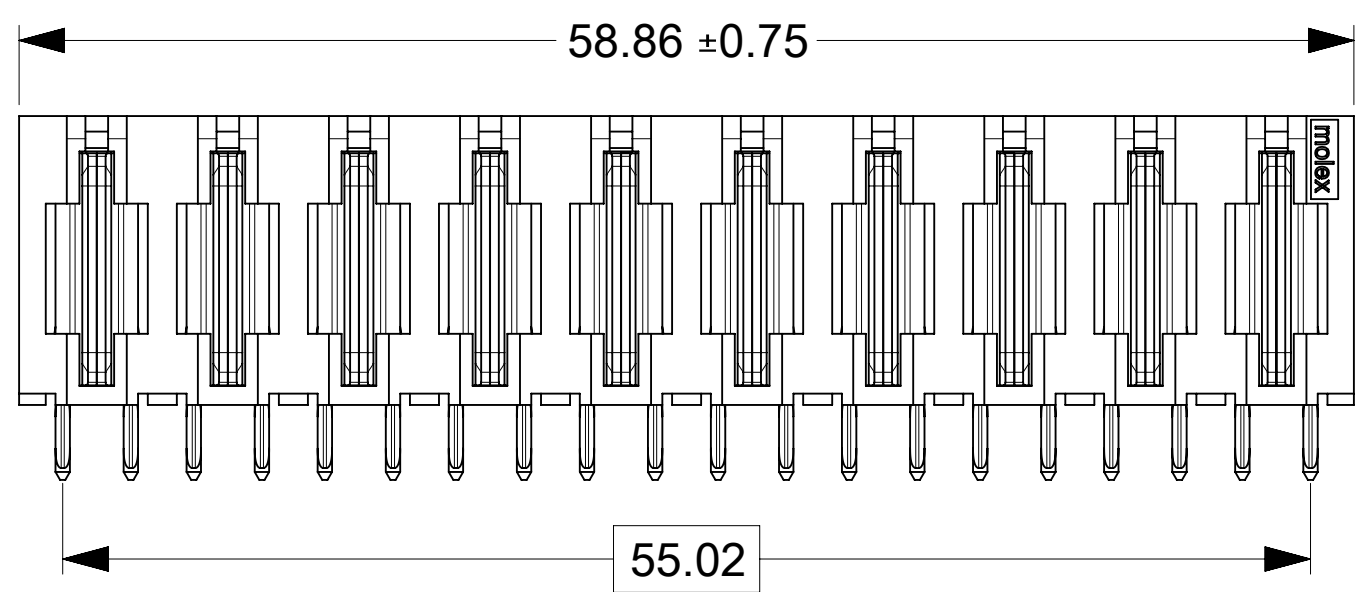

THIS DRAWING CONTAINS INFORMATION THAT IS PROPRIETARY TO MOLEX ELECTRONIC TECHNOLOGIES, LLC AND SHOULD NOT BE USED WITHOUT WRITTEN PERMISSION

DIMENSION UNITS	SCALE	CURRENT REV DESC:	
mm	3:1		
GENERAL TOLERANCES (UNLESS SPECIFIED)			
ANGULAR TOL	±	°	
4 PLACES	±		
3 PLACES	±		
2 PLACES	±	0.25	
1 PLACE	±	0.3	
0 PLACES	±		
DRAFT WHERE APPLICABLE MUST REMAIN WITHIN DIMENSIONS		THIRD ANGLE PROJECTION	DRAWING
		D-SIZE	SERIES
		219562	219562
		MATERIAL NUMBER	CUSTOMER
		SEE CHART	
		SHEET NUMBER	2 OF 2

molex

GUARDIAN HD RA PLUG POWER ONLY
UNGUIDED PF

PRODUCT CUSTOMER DRAWING

DOCUMENT NUMBER	DOC TYPE	DOC PART	REVISION
2195629003-SD	PSD	000	A1

DOCUMENT STATUS	P1	RELEASE DATE	2023/04/11	17:04:40
-----------------	----	--------------	------------	----------