

PRO-50A

Handheld Digital Multimeter



Safety Summary

A **WARNING** statement calls attention to an operating procedure, practice, or condition, which, if not followed correctly, could result in injury or death to personnel.

A **CAUTION** statement calls attention to an operating procedure, practice, or condition, which, if not followed correctly, could result in damage to or destruction of parts or the entire product.

To avoid possible electric shock or personal injury, follow these guidelines:

- Use the meter only as specified in this manual or the protection provided by the meter might be impaired.
- Do not use the meter or test leads if they appear damaged, or if the meter is not operating properly.
- Always use proper terminals, switch position, and range for measurements.
- Test the meter's operation on a known voltage before using it in general. If in doubt, have the meter serviced.
- Do not apply more than the rated voltage, as marked on the meter, between terminals or between any terminal and earth ground.
- Disconnect circuit power and discharge all high-voltage capacitors before testing resistance, continuity, diodes, or capacitances.
- Do not use the meter around explosive gas or vapor.
- When using test leads or probes, keep your fingers behind the finger guards.
- Only use test leads and accessories that have the same voltage, category, and amperage ratings as the meter and that have been approved by a safety agency.
- Disconnect the test leads from the meter before removing the battery cover or meter case.
- Comply with local and national safety requirements when working in hazardous locations.
- Use proper protective equipment, as required by local or national authorities, when working in hazardous areas.
- Avoid working alone.

- Check the test leads for continuity before use. Do not use if the readings are high or noisy.
- Do not install substitute parts or perform any unauthorized modifications to this instrument. Return the instrument to Cal Test Electronics for service and repair to ensure that safety features are maintained.
- If the meter is used near noise generating equipment, be aware that the display may become unstable or indicate large errors.
- Never ground yourself when taking electrical measurements
- Using this meter in an environment with a strong radiated radio-frequency electromagnetic field (approx. 3 V/m), may negatively affect the measuring accuracy.

Compliance Statements

Disposal of Old Electrical & Electronic Equipment

(Applicable in the European Union and other European countries with separate collection systems). This product is subject to

Directive 2012/19/EU of the European Parliament and the Council of the European Union on waste electrical and electronic equipment (WEEE), and in jurisdictions adopting that Directive, is marked as being put on the market after August 13, 2005, and should not be disposed of as unsorted municipal waste. Please utilize your local WEEE collection facilities in the disposition of this product

and otherwise observe all applicable requirements.



The PRO-50A is CE compliant

CE Declaration of Conformity

The power supply meets the requirements of 2006/95/EC Low Voltage Directive and 2004/108/EC Electromagnetic Compatibility Directive with the following standards.

- Low Voltage Directive: EN61010-1. Safety requirements for electrical equipment for measurement, control, and laboratory use-Part 1: General requirements
- EMC Directive: EN 61326-1:2006

Operating Environment

This meter meets IEC 61010-1 2nd Edition standards which define four measurement categories:

CAT I	Measurement instruments whose measurement inputs are not intended to be connected to the mains supply. The voltages in the environment are typically derived from a limited-energy transformer or a battery.
CAT II	Measurement instruments whose measurement inputs are meant to be connected to the mains supply at a standard wall outlet or similar sources.
CAT III	Measurement instruments whose measurement inputs are meant to be connected to the mains installation of a building.
CAT IV	Measurement instruments whose measurement inputs are meant to be connected to the source of power for a given building.

The instrument may be operated in the following environment:

Measurement Category	CAT III, 1000 V CAT IV, 600 V
Operating Environment	0 °C to 40°C
Storage Humidity	0 – 85% R.H.
Storage Environment	-20 °C to +70°C
Pollution Degree	Pollution Degree 2

1	General Information	5
1.	Product Overview.....	5
2.	Features.....	5
2	Package Contents.....	5
3	Product Description.....	6
1.	Front Panel.....	6
2.	Display Diagram.....	7
4	Using the Digital Multimeter	8
1.	DC and AC Voltage Measurements.....	8
2.	DC and AC Current Measurements.....	9
3.	Resistance Measurements.....	11
4.	Diode Measurements.....	12
5.	Continuity Test.....	13
6.	Capacitance Measurements.....	14
7.	Transistor Gain Measurements	15
8.	Temperature Measurements.....	15
9.	Frequency Measurements	16
10.	Auto Power-Off.....	16
11.	Data Hold Mode.....	17
12.	Non-Contact AC Voltage Detection	17
5	Specifications	17
1.	General Specifications	17
2.	Measurement Specifications.....	18
6	Maintenance.....	21
1.	Cleaning.....	21
2.	Battery and Fuse Replacement.....	21
3.	Warranty	22
4.	Calibration and Repair	22

1 General Information

1. Product Overview

The Global Specialties PRO-50A Handheld Digital Multimeter provides standard measurement functions, which include AC and DC voltage, AC and DC current, resistance, capacitance, diode, and continuity.

2. Features

- 3½ Digit display resolution
- DC Voltage measurement up to 1000 V
- AC Voltage measurement up to 750 V
- AC and DC Current up to 10 A
- Frequency measurements
- Temperature measurements

2 Package Contents

Please inspect the instrument mechanically and electrically upon receiving it. Unpack all items from the shipping carton, and check for any obvious signs of physical damage that may have occurred during transportation. Report any damage to the shipping agent immediately. Save the original packing carton for possible future reshipment. The package includes the following:

- PRO-50A handheld digital multimeter
- 1x User manual
- 1x Test leads
- 1x “K” type bead thermocouple
- 1x Special multi-function socket

3 Product Description

1. Front Panel

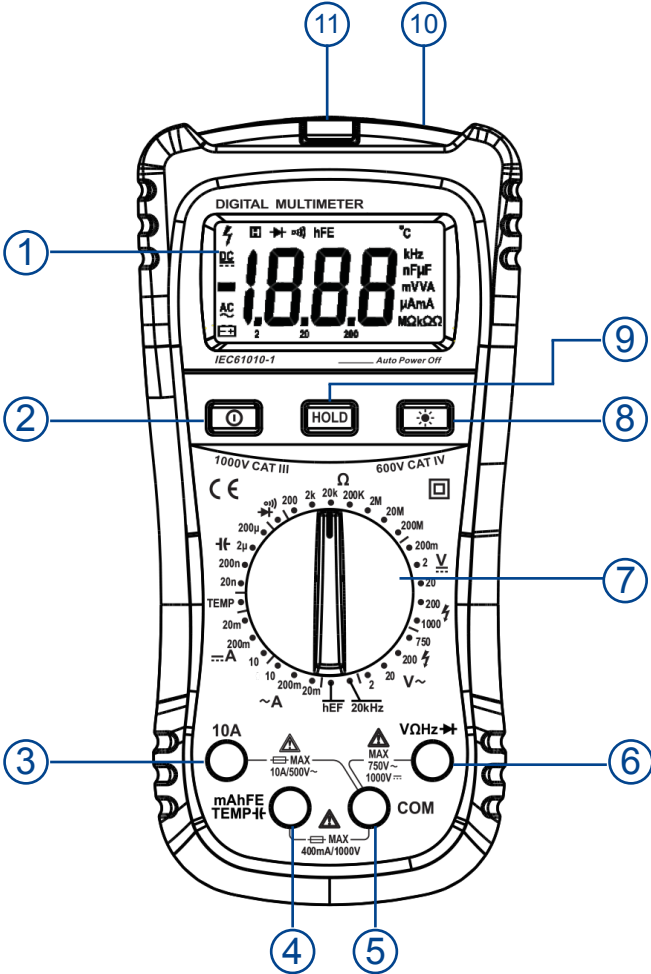

Figure 1. Front Panel Diagram

Front Panel Description

1. Display: Displays the measured values, selected function mode, and annunciators.
2. Power Button: Turns the meter on or off.
3. 10 A: The positive input terminal for up to 10 A current measurement.
4. mAhFE, TEMP: The positive input terminal for up to 400 mA, as well as for capacitive and temperature measurements.
5. COM: The negative (ground) input terminal for all measurement modes. Connection is made to it using the black test lead.
6. VΩHz: The positive input terminal for voltage, ohms, frequency and diode measurements. Connection is made using the red test lead.
7. Function/Range Rotary Switch: Selects the function and desired range.
8. Backlight: Press to activate LCD backlight.
9. HOLD: Displays the current value on the display even if the leads are removed from device under test. Pressing the button again returns to current reading measurement mode.
10. AC Voltage Sensor: Sensor for non-contact AC voltage detection.
11. AC Voltage Indicator: Indicator LED for AC voltage ≥ 110 Vrms.

2. Display Diagram

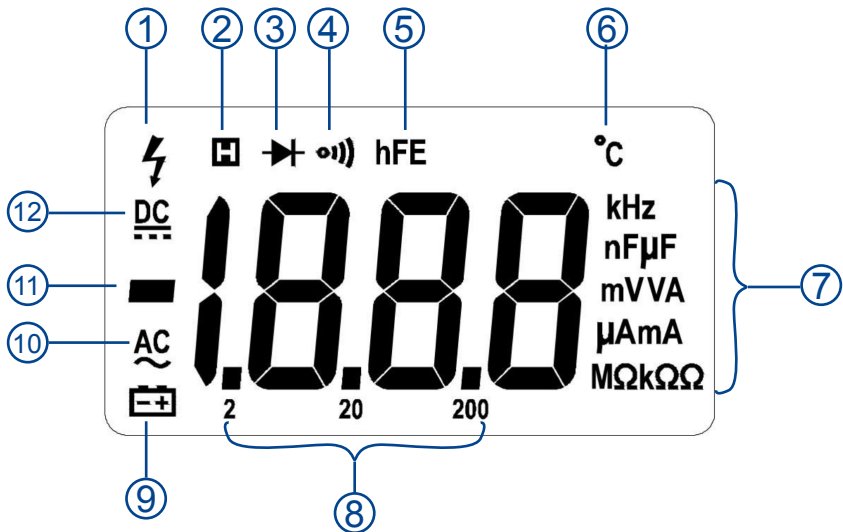

Figure 2. Display Diagram

Display Description

1. Indicates use of the highest voltage settings
2. The meter is in data hold mode
3. The meter is in diode test mode
4. The meter is in continuity check mode
5. The meter is in transistor gain mode
6. The meter is in temperature mode
7. Units of measure
8. Indicates range
9. Low battery indicator. WARNING . To avoid false readings which could lead to electric shock or instrument damage, change the battery as soon as this indicator appears.
10. Alternating current
11. Indicates negative value
12. Direct current

4 Using the Digital Multimeter

With no signal present, set the rotary switch to the desired measurement function. Ensure proper insertion of the test leads so they correspond with the type of measurement you wish to perform. When connecting the test leads to the circuit or device, connect the COM test lead (black) before connecting the live lead (red). When removing the test leads, remove the live lead first.

WARNING

To avoid electric shock, injury, or damage to the meter, disconnect circuit power and discharge all high-voltage capacitors before testing resistance, continuity, diodes, or capacitance.

CAUTION:

Always connect the test leads to the meter's inputs first before connecting the DUT to avoid potential shock hazard.

1. DC and AC Voltage Measurements

The meter's DC voltage ranges, \underline{V} , are 200 mV, 2 V, 20 V, 200 V, and 1000 V. The AC voltages ranges, $\underline{V}\sim$, are 2 V, 20 V, 200 V, and 750 V. Turn the rotary switch to the corresponding symbol for the

measurement you would like to perform.

Follow these steps to make a measurement:

1. Connect the negative (-) side with the black test lead to the COM input.
2. Connect the positive (+) side with the red test lead to the VΩHz⎓ input.
3. Probe with the test leads to the DUT and record the measured reading on the display.

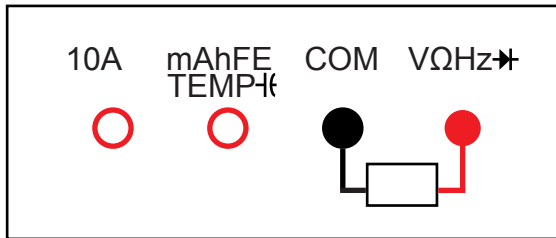

Figure 3. Connection for AC or DC Voltage Measurement

2. DC and AC Current Measurements

WARNING

To avoid personal injury or damage to the meter:

- Never attempt to make in-circuit current measurement when the open-circuit potential to earth is >600 V.
- Check the meter's fuse before testing.
- Use the proper terminals, switch position, and range for your measurement.
- Never place the probes in parallel with a circuit or component when the leads are plugged into the current terminals.

The meter's DC current ranges, ---A , are 20 mA, 200 mA, and 10 A. The meter's AC current ranges, ~A , are 20 mA, 200 mA, and 10 A. Turn the rotary switch to the corresponding symbol for the measurement you would like to perform.

Follow these steps to make a measurement:

1. Connect the black test lead to the COM terminal and the red test lead to the mA terminal for a maximum of 200 mA. For a maximum of 10 A, move the red test lead to the 10 A terminal.
2. Turn circuit power off.
3. Break the circuit path to be tested. Connect the black test lead to the more negative side of the break; connect the red test lead to the more positive side of the break. (Reversing leads will give a negative reading, but will not damage the meter.)
4. Turn on the power of the measured circuit and read the display. Be sure to note the measurement units at the right side of the display (mA or A). When only the figure “1” is displayed, it indicates an overrange situation and the higher range has to be selected.
5. Turn off the power of the measured circuit and discharge any high voltage capacitors. Remove the test leads and reconnect the test circuit.

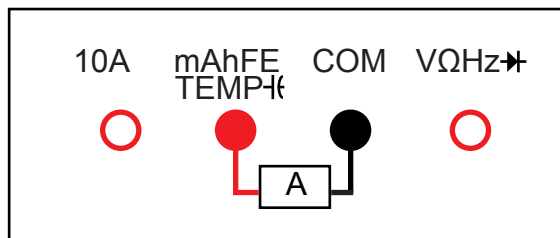

Figure 4. Connection for Low AC or DC Current Measurement

WARNING

Do not connect more than 400 mA DC current across the mA input terminal or the protection fuse will be tripped.

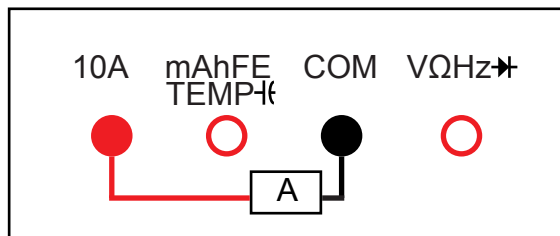

Figure 5. Connection for Higher AC or DC Current Measurement

WARNING

Do not connect more than 10 A DC current across the 10 A input terminal or the protection fuse will be tripped.

3. Resistance Measurements

The meter's resistance ranges, Ω , are 200 Ω , 2 k Ω , 20 k Ω , 200 k Ω , 2 M Ω , 20 M Ω , 200 M Ω . Turn the rotary switch to the proper range.

Follow these steps to make a measurement:

1. Connect the black test lead to the COM input. Note that the measurement voltage polarity is positive on COM input.
2. Connect the red test lead to the V Ω H \rightarrow input.
3. Probe with the test leads to the DUT and record the measured reading on display.

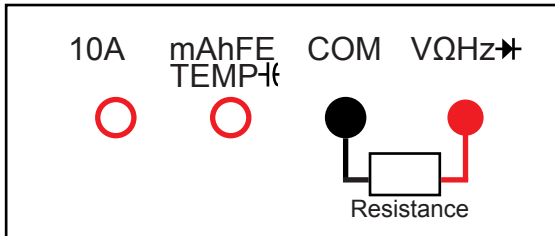

Figure 6. Connection for Resistance Measurement

WARNING

Do not apply more than 1000 V DC across the terminals or they will be damaged.

Tips for resistance measuring:

- The measured value of a resistor in a circuit is often different from the resistor's rated value. This is because the meter's test current flows through all possible paths between the probe tips.
- In order to ensure the best accuracy in measurement of low resistance, short the test leads before measurement and note

the resistance. This value represents the resistance of the test leads and should be subtracted.

- On 20 M Ω and 200 M Ω ranges, the meter may take a few seconds to stabilize the reading. This is normal for high resistance measuring.
- When the input is not connected, i.e. at open circuit, the figure “1” will be displayed indicating an overrange condition.

4. Diode Measurements

Use the diode test to check diodes and other semiconductor devices. The diode test sends a current through the semiconductor junction, and then measures the voltage drop across the junction. A good silicon junction drops between 0.5 V and 0.8 V.

CAUTION

Always connect the test leads to the instrument inputs first before connecting the DUT to avoid potential shock hazard.

Follow these steps to make conduct a diode test:

1. Set the rotary switch to the diode range, \blacktriangleright .
2. Connect the black test lead to the COM input.
3. Connect the red test lead to the V Ω Hz \blacktriangleright input.
4. For forward-bias readings on any semiconductor component, place the red test lead on the component's anode and place the black test lead on the component's cathode.
5. The meter will show the approximate forward voltage of the diode. If the test lead connection is reversed, only the figure “1” will be displayed.
6. In a circuit, a good diode should still produce a forward bias reading of 0.5 V to 0.8 V; however, the reverse-bias reading can vary depending on the resistance of other pathways between the probe tips.

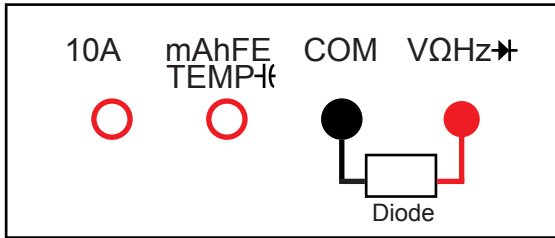



Figure 7. Connection for Diode Measurement

WARNING

Do not apply more than 1000 V DC across the terminals or they will be damaged.

5. Continuity Test

Continuity is a complete path for current flow. The meter's continuity test is available to check for open/shorts of the circuit. The beeper sounds if a circuit is complete. To test for continuity:

1. Set the rotary switch to the continuity range, .
2. Connect the black test lead to the COM input.
3. Connect the red test lead to the VΩHz input.
4. Connect the test leads to the resistance in the circuit being measured.
5. When the test lead to the circuit is below 30 Ω, a continuous beep will sound, thus indicating a closed circuit.

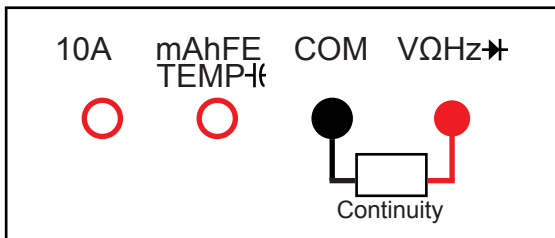

Figure 8. Connection for Continuity Test

WARNING

Do not apply more than 1000 V DC across the terminals or they will be damaged.

6. Capacitance Measurements

Capacitance is the ability of a component to store an electrical charge. The unit of capacitance is the farad (F). Most capacitors are in the nanofarad to microfarad range.

The meter's capacitance ranges, f , are 20 nF, 200 nF, 2 μ F, and 200 μ F. Turn the rotary switch the corresponding symbol for the measurement you would like to perform.

WARNING

To avoid electrical shock and/or damage to the instrument, disconnect circuit power and discharge all high-voltage capacitors before measuring capacitance. Use the DC voltage function to confirm that the capacitor is discharged.

CAUTION

Always connect the test leads to the instrument inputs first before connecting the DUT to avoid potential shock hazard.

Follow these steps to make a capacitance measurement:

1. Connect the black test lead to the COM input. This will connect to the negative side of your capacitor.
2. Connect the red test lead to the f input. This will connect to the positive side of your capacitor.
3. Probe with the test leads to the DUT and take the measured reading on display.
4. The meter may take a few seconds to stabilize the reading. This is normal for high capacitance measuring.
5. To improve the accuracy of measurements less than 20 nF, subtract the residual capacitance of the meter and leads.

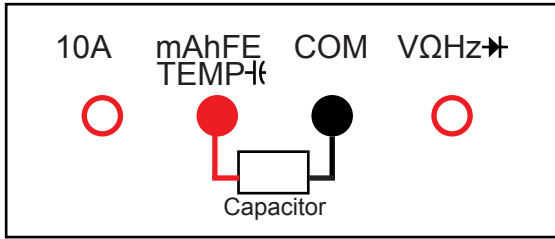

Figure 9. Connection for Capacitance Measurements

WARNING

Do not apply more than 1000 V DC across the terminals or they will be damaged.

7. Transistor Gain Measurements

WARNING

To avoid electrical shock and/or damage to the instrument, do not apply more than 250 VDC or 250 ACrms between the hFE terminal and the COM terminal.

Using the included multi-function socket, DC transistor gain (hFE) can be measured. Follow these steps to make hFE measurements:

1. Set the rotary switch to hFE range.
2. Connect the “COM” plug and “+” plug of the special multi-function socket to the COM and hFE terminals, respectively, on the meter.
3. Determine whether the transistor to be tested is NPN or PNP type and locate the emitter, base, and collector leads.
4. Insert leads of the transistor into the proper holes of the special multi-function socket: “c” for collector, “b” for base, and “e” for emitter.
5. The meter will show the approximate hFE value for the test condition of base current 10 μ A DC and V_{ce} 2.8 VDC.

8. Temperature Measurements

WARNING

To avoid electrical shock, do not use this instrument when voltages at the measurement surface exceed 60 VDC or 24 VACrms.

Follow these steps to make a temperature measurement.

1. Set the rotary switch to the **TEMP** range. The LCD will show the current environmental temperature.
2. Connect the “COM” plug and “+” plug of the special multi-function socket to the COM and TEMP terminals.
3. Insert the “K” type thermocouples into the multi-function socket. Take care to observe the correct polarity.
4. Touch the object under test with the thermocouple probe for measurement.
5. Take measured reading (in °C) from the display.

9. Frequency Measurements

WARNING

To avoid electrical shock hazard and/or damage to the instrument, do not measure frequency on high voltage (>250 V).

Follow these steps to make a frequency measurement.

1. Turn the rotary switch to the frequency range, **20kHz**.
2. Connect the black test lead to the COM input.
3. Connect the red test lead to the VΩHz✶.
4. Connect the test leads to the circuit being measured.
5. Read the displayed value.

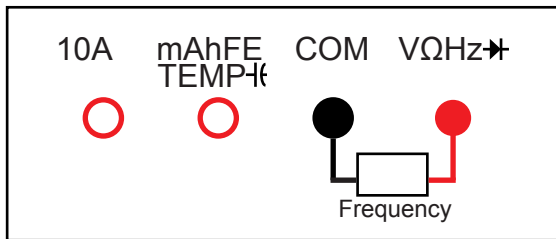



Figure 10. Connection for Frequency Measurement

10. Auto Power-Off

Auto power off occurs approximately after 15 minutes when there has been no interaction with the meters knobs or buttons.

11. Data Hold Mode

Data HOLD mode makes the meter stop updating the display. The data HOLD function can be canceled by changing the measurement mode, or by pushing the HOLD key again. To enter and exit the data HOLD mode:

6. Press HOLD key. This fixes the display on the current value.  is displayed.
7. A second short press returns the meter to normal mode.

12. Non-Contact AC Voltage Detection

Hold the meter so that the meter's top is vertically and horizontally centered and contacting the conductor. Where there is AC voltage >100 VACrms the LED indicator will light up.

WARNING

Even even there is no indication, voltage may still exist. Do not rely on the non-contact voltage detector with shielded wire. Detection operation may be subject to socket design, insulation thickness and type.

5 Specifications

1. General Specifications

- Display: 3½ digit LCD with automatic indication of functions and symbols
- Polarity: Automatic, (-) negative polarity indication
- Overrange Indication: LCD with display "1"
- Low Battery Indication: Indicates current capacity of battery.
- When the battery is low,  will show in the display.
- Sample Rate: 3 times/second for digital data
- Operating Environment: 0°C to 40°C at < 80% R.H, < 10°C noncondensing
- Storage Environment: -10°C to 60°C at < 70% R.H (battery removed)
- Temperature Coefficient: 0.1×(specified accuracy)/°C. (<18°C or >28°C)
- Altitude: <6561.7 ft (2000 m)

- Power: Single 9 V battery
- Dimensions (H × W × D): 188 x 92 x 50 mm
- Weight: Approx. 380 grams (including battery)

2. Measurement Specifications

Accuracy is specified for one year after calibration, at operating temperatures of 18°C to 28°C, with relative humidity at 0% to 75%. Accuracy specifications take the form of: $\pm(\% \text{ of Reading} + \text{Number of Least Significant Digits})$.

a. DC Voltage

Range	Resolution	Accuracy
200 mV	0.1 mV	$\pm(0.5\% \text{ of rdg} + 1 \text{ digit})$
2 V	1 mV	
20 V	10 mV	
200 V	100 mV	
1000 V	1 V	$\pm(0.8\% \text{ of rdg} + 2 \text{ digit})$

Input Impedance: 10 M Ω

Max Input Voltage: 250 VDC or ACrms for 200 mV range and 1000 VDC or 750 ACrms for other ranges.

b. AC Voltage

Range	Resolution	Accuracy
2 V	1 mV	$\pm(0.8\% \text{ of rdg} + 3 \text{ digits})$
20 V	10 mV	
200 V	100 mV	
750 V	1 V	$\pm(1.2\% \text{ of rdg} + 3 \text{ digits})$

Input Impedance: 10 M Ω

Max Input Voltage: 250 VDC or ACrms for 200 mV range and 1000 VDC or 750 ACrms for other ranges.

Frequency Range: 40 Hz-400 Hz

Response: Average, calibrated in rms of sine wave

c. DC Current

Range	Resolution	Accuracy
20 mA	10 μ A	$\pm(0.8\% \text{ of rdg} + 1 \text{ digit})$
200 mA	0.1 mA	$\pm(1.5\% \text{ of rdg} + 1 \text{ digit})$
10 A	10 mA	$\pm(2.0\% \text{ of rdg} + 5 \text{ digits})$

Overload Protection: Fuse (FF400mA/1000V) and 10 A range fuse (FF10A/500V)

Max Input Current: 200 mA DC or 200 mA ACrms for mA range
 10A DC or 10 A ACrms for 10 A range
 For measurements >5 A, 10 seconds maximum ON to measure, 1 minute OFF. Above 10 A unspecified.

d. AC Current

Range	Resolution	Accuracy
20 mA	10 μ A	$\pm(1.0\%$ of rdg +3 digits)
200 mA	0.1 mA	$\pm(1.8\%$ of rdg +3 digits)
10 A	10 mA	$\pm(3.0\%$ of rdg +7 digits)

Overload Protection: Resettable fuse (FF400mA/1000V) and 10 A range fuse (FF10A/500V)
 Max Input Current: 200 mA DC or 200 mA ACrms for mA range
 10A DC or 10 A ACrms for 10 A range
 For measurements >5 A, 10 seconds maximum ON to measure, 1 minute OFF. Above 10 A unspecified.
 Response: Average, calibrated in rms of sine wave.

e. Resistance

Range	Resolution	Accuracy
200 Ω	0.1 Ω	$\pm(0.8\%$ of rdg + 3 digits)
2 k Ω	1 Ω	$\pm(0.8\%$ of rdg + 1 digit)
20 k Ω	10 Ω	
200 k Ω	100 Ω	
2 M Ω	1 k Ω	
20 M Ω	10 k Ω	$\pm(1.0\%$ of rdg + 2 digits)
200 M Ω	0.1 M Ω	$\pm(5.0\%$ of rdg + 10 digits)

Overload protection: 250 VDC or 250 VACrms
 Open Circuit Voltage: <700 mV

f. Continuity Test

Audible Threshold
$\leq 30 \Omega$

Test Current: Approx. 1 mA
 Reversed DC Voltage: Approx. 2.8 V
 Overload Protection: 250 VDC or 250 VACrms

g. Diode Test

Range	Forward DC Current	Reversed DC Voltage
1 mV	1 mA	2.8 V typical

Overload Protection: 250 VDC or 250 VACrms

h. Capacitance

Range	Resolution	Accuracy
20 nF	10 pF	±(4.0% of rdg +3 digits)
200 nF	0.1 nF	
2 µF	1 nF	
200 µF	100 nF	±(5.0% of rdg +10 digits)

Overload Protection: Fuse (FF400mA/1000V).

i. Temperature

Range	Resolution	Accuracy
-20°C to 0°C	1°C	±(5.0% of rdg +4 digits)
1°C to 400°C		±(2.0% of rdg +3 digits)
401°C to 1000°C		±(2.0% of rdg +5 digits)

Overload Protection: Fuse (FF 400mA/1000V).

Temperature specifications do not include thermocouple errors.

j. Frequency

Range	Resolution	Accuracy
20 kHz	10 Hz	±(1.5% of rdg + 5 digits)

Overload Protection: 250 VDC or 250 VACrms

Input Voltage Range: 200 mV to 10 VACrms

k. Transistor

Function	Description	Test Condition
hFE	Display reads approx. hFE value (0-1000) of transistor under test (all types).	Base current approx. 10 µA, Vce approx. 2.8 V

6 Maintenance

1. Cleaning

If the instrument requires cleaning, disconnect it from all power sources and clean only with a mild detergent and water. Be sure the instrument is completely dry before reconnecting it to any power source. To clean the exterior surface:

1. Remove loose dust on the outside of the instrument and probes with a lint-free cloth.
2. Use a soft cloth dampened with water to clean the instrument.
3. To avoid damaging the surface of the instrument and probes, do not use any chemically abrasive cleaning agents.

2. Battery and Fuse Replacement

WARNING

To avoid electrical shock, disconnect the test leads and any input signals before replacing the battery. Replace only with same type of battery.

1. Disconnect test leads from any live source, turn the rotary switch to OFF, and remove the test leads from the input terminals.
2. The battery case is secured to the main case by 1 screw. Using a Phillips-head screwdriver, remove the screw from the battery case and remove the battery case.
3. Remove battery and replace with a new equivalent 9-volt battery.
4. Fuse: F1 / 400mA / 1000V fast blow ceramic fuse (6 x 32 mm size)
5. Fuse: F2 / 10A / 500V fast blow ceramic fuse (6 x 32 mm size)
6. Replace the bottom case and reinstall the screws.

Service and Warranty Information

3. Warranty

Cal Test Electronics warrants this product to be free from defective material or workmanship for a period of 1 year from the date of original purchase. Under this warranty, Cal Test Electronics is limited to repairing the defective device when returned to the factory, shipping charges prepaid, within the warranty period.

Units returned to Cal Test Electronics that have been subject to abuse, misuse, damage or accident, or have been connected, installed or adjusted contrary to the instructions furnished by Cal Test Electronics, or that have been repaired by unauthorized persons, will not be covered by this warranty.

Cal Test Electronics reserves the right to discontinue models, change specifications, price, or design of this device at any time without notice and without incurring any obligation whatsoever.

The purchaser agrees to assume all liabilities for any damages and/or bodily injury which may result from the use or misuse of this device by the purchaser, his employees, or agents.

This warranty is in lieu of all other representations or warranties expressed or implied and no agent or representative of Cal Test Electronics is authorized to assume any other obligation in connection with the sale and purchase of this device.

4. Calibration and Repair

If you have a need for any calibration or repair services, please visit us on the web at: globalspecialties.com. See the "Service" tab. Or contact us via the "Contact" tab. You may also contact us at:

Cal Test Electronics, Inc.
(parent company of Global Specialties®)
22820 Savi Ranch Parkway
Yorba Linda, CA 92887
800-572-1028 or 714-221-9330



20160203

