



# EVK-R4

## SARA-R4 series cellular evaluation kits

### User guide



#### **Abstract**

This guide explains how to set up the EVK-R4 evaluation kits to begin evaluating the u-blox SARA-R4 series cellular modules supporting multi-band LTE Cat M1 / NB1 radio access technology.

# Document information

<b>Title</b>	<b>EVK-R4</b>	
<b>Subtitle</b>	SARA-R4 series cellular evaluation kits	
<b>Document type</b>	User guide	
<b>Document number</b>	UBX-16029216	
<b>Revision and date</b>	R06	23-Feb-2021
<b>Disclosure restriction</b>	C1-Public	

<b>Product status</b>	<b>Corresponding content status</b>	
<b>Functional sample</b>	Draft	For functional testing. Revised and supplementary data will be published later.
<b>In development / Prototype</b>	Objective specification	Target values. Revised and supplementary data will be published later.
<b>Engineering sample</b>	Advance information	Data based on early testing. Revised and supplementary data will be published later.
<b>Initial production</b>	Early production information	Data from product verification. Revised and supplementary data may be published later.
<b>Mass production / End of life</b>	Production information	Document contains the final product specification.

This document applies to the following products:

<b>Product name</b>	<b>Type number</b>	<b>Modem version</b>	<b>Application version</b>	<b>PCN reference</b>	<b>Product status</b>
EVK-R404M	EVK-R404M-00B-00	K0.0.00.00.07.08		UBX-18055331	Obsolete
EVK-R410M	EVK-R410M-01B-00	L0.0.00.00.02.03		UBX-18059854	Obsolete
	EVK-R410M-02B-00	L0.0.00.00.05.12	A.02.19	UBX-20058104	Initial production
	EVK-R410M-52B-00	L0.0.00.00.06.08	A02.11	UBX-20033274	Obsolete
	EVK-R410M-6-00	L0.08.12	A.01.12	UBX-20053055	Initial production
	EVK-R410M-7-00	L0.08.12	A.01.12	UBX-20049254	Initial production
	EVK-R410M-8-00	L0.08.12	A.01.12	UBX-20049255	Initial production
EVK-R412M	EVK-R412M-02B-00	M0.12.00	A.02.19	UBX-20058105	Initial production

u-blox or third parties may hold intellectual property rights in the products, names, logos and designs included in this document. Copying, reproduction, modification or disclosure to third parties of this document or any part thereof is only permitted with the express written permission of u-blox.

The information contained herein is provided "as is" and u-blox assumes no liability for its use. No warranty, either express or implied, is given, including but not limited to, with respect to the accuracy, correctness, reliability and fitness for a particular purpose of the information. This document may be revised by u-blox at any time without notice. For the most recent documents, visit [www.u-blox.com](http://www.u-blox.com).

Copyright © u-blox AG.

# Contents

Document information.....	2
Contents .....	3
1 Starting up.....	4
Appendix .....	16
A Setting up AT terminal applications for communication with the EVK-R4.....	16
B Setting up a cellular packet data connection on a Windows PC.....	17
C Examples of AT commands .....	22
D Current consumption measurement.....	24
E Glossary .....	25
Declaration of conformities.....	26
Related documentation .....	27
Revision history .....	27
Contact.....	28

# 1 Starting up

## 1.1 EVK-R4 overview

The EVK-R4 kit is a powerful and easy-to-use tool that simplifies the evaluation of the u-blox SARA-R4 series LTE Cat M1 / NB1 cellular modules.

The following evaluation kits are available with u-blox SARA-R4 cellular modules:

- The EVK-R404M evaluation kit is for evaluation of SARA-R404M modules
- The EVK-R410M evaluation kit is for evaluation of SARA-R410M modules, and more specifically:
  - The EVK-R410M-01B evaluation kit is for the SARA-R410M-01B module product version
  - The EVK-R410M-02B evaluation kit is for the SARA-R410M-02B module product version
  - The EVK-R410M-52B evaluation kit is for the SARA-R410M-52B module product version
  - The EVK-R410M-6 evaluation kit is for the SARA-R410M-63B module product version
  - The EVK-R410M-7 evaluation kit is for the SARA-R410M-73B module product version
  - The EVK-R410M-8 evaluation kit is for the SARA-R410M-83B module product version
- The EVK-R412M evaluation kit is for evaluation of SARA-R412M modules

All the evaluation kits are identified herein as the EVK-R4.

 See the SARA-R4 series data sheet [\[2\]](#) and the SARA-R4 series system integration manual [\[3\]](#) for the features supported by the u-blox SARA-R4 series cellular modules.

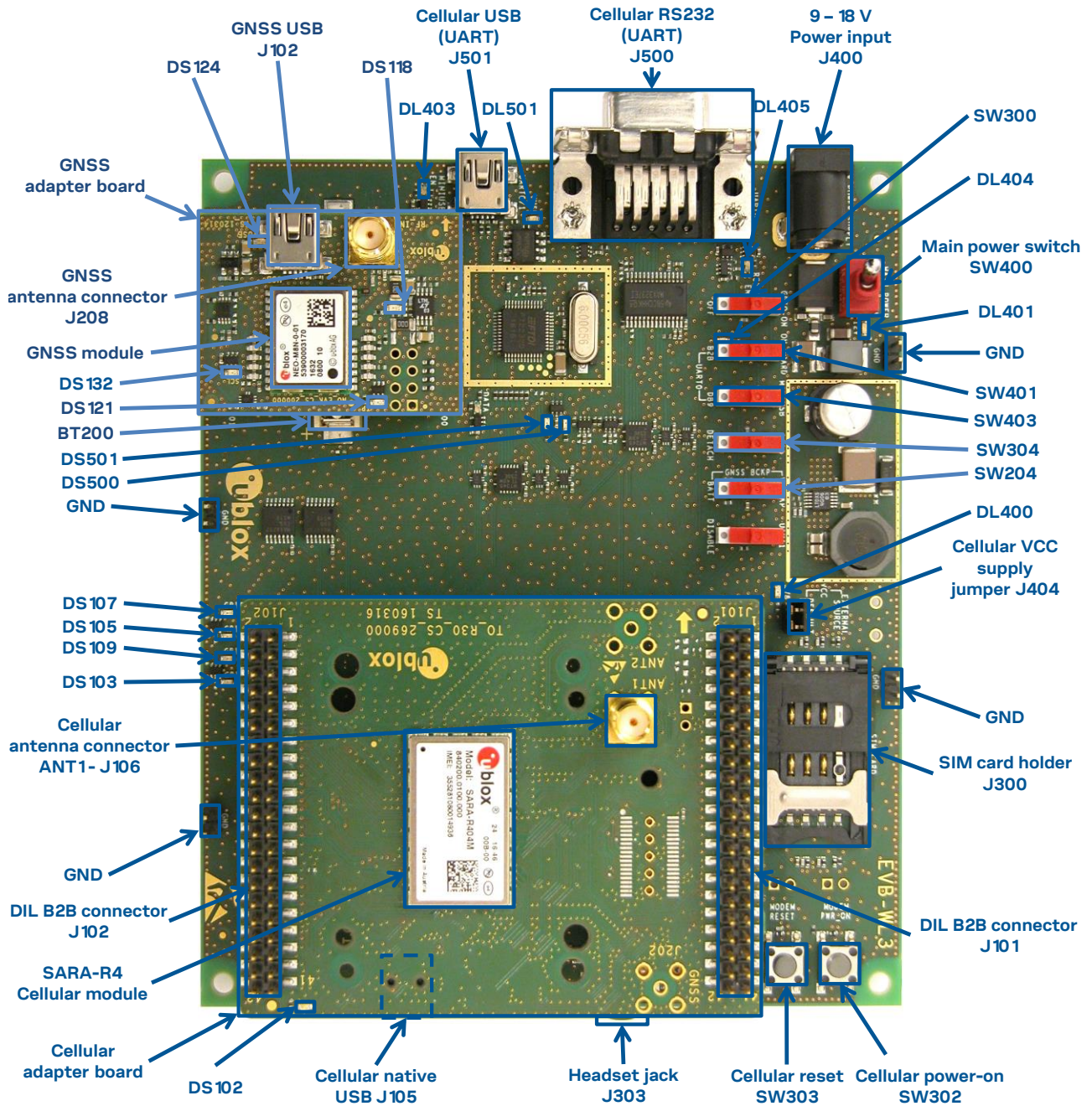

Figure 1: Overview of the EVK-R404M evaluation kit for SARA-R404M modules

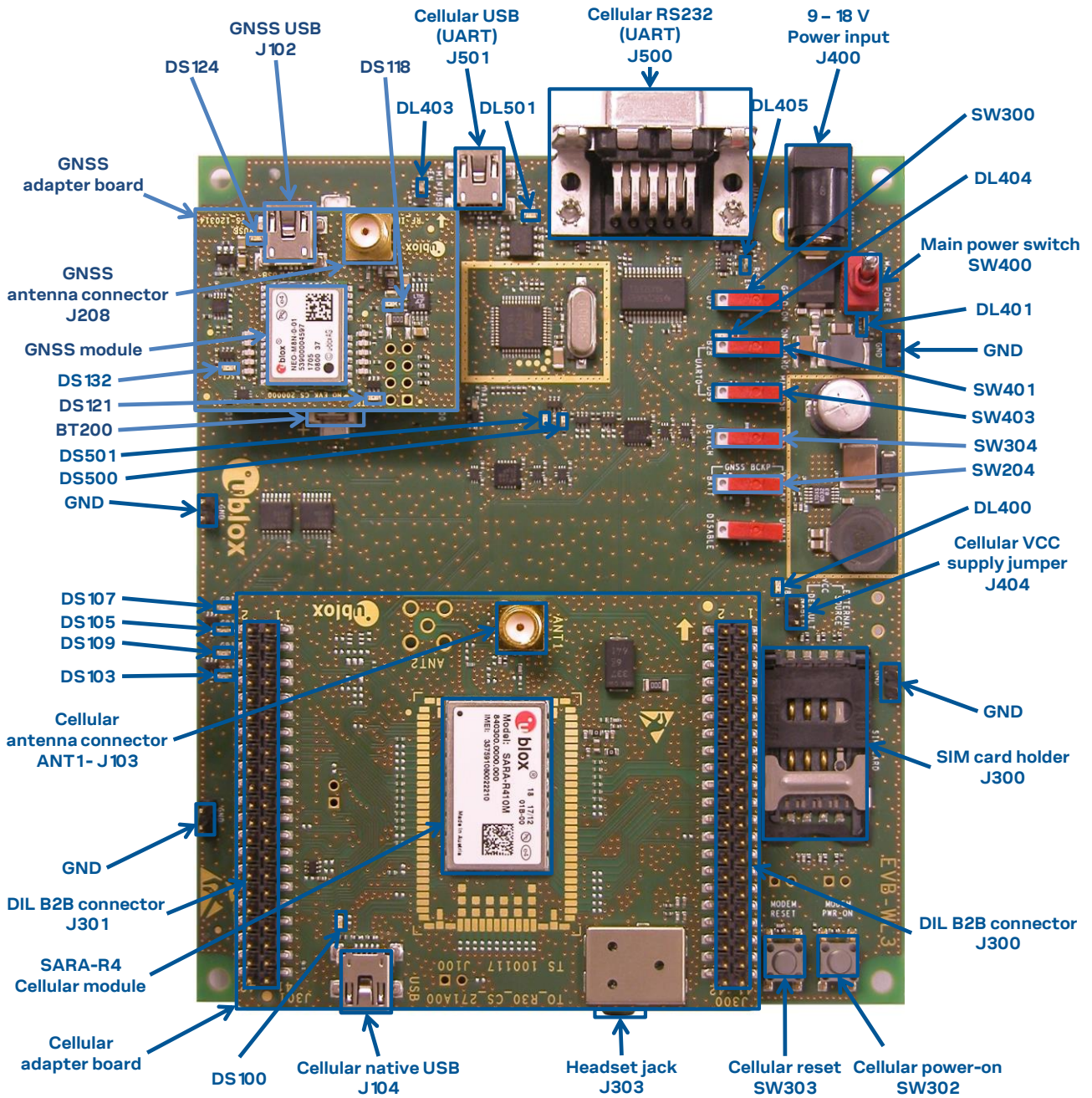

Figure 2: Overview of the EVK-R410M evaluation kit for SARA-R410M modules

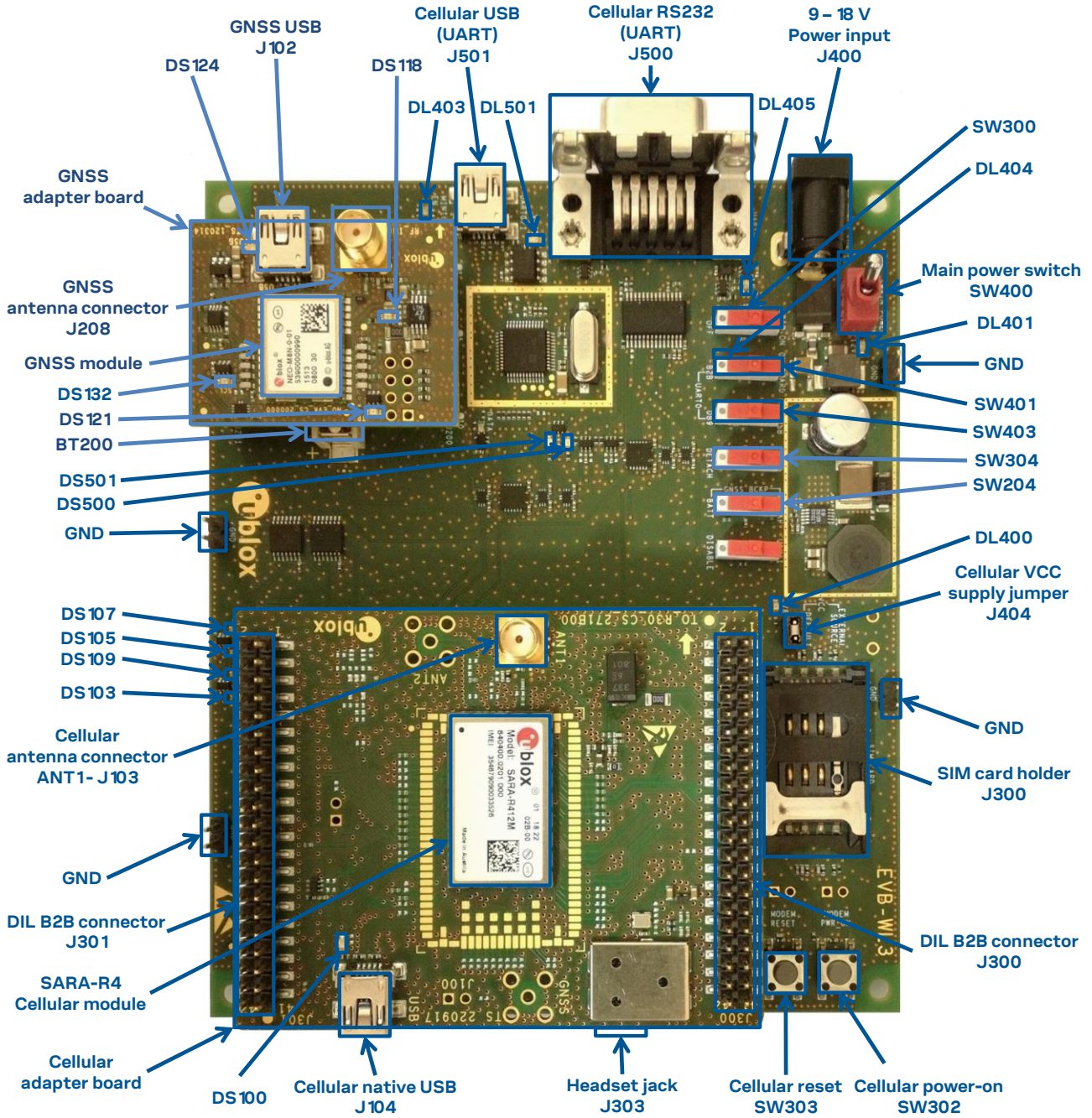

Figure 3: Overview of the EVK-R412M evaluation kit for SARA-R412M modules

## 1.2 EVK-R4 block diagram

Figure 4 shows the main interfaces and internal connections of the EVK-R4 evaluation kit:

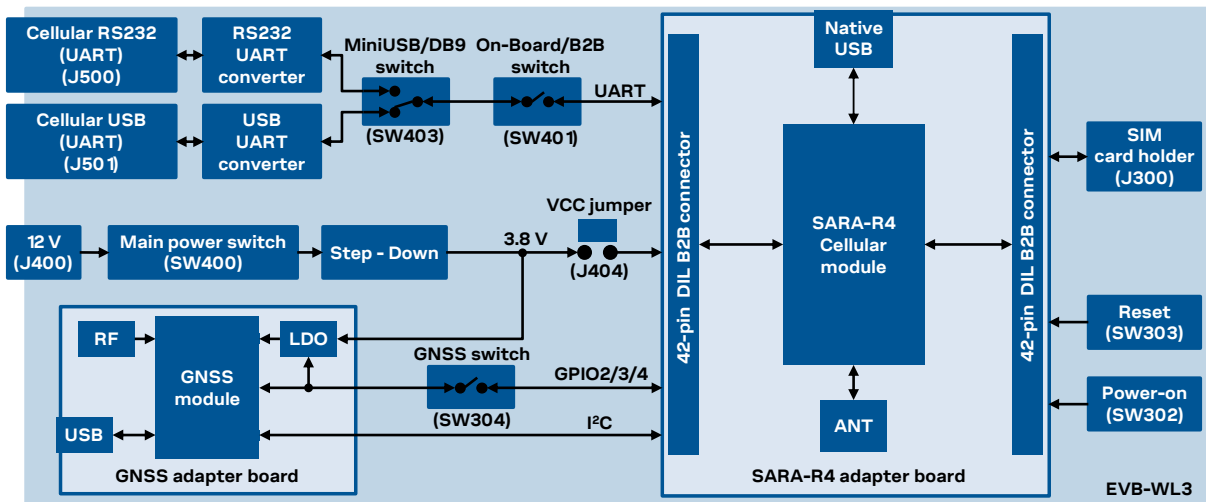

Figure 4: Block diagram of the EVK-R4 for SARA-R4 modules

The EVK-R4 is formed by three boards:

- The lower one, called EVB-WL3, contains the power supply and other peripherals for the SARA-R4 series cellular module (SIM card holder, Reset button and Power-on button).
- The cellular adapter board, called ADP-R4, contains the SARA-R4 cellular module, the cellular antenna connector and the USB connector for the cellular module.
- The GNSS adapter board, called ADP-GNSS, contains the u-blox GNSS module, the GNSS antenna connector and the USB connector for the GNSS module.

The boards are connected by means of male header board-to-board connectors provided on the bottom of the adapter boards and their corresponding female connectors provided on top of the lower board.

The USB interface of the cellular module is available on the native USB connector on the cellular adapter board, while the other peripherals are available on the dual-in-line male board-to-board connectors provided on the top layer of the cellular adapter board, which are pin-to-pin compatible to the connectors on the bottom layer of the adapter board.

The lower board (EVB-WL3) is designed to also be used with other u-blox cellular adapter boards. It contains additional switches, jumpers, connectors, LEDs and parts that are only partially described in [Figure 1](#), [Figure 2](#), [Figure 3](#), and in this document, because they are intended for use only with other u-blox cellular modules. It is recommended to leave any additional connector unconnected, and to leave any additional switch in its default configuration.





















## 1.3 Switches, jumpers and buttons

Function	Description	Name	Board
Main power switch	Power on / off of the whole evaluation kit	SW400	EVB
Cellular VCC	Jumper socket to provide the 3.8 V supply to the cellular module VCC input	J404	EVB
Cellular power on	Push button to switch on the cellular module	SW302	EVB
Cellular reset	Push button to reset the cellular module	SW303	EVB
Cellular UART detach	Slide switch to attach / detach the cellular module UART from the USB / RS232 connectors: when detached, UART signals are available only on the DIL B2B connector on the ADP board	SW401	EVB
Cellular UART routing	Slide switch to select cellular module UART routing on the USB or RS232 connector	SW403	EVB
Cellular GPIO detach	Slide switch to attach / detach the cellular module GPIOs, SIM_DET from peripherals: when detached, the signals are available only on the DIL B2B connector on the ADP board	SW300	EVB
Cellular GNSS detach	Slide switch to attach / detach the cellular module to / from the GNSS module (GPIO2-3-4): when detached, the signals are available only on the DIL B2B connector on the ADP board	SW304	EVB
GNSS V_BCKP	Slide switch to connect / disconnect backup battery to / from the V_BCKP pin of the GNSS module	SW204	EVB

**Table 1: EVK-R4 switch and button descriptions**

## 1.4 LEDs



Function	Description	LED #	Board	Color
Main power	Power supply plugged in the <b>9 - 18 V Power Input</b>	DL401	EVB	
Cellular VCC	Cellular module supplied. <b>Main power switch</b> must be switched on	DL400	EVB	
Cellular native USB	USB cable plugged in the <b>Cellular native USB</b> connector for USB access	DS102	ADP-R404M	
		DS100	ADP-R410M ADP-R412M	
Cellular USB	USB cable plugged in the <b>Cellular USB</b> connector for UART access	DL501	EVB	
Cellular USB / UART	Green light is on when UART is routed to the <b>Cellular USB</b> connector Red light blinks at UART TX or RX data on the <b>Cellular USB</b> connector	DL403	EVB	
Cellular UART detach	UART signals are available only on the DIL B2B connector on ADP board	DL404	EVB	
Cellular RS232 / UART	Green light is on when UART is routed to the <b>Cellular RS232</b> connector Red light blinks at UART TX / RX data on the <b>Cellular RS232</b> connector	DL405	EVB	
Cellular RI indicator	RI line turns ON (active low)	DS501	EVB	
Cellular CTS indicator	CTS line turns ON (active low)	DS500	EVB	
Cellular GPIO1 indicator	Green light is activated when cellular GPIO1 is high	DS107	EVB	
Cellular GPIO2 indicator	Green light is activated when cellular GPIO2 is high	DS105	EVB	
Cellular GPIO3 indicator	Green light is activated when cellular GPIO3 is high	DS109	EVB	
Cellular GPIO4 indicator	Green light is activated when cellular GPIO4 is high	DS103	EVB	
GNSS VCC supply	GNSS module supply is turned ON	DS118	ADP-GNSS	
GNSS USB	USB cable plugged into the <b>GNSS USB</b> connector	DS124	ADP-GNSS	
GNSS Timepulse	Pulses at 1 Hz when valid GNSS fix	DS121	ADP-GNSS	
Cellular / GNSS DDC	Cellular / GNSS module communication over the DDC (I2C) interface	DS132	ADP-GNSS	

**Table 2: EVK-R4 LED descriptions**

## 1.5 Connectors

Function	Description	Name	Board
9 - 18 V Power Input	Connector for the AC / DC power adapter of the EVK AC: 100-240 V, 0.8 A, 50-60 Hz / DC: +12 V, 2.5 A 	J400	
SIM card holder	SIM card holder	J300	EVB
Cellular antenna	SMA connector for the cellular module antenna (ANT, Tx/Rx)	J106	ADP-R404M
		J103	ADP-R410M ADP-R412M
Cellular native USB	Mini USB connector for the cellular module native USB interface	J105	ADP-R404M
		J104	ADP-R410M ADP-R412M
Cellular USB (UART)	Mini USB connector for the cellular module UART interface converted as a USB interface	J501	EVB
Cellular RS232 (UART)	DB9 connector for the cellular module UART interface converted as an RS232 interface	J500	EVB
DIL B2B headers	Dual-in-line board-to-board connectors for cellular module interfaces	J101, J102	ADP-R404M
		J300, J301	ADP-R410M ADP-R412M
Cellular headset	Audio headset jack connector for the cellular module audio interface	J303	EVB
GNSS antenna	SMA connector for the GNSS module antenna (GNSS Antenna)	J208	ADP-GNSS
GNSS USB	Mini USB connector for the GNSS module USB interface	J102	ADP-GNSS
GNSS backup battery	Backup battery socket for the GNSS module (under GNSS adapter board)	BT200	EVB
GND	Ground terminals for the probe reference	J402, J403	EVB
		J405, J406	

**Table 3: EVK-R4 connector descriptions**

-  CAUTION! IN THE UNLIKELY EVENT OF A FAILURE IN THE INTERNAL PROTECTION CIRCUITRY, THERE IS A RISK OF AN EXPLOSION WHEN CHARGING A FULLY OR PARTIALLY DISCHARGED BATTERY. REPLACE THE BATTERY WHEN IT NO LONGER HAS A SUFFICIENT CHARGE FOR UNIT OPERATION. CONTROL THE BATTERY BEFORE USE IF THE DEVICE HAS NOT BEEN USED FOR AN EXTENDED PERIOD OF TIME.
-  CAUTION! RISK OF EXPLOSION IF THE BATTERY IS REPLACED WITH AN INCORRECT TYPE. DISPOSE OF USED BATTERIES ACCORDING TO THE INSTRUCTIONS!

## 1.6 EVK-R404M pin out

SARA-R404M		DIL B2B		SARA-R404M		DIL B2B	
Pin N°	Name	Name / Pin N°	Pin N°	Name	Name / Pin N°	Pin N°	Name
1	GND	J102 pins 7-8-9-10	33	RSVD	Not available		
2	RSVD	Not available	34	I2S_WA	J101 pin 25		
3	GND	J102 pins 7-8-9-10	35	I2S_TXD	J101 pin 24		
4	V_INT	J102 pin 36	36	I2S_CLK	J101 pin 22		
5	GND	J102 pins 7-8-9-10	37	I2S_RXD	J101 pin 23		
6	DSR	J102 pin 18	38	SIM_CLK	J101 pin 15		
7	RI	J102 pin 17	39	SIM_IO	J101 pin 14		
8	DCD	J102 pin 11	40	SIM_RST	J101 pin 16		
9	DTR	J102 pin 12	41	VSIM	J101 pin 13		
10	RTS	J102 pin 13	42	GPIO5	J102 pin 23		
11	CTS	J102 pin 14	43	GND	J102 pins 7-8-9-10		
12	TXD	J102 pin 15	44	SDIO_D2	J102 pin 30		
13	RXD	J102 pin 16	45	SDIO_CLK	J101 pin 19		
14	GND	J102 pins 7-8-9-10	46	SDIO_CMD	J101 pin 18		
15	PWR_ON	J102 pin 29	47	SDIO_D0	J101 pin 17		
16	GPIO1	J102 pin 33	48	SDIO_D3	J102 pin 39		
17	VUSB_DET	Not available	49	SDIO_D1	J102 pin 37		
18	RESET_N	J101 pin 26	50	GND	J102 pins 7-8-9-10		
19	GPIO6	Not available	51	VCC	J101 pins 7-8-9-10		
20	GND	J102 pins 7-8-9-10	52	VCC	J101 pins 7-8-9-10		
21	GND	J102 pins 7-8-9-10	53	VCC	J101 pins 7-8-9-10		
22	GND	J102 pins 7-8-9-10	54	GND	J102 pins 7-8-9-10		
23	GPIO2	J102 pin 31	55	GND	J102 pins 7-8-9-10		
24	GPIO3	J102 pin 32	56	ANT	Not available		
25	GPIO4	J102 pin 25	57	GND	J102 pins 7-8-9-10		
26	SDA	J101 pin 21	58	GND	J102 pins 7-8-9-10		
27	SCL	J101 pin 20	59	GND	J102 pins 7-8-9-10		
28	USB_D-	Not available	60	GND	J102 pins 7-8-9-10		
29	USB_D+	Not available	61	GND	J102 pins 7-8-9-10		
30	GND	J102 pins 7-8-9-10	62	ANT_DET	Not available		
31	RSVD	Not available	63	GND	J102 pins 7-8-9-10		
32	GND	J102 pins 7-8-9-10	64	GND	J102 pins 7-8-9-10		

**Table 4: Interfaces of the SARA-R404M module, as routed on the 42-pin dual-in-line board-to-board connectors (J101, J102) available on the adapter board ADP-R404M of the EVK-R404M evaluation kit**

 The pins / interfaces that are not supported by a specific SARA-R4 module product version should be not driven by an external device (see the SARA-R4 series data sheet [2] and the SARA-R4 series system integration manual [3] for the features supported by each SARA-R4 module product version).

## 1.7 EVK-R410M pin out

SARA-R410M		DIL B2B		SARA-R410M		DIL B2B	
Pin N°	Name	Name / Pin N°	Pin N°	Name	Name / Pin N°	Pin N°	Name
1	GND	J301 pins 7-8-9-10	33	RSVD	Not available		
2	RSVD	J301 pin 3	34	I2S_WA	Not available		
3	GND	J301 pins 7-8-9-10	35	I2S_TXD	Not available		
4	V_INT	J301 pin 36	36	I2S_CLK	Not available		
5	GND	J301 pins 7-8-9-10	37	I2S_RXD	Not available		
6	DSR	J301 pin 18	38	SIM_CLK	J300 pin 15		
7	RI	J301 pin 17	39	SIM_IO	J300 pin 14		
8	DCD	J301 pin 11	40	SIM_RST	J300 pin 16		
9	DTR	J301 pin 12	41	VSIM	J300 pin 13		
10	RTS	J301 pin 13	42	GPIO5	J301 pin 23		
11	CTS	J301 pin 14	43	GND	J301 pins 7-8-9-10		
12	TXD	J301 pin 15	44	SDIO_D2	J301 pin 30		
13	RXD	J301 pin 16	45	SDIO_CLK	J300 pin 19		
14	GND	J301 pins 7-8-9-10	46	SDIO_CMD	J300 pin 18		
15	PWR_ON	J301 pin 29	47	SDIO_D0	J300 pin 17		
16	GPIO1	J301 pin 33	48	SDIO_D3	J301 pin 39		
17	VUSB_DET	Not available	49	SDIO_D1	J301 pin 37		
18	RESET_N	J300 pin 26	50	GND	J301 pins 7-8-9-10		
19	GPIO6	Not available	51	VCC	J300 pins 7-8-9-10		
20	GND	J301 pins 7-8-9-10	52	VCC	J300 pins 7-8-9-10		
21	GND	J301 pins 7-8-9-10	53	VCC	J300 pins 7-8-9-10		
22	GND	J301 pins 7-8-9-10	54	GND	J301 pins 7-8-9-10		
23	GPIO2	J301 pin 31	55	GND	J301 pins 7-8-9-10		
24	GPIO3	J301 pin 32	56	ANT	Not available		
25	GPIO4	J301 pin 25	57	GND	J301 pins 7-8-9-10		
26	SDA	J300 pin 21	58	GND	J301 pins 7-8-9-10		
27	SCL	J300 pin 20	59	GND	J301 pins 7-8-9-10		
28	USB_D-	Not available	60	GND	J301 pins 7-8-9-10		
29	USB_D+	Not available	61	GND	J301 pins 7-8-9-10		
30	GND	J301 pins 7-8-9-10	62	ANT_DET	Not available		
31	RSVD	Not available	63	GND	J301 pins 7-8-9-10		
32	GND	J301 pins 7-8-9-10	64	GND	J301 pins 7-8-9-10		

**Table 5: Interfaces of the SARA-R410M module, as routed on the 42-pin dual-in-line board-to-board connectors (J300, J301) available on the adapter board ADP-R410M of the EVK-R410M evaluation kit**

 The pins / interfaces that are not supported by a specific SARA-R4 module product version should be not driven by an external device (see the SARA-R4 series data sheet [2] and the SARA-R4 series system integration manual [3] for the features supported by each SARA-R4 module product version).

## 1.8 EVK-R412M pin out

SARA-R412M		DIL B2B		SARA-R412M		DIL B2B	
Pin N°	Name	Name / Pin N°	Pin N°	Name	Name / Pin N°	Name / Pin N°	
1	GND	J301 pins 7-8-9-10	33	RSVD		Not available	
2	RSVD	J301 pin 3	34	I2S_WA		Not available	
3	GND	J301 pins 7-8-9-10	35	I2S_TXD		Not available	
4	V_INT	J301 pin 36	36	I2S_CLK		Not available	
5	GND	J301 pins 7-8-9-10	37	I2S_RXD		Not available	
6	DSR	J301 pin 18	38	SIM_CLK		J300 pin 15	
7	RI	J301 pin 17	39	SIM_IO		J300 pin 14	
8	DCD	J301 pin 11	40	SIM_RST		J300 pin 16	
9	DTR	J301 pin 12	41	VSIM		J300 pin 13	
10	RTS	J301 pin 13	42	GPIO5		J301 pin 23	
11	CTS	J301 pin 14	43	GND		J301 pins 7-8-9-10	
12	TXD	J301 pin 15	44	SDIO_D2		J301 pin 30	
13	RXD	J301 pin 16	45	SDIO_CLK		J300 pin 19	
14	GND	J301 pins 7-8-9-10	46	SDIO_CMD		J300 pin 18	
15	PWR_ON	J301 pin 29	47	SDIO_D0		J300 pin 17	
16	GPIO1	J301 pin 33	48	SDIO_D3		J301 pin 39	
17	VUSB_DET	Not available	49	SDIO_D1		J301 pin 37	
18	RESET_N	J300 pin 26	50	GND		J301 pins 7-8-9-10	
19	GPIO6	J301 pin 24	51	VCC		J300 pins 7-8-9-10	
20	GND	J301 pins 7-8-9-10	52	VCC		J300 pins 7-8-9-10	
21	GND	J301 pins 7-8-9-10	53	VCC		J300 pins 7-8-9-10	
22	GND	J301 pins 7-8-9-10	54	GND		J301 pins 7-8-9-10	
23	GPIO2	J301 pin 31	55	GND		J301 pins 7-8-9-10	
24	GPIO3	J301 pin 32	56	ANT		Not available	
25	GPIO4	J301 pin 25	57	GND		J301 pins 7-8-9-10	
26	SDA	J300 pin 21	58	GND		J301 pins 7-8-9-10	
27	SCL	J300 pin 20	59	GND		J301 pins 7-8-9-10	
28	USB_D-	Not available	60	GND		J301 pins 7-8-9-10	
29	USB_D+	Not available	61	GND		J301 pins 7-8-9-10	
30	GND	J301 pins 7-8-9-10	62	ANT_DET		Not available	
31	RSVD	Not available	63	GND		J301 pins 7-8-9-10	
32	GND	J301 pins 7-8-9-10	64	GND		J301 pins 7-8-9-10	

**Table 6: Interfaces of the SARA-R412M module, as routed on the 42-pin dual-in-line board-to-board connectors (J300, J301) available on the adapter board ADP-R412M of the EVK-R412M evaluation kit**

 The pins / interfaces that are not supported by a specific SARA-R4 product version should be not driven by an external device (see the SARA-R4 series data sheet [2] and the SARA-R4 series system integration manual [3] for features supported by each SARA-R4 module product version).

## 1.9 Software installation

The USB drivers for Windows operating systems are available with the EVK-R4. Executable files can be downloaded from [www.u-blox.com/evk-downloads](http://www.u-blox.com/evk-downloads) and saved to any location on the computer hard drive. The installation can be started by running the executable file on a computer with the Windows operating system.

## 1.10 Board setup

1. Insert a SIM card into the **SIM card holder** (J300 on the EVB).
2. Connect the cellular antenna provided with the evaluation kit box to the **Cellular antenna SMA** connector on the ADP-R4 (ANT connector for transmission and reception of LTE RF signals)
3. If the GNSS functionality is required, connect the GNSS antenna provided with the evaluation kit box to the **GNSS antenna SMA** connector on the EVB. Place the GNSS antenna in a location with a good view of the sky.

 Interface to the GNSS module is not supported by the “00” and “01” product versions of SARA-R4 modules<sup>1</sup>.

4. Connect the AC / DC +12 V power adapter provided with the evaluation kit box to the **9 – 18 V Power input** connector (J400 on the EVB). The LED DL401 lights blue.
5. Be sure to provide a jumper socket on the **Cellular VCC supply jumper** (J404 on the EVB). This provides the connection from the 3.8 V output of the supply circuit on the EVB to the VCC input of the module.
6. To enable the board power supply, turn the **Main power switch** (SW400 on the EVB) to the ON position. The LED DL400 lights green.
7. For communication via the cellular module’s USB interface, connect a USB cable to the **Cellular native USB** connector on the ADP-R4. The related LED lights blue.

After the end of the module boot (refer to point 9 for the procedure to switch-on the cellular module), the COM ports listed in [Table 7](#) are enabled by the Windows USB driver (details as the numbering of the ports can be seen via the Windows Device Manager):

Type	Remarks
Modems	AT command interface and data communication
Ports (COM & LPT)	Diagnostic purpose

**Table 7: Cellular USB interface configuration**

Run an AT terminal application (e.g. the u-blox m-center tool) selecting an AT port.

- Data rate: 115,200 bit/s
- Data bits: 8
- Parity: N
- Stop bits: 1
- Flow control: HW

See [Appendix A](#) for how to configure the u-blox m-center AT terminal for Windows.

8. For communication via the cellular module’s UART interface, the following connections are allowed and can be alternatively enabled in a mutually exclusive way (see [Table 8](#) for the switch position and LED status):
  - 8.1. Connect a USB cable to the mini USB connector (**Cellular USB**, J501 on EVB). The LED DL501 lights blue. When a USB cable is connected to the mini USB connector, two COM ports are enabled in Windows (the numbering of the COM ports can be seen via the Windows Device Manager). The serial port for AT commands is available over the first numbered COM port opened by the driver.
  - 8.2. Connect an RS232 cable to the DB9 connector (**Cellular RS232**, J500 on EVB).

<sup>1</sup> Supply for the GNSS module can be provided mounting the 0R jumper R106 and removing the 0R jumper R107 on the ADP-GNSS

Type of connections	SW401	SW403	LED
Access to UART over the <b>Cellular USB (UART)</b> mini USB connector (J501)	ON BOARD	MINIUSB	DL403
Access to UART over the <b>Cellular RS232 (UART)</b> DB9 connector (J500)	ON BOARD	DB9	DL405
Access to UART on the DIL Board-to-Board connector on the adapter board: UART detached from USB (UART) J501 and RS232 (UART) J500 connectors	B2B	Do not care	DL404

**Table 8: Serial interface configuration**

Run an AT terminal application (e.g. the u-blox m-center tool) selecting an AT port, with these settings:

- Data rate: 115,200 bit/s
- Data bits: 8
- Parity: N
- Stop bits: 1
- Flow control: HW

See Appendix A for how to configure the u-blox m-center AT terminal for Windows.

9. To switch on the cellular module, press the **Cellular Power-on** button (SW302 on the EVB).

## 1.11 Enabling error result codes

Command sent by DTE (user)	DCE response (module)	Description
AT+CMEE=2	OK	Enables the cellular module to report verbose error result codes.

## 1.12 PIN code insertion (when required)

Command sent by DTE (user)	DCE response (module)	Description
AT+CPIN="8180"	OK	Enter the PIN code, if needed (enter the PIN of the SIM card – 8180 is written here as an example).
AT+CLCK="SC",0,"8180"	OK	Unlock the PIN at power-on (the last parameter is the PIN of the SIM card – 8180 is written here as an example).
AT+CLCK="SC",1,"8180"	OK	Lock the PIN at power-on (the last parameter is the PIN of the SIM card – 8180 is written here as an example).

## 1.13 Registration on a cellular network

Command sent by DTE (user)	DCE response (module)	Description
AT+CEREG?	+CEREG: 0,1 OK	Verify the network registration status.
AT+COPS?	+COPS: 0,0,"Verizon Wireless",7 OK	Read the operator name and radio access technology (RAT).

## 1.14 Switching off the EVK-R4

To switch off the EVK-R4, send the +CPWROFF AT command. Make sure to use this command before switching off the main power, otherwise settings and configuration parameters may not be saved in the internal non-volatile memory of the cellular module.

## Appendix

# A Setting up AT terminal applications for communication with the EVK-R4

The u-blox m-center cellular module evaluation tool is a powerful platform for evaluating, configuring and testing u-blox cellular products. m-center includes an AT commands terminal for communication with the device and can be downloaded free-of-charge from our website (<http://www.u-blox.com>).

1. Follow the board setup instructions in section 1.10 to provide all the required connections and switching on the cellular module.
2. Run the m-center tool: after the m-center start-up, the **Home** page appears.
3. On the **Home** page, set up the AT COM port; for the setting values, see section 1.10. Check with the Windows Device Manager to find out which COM port is being used by the EVK-R4.
4. Enable the connection to the u-blox cellular module by clicking on the **Connect** button.
5. Retrieve the module and network information by clicking on the **Get Info** button.
6. The module information is retrieved and displayed on the Home page.
7. Click on the **AT Terminal** button, found at the upper right of the **Home** page. A new window opens and the AT command terminal is now ready for communication with the EVK-R4.
8. The AT terminal is ready to use. For the complete list of AT commands supported by the modules and their syntax, see the SARA-R4 series AT commands manual [1].

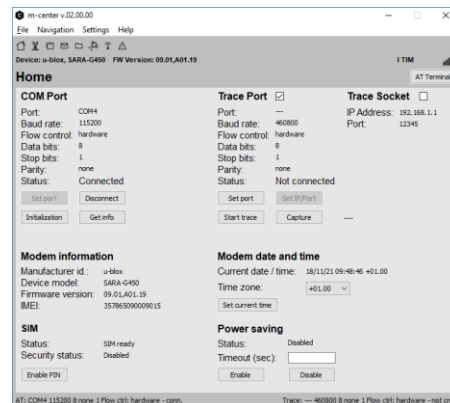

Figure 5: “Home” page

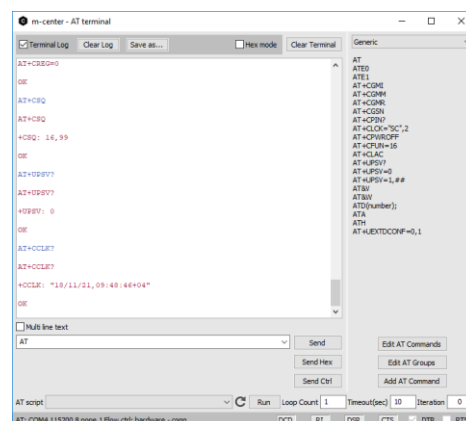

Figure 6: AT terminal window

For more information on using the u-blox m-center cellular module evaluation tool, press the F1 key on the keyboard to open the m-center help window on the computer.



## B Setting up a cellular packet data connection on a Windows PC

This section describes how to set up a packet data connection with the Windows 7 operating systems (for PC) and EVK-R4, using the TCP/IP stack of the PC (external TCP/IP stack).

The following examples describe how to install and configure two different kinds of modem on Windows:

1. Over the UART interface of the cellular module: connect the Windows PC to the **Cellular USB** connector (J501 on EVB) or the **Cellular RS232** connector (J500 on the EVB)
2. Over the native USB interface of the cellular module: connect the Windows PC to the **Cellular Native USB** connector (J105 on the ADP)

### B.1 How to install and configure a modem data connection over UART

This example describes how to install and configure a data connection on a PC with the Windows 7 operating system. This uses the TCP/IP stack of the PC over the UART interface of the cellular module connected to the Windows PC by the **Cellular USB** connector (J501 on EVB) or the **Cellular RS232** connector (J500 on the EVB).

1. Follow the board setup instructions in section 1.10 to provide the required connections with the EVK-R4.

2. Select “Control panel > Phones and Modem > Modems > Add”. This opens the Install New Modem Wizard.
3. Select the **Don't detect my modem** checkbox.

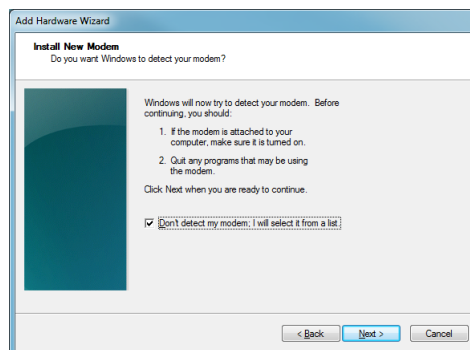

4. Select the **Standard Modem (33,600 bit/s)**.

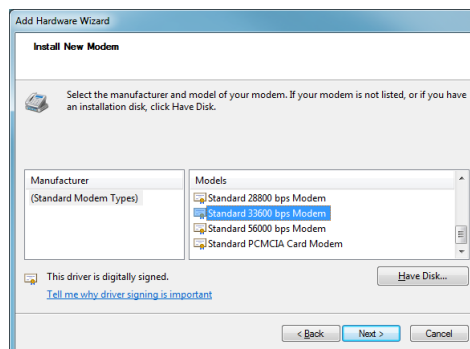

- Set the COM port on which the modem will be installed.

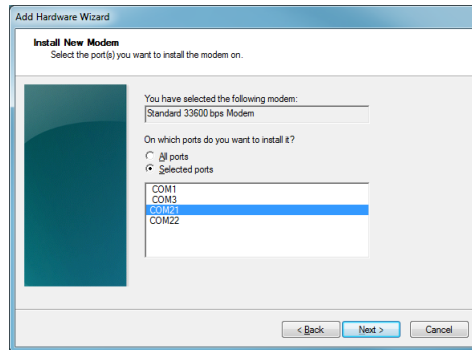

- From the "Device Manager"> Modems > Standard Modem 33,600 bps Modem #X (X is the assigned modem number) right click and select "Properties".
- Select the "Advanced" tab.
- Add in the "Extra initialization commands" string: **AT&S0**
- Click on **OK**.

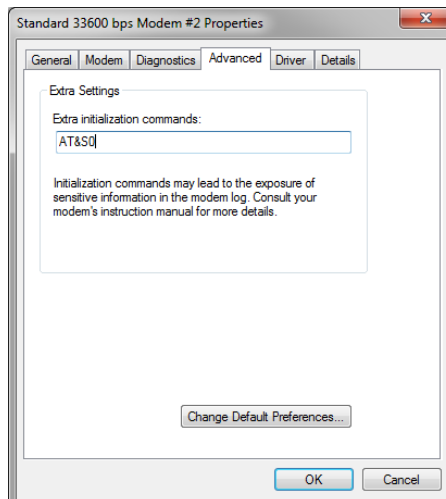

- Open the "Control Panel".

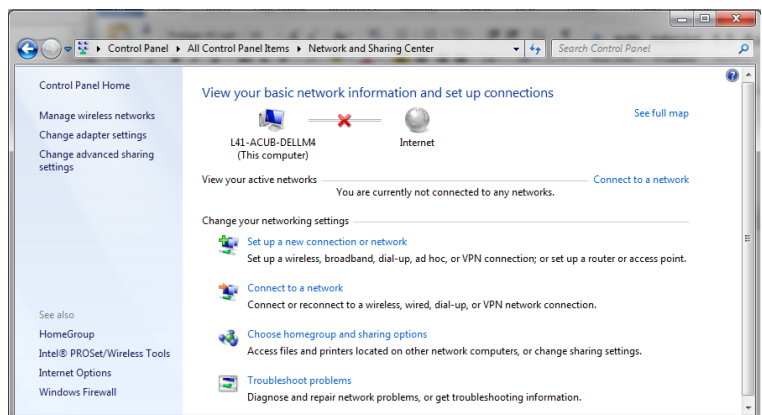

- Select "Set up a new connection or network".

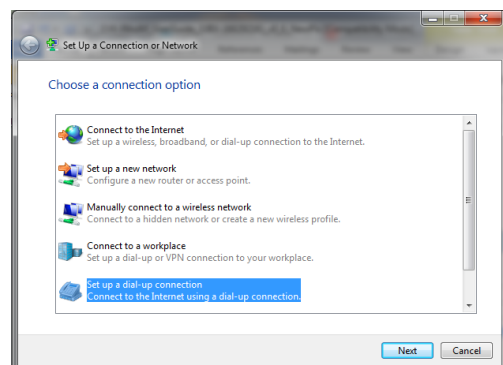

12. Select the modem, if requested (the question appears only if more than one modem is available).

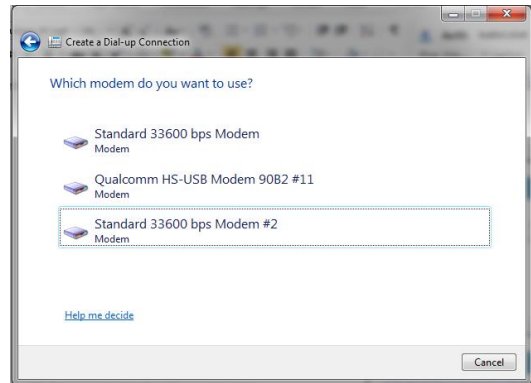

13. Enter parameters for dial-up connection:

- The module telephone number (\*99\*\*\*1#)
- The specific account information for the network operator (if needed)
- A name for the new connection

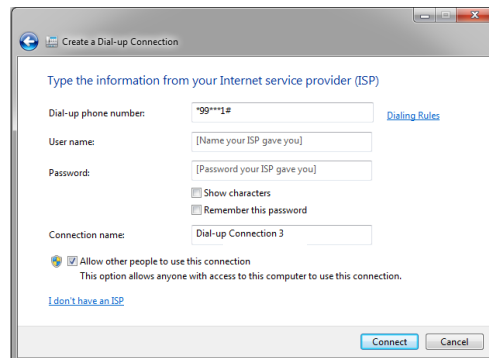

14. The packet data connection is now ready to be used with the EVK-R4. To check the connection, start a browser.



-  Consult the cellular network operator for the username and password. In most cases, these can be left empty.

## B.2 How to install and configure a modem data connection over USB

This example describes how to install and configure a data connection on a PC with the Windows 7 operating system using the TCP/IP stack of the PC, over the native USB interface of the cellular module connected to the Windows PC by the **Cellular Native USB** connector (J105 on the ADP).

1. Follow the board setup instructions in section 1.10 to provide the required connections with the EVK-R4.

2. Select: "Control Panel > Network and Internet > Network and Sharing Center > Setup a new connection or network" This opens the "Choose a connection option" Wizard.

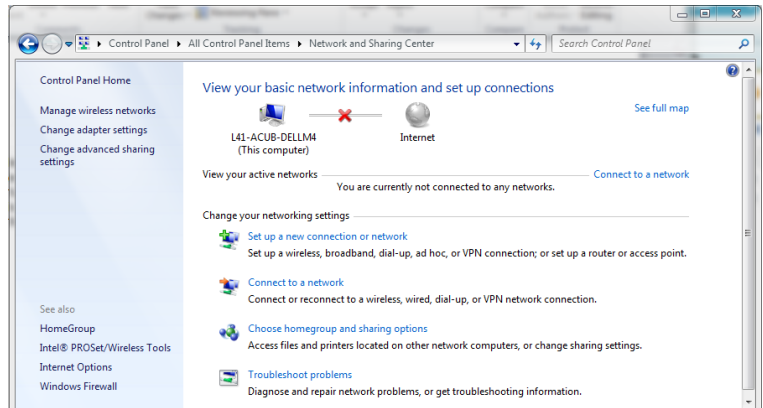

3. Select **Set up a dial-up connection**. Click on **Next**.

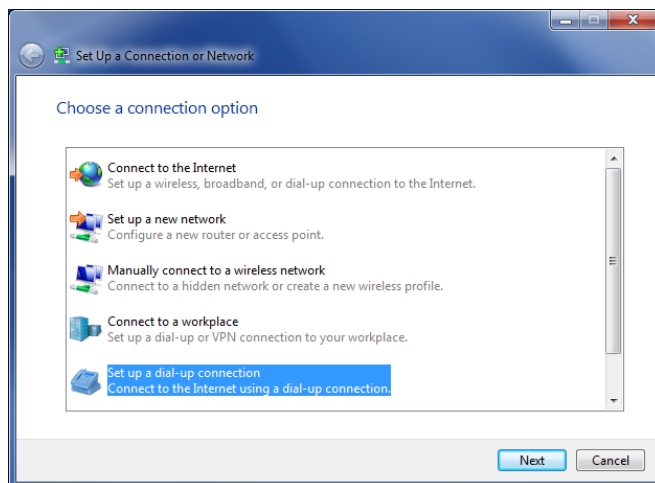

4. Select Qualcomm HS-USB Modem 90B2 #X (X=11 in the picture)

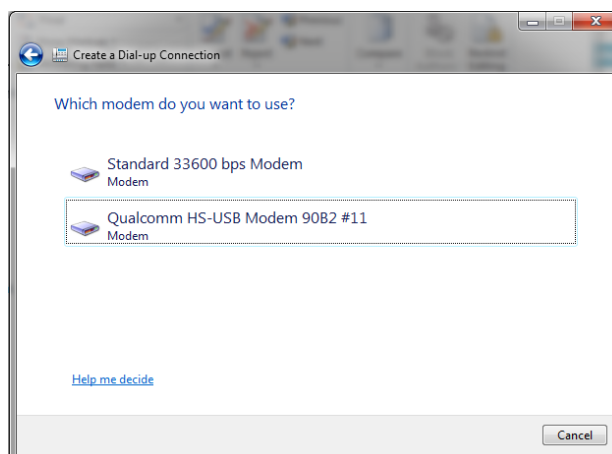

- Enter the modem telephone number (\*99\*\*\*1#), select **Allow other people to use this connection**.

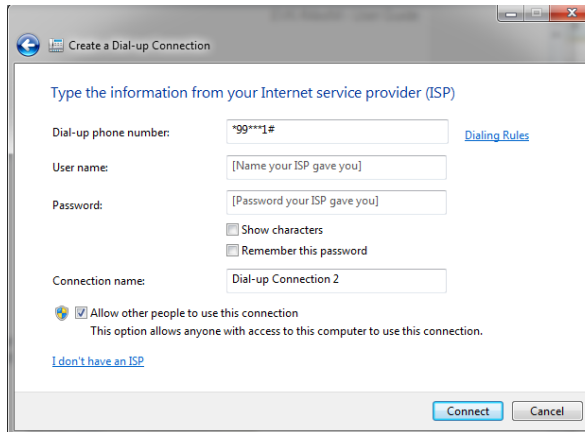

- Consult the cellular mobile network operator for the username and the password. In most cases, these can be left empty.

- From the “**Device Manager**”, select the modem **Qualcomm HS-USB Modem 90B2** under use and right click to show the “**Properties**” window:  
Add **AT&S0** on the “**Extra Initialization Command**” line and click OK.  
Then click **Connect** to finalize the procedure.

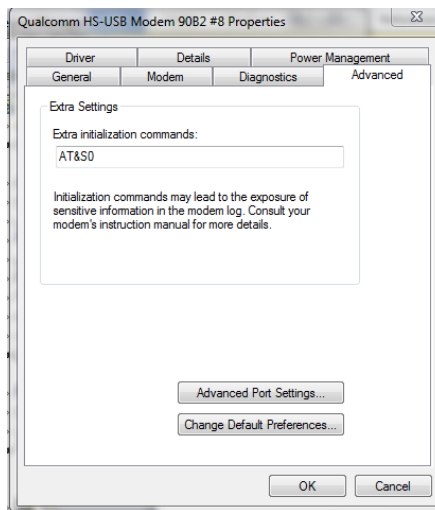

## C Examples of AT commands

For the complete description and syntax of the AT commands supported by SARA-R4 series cellular modules, see the u-blox SARA-R4 series AT commands manual [1].

For detailed examples of AT commands used for common operations, see the u-blox SARA-R4 series Application Development Guide [4].

### C.1 Data connection using external/internal TCP/IP stack

 There is no need to explicitly establish a PSD connection using SARA-R4 series modules. This device automatically establishes a PSD connection as part of the network registration and the attach procedure.

### C.2 Opening a TCP socket

Command sent by DTE (user)	DCE response (module)	Description
AT+CMEE=2	OK	Enables the cellular module to report verbose error result codes.
AT+CGATT?	+CGATT: 1 OK	Verifies the SARA-R4 module is attached to the network.
AT+CEREG?	+CEREG: 0,1 OK	Verify the network registration status.
AT+COPS=0	OK	Register the module on the network. The cellular module automatically registers itself on the cellular network. This command is necessary only if the automatic registration failed (AT+CEREG? returns 0,0).
AT+COPS?	+COPS: 0,0,"Verizon Wireless",7 OK	Read the operator name and radio access technology (RAT).
AT+USOCR=6	+USOCR: 0 OK	Create a TCP socket.
AT+USOCO=0,"195.34.89.241",7	OK	Connect to the server.
	+UUSORD: 0,32	Greeting message.
AT+USORD=0,32	+USORD: 0,32,"u-blox AG TCP/UDP test service" OK	Retrieving the message.
AT+USOCL=0	OK	Closing the socket.

## C.3 Opening a UDP socket

Command sent by DTE (user)	DCE response (module)	Description
AT+CMEE=2	OK	Enables the cellular module to report verbose error result codes.
AT+CGATT?	+CGATT: 1 OK	Verifies the SARA-R4 module is attached to the network.
AT+CEREG?	+CEREG: 0,1 OK	Verify the network registration status.
AT+COPS=0	OK	Register the module on the network. The cellular module automatically registers itself on the cellular network. This command is necessary only if the automatic registration failed (AT+CREG? returns 0,0).
AT+COPS?	+COPS: 0,0,"Verizon Wireless",7 OK	Read the operator name and radio access technology (RAT).
AT+USOCR=17	+USOCR: 0 OK	Create a UDP socket.
AT+USOST=0,"195.34.89.241",7,13,"TestNumberOne"	+USOST: 0,13 OK	Connecting and storing text on the server.
	+UUSORF: 0,13	Echo server returning the message.
AT+USORF=0,13	+USORF: 0,"195.34.89.241",7,13,"TestNumberOne" OK	Reading the message from the server.
AT+USOCL=0	OK	Closing the socket.

## D Current consumption measurement

The current consumption of SARA-R4 series modules can be measured on the EVK-R4 by removing the jumper socket from the **Cellular VCC supply jumper** (J404 on the EVB), described in [Figure 7](#).

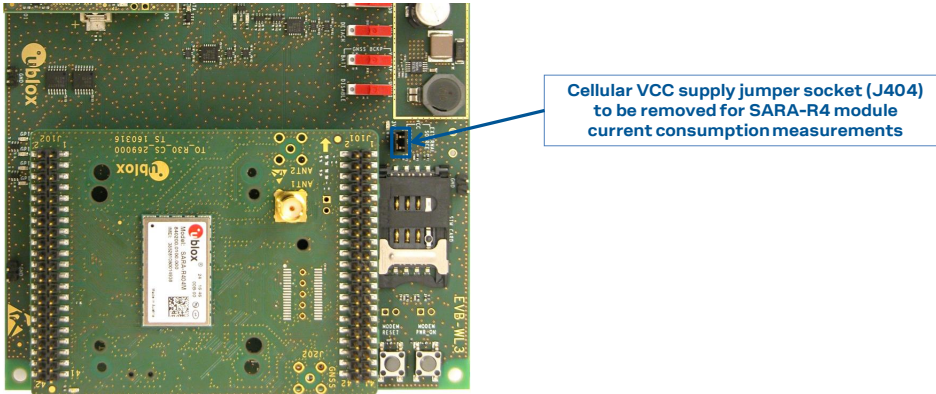

**Figure 7: Jumper socket to be removed for SARA-R4 series modules current consumption measurement**

A suitable external digital multi-meter (as for example the Keysight/Agilent 34465A, 34410A or 34411A) can be used for current consumption measurements. In this case, the 3.8 V supply circuit on the EVB will supply the SARA-R4 module mounted on the adapter board, with the digital multi-meter placed in series as illustrated in [Figure 8](#).

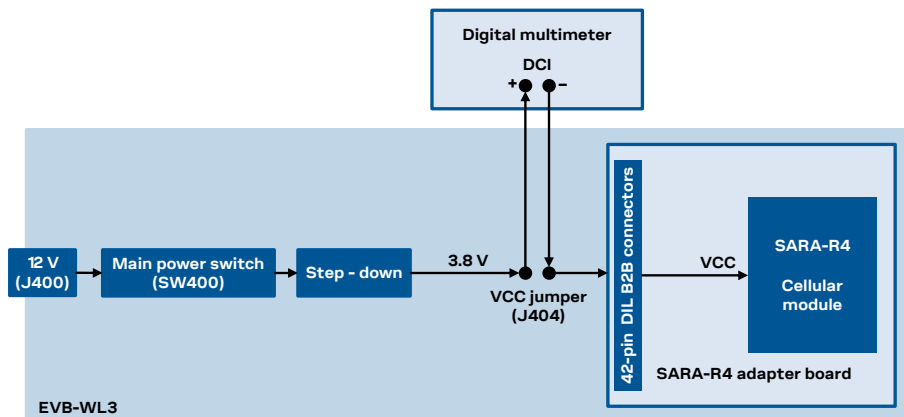

**Figure 8: Block diagram of current consumption setup for SARA-R4 series modules**

Alternatively, a suitable external DC power supply with the dynamic current measurement capabilities (as for example, the Agilent 66319B/D) can be used for current consumption measurements, acting also as the 3.8 V supply source for the SARA-R4 module mounted on the adapter board.



## E Glossary

Abbreviation	Definition
AC	Alternating current
ADP	Adapter Board
AT	AT Command Interpreter Software Subsystem, or attention
B2B	Board-To-Board
CTS	Clear To Send
DC	Direct Current
DCD	Data Carrier Detect
DCE	Data Communication Equipment
DDC	Display Data Channel interface
DIL	Dual In Line
DSR	DSC transponder response
DTE, TE	Data Terminal Equipment
DTR	Data Terminal Ready
EVB	Evaluation Board
GND	Ground
GNSS	Global Navigation Satellite System
GPIO	General Purpose Input Output
I2C	Inter-Integrated Circuit
IP	Internet Protocol
LED	Light Emitting Diode
LTE	Long Term Evolution
NB1	Narrowband IoT
PIN	Personal Identification Number
PSD	Packet-Switched Data
RAT	Radio Access Technology
RF	Radio Frequency
RI	Ring Indicator
RTS	Request To Send
Rx	Receiver
SIM	Subscriber Identity Module
SMA	Sub Miniature version A
TCP	Transfer Control Protocol
Tx	Transmitter
UART	Universal Asynchronous Receiver-Transmitter serial interface
UDP	User Datagram Protocol
USB	Universal Serial Bus

**Table 9: Explanation of the abbreviations and terms used**

## Declaration of conformities

The equipment is intended for indoor usage. It is the user's duty to verify if further restrictions apply, such as in airplanes, hospitals or hazardous locations (petrol stations, refineries...).

Any changes or modification made to this equipment will void its compliance to the safety requirements.

Maintenance, inspections and/or repairs of the EVK-R4 shall be performed by u-blox AG.

## Related documentation

- [1] u-blox SARA-R4 series AT commands manual, [UBX-17003787](#)
- [2] u-blox SARA-R4 series data sheet, [UBX-16024152](#)
- [3] u-blox SARA-R4 series system integration manual, [UBX-16029218](#)
- [4] u-blox SARA-R4 series application development guide, [UBX-18019856](#)

All these documents are available on our website (<http://www.u-blox.com>).

 For regular updates to u-blox documentation and to receive product change notifications, register on our homepage ([www.u-blox.com](http://www.u-blox.com)).

## Revision history

Revision	Date	Name	Comments
R01	24-May-2017	sfal/sses/acub	Initial release
R02	19-Jul-2017	sses	Added EVK-R410M-02B and updated EVK-R404M-00B product status
R03	17-Aug-2017	sses	Updated EVK-R410M-01B product status
R04	04-Jan-2018	sses	Updated EVK-R410M-01B and EVK-R410M-02B product status
R05	23-Dec-2019	sses	Added EVK-R410M-52B, EVK-R410M-6, EVK-R410M-7, EVK-R412M-02B. Updated EVK-R404M-00B, EVK-R410M-01B, EVK-R410M-02B product status.
R06	23-Feb-2021	sses	Added EVK-R410M-8. Updated EVK-R410M-6, EVK-R410M-7, EVK-R410M-02B-00, EVK-R412M-02B-00 product status.

# Contact

For complete contact information, visit us at [www.u-blox.com](http://www.u-blox.com).

## u-blox Offices

### North, Central and South America

#### u-blox America, Inc.

Phone: +1 703 483 3180  
Email: [info\\_us@u-blox.com](mailto:info_us@u-blox.com)

#### Regional Office West Coast:

Phone: +1 408 573 3640  
Email: [info\\_us@u-blox.com](mailto:info_us@u-blox.com)

#### Technical Support:

Phone: +1 703 483 3185  
Email: [support@u-blox.com](mailto:support@u-blox.com)

### Headquarters

#### Europe, Middle East, Africa

#### u-blox AG

Phone: +41 44 722 74 44  
Email: [info@u-blox.com](mailto:info@u-blox.com)  
Support: [support@u-blox.com](mailto:support@u-blox.com)

### Asia, Australia, Pacific

#### u-blox Singapore Pte. Ltd.

Phone: +65 6734 3811  
Email: [info\\_ap@u-blox.com](mailto:info_ap@u-blox.com)  
Support: [support\\_ap@u-blox.com](mailto:support_ap@u-blox.com)

#### Regional Office Australia:

Phone: +61 3 9566 7255  
Email: [info\\_anz@u-blox.com](mailto:info_anz@u-blox.com)  
Support: [support\\_ap@u-blox.com](mailto:support_ap@u-blox.com)

#### Regional Office China (Beijing):

Phone: +86 10 68 133 545  
Email: [info\\_cn@u-blox.com](mailto:info_cn@u-blox.com)  
Support: [support\\_cn@u-blox.com](mailto:support_cn@u-blox.com)

#### Regional Office China (Chongqing):

Phone: +86 23 6815 1588  
Email: [info\\_cn@u-blox.com](mailto:info_cn@u-blox.com)  
Support: [support\\_cn@u-blox.com](mailto:support_cn@u-blox.com)

#### Regional Office China (Shanghai):

Phone: +86 21 6090 4832  
Email: [info\\_cn@u-blox.com](mailto:info_cn@u-blox.com)  
Support: [support\\_cn@u-blox.com](mailto:support_cn@u-blox.com)

#### Regional Office China (Shenzhen):

Phone: +86 755 8627 1083  
Email: [info\\_cn@u-blox.com](mailto:info_cn@u-blox.com)  
Support: [support\\_cn@u-blox.com](mailto:support_cn@u-blox.com)

#### Regional Office India:

Phone: +91 80 405 092 00  
Email: [info\\_in@u-blox.com](mailto:info_in@u-blox.com)  
Support: [support\\_in@u-blox.com](mailto:support_in@u-blox.com)

#### Regional Office Japan (Osaka):

Phone: +81 6 6941 3660  
Email: [info\\_jp@u-blox.com](mailto:info_jp@u-blox.com)  
Support: [support\\_jp@u-blox.com](mailto:support_jp@u-blox.com)

#### Regional Office Japan (Tokyo):

Phone: +81 3 5775 3850  
Email: [info\\_jp@u-blox.com](mailto:info_jp@u-blox.com)  
Support: [support\\_jp@u-blox.com](mailto:support_jp@u-blox.com)

#### Regional Office Korea:

Phone: +82 2 542 0861  
Email: [info\\_kr@u-blox.com](mailto:info_kr@u-blox.com)  
Support: [support\\_kr@u-blox.com](mailto:support_kr@u-blox.com)

#### Regional Office Taiwan:

Phone: +886 2 2657 1090  
Email: [info\\_tw@u-blox.com](mailto:info_tw@u-blox.com)  
Support: [support\\_tw@u-blox.com](mailto:support_tw@u-blox.com)