

THIS DRAWING CONTAINS INFORMATION PROPRIETARY TO RF INDUSTRIES.
 ANY UNAUTHORIZED USE OF THIS DRAWING IS EXPRESSLY PROHIBITED
 WITHOUT WRITTEN PERMISSION FROM RF INDUSTRIES.
 ANY VIOLATION IS PUNISHABLE UNDER U.S. COPYRIGHT LAWS.

ALL DIMENSIONS ARE REFERENCE ONLY

PART NO.

RFT-1813

REV	DESCRIPTION	DWN	DATE	APPROVED
A	ENGINEERING RELEASE	CZS	10/12/98	R. RICE
B	CHG. DIM'S THROUGHOUT, FORMAT & DWG # 8967	GGG	2/11/02	JDMc

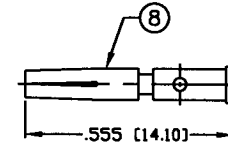
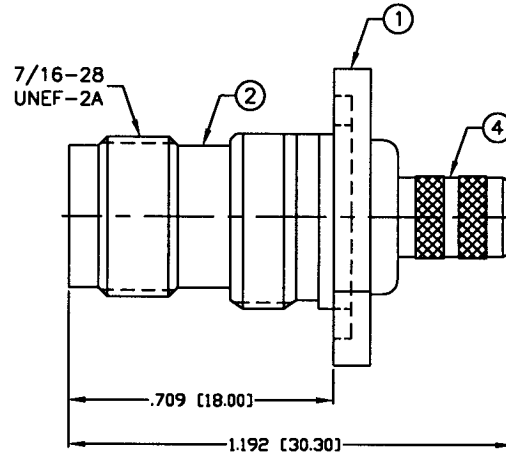
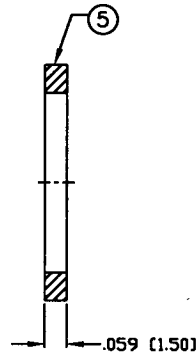
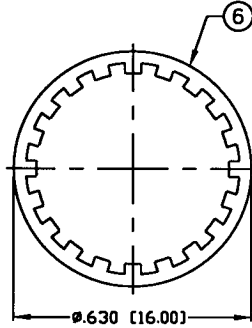
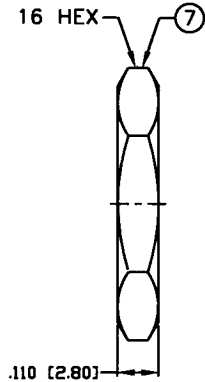

RECOMMENDED
CRIMP DIE: .068"

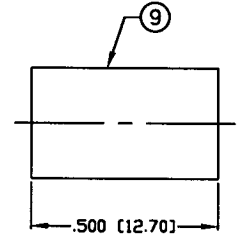

RECOMMENDED
CRIMP DIE: .255"

MAX. PANEL THICKNESS = .138 [3.50]

SPECIFICATIONS:

IMPEDANCE: 75 Ohms
 FREQUENCY RANGE: 0-2 GHz
 WORKING VOLTAGE: 500 VRMS
 INSULATION RESISTANCE: 5k M ohms min.
 TEMPERATURE RANGE: -65°C TO 85°C
 FOR RG-59, 59A, 59B, 62, 62A, 62C 71, 140 & 210/U,
 BELDEN 8221, 8241, 8241A, 8254, 8255, 8263, 9169,
 9204, 9228, 9244, 9269 & 9862 CABLE

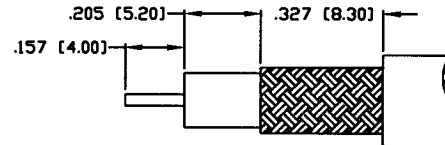

RECOMMENDED
STRIPPING DIMENSIONS

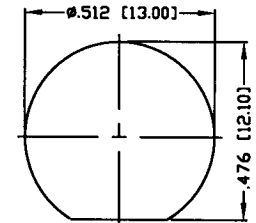

RECOMMENDED
MOUNTING HOLE

1	BODY	1	BRASS	NICKEL, 100μ"
2	TNC BODY	1	BRASS	NICKEL, 100μ"
3	INSULATOR	1	DELTRIN	---
4	FERRULE STUD	1	BRASS	NICKEL, 100μ"
5	GASKET	1	RUBBER	---
6	WASHER	1	BRASS	NICKEL, 100μ"
7	HEX NUT	1	BRASS	NICKEL, 100μ"
8	CONTACT	1	PHOS BRONZE	GOLD, 3μ"
9	FERRULE	1	BRASS	NICKEL, 100μ"

008974

UNLESS OTHERWISE SPECIFIED:

1. REMOVE ALL BURRS
2. BREAK ALL CORNERS & EDGES .005 R. MAX.
3. CHAMFER 1ST & LAST THREADS 45°
4. SURFACE ROUGHNESS 6.3 FINISH MIL-STD-10
5. DIAMETERS ON COMMON CENTERS TO BE CONCENTRIC WITHIN .002 T.I.R.
6. ALL DIMENSIONS ARE AFTER PLATING.

DIMENSIONS ARE IN INCHES
AND [MILLIMETERS]

UNLESS OTHERWISE NOTED
TOLERANCES ARE:

DECIMALS	DIAMETER
.xxx±.003 [.08]	.xxx±.001 [.03]
.xx±.005 [.13]	.xx±.003 [.08]

RF connectors
DIVISION OF RF INDUSTRIES, LTD.

7610 MIRAMAR RD
 SAN DIEGO, CA 92126
 (858) 549-6340
 (858) 549-6345 FAX

TNC JACK, CRIMP

BULKHEAD

SIZE	CABLE GROUP	DWG NO.	REV
A	D	RFT-1813	B
SCALE: NTS		CAD FILE OUTLINE	SHEET 1 OF 1

#	DESCRIPTION	QTY	MATERIAL	FINISH	APPROVALS	DATE
10						
11						
12						
13						
14						

DRAWN	G. CALLEGOS	2/11/02
CHECKED	<i>[Signature]</i>	2-11-02
ORJ DRAWN	C. ZUNIGA	10/12/98