



American Opto Plus LED Corp.

L513UBC-S

5mm Blue LED Lamp with Stand Off

DESCRIPTION

- Round Type
- 5mm Diameter
- Lens Color: Water Clear
- With Flange
- Solder leads with standoffs

FEATURES

- Emitted Color: Blue
- High Luminous Intensity
- Viewing Angle: 15°

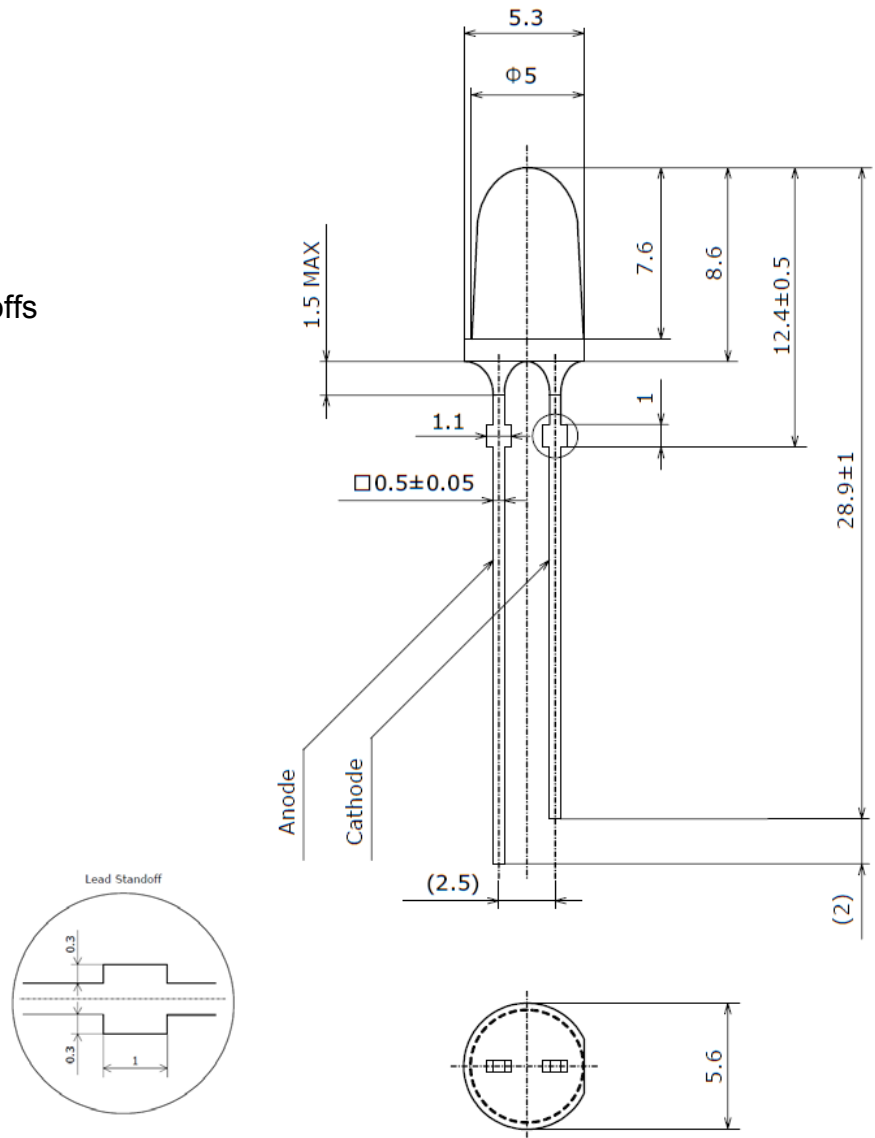

NOTES:

1. All dimensions are in millimeters tolerance is $\pm 0.25\text{mm}$ unless otherwise noted;

Part Number	Lens Color	
	Emitted	Lens
L513UBC-S	Blue	Water Clear



American Opto Plus LED Corp.

L513UBC-S

5mm Blue LED Lamp with Stand Off

ABSOLUTE MAXIMUM RATINGS

(Ta=25°C)

Parameter	Symbol	Ratings	Unit
DC Forward Current	I_F	35	mA
Peak Pulsed Forward Current	I_{FP}	110	mA
Reverse Voltage	V_R	5	V
Power Dissipation	P_d	123	mW
Operating temperature range	T_{opr}	-30~+85	°C
Storage temperature range	T_{stg}	-40~+100	°C
Junction Temperature	T_j	100	°C

OPTICAL-ELECTRICAL CHARACTERISTICS

(Ta=25°C)

Parameter	Symbol	Test Condition	Min	Typ	Max	Unit
Reverse Current	I_R	$V_R=5V$	--	--	50	μA
Forward Voltage	V_F	$I_F=20mA$	2.6	3.2	3.5	V
Luminous Intensity	I_v		4880	9750	13950	mcd
Dominant Wavelength			--	470	--	nm
Chromaticity Coordinate	x		--	0.133	--	--
Chromaticity Coordinate	y		--	0.075	--	--

*Note: I_{FP} = Pulse Width \leq 10ms, Duty Ratio \leq 1/10



American Opto Plus LED Corp.

L513UBC-S

5mm Blue LED Lamp with Stand Off

TYPICAL ELECTRICAL-OPTICAL CHARACTERISTIC CURVES

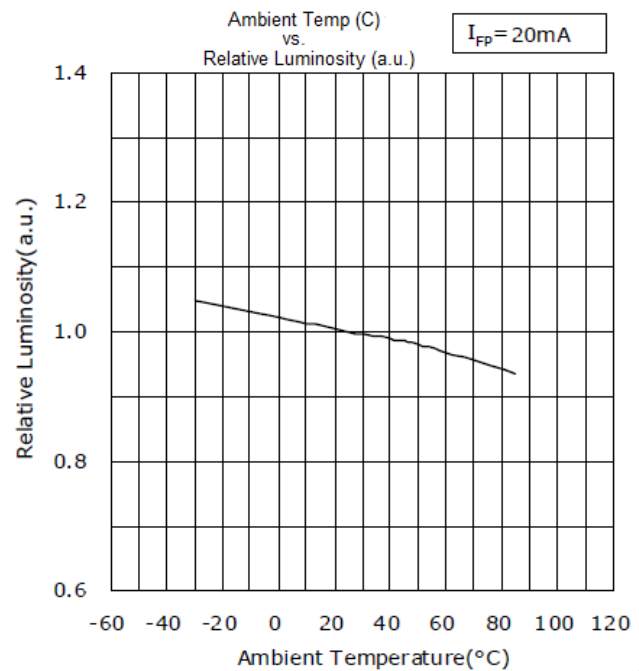
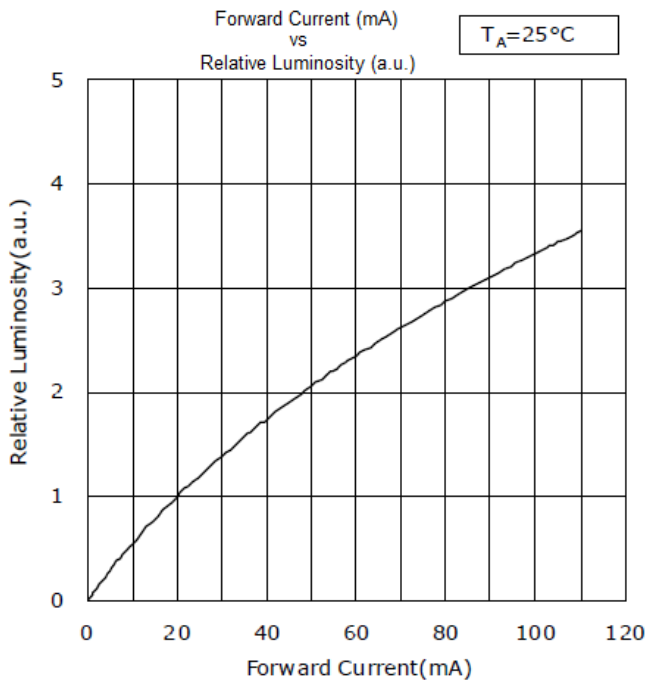
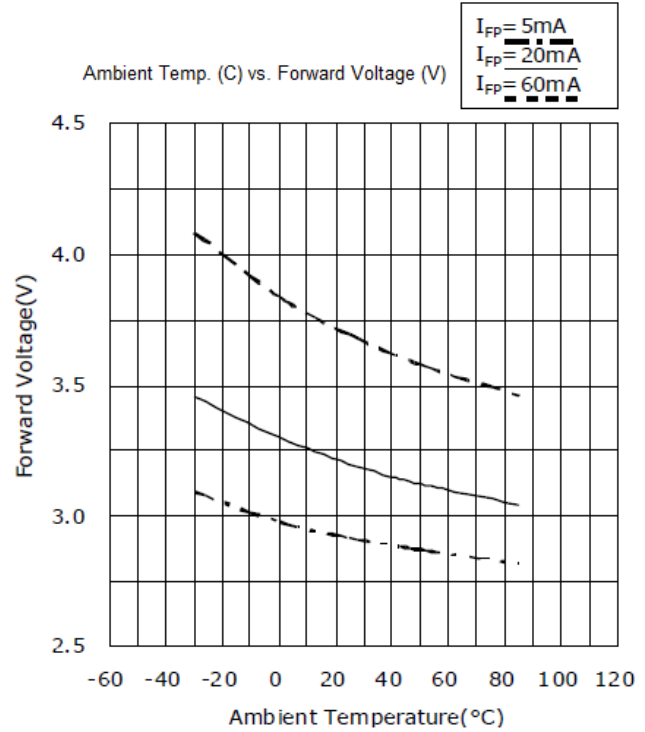
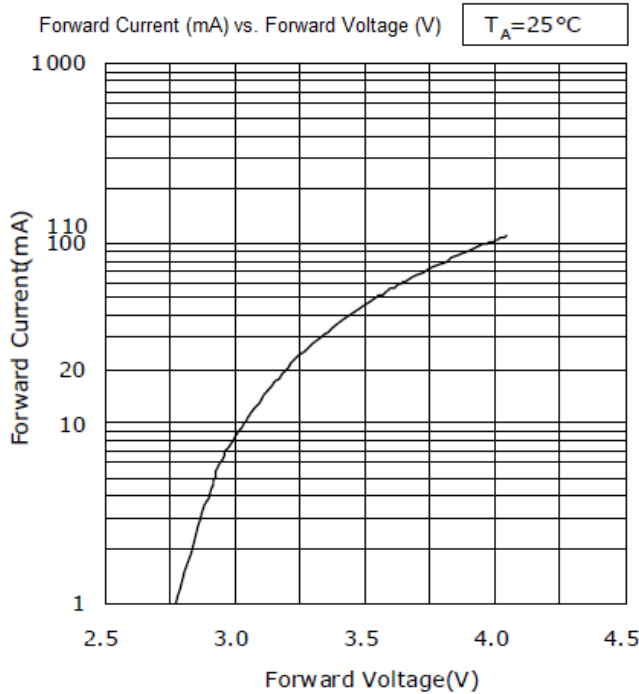



American Opto Plus LED Corp.

L513UBC-S

5mm Blue LED Lamp with Stand Off

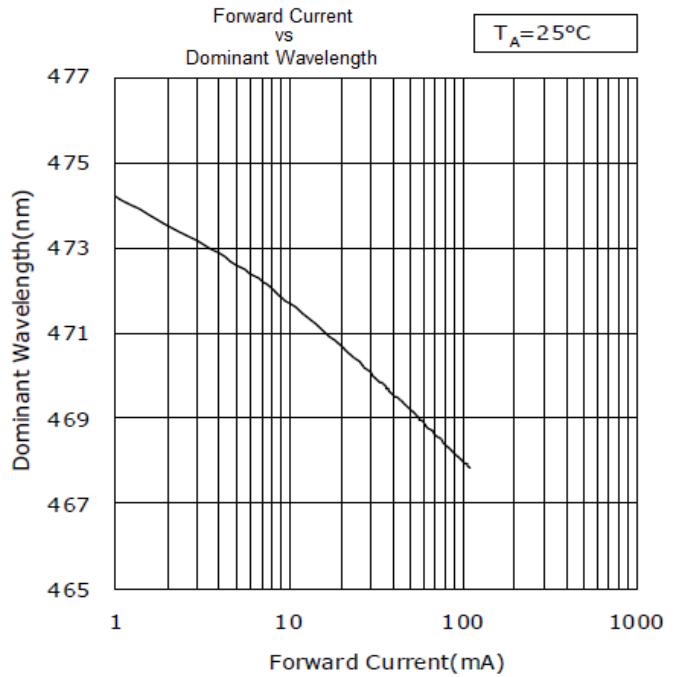
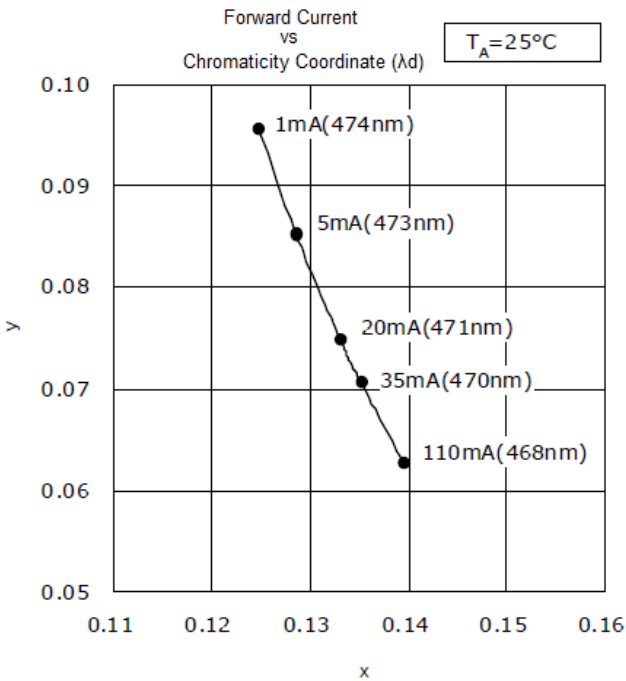
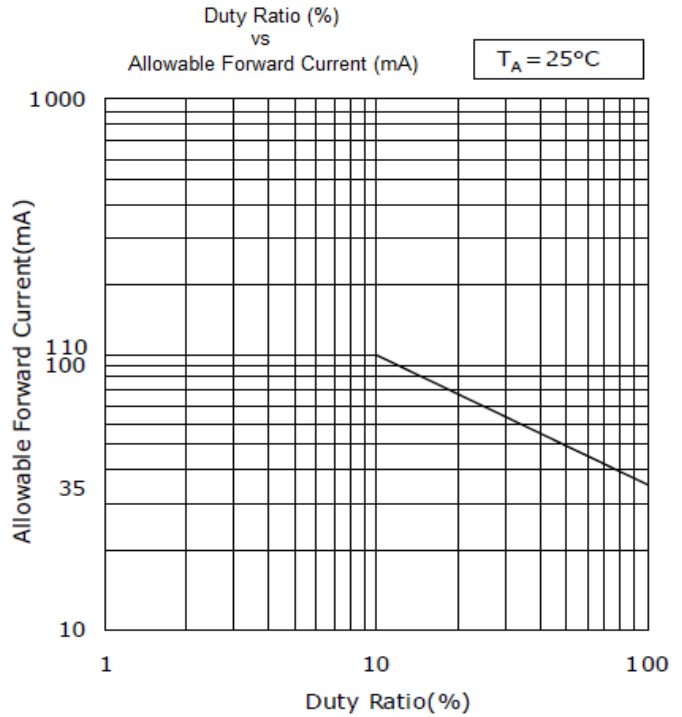
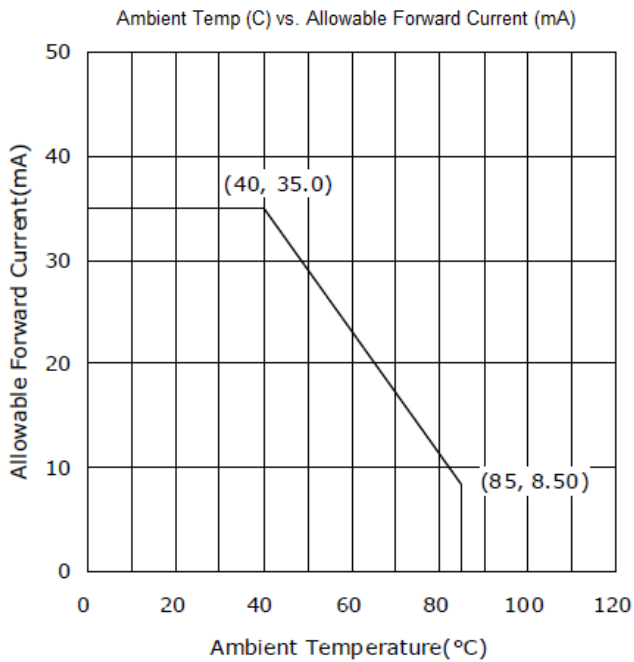



American Opto Plus LED Corp.

L513UBC-S

5mm Blue LED Lamp with Stand Off

SPECTRUM

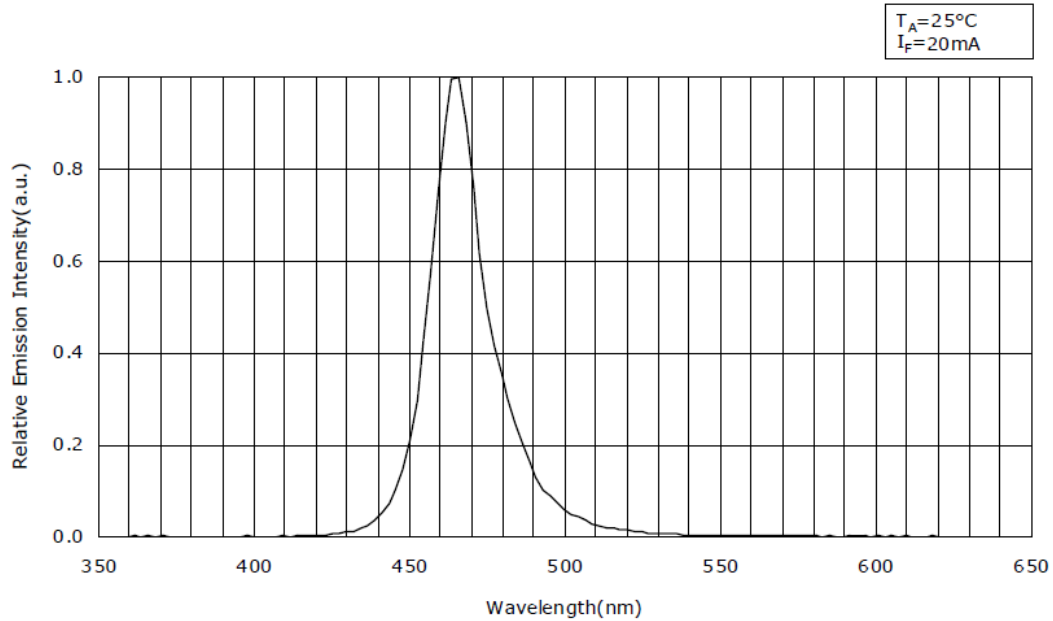

DIRECTIVITY RADIATION

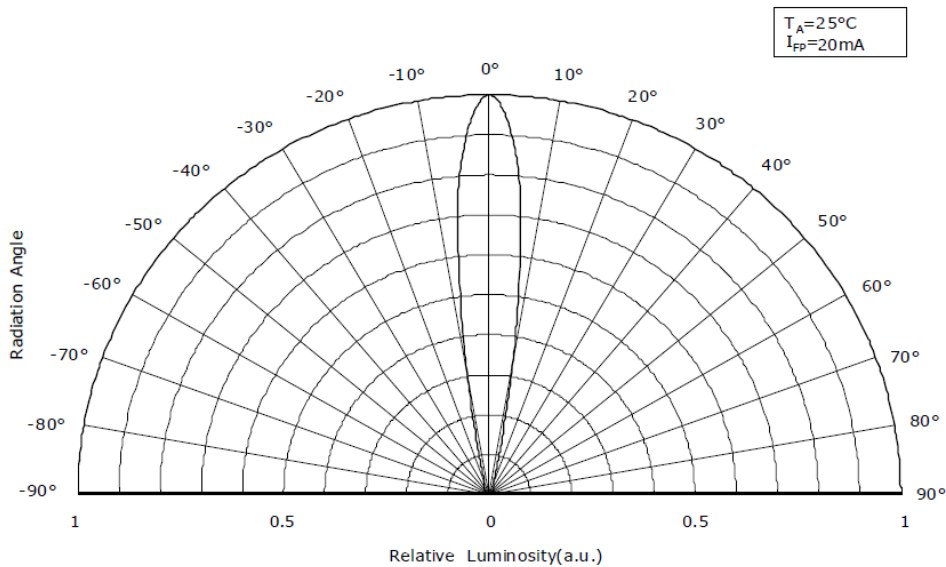



American Opto Plus LED Corp.

L513UBC-S

5mm Blue LED Lamp with Stand Off

CHROMATICITY DIAGRAM

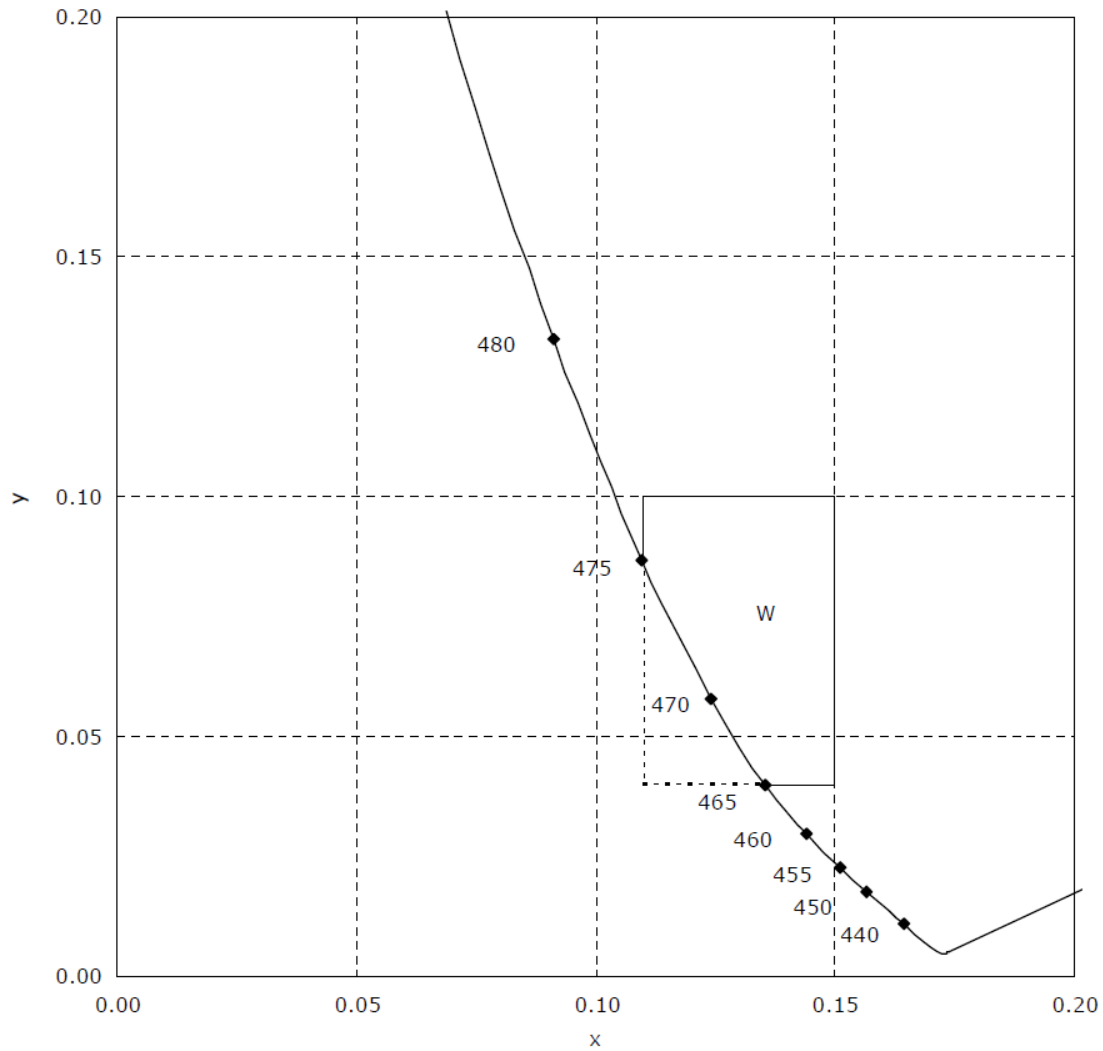

COLOR RANK

Rank W				
X	0.11	0.11	0.15	0.15
Y	0.04	0.10	0.10	0.04



American Opto Plus LED Corp.

L513UBC-S

5mm Blue LED Lamp with Stand Off

RELIABILITY

1) Tests and Results

Test	Reference Standard	Test Conditions	Test Duration	Failure Criteria #	Units Failed/Tested
Resistance to Soldering Heat	JEITA ED-4701 300 302	$T_{sld}=260\pm 5^{\circ}\text{C}$, 10sec, 1dip, 3mm from the base of the lens		#1	0/50
Solderability	JEITA ED-4701 303 303A	$T_{sld}=245\pm 5^{\circ}\text{C}$, 5sec, Lead-free Solder(Sn-3.0Ag-0.5Cu)		#2	0/50
Temperature Cycle	JEITA ED-4701 100 105	-40°C(30min)~25°C(5min)~100°C(30min)~25°C(5min)	100cycles	#1	0/50
Moisture Resistance (Cyclic)	JEITA ED-4701 200 203	25°C~65°C~-10°C, 90%RH, 24hr per cycle	10cycles	#1	0/50
Terminal Bend Strength	JEITA ED-4701 400 401	5N, 0°~90°~0°bend, 2bending cycles		#1	0/50
Terminal Pull Strength	JEITA ED-4701 400 401	10N, 10±1sec		#1	0/50
High Temperature Storage	JEITA ED-4701 200 201	$T_A=100^{\circ}\text{C}$	1000hours	#1	0/50
Temperature Humidity Storage	JEITA ED-4701 100 103	$T_A=60^{\circ}\text{C}$, RH=90%	1000hours	#1	0/50
Low Temperature Storage	JEITA ED-4701 200 202	$T_A=-40^{\circ}\text{C}$	1000hours	#1	0/50
Room Temperature Operating Life		$T_A=25^{\circ}\text{C}$, $I_F=35\text{mA}$	1000hours	#1	0/50
Temperature Humidity Operating Life		60°C, RH=90%, $I_F=20\text{mA}$	500hours	#1	0/50
Low Temperature Operating Life		$T_A=-30^{\circ}\text{C}$, $I_F=20\text{mA}$	1000hours	#1	0/50

Note: Measurements are performed after allowing the LEDs to return to room temperature.

2) Failure Criteria

Criteria #	Items	Conditions	Failure Criteria
#1	Forward Voltage(V_F)	$I_F=20\text{mA}$	>U.S.L. x 1.1
	Luminous Intensity(I_V)	$I_F=20\text{mA}$	<L.S.L. x 0.7
	Reverse Current(I_R)	$V_R=5\text{V}$	>U.S.L. x 2.0
#2	Solderability	-	Less than 95% solder coverage

U.S.L. : Upper Specification Limit L.S.L. : Lower Specification Limit



American Opto Plus LED Corp.

L513UBC-S

5mm Blue LED Lamp with Stand Off

SOLDERING CONDITIONS – LAMP TYPE LED

- Solder the LED no closer than 3mm from the base of the epoxy bulb. Soldering beyond the base of the tie bar is recommended.
- Recommended soldering conditions.

Dip Soldering

Pre-Heat	100°C Max.
Pre-Heat Time	60 sec. Max.
Solder Bath Temperature	260°C Max.
Dipping Time	5 sec. Max.
Dipping Position	No lower than 3mm from the base of the epoxy bulb.

Hand Soldering

	30 Series	Others (Including Lead-Free Solder)
Temperature	300°C Max.	350°C Max.
Soldering time	3 sec. Max.	3 sec. Max.
Position	No closer than 3mm from the base of the epoxy bulb.	No closer than 3mm from the base of the epoxy bulb.

- Do not apply any stress to the lead, particularly when heated
- The LEDs must not be repositioned after soldering
- After soldering the LEDs, the epoxy bulb should be protected from mechanical shock or vibration until the LEDs return to room temperature.
- Direct soldering onto a PC board should be avoided. Mechanical stress to the resin may be caused by the PC board warping or from the clinching and cutting of the leadframes. When it is absolutely necessary, the LEDs may be mounted in this fashion, but the User will assume responsibility for any problems. Direct soldering should only be done after testing has confirmed that no damage, such as wire bond failure or resin deterioration, will occur. AOP's LEDs should not be soldered directly to double sided PC boards because the heat will deteriorate the epoxy resin.
- When it is necessary to clamp the LEDs to prevent soldering failure, it is important to minimize the mechanical stress on the LEDs.
- Cut the LED leadframes at room temperature. Cutting the leadframes at high temperatures may cause LED failure.