

Industrial PT-1000 Temperature Probe

Reads **Temperature**

Probe type **Class A platinum, RTD**

Range **-55°C to 220 °C**

Accuracy **+/- (0.15 + (0.002*t))**

Reaction Time **90% in 13s**

Cable length **3 Meters**

Connector **Tinned leads**

Output **Resistance (Analog)**

Life expectancy **15 years**

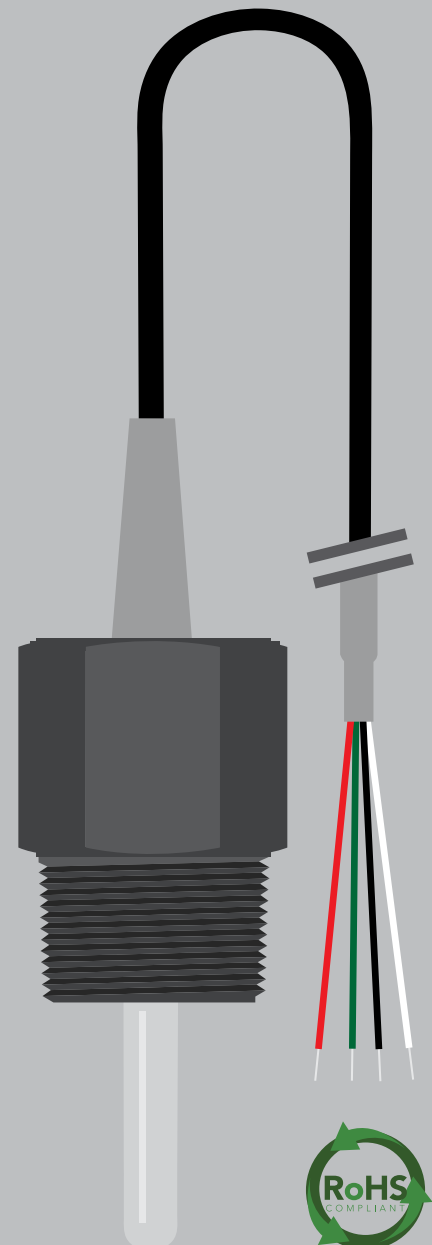

Measurements

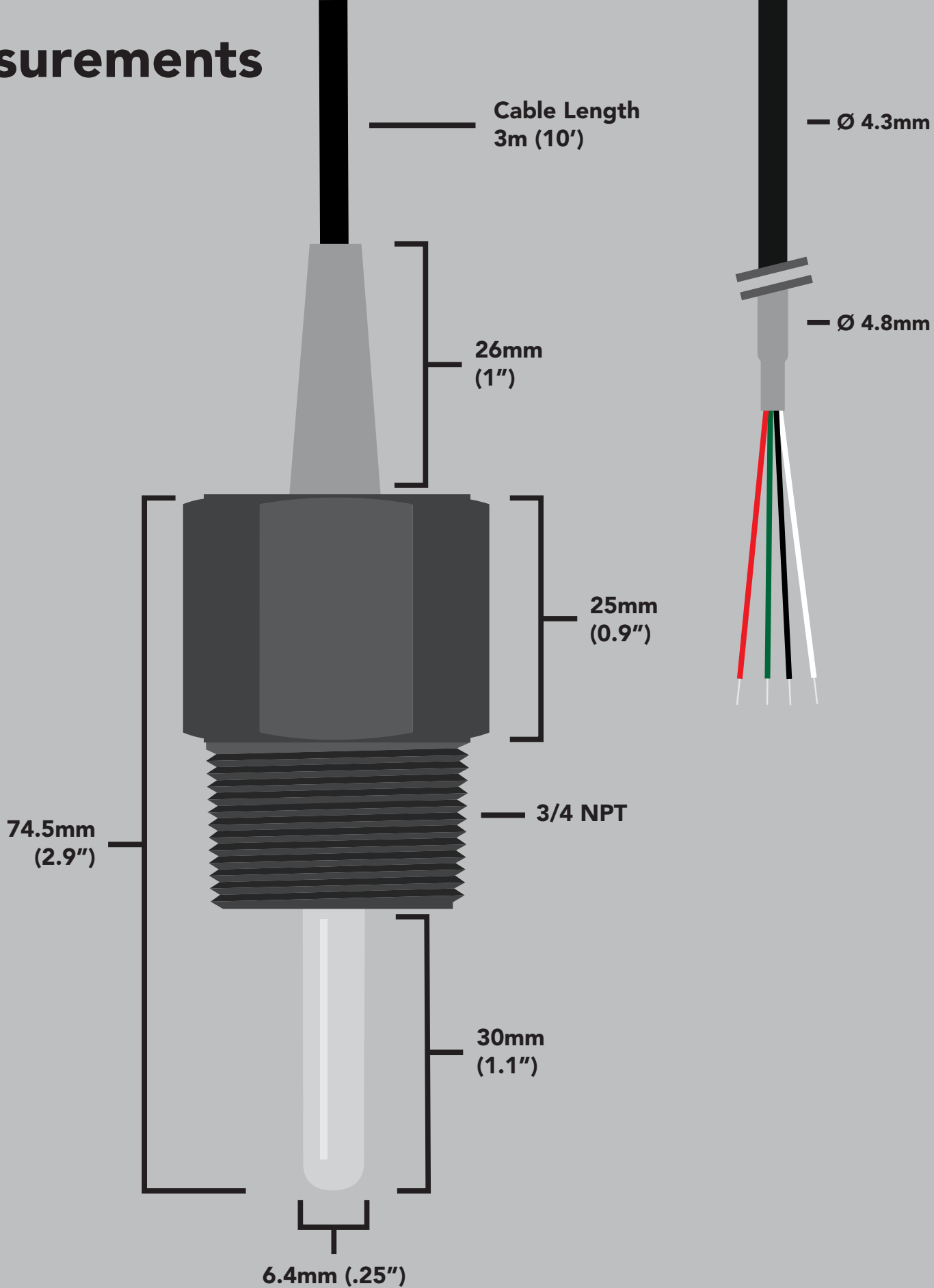

Wiring guide

This four wire PT-1000 probe can be connected to any device that can read a two, three or four wire PT-1000 temperature probe.

A PT-1000 temperature probe converts the resistance of platinum to temperature.

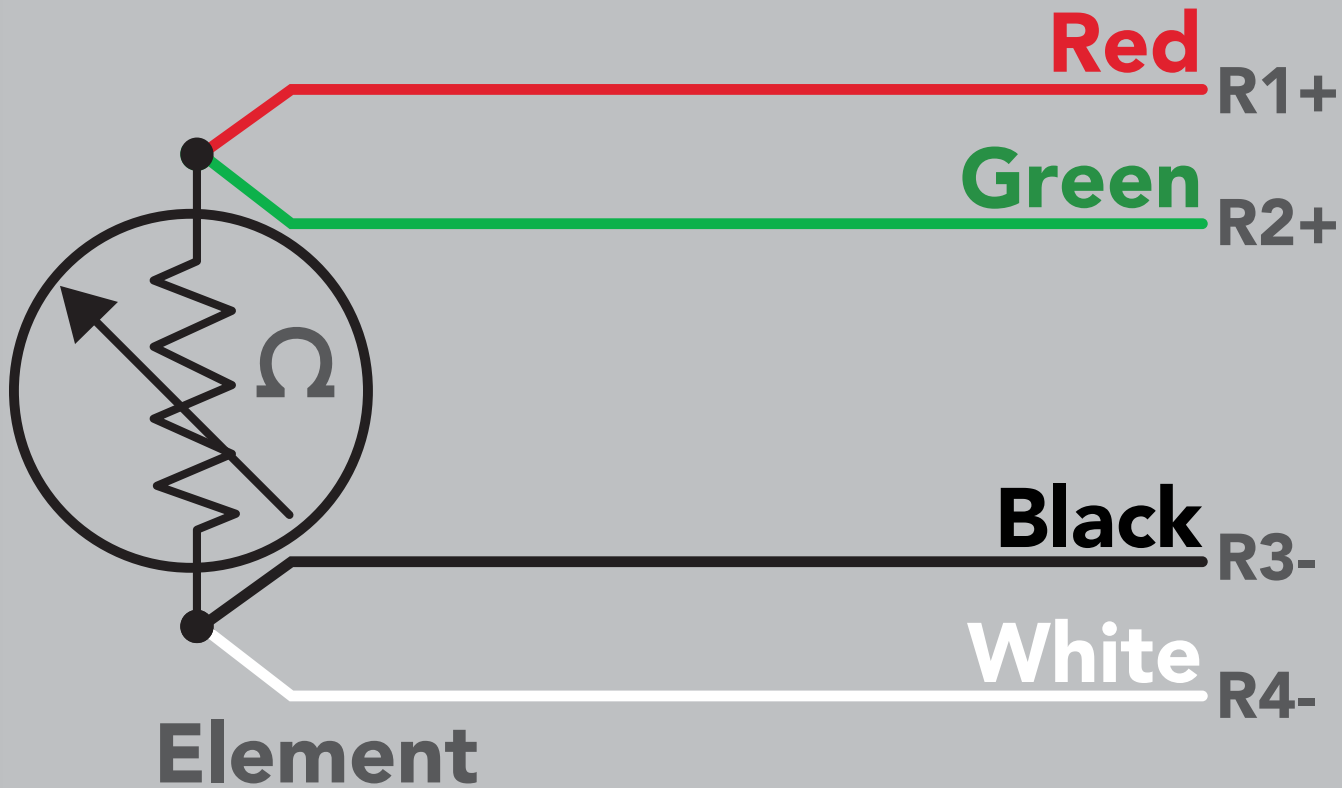

Two wire connection

Three wire connection

Four wire connection

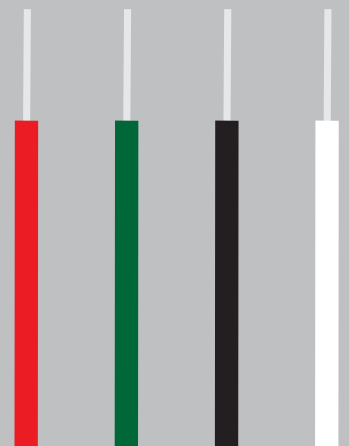
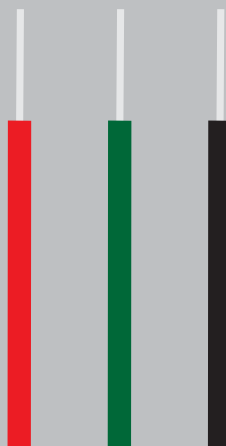

Specifications

Cable length	3m (10 feet)
Weight	140 grams
Max cable temp	125°C
Sensing material	Platinum
Threading	(3/4") NPT
Tinned leads	Yes
Sterilization	Chemical / Autoclave
Food safe	Yes

Materials

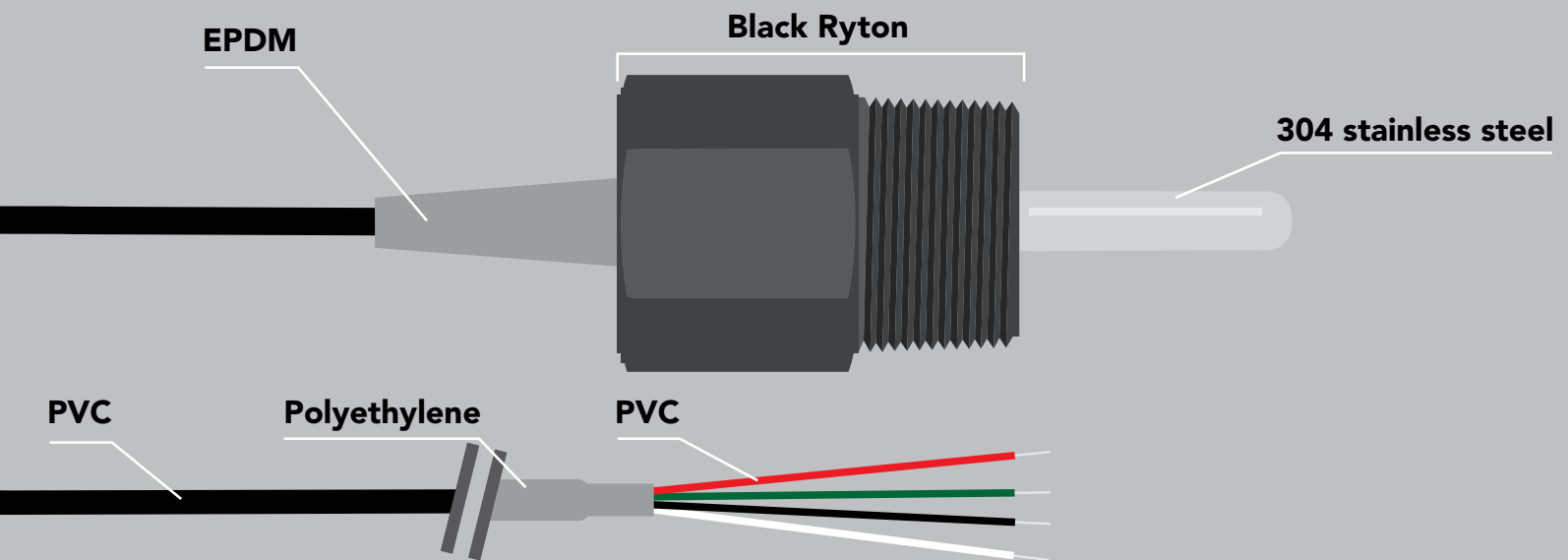

This PT-1000 probe can be **fully submerged** in fresh or salt water, up to the Tinned leads **indefinitely**.

Typical Applications

- Temperature measurement of a liquid oil or gas

NSF/ANSI 51 Compliant

Food Safe

Atlas Scientific LLC, hereby certifies that,

Industrial PT-100 Temperature Probe
Part # *ENV-50-TMP*

Complies with NSF/ANSI Standard 51

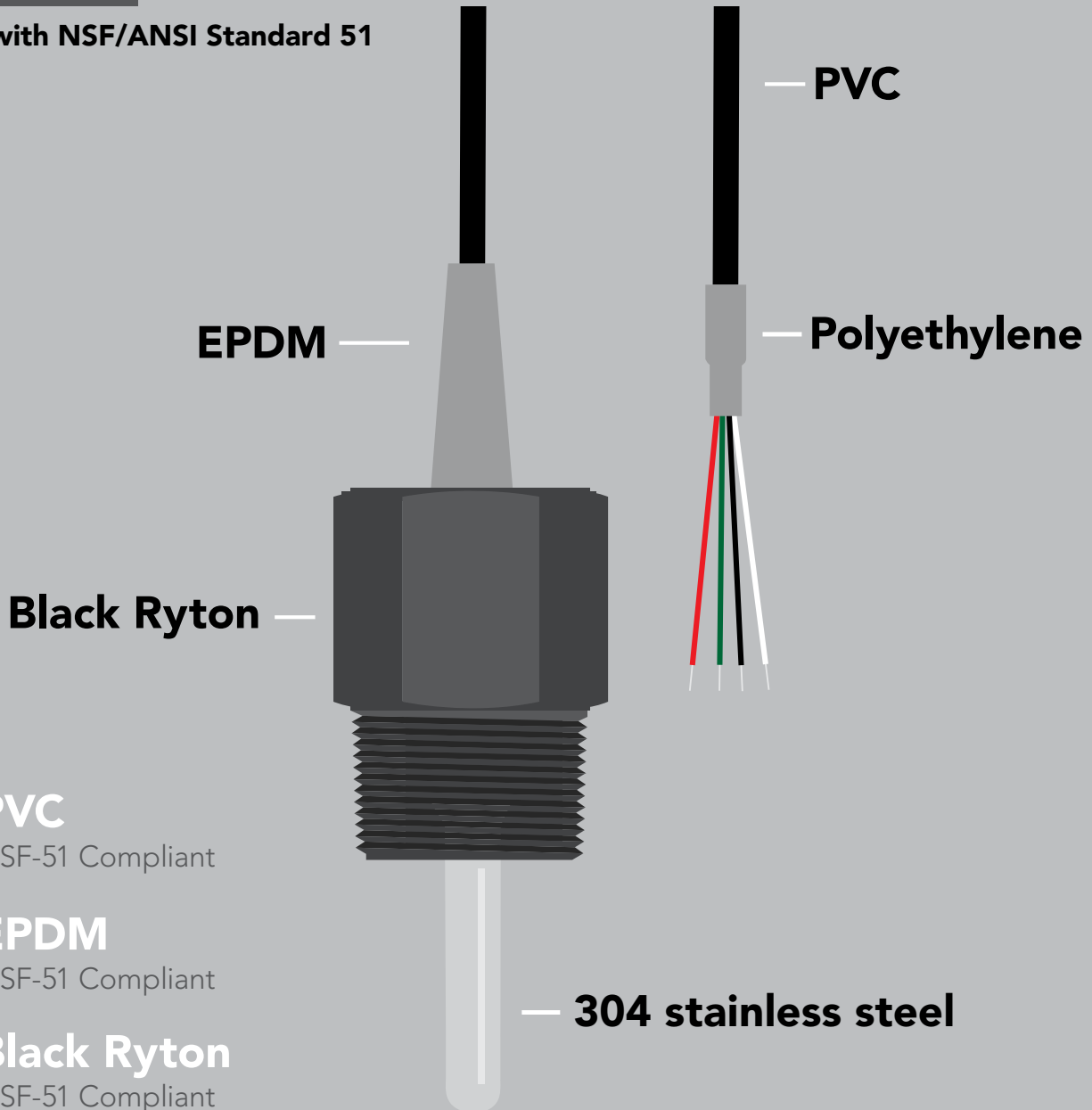

PVC

NSF-51 Compliant



EPDM

NSF-51 Compliant



Black Ryton

NSF-51 Compliant



Polyethylene

NSF-51 Compliant



304 stainless steel

NSF-51 Compliant

Operating principle

Unlike any other material, platinum's correlation between resistance and temperature seems to be woven into the fabric of the universe. It is for this reason, that the platinum RTD temperature sensor is the industrial standard for temperature measurement.

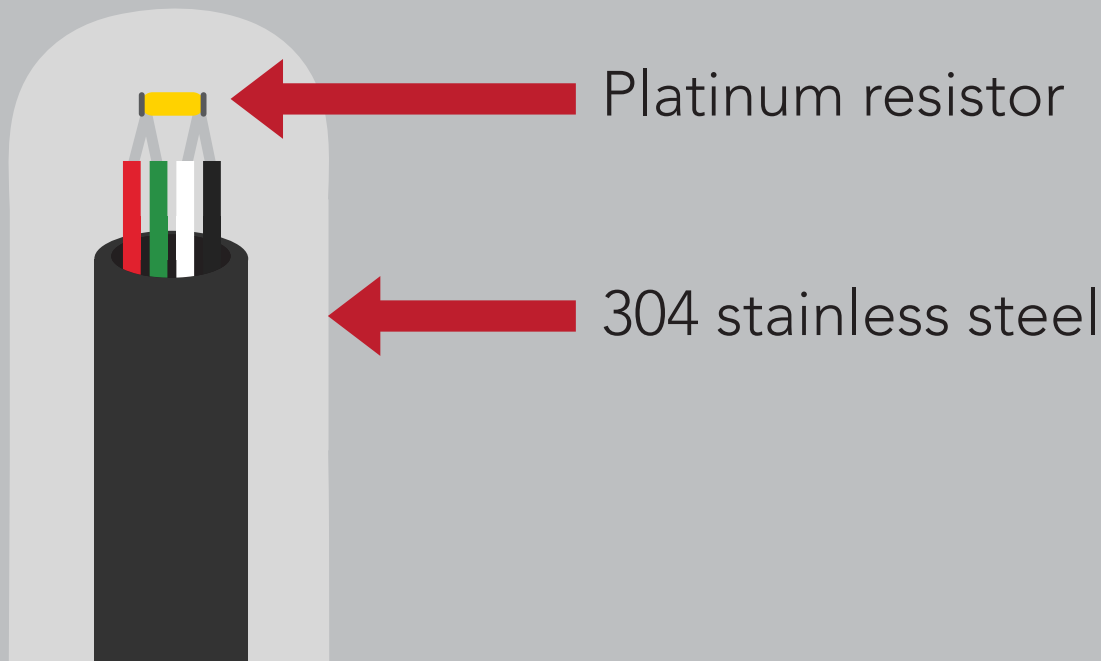
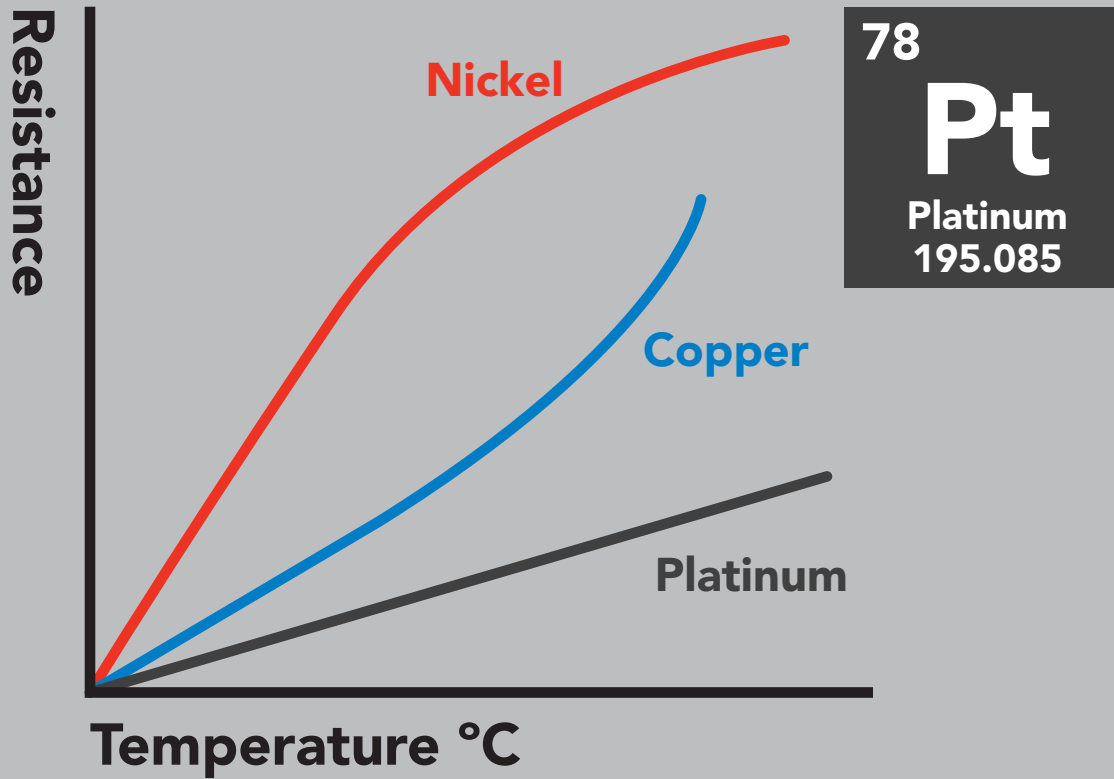

The PT-1000 temperature probe is a resistance type thermometer. Where PT stands for platinum and 1000 is the measured resistance of the probe at 0°C in ohms (1k at 0°C). As the temperature changes the resistance of the platinum changes.

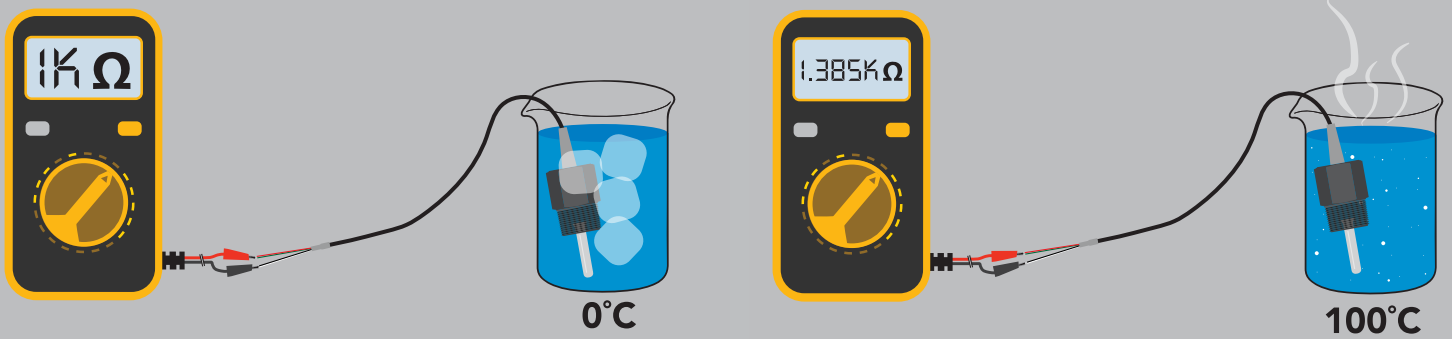

To convert the resistance of the probe to temperature, use the following simplified equation:

$$T = - \frac{\sqrt{(-0.00232(R) + 17.59246)} - 3.908}{0.00116}$$

T = Degrees Celsius
R = Resistance measured from PT-1000 temperature probe

Below is a small table of temperatures and resistances, to help insure the above equation has been properly embedded into your code.

°C	Ω	°C	Ω	°C	Ω
-10	= 960.9	7	= 1027.3	24	= 1093.5
-9	= 964.8	8	= 1031.2	25	= 1097.3
-8	= 968.7	9	= 1035.1	26	= 1101.2
-7	= 972.6	10	= 1039	27	= 1105.1
-6	= 976.5	11	= 1042.9	28	= 1109
-5	= 980.4	12	= 1046.8	29	= 1112.8
-4	= 984.4	13	= 1050.7	30	= 1116.7
-3	= 988.3	14	= 1054.6	31	= 1120.6
-2	= 992.2	15	= 1058.5	32	= 1124.5
-1	= 996.1	16	= 1062.4	33	= 1128.3
0	= 1000	17	= 1066.3	34	= 1132.2
1	= 1003.9	18	= 1070.2	35	= 1136.1
2	= 1007.8	19	= 1074	36	= 1139.9
3	= 1011.7	20	= 1077.9	37	= 1143.8
4	= 1015.6	21	= 1081.8	38	= 1147.7
5	= 1019.5	22	= 1085.7	39	= 1151.5
6	= 1023.4	23	= 1089.6	40	= 1155.4

How to connect the Industrial PT-1000 Temperature probe

The Atlas Scientific™ Industrial PT-1000 temperature probe can be connected in several different ways. The following show two examples:

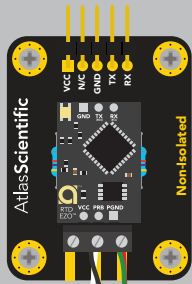

Using the terminal block option on our non-isolated EZO™ Carrier Board, you can easily connect the Industrial PT-1000 Temperature probe to our **EZO™ RTD Circuit**.

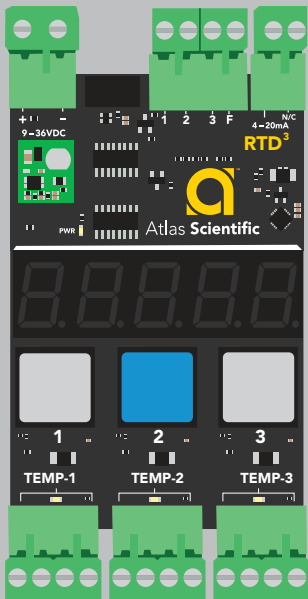
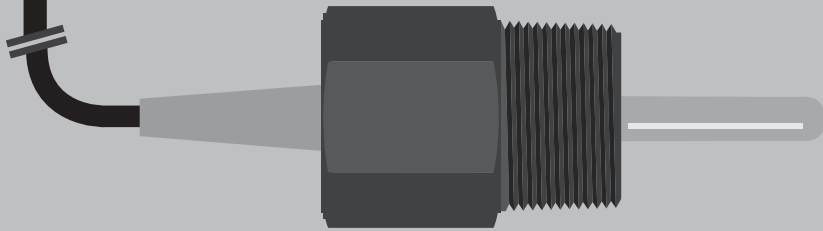

For industrial purposes, the Industrial PT-1000 Temperature probe connects easily to our **Industrial RTD Transmitter**.

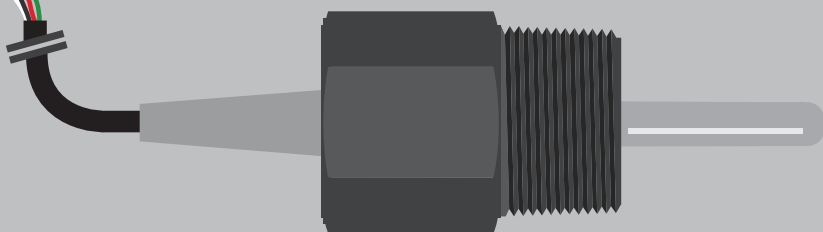

Probe cleaning

Over time PT-1000 probes can become dirty and covered in deposits. Both soft and hard coatings can be removed by lightly brushing around the sensing area.

