

EPIC® SIGNAL M23

Rugged nickel-plated zinc connectors for power applications



Approvals



Application advantage

- Rugged nickel-plated, die-cast zinc body
- Positive vibration protection for use with motor drives and moving assemblies
- Integral EMC cable gland provides strain relief, IP67/68 protection, and 360° shielding
- Coding rings ensure correct mating selection in multiple connector installations

EPIC® SIGNAL M23 connectors are available in 11 housing styles that can accommodate 3 different insert keying positions. Inserts are offered in 7 contact configurations for mounting male or female, crimp, or solder contacts. Common to all arrangements are a rugged nickel-plated zinc body, plastic contact insulation body and sleeve, and gold-plated electrical contacts. Cable mounted arrangements also include an integral EMC shield ring and cable clamp and seal. The figure above shows the general construction of these connectors.

The connectors are offered with insert configurations for 6, 7, 8+1, 9, 12, 16 & 17 crimp or solder contacts in either a clockwise or counter-clockwise orientation. Used in combination, they connect one cable to another (cable coupler) or a cable to fixed wiring in a control enclosure or on a machine, instrument, encoder or servo motor.









Technical data

Number of contacts:	6, 7, 8+1, 9, 12, 16, 17	Wire gauge:	
Temperature range:	-25°C to +125°C	- crimp termination:	
Rated voltage:		- 1 mm contacts:	26 - 18 AWG (0.14 - 1.0 mm ²)
- 6, 7, 8+1 & 9 poles:	150V	- 2 mm contacts:	18 - 14 AWG (1.0 - 2.5 mm ²)
- 12 & 16 poles:	100V	- solder termination:	
- 17 poles:	50V	- 1 mm contacts:	up to 18 AWG (1.0 mm ²)
Rated current:		- 2 mm contacts:	up to 14 AWG (2.5 mm ²)
- 6 & 7 poles:	14A	Cable diameter:	7.0 - 13.5 mm
- 8+1, 9, 12, 16 & 17 poles:	7A	Mating cycles:	100 minimum
Impulse voltage:		Material:	
- 6 & 7 poles:	4kV	- housing:	nickel-plated die-cast zinc
- 8+1 poles:	2.5kV	- style C2:	nickel-plated copper alloy
- 9, 12 & 16 poles:	1.5kV	- insulation body:	PA, PBT, V-0 per UL 94
- 17 poles:	0.8kV	- contacts:	gold-plated copper alloy
Protection class:		- gaskets & seals:	FPM
- style A3:	IP67/68 (10h/1m) IP65	Contact resistance:	< 4 mΩ
		Approvals:	DIN EN 61984 cRUus #E75770

EPIC® SIGNAL M23 inserts



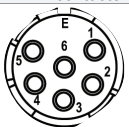

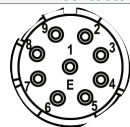
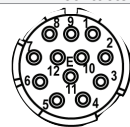
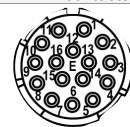
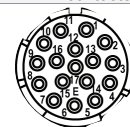



Connector inserts will accept both male and female contacts. A complete connection requires one E-type insert and one P-type insert.

E-type inserts

Description	6 contacts	7 contacts	8+1 contacts	9 contacts	12 contacts	16 contacts	17 contacts
without contacts	73002766	44420154	73002742	73002730	73002718	73002706	73008500
with male solder contacts	73002768	44420156	73002744	73002732	73002720	73002708	73028500
with female solder contacts	73002770	44420158	73002746	73002734	73002722	73002710	73018500
insert configurations	 2 mm contacts	 2 mm contacts	 1 & 2 mm contacts	 1 mm contacts	 1 mm contacts	 1 mm contacts	 1 mm contacts
							
clockwise numbered contacts viewed from the mating side							

12 & 17 pole inserts for PCB soldering are available on request (non-stock)

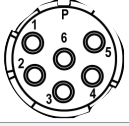
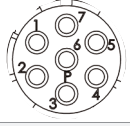
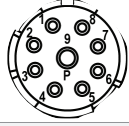
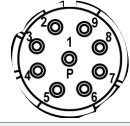
P-type inserts

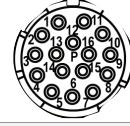
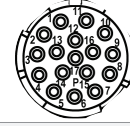
Description	6 contacts	7 contacts	8+1 contacts	9 contacts	12 contacts	16 contacts	17 contacts
without contacts	73002760	44420148	73002736	73002724	73002712	73002700	73008000
with male solder contacts	73002762	44420150	73002738	73002726	73002714	73002702	73028000
with female solder contacts	73002764	44420152	73002740	73002728	73002716	73002704	73018000
insert configurations	 2 mm contacts	 2 mm contacts	 1 & 2 mm contacts	 1 mm contacts	 1 mm contacts	 1 mm contacts	 1 mm contacts
							
counter-clockwise numbered contacts viewed from the mating side							

12 & 17 pole inserts for PCB soldering are available on request (non-stock)

EPIC® SIGNAL M23 contacts

Size AWG	mm ²	Description	Termination type	Part number
1 mm contacts				
26 - 18	0.14 - 1.0	gold male contacts	crimp	72400000
26 - 18	0.14 - 1.0	gold female contacts	crimp	74200600
26 - 18	0.14 - 1.0	HYP gold female contacts	crimp	74034500
up to 18	up to 1.0	gold male contacts	solder	72402000
up to 18	up to 1.0	gold female contacts	solder	72402600

Size AWG	mm ²	Description	Termination type	Part number
2 mm contacts				
18 - 14	1.0 - 2.5	gold male contacts	crimp	72401000
18 - 14	1.0 - 2.5	gold female contacts	crimp	72401600
up to 14	up to 2.5	gold male contacts	solder	72403000
up to 14	up to 2.5	gold female contacts	solder	72404000

EPIC® SIGNAL M23 style A1 Straight panel mount base

keying: N



keying: -20°



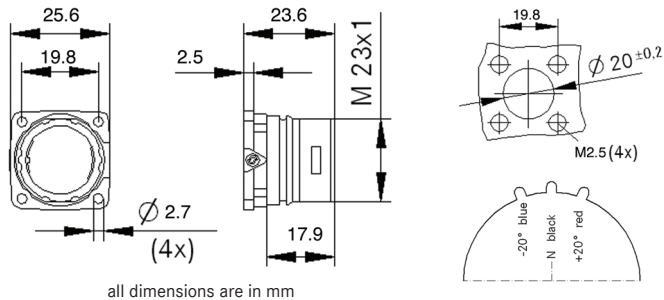
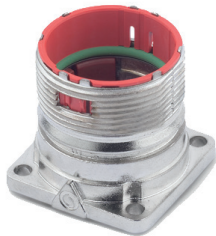

keying: +20°



Keying	Part number
N	72004000
-20°	72004100
+20°	72004200

Contact tools

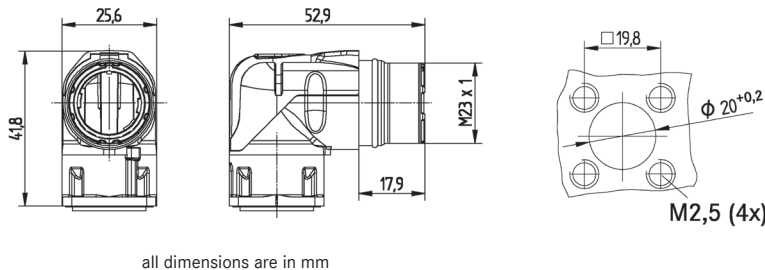

 Crimp tool: 11148000	 Locator: 11148300	 Removal tool: 44420078
---	---	---

EPIC® SIGNAL M23 style A3 Angled panel mount base



Part number
24420055

Contact tools

 Crimp tool: 11148000	 Locator: 11148300	 Removal tool: 44420078
---	---	---

EPIC® SIGNAL M23 style D6 Cable connector

keying: N



keying: -20°



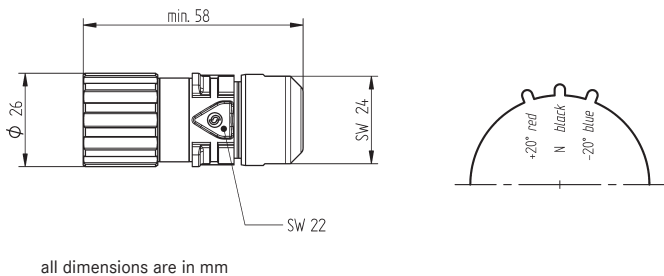

keying: +20°



Keying	Part number
N	44420037
-20°	44420036
+20°	44420038

Contact tools

 Crimp tool: 11148000	 Locator: 11148300
---	---

If not otherwise specified, all values relating to the product are nominal values. Photographs are not to scale and are not true representations of the products in question.

SIGNAL M23

Circular connectors

EPIC® SIGNAL M23 style F6

Cable coupler

keying: N

keying: -20°

keying: +20°

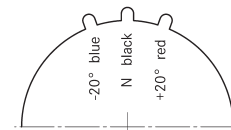
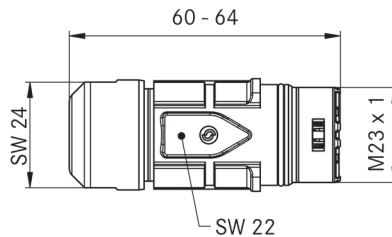

all dimensions are in mm

Keying	Part number
N	44420040
-20°	44420039
+20°	44420041

Contact tools



Crimp tool:
11148000



Locator:
11148300

EPIC® SIGNAL M23 style F7

Cable coupler with flange

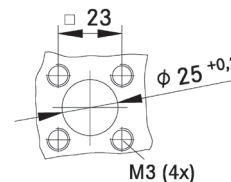
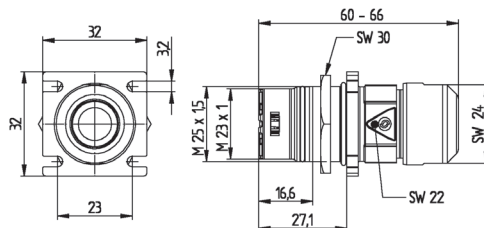

all dimensions are in mm

Max. cable outer diameter	Part number
7 - 10 mm	44420009
9.5 - 13.5 mm	44420011

Contact tools



Crimp tool:
11148000



Locator:
11148300

EPIC® SIGNAL M23 style G5

Front wall mounting with locknut or M25 x 1.5 thread mount

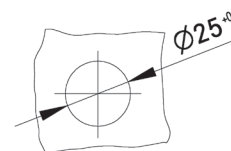
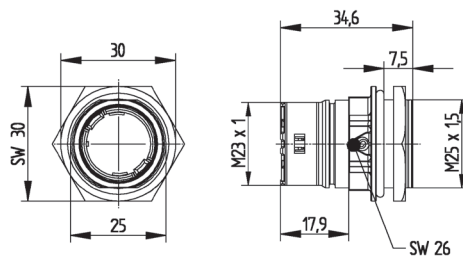

all dimensions are in mm

Keying	Part number
N	44420046
-20°	44420044
+20°	44420048

Contact tools



Crimp tool:
11148000



Locator:
11148300



Removal tool:
44420078

If not otherwise specified, all values relating to the product are nominal values. Photographs are not to scale and are not true representations of the products in question.

EPIC® SIGNAL M23 style G6

Rear wall mounting

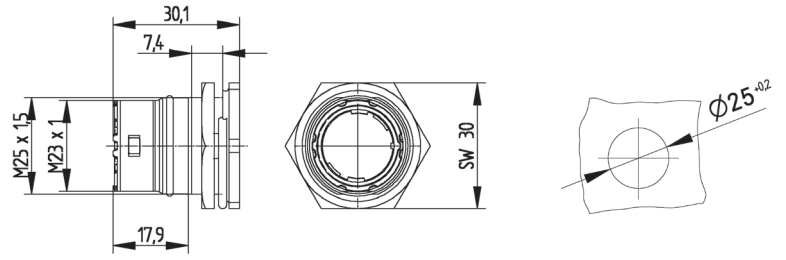

all dimensions are in mm

Part number
44420071

Contact tools



Crimp tool:
11148000



Locator:
11148300



Removal tool:
44420078

EPIC® SIGNAL M23 style B1

Rear wall mounting

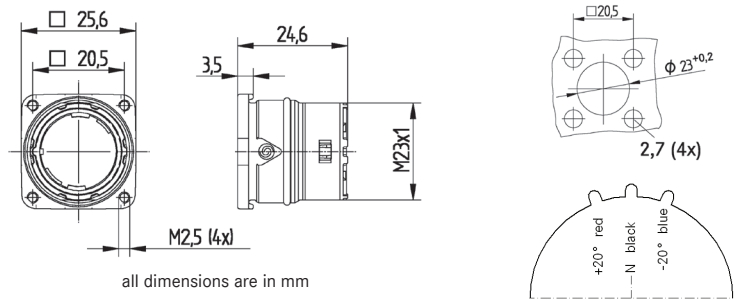

all dimensions are in mm

Keying	Part number
N	44420024
-20°	44420022
+20°	44420026

Contact tools



Crimp tool:
11148000



Locator:
11148300



Removal tool:
44420078

EPIC® SIGNAL M23 style B2

Rear wall mounting

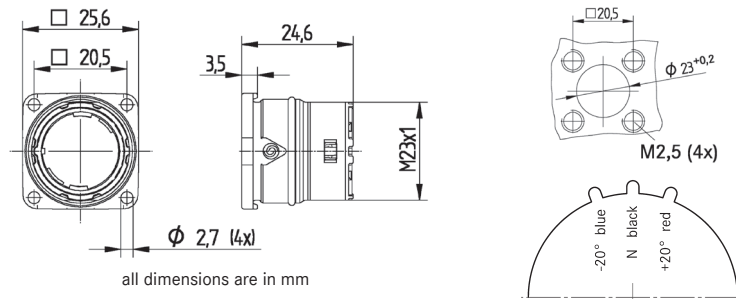

all dimensions are in mm

Keying	Part number
N	44420050
-20°	44420052
+20°	44420035

Contact tools



Crimp tool:
11148000



Locator:
11148300



Removal tool:
44420078

If not otherwise specified, all values relating to the product are nominal values. Photographs are not to scale and are not true representations of the products in question.

EPIC® SIGNAL M23 style C2

Panel mount feed-through

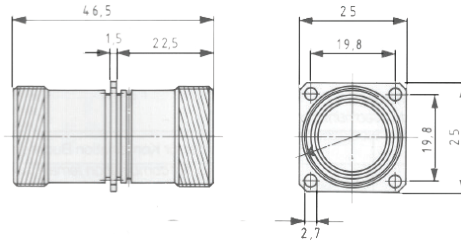

all dimensions are in mm

Number of contacts	Part number
12	00010108
17	00010521

Contact tools



Crimp tool:
11148000



Locator:
11148300



Removal tool:
44420078

EPIC® SIGNAL M23 accessories & tools

metal screw cap



Style 1

Style 2

plastic protection cap



SILVYN® adapter



removal tool



Style	Connector Style	Part number
1	A, F6, G	75018110
2	A, B, F7, O	75018010

Size	Part number
D6	75007710
A, B, F, G, O	75007810

Adapter allows connection to jacketed cable run in SILVYN® conduit.

Size	Part number
M20 x 1.5	55001312

Part number
44420078

If not otherwise specified, all values relating to the product are nominal values. Photographs are not to scale and are not true representations of the products in question.