

ALS31A152KE250

Aliases (A431LH152M250A)

ALS31, Aluminum Electrolytic, 1,500 uF, 20%, 250 VDC, -40/+85°C

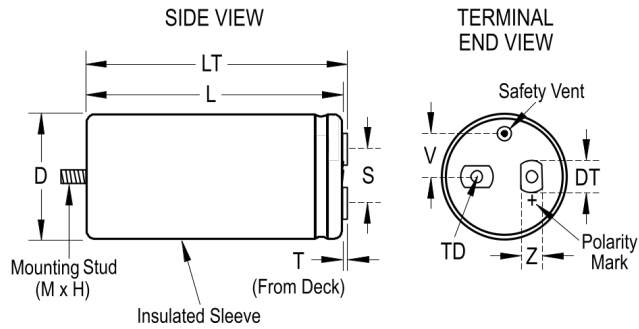

Click [here](#) for the 3D model.

Dimensions

D	51mm +/-1mm
L	82mm +/-2mm
T	5.5mm +/-0.5mm
S	22.2mm +/-0.5mm
DT	13mm +/-0.5mm
LT	86.5mm +/-1mm
TD	10mm MIN
V	13.7mm NOM
Z	10mm NOM

Packaging Specifications

Sleeving	Yes
Packaging	Bulk, Box

General Information

Series	ALS31
Dielectric	Aluminum Electrolytic
Description	Screw Terminal, Aluminum Electrolytic
RoHS	Yes
AEC-Q200	No
Component Weight	220 g
Notes	Dimensions D And L Include Sleeving. MS (MxH) = M12x16.
Shelf Life	156 Weeks

Specifications

Capacitance	1,500 uF
Capacitance Tolerance	20%
Voltage DC	250 VDC, 288 VDC (Surge)
Temperature Range	-40/+85°C
Rated Temperature	85°C
Life	18000 Hrs (Rated Voltage And Ripple Current At 85C), 36000 Hrs (Rated Voltage At 85C)
Resistance	86 mOhms (100Hz 20C), 67 mOhms (10kHz 20C)
Ripple Current	6.2 Amps (100Hz 85C), 9.8 Amps (10kHz 85C)
Leakage Current	2250 uA (5min 20°C)