

**TORQUE SETTING**

6.1-9.5 in-lbs [7-11 kgf-cm]

**MATERIAL & FINISH**

BACKSHELL: ABS - UL HB RATED - BLACK  
 BUSHING & BAFFLE: SILICONE  
 THUMBSCREWS: NICKEL PLATED BRASS  
 OPERATION TEMPERATURE: 0°C TO 80°C (BASED ON ABS)  
 CABLE DIAMETER: 0.300 in [7.62mm] MAX  
 0.100 in [2.54mm] MIN

**MATING PANEL:**

\*INTENDED TO MATE TO REAR PANEL MOUNTED DSUB  
 RECOMMENDED MAX PANEL THICKNESS: 0.065"  
 RECOMMENDED MIN PANEL THICKNESS: 0.040"

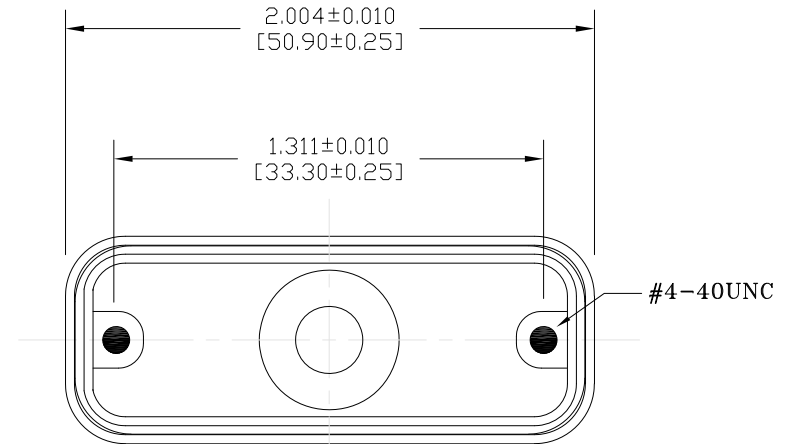

RoHS COMPLIANT

UNITS = inch [mm]

DO NOT SCALE FROM DRAWING



THESE DRAWINGS AND SPECIFICATIONS ARE THE PROPERTY OF NorComp AND SHALL NOT BE REPRODUCED, COPIED OR USED AS THE BASIS FOR THE MANUFACTURE OR SALE OF APPARATUS WITHOUT WRITTEN PERMISSION.

DRAWN:  
M. SIGMON

DATE:  
12/15/2010

NorComp

SCALE:  
NTS

SHEET OF  
1 1

REV  
7

DWG NO.

967-015-010R011