



GRL18SG-F2337

GR18S

CYLINDRICAL PHOTOELECTRIC SENSORS

SICK
Sensor Intelligence.



Ordering information

Type	Part no.
GRL18SG-F2337	1059553

Other models and accessories → www.sick.com/GR18S

Illustration may differ



Detailed technical data

Features

Sensor/ detection principle	Photoelectric retro-reflective sensor, Dual lens
Housing design (light emission)	Cylindrical
Thread diameter (housing)	M18 x 1
Optical axis	Axial
Sensing range max.	0.03 m ... 7.2 m ¹⁾
Sensing range	0.06 m ... 6 m ¹⁾
Type of light	Visible red light
Light source	PinPoint LED ²⁾
Light spot size (distance)	Ø 175 mm (7 m)
Wave length	650 nm
Adjustment	Potentiometer, 270°
Special applications	Detecting transparent objects

¹⁾ Reflector PL80A.

²⁾ Average service life: 100,000 h at T_U = +25 °C.

Mechanics/electronics

Supply voltage	10 V DC ... 30 V DC ¹⁾
Ripple	± 5 V _{pp} ²⁾

¹⁾ Limit values. Operated in short-circuit protected network: max. 8 A.

²⁾ May not exceed or fall below U_v tolerances.

³⁾ At U_v > 24 V or ambient temperature > 49 °C, I_A max. = 50 mA.

⁴⁾ Signal transit time with resistive load.

⁵⁾ With light/dark ratio 1:1.

⁶⁾ A = V_S connections reverse-polarity protected.

⁷⁾ B = inputs and output reverse-polarity protected.

⁸⁾ D = outputs overcurrent and short-circuit protected.

⁹⁾ At U_v ≤ 24V and I_A < 50mA.

¹⁰⁾ Temperature stability following adjustment +/-10 °C.

Power consumption	30 mA
Switching output	PNP
Switching mode	Dark switching
Signal voltage PNP HIGH/LOW	$V_S - (\leq 3\text{ V}) / \text{approx. } 0\text{ V}$
Output current I_{max}	100 mA ³⁾
Response time	< 500 μs ⁴⁾
Switching frequency	1,000 Hz ⁵⁾
Connection type	Connector M12, 3-pin
Circuit protection	A ⁶⁾ B ⁷⁾ D ⁸⁾
Protection class	III
Polarisation filter	✓
Housing material	Plastic, ABS
Optics material	Plastic, PMMA
Enclosure rating	IP67
Items supplied	Fastening nuts (2 x)
Special feature	Detecting transparent objects
EMC	EN 60947-5-2
Ambient operating temperature	-25 °C ... +55 °C ¹⁰⁾ ⁹⁾
Ambient storage temperature	-40 °C ... +70 °C
UL File No.	NRKH.E348498 & NRKH7.E348498

¹⁾ Limit values. Operated in short-circuit protected network: max. 8 A.

²⁾ May not exceed or fall below U_V tolerances.

³⁾ At $U_V > 24\text{ V}$ or ambient temperature > 49 °C, $I_A \text{ max.} = 50\text{ mA}$.

⁴⁾ Signal transit time with resistive load.

⁵⁾ With light/dark ratio 1:1.

⁶⁾ A = V_S connections reverse-polarity protected.

⁷⁾ B = inputs and output reverse-polarity protected.

⁸⁾ D = outputs overcurrent and short-circuit protected.

⁹⁾ At $U_V \leq 24\text{ V}$ and $I_A < 50\text{ mA}$.

¹⁰⁾ Temperature stability following adjustment +/-10 °C.

Safety-related parameters

MTTF_D	2,091 years
DC_{avg}	0%

Classifications

ECl@ss 5.0	27270902
ECl@ss 5.1.4	27270902
ECl@ss 6.0	27270902
ECl@ss 6.2	27270902
ECl@ss 7.0	27270902
ECl@ss 8.0	27270902
ECl@ss 8.1	27270902

ECl@ss 9.0	27270902
ETIM 5.0	EC002717
ETIM 6.0	EC002717
UNSPSC 16.0901	39121528

Connection diagram

Cd-045

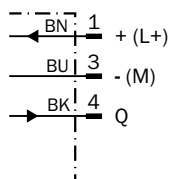

Characteristic curve

GRL18S

Operating reserve

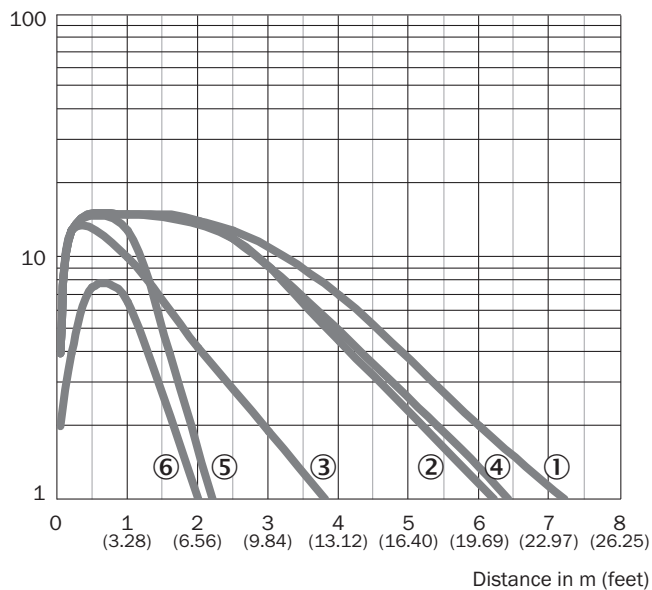

- ① Reflector PL80A
- ② Reflector PL40A
- ③ Reflector PL20A
- ④ Reflector P250
- ⑤ Reflector PL22
- ⑥ Reflective tape REF-Plus 3436

Light spot size

GRL18S

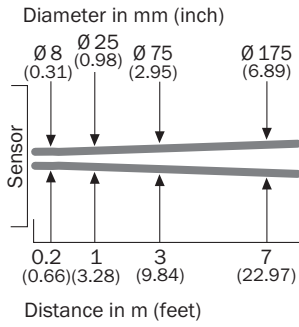

Sensing range diagram

GRL18S

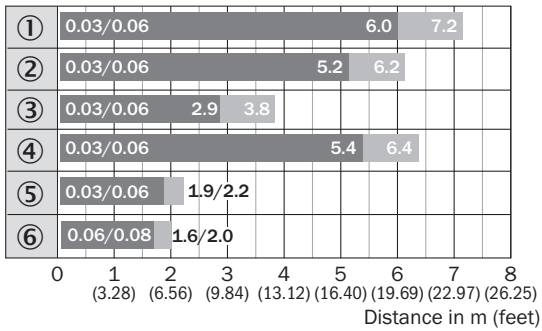

■ Sensing range ■ Sensing range max.

- ① Reflector PL80A
- ② Reflector PL40A
- ③ Reflector PL20A
- ④ Reflector P250
- ⑤ Reflector PL22
- ⑥ Reflective tape REF-Plus 3436

Dimensional drawing (Dimensions in mm (inch))

GR18S, plastic, connector, straight, adjustable

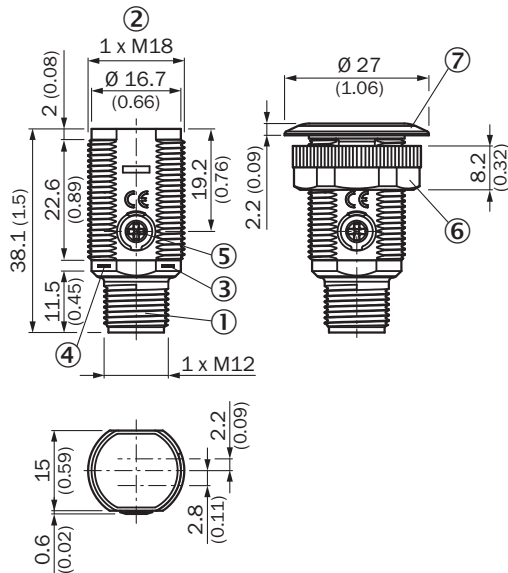







- ① Connector M12, 3-pin
- ② Threaded mounting hole M18 x 1
- ③ LED indicator yellow
- ④ LED indicator green
- ⑤ Sensitivity control: potentiometer 270°
- ⑥ Fastening nut; 22 mm hex, plastic
- ⑦ Mounting ring

Recommended accessories

Other models and accessories → www.sick.com/GR18S

	Brief description	Type	Part no.
Reflectors			
	Rectangular, screw connection, 80 mm x 80 mm, PMMA/ABS, Screw-on, 2 hole mounting	PL80A	1003865
	Fine triple reflector, screw connection, suitable for laser sensors, 47 mm x 47 mm, PMMA/ABS, Screw-on, 2 hole mounting	P250F	5308843
	Fine triple reflector, screw connection, suitable for laser sensors, 18 mm x 18 mm, PMMA/ABS, Screw-on, 2 hole mounting	PL10F	5311210
	Fine triple reflector, screw connection, suitable for laser sensors, 38 mm x 16 mm, PMMA/ABS, Screw-on, 2 hole mounting	PL20F	5308844
	Fine triple reflector, screw connection, suitable for laser sensors, 56 mm x 28 mm, PMMA/ABS, Screw-on, 2 hole mounting	PL30F	5326523

	Brief description	Type	Part no.
	Fine triple reflector, screw connection, suitable for laser sensors, 76 mm x 45 mm, PMMA/ABS, Screw-on, 2 hole mounting	PL81-1F	5325060
	Suitable for laser sensors, self-adhesive, cut, see alignment note, 56.3 mm x 56.3 mm, self-adhesive	REF-AC1000-56	4063030
	Fine triple reflector, chemically resistant, screw connection, 18 mm x 18 mm, plastic, Screw-on, 2 hole mounting	PL10F CHEM	5321636
	Chemically resistant, screw connection, suitable for laser sensors, 16 mm x 38 mm, plastic, Screw-on, 2 hole mounting	PL20F-CHEM	5326089
	Stainless steel reflector, hygienic design, chemically resistant, enclosure rating IP69K, D12 adapter shaft, PMMA front screens, 25 mm x 25 mm, Stainless steel V4A (1.4404, 316L), D12-adapter shaft	PLH25-D12	2063404
	Stainless steel reflector, hygienic design, chemically resistant, Enclosure rating IP 69K, M12-adapter thread, PMMA front screens, 25 mm x 25 mm, Stainless steel V4A (1.4404, 316L), M12-adapter thread	PLH25-M12	2063403
	Stainless steel reflector, washdown design, chemically resistant, IP 69K enclosure rating, screw connection, PMMA front screens, 14 mm x 14 mm, Stainless steel V4A (1.4404, 316L), Screw-on, 2 hole mounting	PLV14-A	2063405

SICK AT A GLANCE

SICK is one of the leading manufacturers of intelligent sensors and sensor solutions for industrial applications. A unique range of products and services creates the perfect basis for controlling processes securely and efficiently, protecting individuals from accidents and preventing damage to the environment.

We have extensive experience in a wide range of industries and understand their processes and requirements. With intelligent sensors, we can deliver exactly what our customers need. In application centers in Europe, Asia and North America, system solutions are tested and optimized in accordance with customer specifications. All this makes us a reliable supplier and development partner.

Comprehensive services complete our offering: SICK LifeTime Services provide support throughout the machine life cycle and ensure safety and productivity.

For us, that is “Sensor Intelligence.”

WORLDWIDE PRESENCE:

Contacts and other locations –www.sick.com