

Data sheet | Item number: 262-262

4-conductor terminal strip; without push-buttons; with snap-in mounting feet; 12-pole; for plate thickness 0.6 - 1.2 mm; Fixing hole 3.5 mm Ø; 4 mm²; CAGE CLAMP®; 4,00 mm²; gray

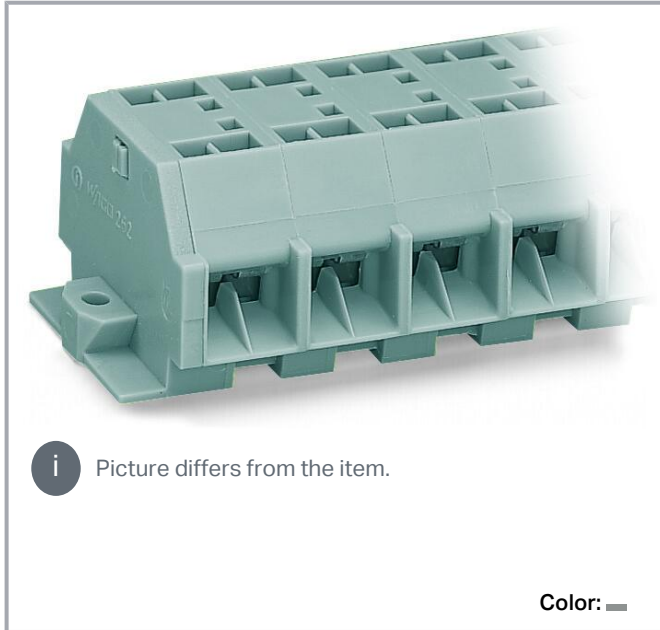

www.wago.com/262-262



i Picture differs from the item.

Color:

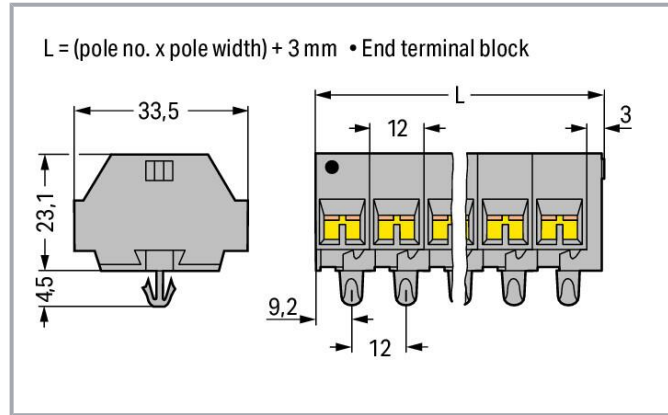

Data

Electrical data

Ratings per IEC/EN

Nominal voltage (III/3)	630 V
Rated impulse voltage (III/3)	8 kV
Rated current	32 A
Legend (ratings)	(III / 3) ≙ Overvoltage category III / Pollution degree 3

Connection data

Connection points	48
Total number of potentials	12
Number of levels	1

Connection 1

Connection technology

Subject to changes. Please also observe the further product documentation!

WAGO GmbH & Co. KG
Hansastr. 27
32423 Minden
Phone: +49571 887-0 | Fax: +49571 887-169
Email: info.de@wago.com | Web: www.wago.com

Do you have any questions about our products?
We are always happy to take your call at +49 (571) 887-44222.



	CAGE CLAMP®
Actuation type	Operating tool
Connectable conductor materials	Copper
Solid conductor	0.08 ... 4 mm ² / 28 ... 12 AWG
Fine-stranded conductor	0.08 ... 4 mm ² / 28 ... 12 AWG
Strip length	9 ... 10 mm / 0.35 ... 0.39 inches
Pole number	12
Wiring direction	Side-entry wiring

Physical data

Width	147 mm / 5.787 inches
Height from the surface	23.1 mm / 0.909 inches
Depth	33.5 mm / 1.319 inches
Module width	12 mm / 0.472 inches

Mechanical Data

Design	horizontal type
Mounting type	Snap-in foot
Marking level	Side marking

Material Data

Note (material data)	Information on material specifications can be found here
Color	gray
Material group	I
Insulation material	Polyamide (PA66)
Flammability class per UL94	V0
Fire load	1.395 MJ
Halogen-free	Yes
Weight	85 g

Environmental requirements

Processing temperature	-35 ... +85 °C
Continuous operating temperature	-60 ... +105 °C

Subject to changes. Please also observe the further product documentation!

Commercial data

eCl@ss 10.0	27-14-11-06
eCl@ss 9.0	27-14-11-06
ETIM 8.0	EC001284
ETIM 7.0	EC001284
PU (SPU)	25 pcs
Packaging type	box
Country of origin	DE
GTIN	4044918641760
Customs tariff number	85369010000

Environmental Product Compliance

RoHS Compliance Status	Compliant, No Exemption
------------------------	-------------------------

Approvals / Certificates

General approvals

Logo	Approval	Additional Approval Text	Certificate name
	CCA DEKRA Certification B.V.	EN 60998	NTR-NL 6510
	CCA DEKRA Certification B.V.	EN 60998	2110272.03
	CSA DEKRA Certification B.V.	C22.2	70010891
	UR Underwriters Laboratories Inc.	UL 1059	E45172

Declarations of conformity and manufacturer's declarations

Logo	Approval	Additional Approval Text	Certificate name
	EU-Declaration of Conformity	-	-

Subject to changes. Please also observe the further product documentation!







WAGO GmbH & Co. KG



UK-Declaration of Conformity

WAGO GmbH & Co. KG

Approvals for marine applications

Logo	Approval	Additional Approval Text	Certificate name
	ABS American Bureau of Shipping	-	19- HG1869868- PDA
	BV Bureau Veritas S.A.	EN 60947	07436/F0 BV
	DNV GL Det Norske Veritas, Germanischer Lloyd	-	TAE00001V2
	LR Lloyds Register	IEC 60998	LR22173030TA

Optional accessories

Carrier rail

Mounting accessories

	Item no.: 210-154 Aluminum carrier rail; 1000 mm long; 18 mm wide; 7 mm high; silver-colored	www.wago.com/210-154
--	--	--

Jumpers

Jumper

	Item no.: 262-402 Jumper; for conductor entry; 2-way; insulated; gray	www.wago.com/262-402
---	---	--

Marking accessories

Marking strip

Subject to changes. Please also observe the further product documentation!

WAGO GmbH & Co. KG

Hansastr. 27

32423 Minden

Phone: +49571 887-0 | Fax: +49571 887-169

Email: info.de@wago.com | Web: www.wago.com

Do you have any questions about our products?

We are always happy to take your call at +49 (571) 887-44222.



Item no.: 210-833
Marking strips; 25 m on roll; 6 mm wide; plain; Self-adhesive; white

www.wago.com/210-833

Mounting

Mounting accessories















Item no.: 209-120
Mounting foot; can be snapped on terminal blocks with snap-in mounting foot; for mounting on relay-modules; 6.4 mm wide; gray www.wago.com/209-120



Item no.: 209-137
Mounting adapter; can be used as end stop; 6.5 mm wide; gray www.wago.com/209-137

Ferrule









Ferrule

	Item no.: 216-101 Ferrule; Sleeve for 0.5 mm ² / AWG 22; uninsulated; electro-tin plated; silver-colored www.wago.com/216-101
	Item no.: 216-104 Ferrule; Sleeve for 1.5 mm ² / AWG 16; uninsulated; electro-tin plated; silver-colored www.wago.com/216-104
	Item no.: 216-108 Ferrule; Sleeve for 6 mm ² / AWG 10; uninsulated; electro-tin plated; silver-colored www.wago.com/216-108
	Item no.: 216-109 Ferrule; Sleeve for 10 mm ² / AWG 8; uninsulated; electro-tin plated www.wago.com/216-109
	Item no.: 216-102 Ferrule; Sleeve for 0.75 mm ² / AWG 20; uninsulated; electro-tin plated; silver-colored www.wago.com/216-102
	Item no.: 216-103 Ferrule; Sleeve for 1 mm ² / AWG 18; uninsulated; electro-tin plated www.wago.com/216-103
	Item no.: 216-110 Ferrule; Sleeve for 16 mm ² / AWG 6; uninsulated; electro-tin plated; brown metallic www.wago.com/216-110
	Item no.: 216-123 Ferrule; Sleeve for 1 mm ² / AWG 18; uninsulated; electro-tin plated; silver-colored www.wago.com/216-123
	Item no.: 216-122 Ferrule; Sleeve for 0.75 mm ² / AWG 20; uninsulated; electro-tin plated; silver-colored www.wago.com/216-122
	Item no.: 216-124 Ferrule; Sleeve for 1.5 mm ² / AWG 16; uninsulated; electro-tin plated www.wago.com/216-124
	Item no.: 216-142 Ferrule; Sleeve for 0.75 mm ² / 18 AWG; uninsulated; electro-tin plated; electrolytic copper; gastight crimped; acc. to DIN 46228, Part 1/08.92 www.wago.com/216-142
	Item no.: 216-132 Ferrule; Sleeve for 0.34 mm ² / AWG 24; uninsulated; electro-tin plated www.wago.com/216-132
	Item no.: 216-121 Ferrule; Sleeve for 0.5 mm ² / AWG 22; uninsulated; electro-tin plated; silver-colored www.wago.com/216-121

Subject to changes. Please also observe the further product documentation!

	Item no.: 216-143 Ferrule; Sleeve for 1 mm ² / AWG 18; uninsulated; electro-tin plated; electrolytic copper; gastight crimped; acc. to DIN 46228, Part 1/08.92	www.wago.com/216-143
	Item no.: 216-131 Ferrule; Sleeve for 0.25 mm ² / AWG 24; uninsulated; electro-tin plated; silver-colored	www.wago.com/216-131
	Item no.: 216-141 Ferrule; Sleeve for 0.5 mm ² / 20 AWG; uninsulated; electro-tin plated; electrolytic copper; gastight crimped; acc. to DIN 46228, Part 1/08.92	www.wago.com/216-141
	Item no.: 216-152 Ferrule; Sleeve for 0.34 mm ² / AWG 24; uninsulated; electro-tin plated	www.wago.com/216-152
	Item no.: 216-203 Ferrule; Sleeve for 1 mm ² / AWG 18; insulated; electro-tin plated; red	www.wago.com/216-203
	Item no.: 216-206 Ferrule; Sleeve for 2.5 mm ² / AWG 14; insulated; electro-tin plated; blue	www.wago.com/216-206
	Item no.: 216-202 Ferrule; Sleeve for 0.75 mm ² / 18 AWG; insulated; electro-tin plated; gray	www.wago.com/216-202
	Item no.: 216-151 Ferrule; Sleeve for 0.25 mm ² / AWG 24; uninsulated; electro-tin plated	www.wago.com/216-151
	Item no.: 216-204 Ferrule; Sleeve for 1.5 mm ² / AWG 16; insulated; electro-tin plated; black	www.wago.com/216-204
	Item no.: 216-209 Ferrule; Sleeve for 10 mm ² / AWG 8; insulated; electro-tin plated; red	www.wago.com/216-209
	Item no.: 216-205 Ferrule; Sleeve for 2.08 mm ² / AWG 14; insulated; electro-tin plated; yellow	www.wago.com/216-205
	Item no.: 216-144 Ferrule; Sleeve for 1.5 mm ² / AWG 16; uninsulated; electro-tin plated; electrolytic copper; gastight crimped; acc. to DIN 46228, Part 1/08.92; silver-colored	www.wago.com/216-144
	Item no.: 216-208 Ferrule; Sleeve for 6 mm ² / AWG 10; insulated; electro-tin plated; electrolytic copper; gastight crimped; acc. to DIN 46228, Part 4/09.90; yellow	www.wago.com/216-208
	Item no.: 216-201 Ferrule; Sleeve for 0.5 mm ² / 20 AWG; insulated; electro-tin plated; white	www.wago.com/216-201
	Item no.: 216-223 Ferrule; Sleeve for 1 mm ² / AWG 18; insulated; electro-tin plated; red	www.wago.com/216-223
	Item no.: 216-210 Ferrule; Sleeve for 16 mm ² / AWG 6; insulated; electro-tin plated; electrolytic copper; gastight crimped; acc. to DIN 46228, Part 4/09.90; blue	www.wago.com/216-210
	Item no.: 216-241 Ferrule; Sleeve for 0.5 mm ² / 20 AWG; insulated; electro-tin plated; electrolytic copper; gastight crimped; acc. to DIN 46228, Part 4/09.90; white	www.wago.com/216-241
	Item no.: 216-242	

Subject to changes. Please also observe the further product documentation!

	Ferrule; Sleeve for 0.75 mm ² / 18 AWG; insulated; electro-tin plated; electrolytic copper; gastight crimped; acc. to DIN 46228, Part 4/09.90; gray	www.wago.com/216-242
	Item no.: 216-222 Ferrule; Sleeve for 0.75 mm ² / 18 AWG; insulated; electro-tin plated; gray	www.wago.com/216-222
	Item no.: 216-221 Ferrule; Sleeve for 0.5 mm ² / 20 AWG; insulated; electro-tin plated; white	www.wago.com/216-221
	Item no.: 216-224 Ferrule; Sleeve for 1.5 mm ² / AWG 16; insulated; electro-tin plated; black	www.wago.com/216-224
	Item no.: 216-243 Ferrule; Sleeve for 1 mm ² / AWG 18; insulated; electro-tin plated; electrolytic copper; gastight crimped; acc. to DIN 46228, Part 4/09.90; red	www.wago.com/216-243
	Item no.: 216-244 Ferrule; Sleeve for 1.5 mm ² / AWG 16; insulated; electro-tin plated; electrolytic copper; gastight crimped; acc. to DIN 46228, Part 4/09.90; black	www.wago.com/216-244
	Item no.: 216-263 Ferrule; Sleeve for 1 mm ² / AWG 18; insulated; electro-tin plated; electrolytic copper; gastight crimped; acc. to DIN 46228, Part 4/09.90; red	www.wago.com/216-263
	Item no.: 216-246 Ferrule; Sleeve for 2.5 mm ² / AWG 14; insulated; electro-tin plated; electrolytic copper; gastight crimped; acc. to DIN 46228, Part 4/09.90; blue	www.wago.com/216-246
	Item no.: 216-266 Ferrule; Sleeve for 2.5 mm ² / AWG 14; insulated; electro-tin plated; electrolytic copper; gastight crimped; acc. to DIN 46228, Part 4/09.90; blue	www.wago.com/216-266
	Item no.: 216-264 Ferrule; Sleeve for 1.5 mm ² / AWG 16; insulated; electro-tin plated; electrolytic copper; gastight crimped; acc. to DIN 46228, Part 4/09.90; black	www.wago.com/216-264
	Item no.: 216-284 Ferrule; Sleeve for 1.5 mm ² / AWG 16; insulated; electro-tin plated; electrolytic copper; gastight crimped; acc. to DIN 46228, Part 4/09.90; black	www.wago.com/216-284
	Item no.: 216-286 Ferrule; Sleeve for 2.5 mm ² / AWG 14; insulated; electro-tin plated; electrolytic copper; gastight crimped; acc. to DIN 46228, Part 4/09.90; blue	www.wago.com/216-286
	Item no.: 216-287 Ferrule; Sleeve for 4 mm ² / AWG 12; insulated; electro-tin plated; electrolytic copper; gastight crimped; acc. to DIN 46228, Part 4/09.90; gray	www.wago.com/216-287
	Item no.: 216-262 Ferrule; Sleeve for 0.75 mm ² / 18 AWG; insulated; electro-tin plated; electrolytic copper; gastight crimped; acc. to DIN 46228, Part 4/09.90; gray	www.wago.com/216-262
	Item no.: 216-288 Ferrule; Sleeve for 6 mm ² / AWG 10; insulated; electro-tin plated; electrolytic copper; gastight crimped; acc. to DIN 46228, Part 4/09.90; yellow	www.wago.com/216-288
	Item no.: 216-289 Ferrule; Sleeve for 10 mm ² / AWG 8; insulated; electro-tin plated; electrolytic copper; gastight crimped; acc. to DIN 46228, Part 4/09.90; red	www.wago.com/216-289
	Item no.: 216-301	

Subject to changes. Please also observe the further product documentation!

Ferrule; Sleeve for 0.25 mm² / AWG 24; insulated; electro-tin plated; yellow

www.wago.com/216-301



Item no.: 216-321

Ferrule; Sleeve for 0.25 mm² / AWG 24; insulated; electro-tin plated; yellow

www.wago.com/216-321



Item no.: 216-322

Ferrule; Sleeve for 0.34 mm² / 22 AWG; insulated; electro-tin plated; light turquoise

www.wago.com/216-322



Item no.: 216-267

Ferrule; Sleeve for 4 mm² / AWG 12; insulated; electro-tin plated; electrolytic copper; gastight crimped; acc. to DIN 46228, Part 4/09.90; gray

www.wago.com/216-267



Item no.: 216-302

Ferrule; Sleeve for 0.34 mm² / 22 AWG; insulated; electro-tin plated; light turquoise

www.wago.com/216-302

Testing and measuring

Testing accessories



Item no.: 249-140

Test plug module; without locking device; modular; for 4-conductor terminal blocks; gray

www.wago.com/249-140

Tool

Operating tool



Item no.: 210-657

Operating tool; Blade: 3.5 x 0.5 mm; with a partially insulated shaft; short; multicoloured

www.wago.com/210-657



Item no.: 210-658

Operating tool; Blade: 3.5 x 0.5 mm; with a partially insulated shaft; angled; short; multicoloured

www.wago.com/210-658



Item no.: 210-720

Operating tool; Blade: 3.5 x 0.5 mm; with a partially insulated shaft; multicoloured

www.wago.com/210-720

Downloads

Documentation

Bid Text

262-262 X81 - Datei	2019 Feb 19	xml 3.2 kB	Download
------------------------	-------------	---------------	----------

262-262 doc - Datei	2017 Aug 17	doc 26.1 kB	Download
------------------------	-------------	----------------	----------

Additional Information

Technical Section		pdf 2.2 MB	Download
-------------------	--	---------------	----------

Subject to changes. Please also observe the further product documentation!



Technical explanations

CAD/CAE-Data

CAD data

2D/3D Models 262-262	URL	Download
----------------------	---------------------	--------------------------

CAE data

EPLAN Data Portal 262-262	URL	Download
---------------------------	---------------------	--------------------------

WSCAD Universe 262-262	URL	Download
------------------------	---------------------	--------------------------

ZUKEN Portal 262-262	URL	Download
----------------------	---------------------	--------------------------

Environmental Product Compliance

Compliance Search

Environmental Product Compliance 262-262	URL	Download
--	---------------------	--------------------------

4-conductor terminal strip; without push-buttons; with snap-in mounting feet; 12-pole; for plate thickness 0.6 - 1.2 mm; Fixing hole 3.5 mm Ø; 4 mm²; CAGE CLAMP®; 4,00 mm²; gray

Installation Notes

Conductor termination

Subject to changes. Please also observe the further product documentation!

WAGO GmbH & Co. KG
Hansastr. 27
32423 Minden
Phone: +49571 887-0 | Fax: +49571 887-169
Email: info.de@wago.com | Web: www.wago.com

Do you have any questions about our products?
We are always happy to take your call at +49 (571) 887-44222.

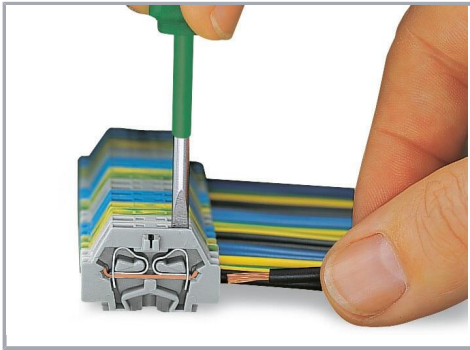

CAGE CLAMP® connection

Inserting a conductor.

With ferruled conductors, it is necessary to use a terminal block one size larger than the conductor's nominal cross-section.

Commoning

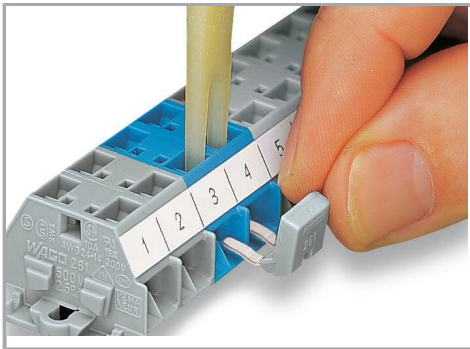

Commoning with comb-style jumper bar.

Installation

Subject to changes. Please also observe the further product documentation!

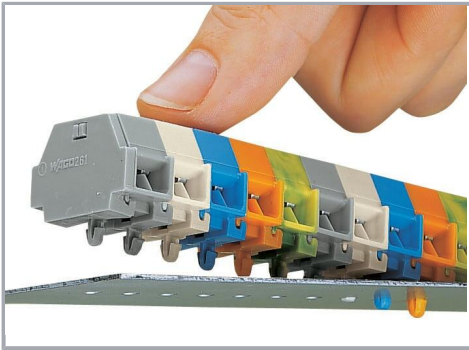

Mounting a terminal strip with snap-in feet into holes.

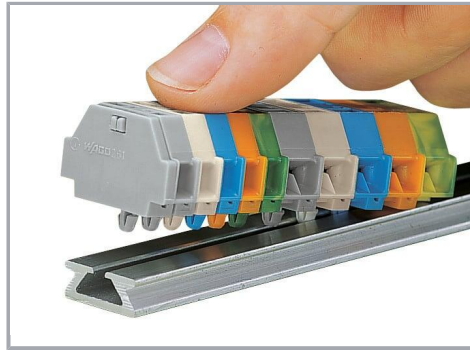

Mounting a terminal strip with snap-in feet onto aluminum rail.

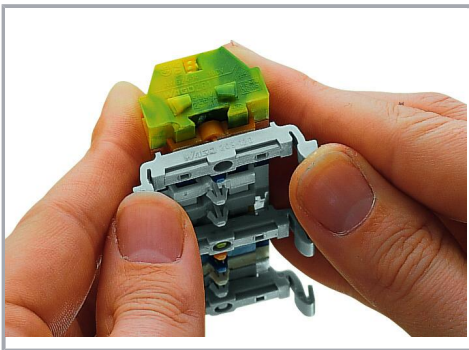

Terminal strip with snap-in mounting feet
Snapping a mounting foot (209-120).

(Distance between mounting feet: approx. 25
... 30 mm)

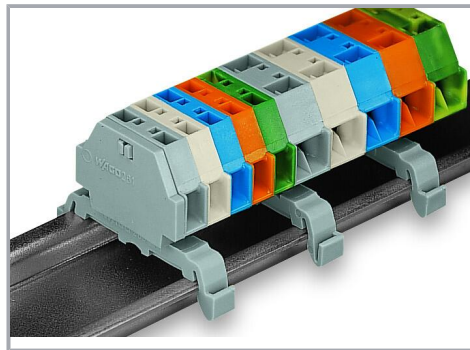

Terminal strip; with snap-in mounting feet; for
DIN-35 rail

Subject to changes. Please also observe the further product documentation!

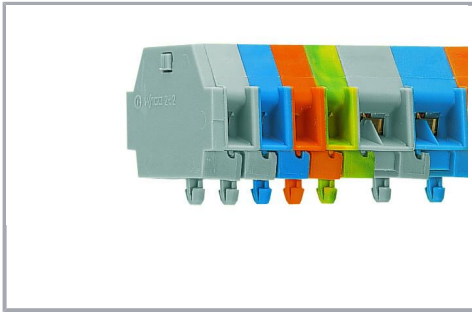

Terminal strip with snap-in mounting feet, for 0.6 ... 1.2 mm plate thickness, 3.5 mm mounting hole diameter (also for 210-154 Aluminum Rail or with 209-120 Mounting Foot for DIN-35 rail)

Marking

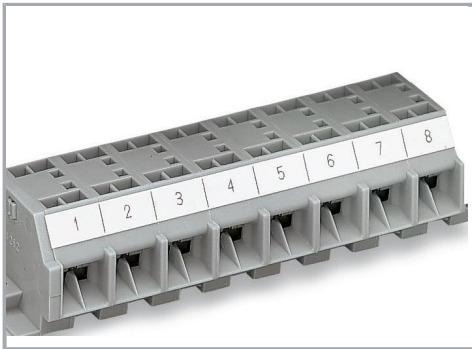

Marking with self-adhesive marking strips.

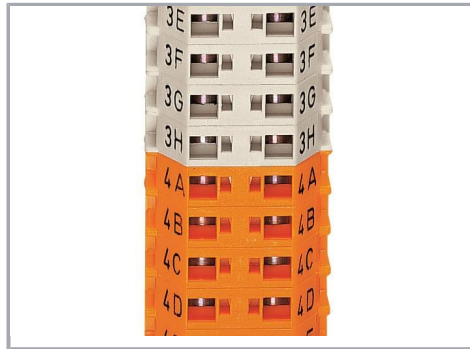

Marking by direct printing (upon request).

Subject to changes. Please also observe the further product documentation!