

THIS DOCUMENT IS THE PROPERTY OF
KEYSTONE ELECTRONICS CORP. AND
SHALL NOT BE REPRODUCED, DISTRIBUTED
OR USED AS A BASIS FOR MANUFACTURE
WITHOUT PRIOR WRITTEN PERMISSION
FROM KEYSTONE ELECTRONICS CORP.

ACTUAL SIZE

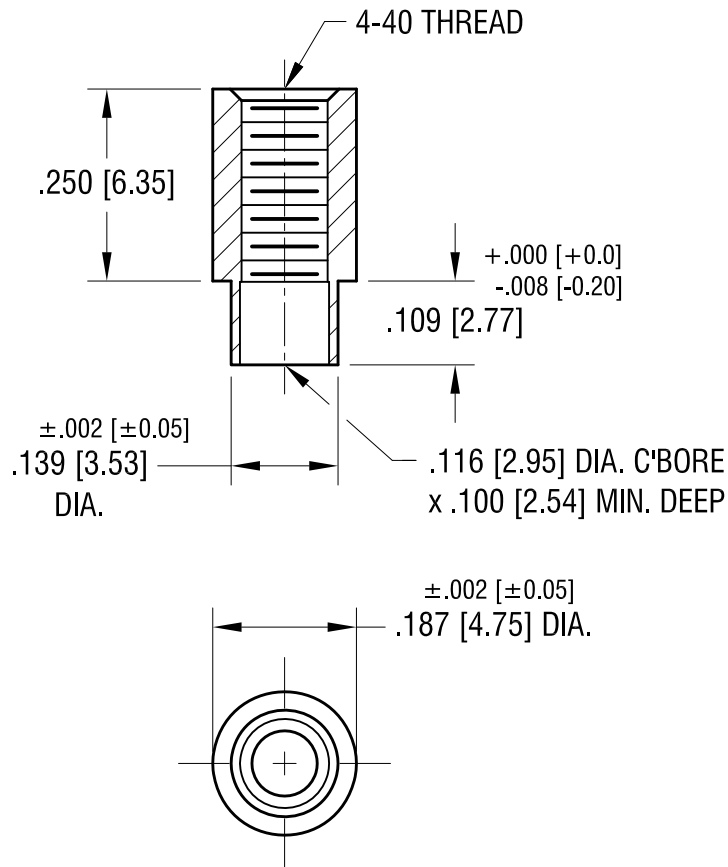

11.22.21	CHANGE AS PER ECN 21-153	A
DATE	DESCRIPTION	REV.

KEYSTONE ELECTRONICS CORP.			
www.keyelco.com • NEW HYDE PARK, NY 11040 • Tel (516) 328-7500			
PART NAME			
SWAGE THREADED STANDOFF			
MATERIAL			
BRASS			
FINISH	DUCTILE NICKEL PLATE	DRN BY	BOONE
		APP'D	LN
		DATE	6.30.99
		SCALE	4X
TOLERANCES	INCH [MM]	CODE	DWG NO.
DECIMAL	± .005 [± 0.13]	C	2262-2
ANGULAR	± 1°		
UNLESS OTHERWISE SPECIFIED			