

Click to  
**ORDER**  
samples

## AME60-VZ



Encapsulated

The new AME60-VZ is a brand-new AC/DC converter that offers much greater cost effectiveness due to material normalization and production automation also leading to improved reliability and performance. Offering a commercial input voltage range of 85-264VAC and an output voltage range from 5-48V, this series will offer many benefits to your new system design.

This new series offers great operating temperatures, from -40°C to 70°C with full power up to 55°C depending on models also features a 4000VAC isolation for improved reliability and system safety.

Furthermore, a higher MTBF of 300,000h, output short circuit protection (OSCP), output over-current protection (OCP) and an output over-voltage protection (OVP) come standard with the series.

The AME60-SVZ is suitable for street lighting controls, grid power, instrumentation, industrial controls and communication applications.

## Features



- Universal Input: 85 - 264VAC/100 - 370VDC
- Operating temperature range: -40°C to +70°C
- High isolation voltage: 4000VAC
- Regulated output, Low ripple & noise
- Output short circuit, over-current, over-voltage protection
- EMI performance meets CISPR32/EN55032 CLASS B
- Approval UL62368-1; designed to meet IEC/EN62368-1 standards



## Summary

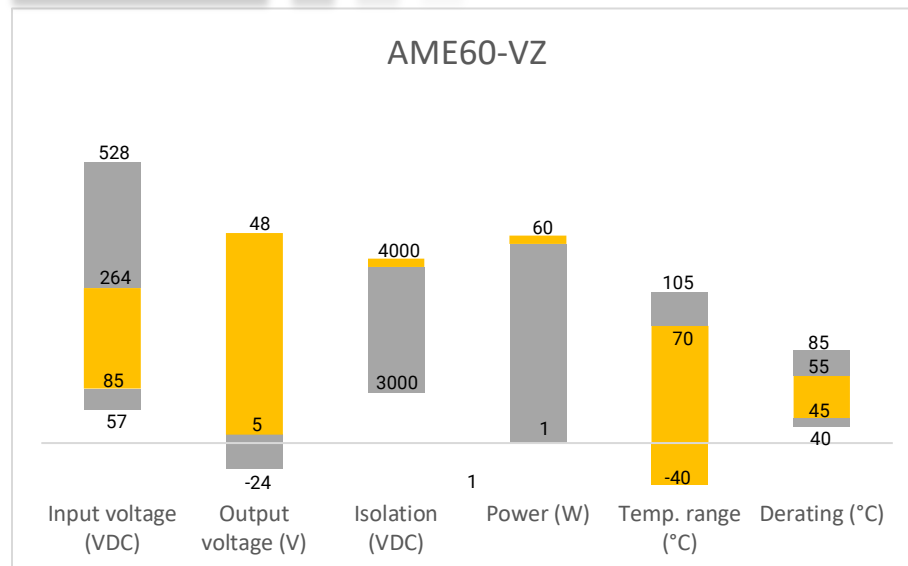

## Training

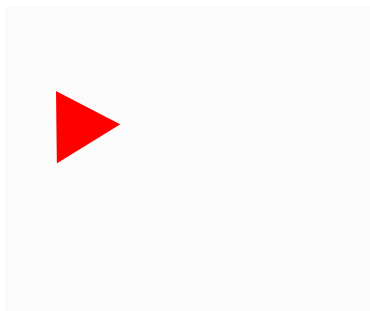

Product Training Video  
(click to open)

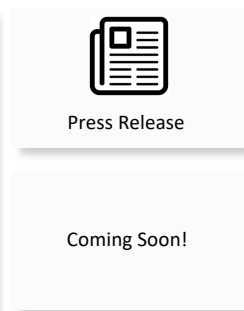

Application Notes

## Applications



Power Grid



Industrial



Telecom



Instrumentation

## Models & Specifications

Single Output							
Model	Input Voltage (VAC/Hz)	Input Voltage (VDC)	Max Output wattage (W)	Output Voltage (V)	Output Current max (A)	Maximum capacitive load (μF)	Efficiency @ 230VAC (%)
AME60-5SVZ	85-264/47-63	100-370	50	5	10	50,000	82
AME60-12SVZ	85-264/47-63	100-370	60	12	5	10,000	86
AME60-15SVZ	85-264/47-63	100-370	60	15	4	8,000	86
AME60-24SVZ	85-264/47-63	100-370	60	24	2.5	2,700	86
AME60-48SVZ	85-264/47-63	100-370	60	48	1.25	680	86

Note: Use suffix "ST" for chassis and suffix "STD" for DIN-Rail mounting (ex. AME60-5SVZ-ST is chassis mounting and AME60-5SVZ-STD is DIN-Rail mounting version).

Input Specifications					
Parameters	Conditions	Minimum	Typical	Maximum	Units
Current	115VAC			1.4	A
	230VAC			0.8	A
Inrush current <2ms (cold start)	115VAC		45		A
	230VAC		90		A
Leakage current				0.25	mA
External fuse	slow blow type	3.15			A

Output Specifications				
Parameters	Conditions	Typical	Maximum	Units
Voltage accuracy		±2		%
Line regulation	Full load	±0.5		%
Load regulation	0-100% load	±1		%
Ripple & Noise*	20MHz bandwidth		150	mV p-p
Hold up time	115VAC	8		ms
	230VAC	65		ms
Voltage adjustment range			±10	%

\* Ripple and Noise are measured at 20MHz bandwidth by using the referenced Application circuit.

Isolation Specifications				
Parameters	Conditions	Typical	Rated	Units
Tested I/O voltage	60 sec, leakage current < 5mA		4000	VAC

General Specifications				
Parameters	Conditions	Typical	Maximum	Units
Protection class		Class I		
Over Current protection	Auto recovery	≥ 110		% of Iout
Over voltage protection	5V Vout		≤ 9	VDC
	12V Vout		≤ 16	

	15V Vout		≤ 24	
	24V Vout		≤ 35	
	48V Vout		≤ 60	
Short circuit protection	Hiccup, Continuous			
Short circuit restart	Auto recovery			
Operating temperature	See derating graph	-40 to +70		°C
Maximum case temperature		100		°C
Storage temperature		-40 to +85		°C
Lead temperature	Wave soldering	260 ± 5 °C; time : 5 - 10s		
	Hand soldering	360 ± 10 °C; time : 3 - 5s		
Power consumption	5V/12V/15V/24V models		0.5	W
	48V model		0.65	
Temperature coefficient		±0.02		% / °C
Cooling	Free air convection			
Humidity	Non-condensing		95	% RH
Case material	Heat resistant black Plastic (flammability to UL 94V-0)			
Weight	PCB mountable models		310	g
	With optional -ST mounting plate:		400	
	With optional -STD mounting plate:		470	
Dimensions (L x W x H)	PCB mountable models	4.29 x 2,30 x 1.18 inches (109.0 x 58.5 x 30.0mm)		
	With optional -ST mounting plate:	5.32 x 2,76 x 1.52 inches (135.0 x 70.0 x 38.5mm)		
	With optional -STD mounting plate:	5.39 x 2,76 x 1.73 inches (137.0 x 70.0 x 44.0mm)		
MTBF	> 300 000 hrs (MIL-HDBK -217F, t=+25°C)/Full Load			
<b>NOTE: All specifications in this datasheet are measured at an ambient temperature of 25°C, humidity&lt;75%, nominal input voltage and at rated output load unless otherwise specified.</b>				

## Safety Specifications

### Parameters

Agency approvals	cULus UL 62368-1		
Standards	Information technology Equipment	Design to meet IEC/EN 62368-1	
	EMC - Conducted and radiated emission	CISPR32 / EN55032, class B	
	Electrostatic Discharge Immunity	IEC 61000-4-2 Contact ±6KV / Air ±8KV, Criteria B	
	RF, Electromagnetic Field Immunity	IEC 61000-4-3 10V/m, Criteria A	
	Electrical Fast Transient/Burst Immunity	IEC 61000-4-4 ±4KV, Criteria B	
	Surge Immunity	IEC 61000-4-5 L-L ±2KV/L-G ±4KV, with typical application circuit, Criteria B	
		IEC 61000-4-5 L-L ±4KV/L-G ±6KV, with EMC recommended circuit, Criteria B	
	RF, Conducted Disturbance Immunity	IEC 61000-4-6 10Vr.m.s, Criteria A	
Voltage dips, Short Interruptions Immunity	IEC 61000-4-11 0%, 70%, Criteria B		

## Derating

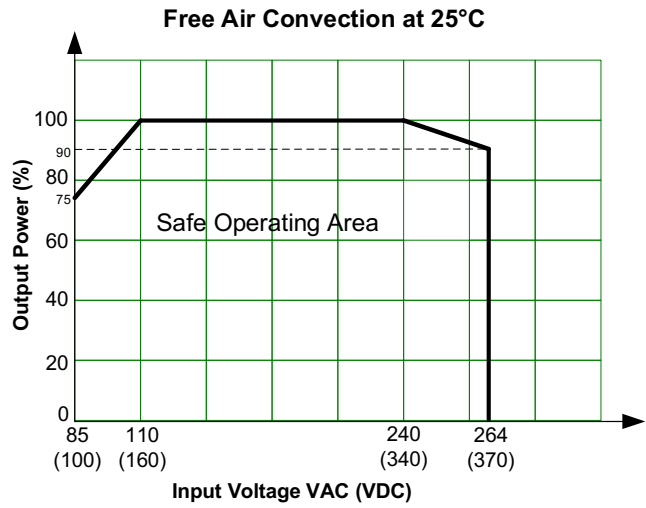
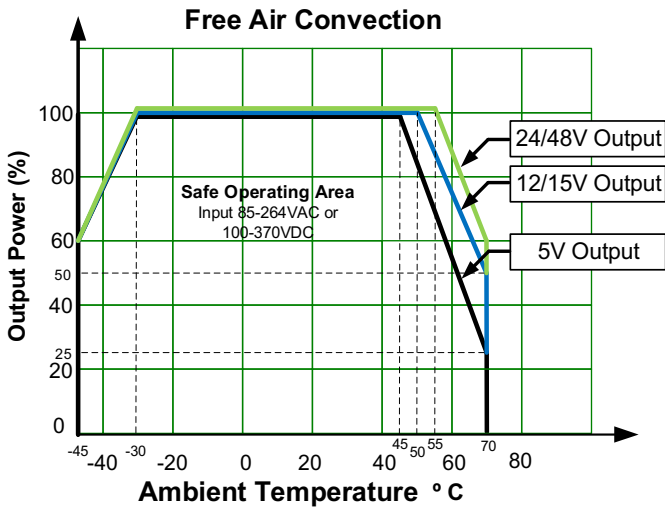

## Typical Application Circuit

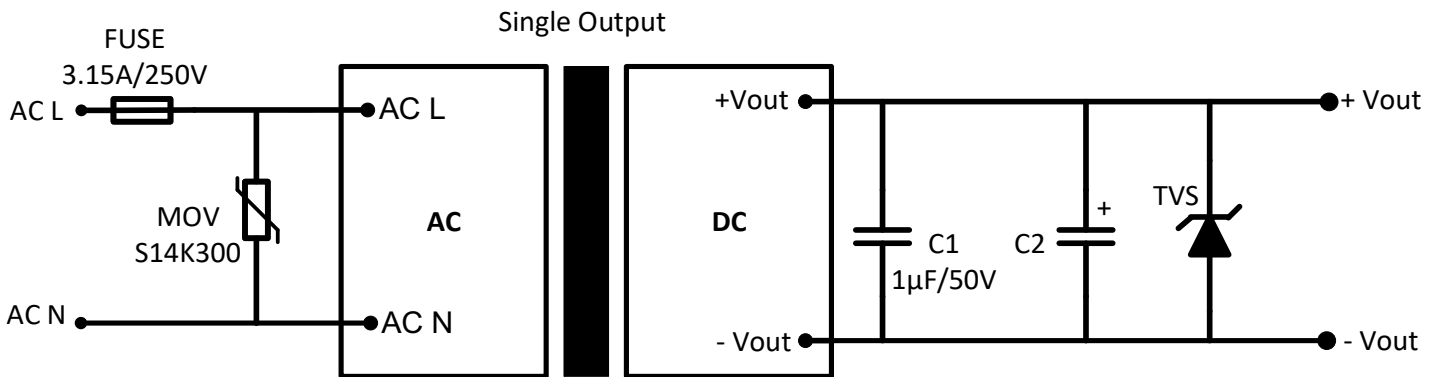

Model	C2	TVS
5 Vout	680 µF / 10V	7V
12 / 15 Vout	330 µF / 25V	20V
24 Vout	200 µF / 35V	30V
48 Vout	100 µF / 63V	64V

### Output Filter Components:

We recommend using an electrolytic capacitor with high frequency, and low ESR rating for C2. C1 is a ceramic capacitor used for filtering high-frequency noise and TVS is a recommended suppressor diode.

## EMC Recommended Circuit

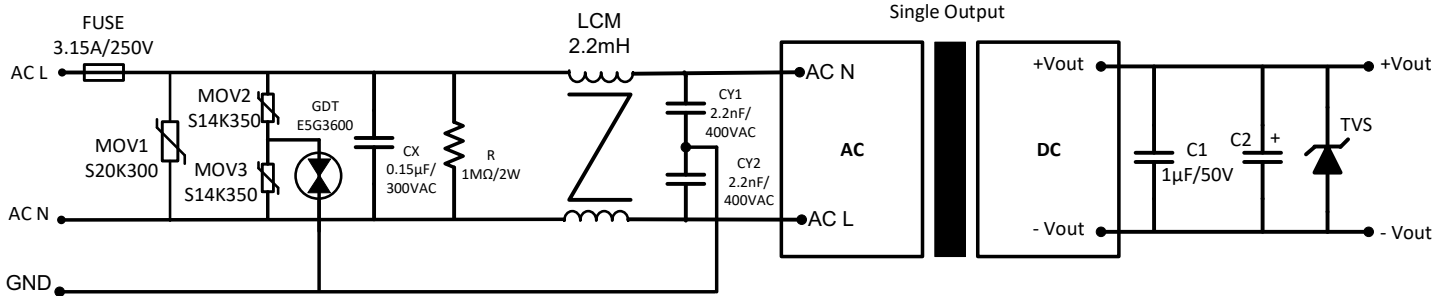

## Dimensions

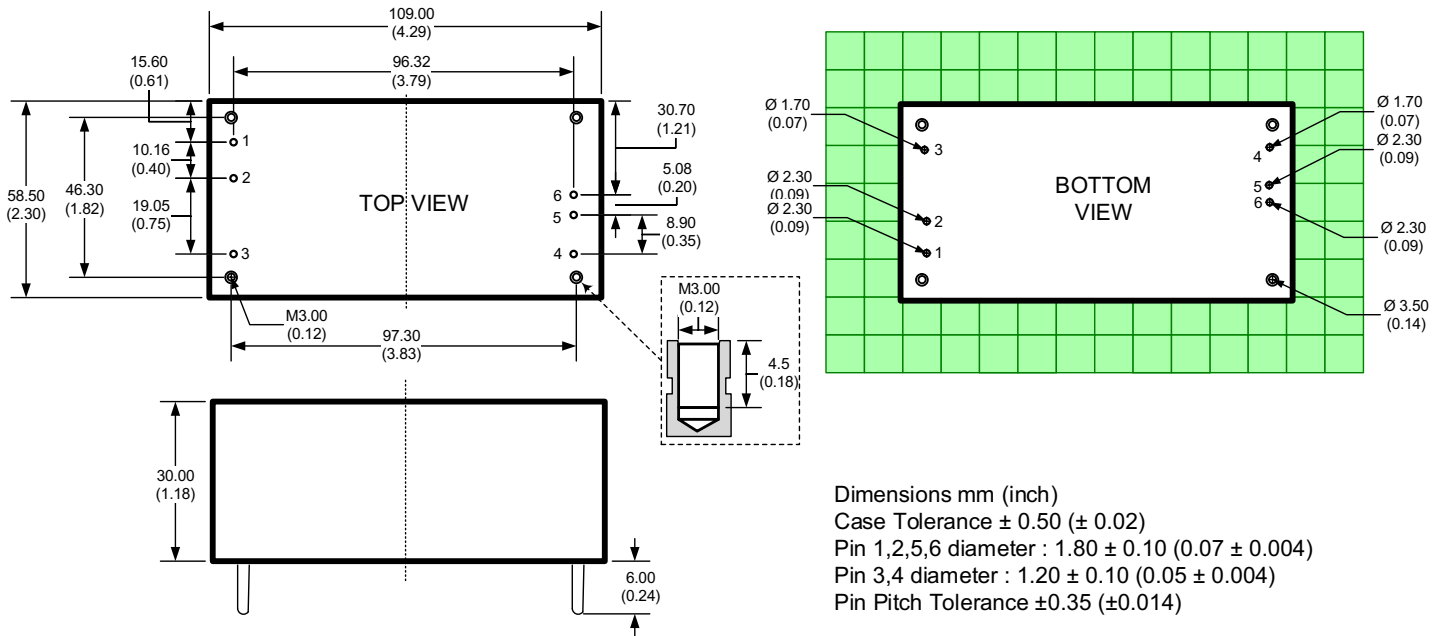

### Pin Output Specifications

Pin	Single
1	AC Input (N)
2	AC Input (L)
3	GND
4	Trim
5	-V Output
6	+V Output

## Dimensions with ST Optional

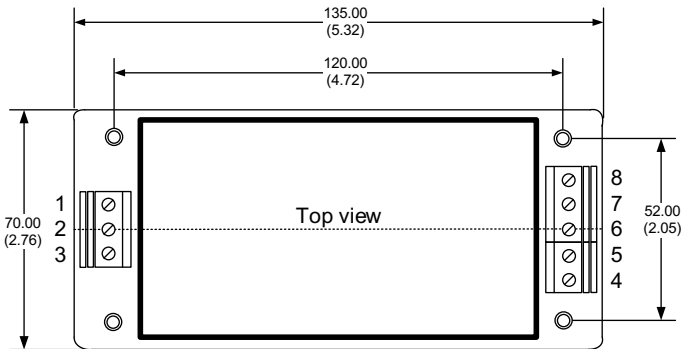

Pin Output Specifications	
Pin	Single
1	AC Input (N)
2	AC Input (L)
3	GND
4	Trim
5	-V Output
6	+V Output
7	NC
8	NC

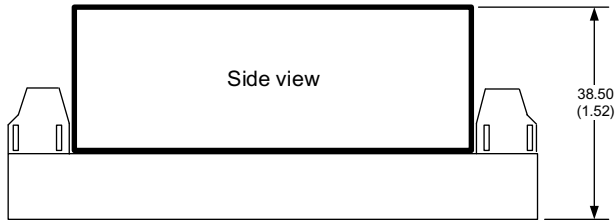

## Dimensions with STD Optional

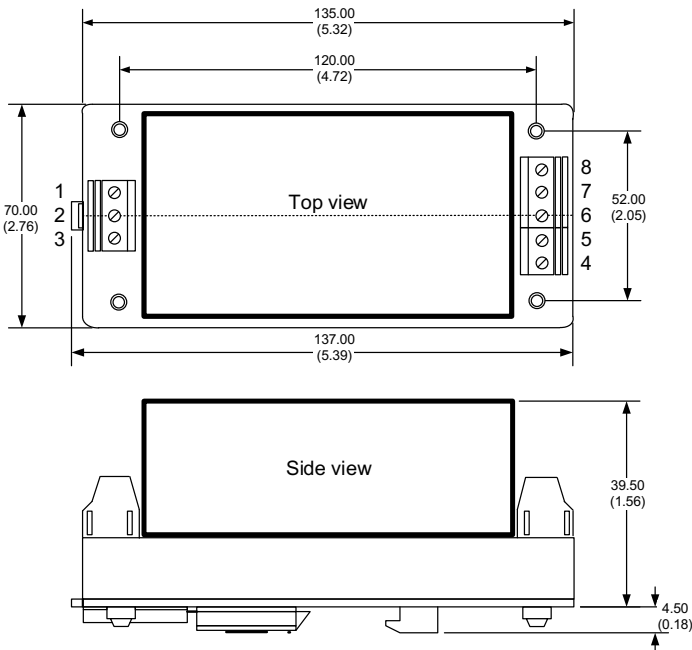

Pin Output Specifications	
Pin	Single
1	AC Input (N)
2	AC Input (L)
3	GND
4	Trim
5	-V Output
6	+V Output
7	NC
8	NC

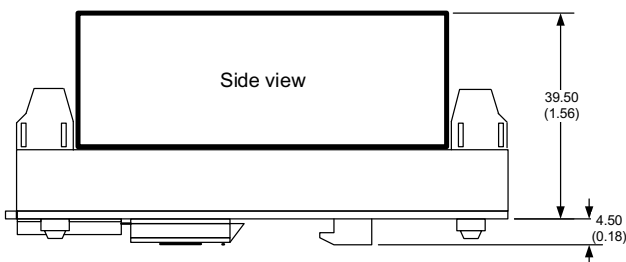

## Trimming

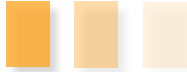

Output voltage can be externally trimmed by utilizing the methods as shown below

### Fixed Resistor      Variable Potentiometer

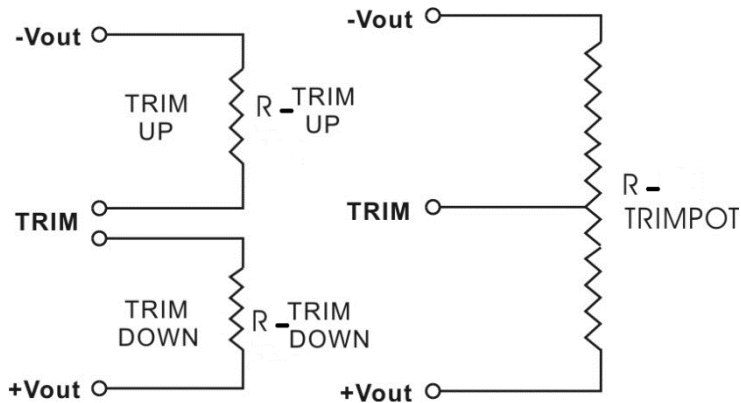

Leave open if not used.

### AME60-5SVZ

Trim down %	1	2	3	4	5	6	7	8	9	10
Vout (VDC)	4.95	4.9	4.85	4.8	4.75	4.7	4.65	4.6	4.55	4.5
Rt down (K $\Omega$ )	160.7	78.2	50.7	36.95	28.7	23.2	19.271	16.325	14.033	12.2
Trim up %	1	2	3	4	5	6	7	8	9	10
Vout (VDC)	5.05	5.1	5.15	5.2	5.25	5.3	5.35	5.4	5.45	5.5
Rt up (K $\Omega$ )	164	81.5	54	40.25	32	26.5	22.571	19.625	17.333	15.5

### AME60-12SVZ

Trim down %	1	2	3	4	5	6	7	8	9	10
Vout (VDC)	11.88	11.76	11.64	11.52	11.4	11.28	11.16	11.04	10.92	10.8
Rt down (K $\Omega$ )	183.233	111.59	79.474	61.246	49.499	41.299	35.249	30.602	26.921	23.933
Trim up %	1	2	3	4	5	6	7	8	9	10
Vout (VDC)	12.12	12.24	12.36	12.48	12.6	12.72	12.84	12.96	13.08	13.2
Rt up (K $\Omega$ )	211.778	57.03	32.596	22.642	17.238	13.845	11.516	9.819	8.527	7.511

### AME60-15SVZ

Trim down %	1	2	3	4	5	6	7	8	9	10
Vout (VDC)	14.85	14.7	14.55	14.4	14.25	14.1	13.95	13.8	13.65	13.5
Rt down (KΩ)	616.5	304	199.833	147.75	116.5	95.667	80.786	69.625	60.944	54
Trim up %	1	2	3	4	5	6	7	8	9	10
Vout (VDC)	15.15	15.3	15.45	15.6	15.75	15.9	16.05	16.2	16.35	16.5
Rt up (KΩ)	124	61.5	40.667	30.25	24	19.833	16.857	14.625	12.889	11.5

### AME60-24SVZ

Trim down %	1	2	3	4	5	6	7	8	9	10
Vout (VDC)	23.76	23.52	23.28	23.04	22.8	22.56	22.32	22.08	21.84	21.6
Rt down (KΩ)	471.081	287.942	205.845	159.249	129.221	108.26	92.793	80.914	71.504	63.865
Trim up %	1	2	3	4	5	6	7	8	9	10
Vout (VDC)	24.24	24.48	24.72	24.96	25.2	25.44	25.68	25.92	26.16	26.4
Rt up (KΩ)	239.556	64.606	36.982	25.728	19.619	15.783	13.15	11.232	9.771	8.622

### AME60-48SVZ

Trim down %	1	2	3	4	5	6	7	8	9	10
Vout (VDC)	23.76	23.52	23.28	23.04	22.8	22.56	22.32	22.08	21.84	21.6
Rt down (KΩ)	471.081	287.942	205.845	159.249	129.221	108.26	92.793	80.914	71.504	63.865
Trim up %	1	2	3	4	5	6	7	8	9	10
Vout (VDC)	24.24	24.48	24.72	24.96	25.2	25.44	25.68	25.92	26.16	26.4
Rt up (KΩ)	239.556	64.606	36.982	25.728	19.619	15.783	13.15	11.232	9.771	8.622

**NOTE: 1.** Datasheets are updated as needed and as such, specifications are subject to change without notice. Once printed or downloaded, datasheets are no longer controlled by Aimtec; refer to [www.aimtec.com](http://www.aimtec.com) for the most current product specifications. **2.** Product labels shown, including safety agency certifications on labels, may vary based on the date manufactured. **3.** Mechanical drawings and specifications are for reference only. **4.** All specifications are measured at an ambient temperature of 25°C, humidity<75%, nominal input voltage and at rated output load unless otherwise specified. **5.** Aimtec may not have conducted destructive testing or chemical analysis on all internal components and chemicals at the time of publishing this document. CAS numbers and other limited information are considered proprietary and may not be available for release. **6.** This product is not designed for use in critical life support systems, equipment used in hazardous environments, nuclear control systems or other such applications which necessitate specific safety and regulatory standards other the ones listed in this datasheet. **7.** Warranty is in accordance with Aimtec's standard Terms of Sale available at [www.aimtec.com](http://www.aimtec.com).