

# LTC2947

## 30A Power/Energy Monitor with Integrated Sense Resistor

### DESCRIPTION

Demonstration circuit 2334A features the **LTC®2947**, a high precision power and energy meter with an internal 30A sense resistor. Three internal  $\Delta\Sigma$  ADCs ensure accurate measurement of voltage (0V to 15V) and current (–30A to 30A), while high bandwidth analog multiplication of voltage and current provides accurate power measurement (–450W to 450W) in a wide range of applications. Internal or external clocking options enable precise charge and energy measurements.

Efficiency loss and external part count are minimized by an internal  $300\mu\Omega$ , temperature compensated sense resistor, simplifying energy measurement applications while enabling high accuracy current measurement over the full temperature range.

All measured quantities are stored in internal registers accessible via the selectable I<sup>2</sup>C/SPI interface. The LTC2947 features programmable high and low thresholds for all measured quantities to reduce digital traffic with the host.

The operating voltage ranges are 4.5V to 15V for AVCC/DVCC and 1.8V to 5V for OVDD.

The current and voltage measurement inputs can be connected independently from each other to an external load and power supply. Thus, high side and low side sensing of positive and negative currents is possible. Voltage can

be measured across any nodes, for example, directly at the load terminals or at the power supply.

Current and power are internally accumulated for charge and energy measurement in two individual sets of registers. Each set of registers also includes a time base counter. This makes in total six accumulators, where each can be started, stopped and reprogrammed individually to provide maximum flexibility in many applications. The accumulators have a size of 48 bits for charge and energy and 32 bits for time.

Minimum and maximum values are stored and an over range alert with programmable thresholds minimizes the need for software polling. Data is reported via a standard I<sup>2</sup>C or SPI interface. Sleep mode reduces power consumption to less than 10 $\mu$ A.

The DC2334A was designed to be connected to the DC2026 or DC590 and controlled through the Linduino™-Sketch or QuikEval™ software. All configuration and measurement data can be written and read through the QuikEval interface, which provides a convenient way to evaluate the LTC2947.

**Design files for this circuit board are available at <http://www.linear.com/demo/DC2334A>**

LT, LT, LTC, LTM, Linear Technology and the Linear logo are registered trademarks and QuikEval and Linduino are trademarks of Linear Technology Corporation. All other trademarks are the property of their respective owners.

## QUICK START PROCEDURE

Various features of the DC2334A can be demonstrated by using Linear Technology's QuikEval Software. QuikEval is a USB-based product demonstration and data acquisition software meant to be used in conjunction with the DC590 that connects to individual daughter cards for specific Linear Technology products. This software can be found on Linear Technology's website at:

<http://ltspice.linear.com/software/ltcgev.exe>

Connect the DC590 to a PC using the USB cable provided with the DC590. Now, connect the DC590 to the DC2334A and apply power and load according to Figure 1.

Once setup is complete, run the QuikEval Software. QuikEval should auto-detect the DC2334A and provide the user with a control panel.

## INTERFACING THE DC2334A WITH THE DC2026

This board can also interface with the DC2026 Linduino board which is part of the Linduino Firmware Development Program. The Linduino Firmware Development Program provides users with convenient driver code, written in C, for a wide range of LTC products. Please see the Linduino web page for more details.

The DC2026 comes preloaded with a DC590 emulator firmware which allows for easy interfacing with QuikEval. Connection is done the same way as for the DC590 (Figure 1). QuikEval will launch the graphical user interface (GUI) as it would with the DC590. The DC2026 can also be used as a development platform, example software along with drivers can be found on the product landing page:

<http://www.linear.com/product/LTC2947>

NOTE: DC590 and DC2026 (Linduino) programmed with the DC590B sketch behave the same and so are fully compatible. This demo manual will mostly use the term DC590 but still it can be replaced by DC2026 (Linduino).

## DC2334A AS LINDUINO SHIELD

The DC2334A may be used as an Arduino/Linduino shield by stacking it on top of the DC2026 via connectors J5-J8.

In conjunction with a LCD Keypad Shield (e.g. from SainSmart.com, 20-011-901), this setup allows to run the DC2334A as a stand-alone power, charge and energy monitor without the need for a PC. A dedicated set of DC2334A, DC2026 with tailored Linduino sketch and a

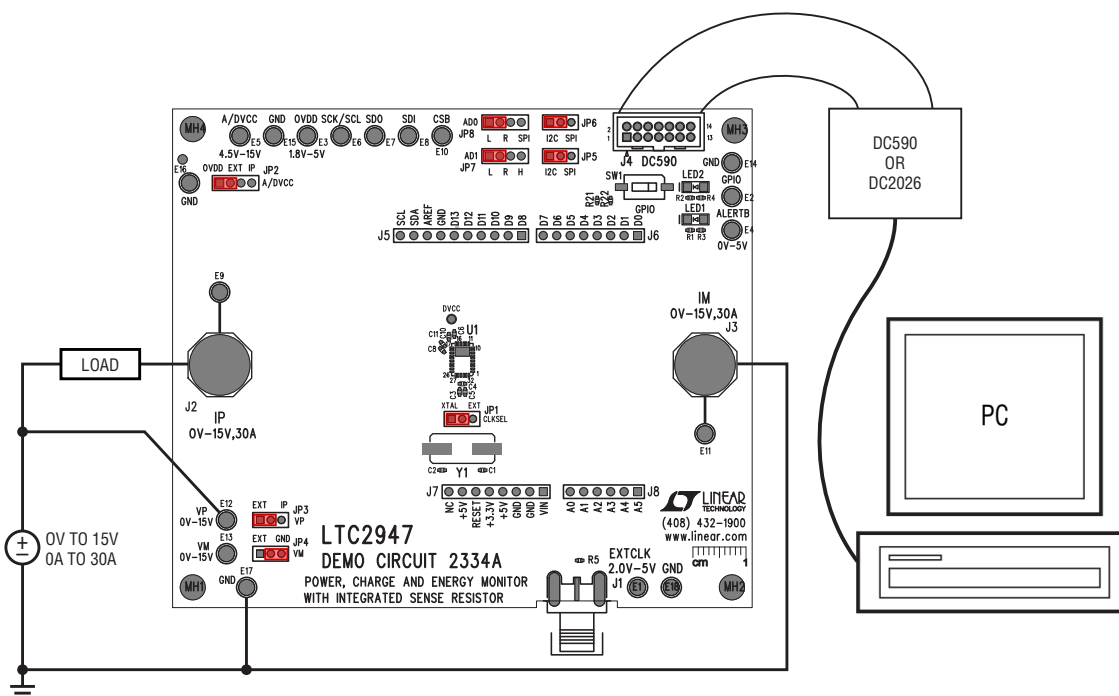

Figure 1. Hardware Bench Setup

## QUICK START PROCEDURE

display can be ordered at the product landing page:

<http://www.linear.com/product/LTC2947>

The tailored Linduino sketch by itself can be downloaded from that page.

In the shield configuration, DC2334A must be configured for I<sup>2</sup>C operation mode, see JP5-JP8 and Figure 2.

If desired, DC2334A connected as a shield on top of Linduino (DC2026) preloaded with the DC590 sketch can still be controlled by the LTC2947 GUI. As QuikEval is not able to identify the DC2334A in this configuration, the GUI has to be installed manually. The following two files must be downloaded from the Linear web page

<http://ltspace.linear.com/quikeval/ins2947.msi>

<http://ltspace.linear.com/quikeval/setup2947.exe>

and placed into one local folder. Install the software by executing setup2947.exe. Afterwards the GUI software can be started from the Windows Start Menu:

Start Menu\Programs\Linear Technology\LTC2947

Also see the Troubleshooting Connection Errors section for more details on Linduino shield operation.

LTC2947's GPIO and ALERTB pins are connected to Linduino pins D2 and D3 as shown in Figure 3.

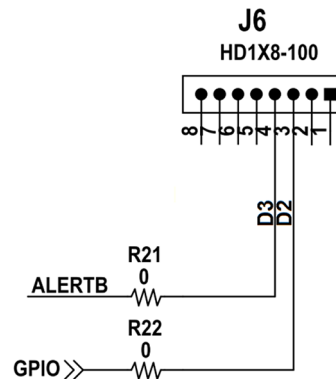

Figure 3. GPIO/ALERTB on Linduino Shield Header J6

The Linduino DC590 sketch pulls these pins low by default, so it is not possible to evaluate GPIO and ALERTB behavior in this configuration.

This does not affect evaluation of the LTC2947 using the software provided by the Linduino Firmware Development Program. The DC2334A sketch and the LTC2947 library files can take full advantage of the GPIO and ALERTB connected to the Linduino IO pins.

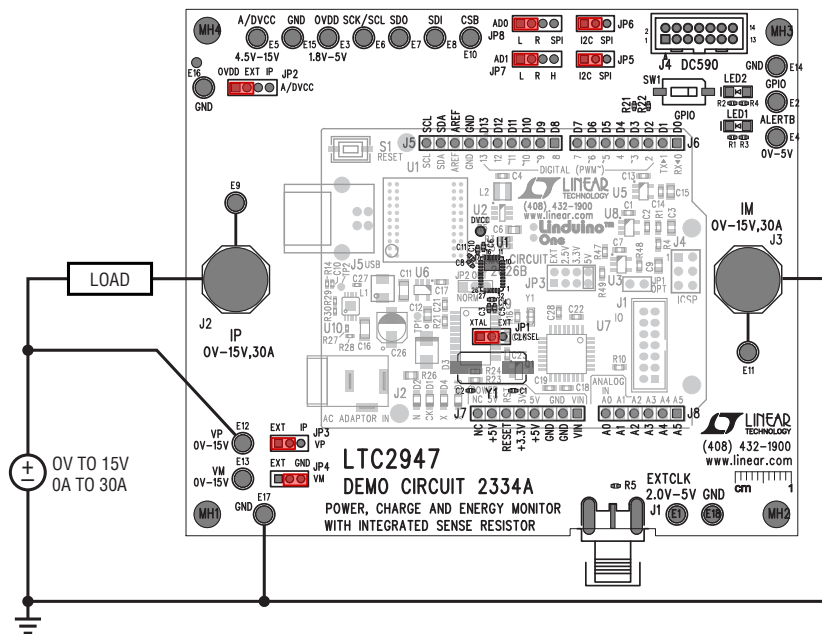

Figure 2. Linduino Shield Style Hardware Bench Setup

## HARDWARE SETUP

### JUMPER AND CONNECTORS

#### Jumper Settings

It is not recommended to change any jumper settings while LTC2947 is powered up, e.g. while any of the supplies to A/DVCC, OVDD is applied.

**JP1 (CLKSEL):** Select between external clock generator (EXT) and 4MHz crystal oscillator (XTAL, default). If TBCTL is set to internal 1MHz clock the setting of JP1 is ignored.

**JP2 (A/DVCC):** Select AVCC supply input. AVCC is shorted to DVCC by resistor R9. The supply input can be

1. IP in case of high side current sensing where IP is always > 4.5V (max. 15V)
2. EXT for an external power supply of 4.5V to 15V connected to turret AVCC
3. OVDD (default) for an on-board supply of typ. 4.6V generated by a LDO from 5V OVDD supplied by DC590/DC2026 (in this case the LDO only serves as a protection device and is not necessary for normal operation, see appendix for details.)

For applications where the LTC2947 should also measure its own supply current, connect AVCC externally to IM, and place jumper to EXT.

**JP3 (VP):** Select connection of VP. Can be either EXT (default) for external connection to turret E12 (VP) or IP for onboard connection to IP.

**JP4 (VM):** Select connection of VM. Can be either EXT (default) for external connection to turret E13 (VM) or GND for onboard connection to ground.

**JP5, JP6 (SPI/I<sup>2</sup>C):** Select between SPI or I<sup>2</sup>C (default) serial mode. Both jumpers must be set to the same position for proper operation. For SPI mode, the jumper JP8 (AD0) must be set to SPI (OVDD).

**JP7, JP8 (AD0, AD1):** I<sup>2</sup>C address selection or SPI mode operation.

1. For SPI mode set JP8 (AD0) to SPI (OVDD) and set JP7 (AD1) to R as AD1 serves as the chip select input (CSB).

2. For I<sup>2</sup>C mode set JP8 (AD0) to L or R and JP7 (AD1) to L, R or H to select between the following possible I<sup>2</sup>C slave addresses:

**Table 1. I<sup>2</sup>C Slave Address Select. Default is L, L (0x5C).**

JP8 (AD0)	JP7 (AD1)	SLAVE ADDRESS
L	L	0x5C
L	H	0x5D
L	R	0x5E
R	L	0x64
R	H	0x65
R	R	0x66

It is not possible to switch between I<sup>2</sup>C/SPI while the LTC2947 is powered up!

NOTE: If the DC2334A configured to SPI mode is not controlled by the DC590/Linduino but by a custom controller board it must be ensured that the CSB line is actively driven high in the idle state and low when a transaction takes place. For controllers that don't have a push-pull output but an open-drain buffer the CSB line must be pulled up by a resistor with a recommended maximum value of 20k which will safely override the 100k pull-down resistor on the DC2334A in the static state. Depending on the parasitic capacitance of the CSB line and the SPI timing a smaller resistor value may be necessary. If the open drain buffer is able to sink enough current to pull low a 330Ω resistor, JP7 (AD1) may be set to H to use DC2334A's R10 as the pull-up resistor.

#### Connector Description

**J1/E1 (EXTCLK):** External clock input. Range 100kHz to 25MHz, low level 0V to 0.4V, high level 2V to 5V.

**J2/E9 (IP), J3/E11 (IM):** Positive (IP) and negative (IM) input/output of high current path. Use J2/3 for high currents up to 30A or turrets E9/11 to ease connection in case of low currents up to 4A.

**J4 (DC590):** Signal/power connector to DC590 or DC2026.

**J5-J8:** Connectors to allow stacking of the DC2334A on top of an Arduino/Linduino.

## HARDWARE SETUP

### Turrets

**E2 (GPIO) – LED2:** General Purpose Input/Output. Lights up green when pulled low. Default is input.

**E3 (OVDD):** Power supply for digital interface. For typical operation it is connected via J4 to a 5V supply from a DC590/DC2026. In case the user connects another controller board, a supply voltage between 1.8V to 5V can be connected to this turret. For an OVDD supply < 4.8V, a suitable voltage input must be connected to AVCC/DVCC. See jumper JP2 (A/DVCC) or turret E5 (A/DVCC).

**E4 (ALERTB) – LED1:** Alert Output. Pulled low on an ALERT condition (default on start-up). Can also be monitored on the ALERT turret. LED1 lights up red if ALERTB is pulled low.

**E5 (A/DVCC):** Analog and digital supply input. AVCC and DVCC are shorted onboard by zero ohm resistor R9. See JP2 for possible supply options.

**E6 (SCL/SCK):** Serial clock input for I<sup>2</sup>C and SPI interface.

**E7 (SDO):** Serial data output for I<sup>2</sup>C and SPI interface. In I<sup>2</sup>C mode this signal is shorted to SDI by jumper JP5 to form the SDA signal.

**E8 (SDI):** Serial data input for I<sup>2</sup>C and SPI interface. In I<sup>2</sup>C mode this signal is shorted to SDO by jumper JP5 to form the SDA signal.

**E10 (CSB):** Chip select input for SPI interface. In I<sup>2</sup>C mode it is part of the slave address configuration.

**E12 (VP), E13 (VM):** Positive (VP) and negative (VM) input of voltage ADC. Measurement range is 0V to 15V. Make sure jumpers JP3 (VP) and JP4 (VM) are both set to EXT before applying any voltage sources.

**E14, E15, E16, E17, E18 (GND):** Ground turrets.

### POWERING THE DC2334A

The DC2334A supports many different supply options. In the default configuration OVDD is supplied by 5V from DC590. For this reason, JP6 (VCCIO) on the DC590 must be set to 5V. If using a DC2026A, jumper JP1 must be shorted (which is the default if PCB trace JP1 wasn't cut). For the DC2026B (and newer versions), set jumper JP3 to 5V (default). See the latest demo manual of those boards for details. If the supply from those boards is disabled or

a user specific board is used, any voltage between 1.8V and 5V can be connected to OVDD.

A/DVCC can be supplied by IP, externally or on-board which is the default, see JP2. If A/DVCC and OVDD are not supplied from the same source, make sure OVDD reaches its minimum operating voltage of 1.8V before A/DVCC reaches its undervoltage lockout threshold of 4.5V. In the default setting of JP2, the power sequence timing is inherently met.

### RINGING

It comes as a surprise to many that seemingly innocent acts, such as making a connection to a live supply, may destroy an IC due to ringing. This ringing is an effect of the LC oscillator that is formed by the cable inductance, the supply decoupling capacitor and other parasitics. The longer the cable that is used to power the board, the bigger its inductance and so is the energy that is stored in it when hot-plugging. Larger inductance also means low frequency of the LC oscillator, so the ringing lasts longer. Under particular conditions, the ringing can reach more than two times the input voltage and last several microseconds, enough to exceed the absolute maximum ratings of the part and destroy it. Figure 4 shows this effect when hot-plugging A/DVCC to a 15V power supply with a 50cm cable. The maximum amplitude is over 30V.

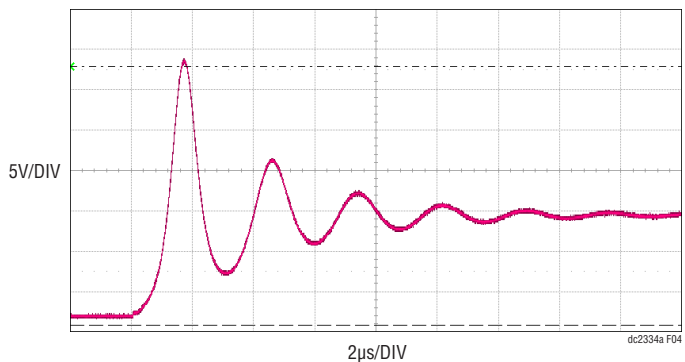

**Figure 4. Ringing on A/DVCC when Hot-Plugging to a 15V Supply with a 50cm Cable**

Avoiding ringing is easily achieved by first wiring up the board and then slowly ramping up the supplies. If OVDD and A/DVCC are supplied separately, make sure OVDD is turned on first.

## HARDWARE SETUP

### CURRENT/VOLTAGE SENSE OPTIONS

The DC2334A allows for evaluation of different current sense/voltage measurement options.

### High Side Current Sense

Figure 5 shows a typical application of LTC2947 where the current from the external power supply is sensed on the high side. Voltage is measured between IP and ground (JP3 set to IP, JP4 set to GND) or by an external connection (JP3, JP4 set to default position EXT), for example, between the supply or the load terminals.

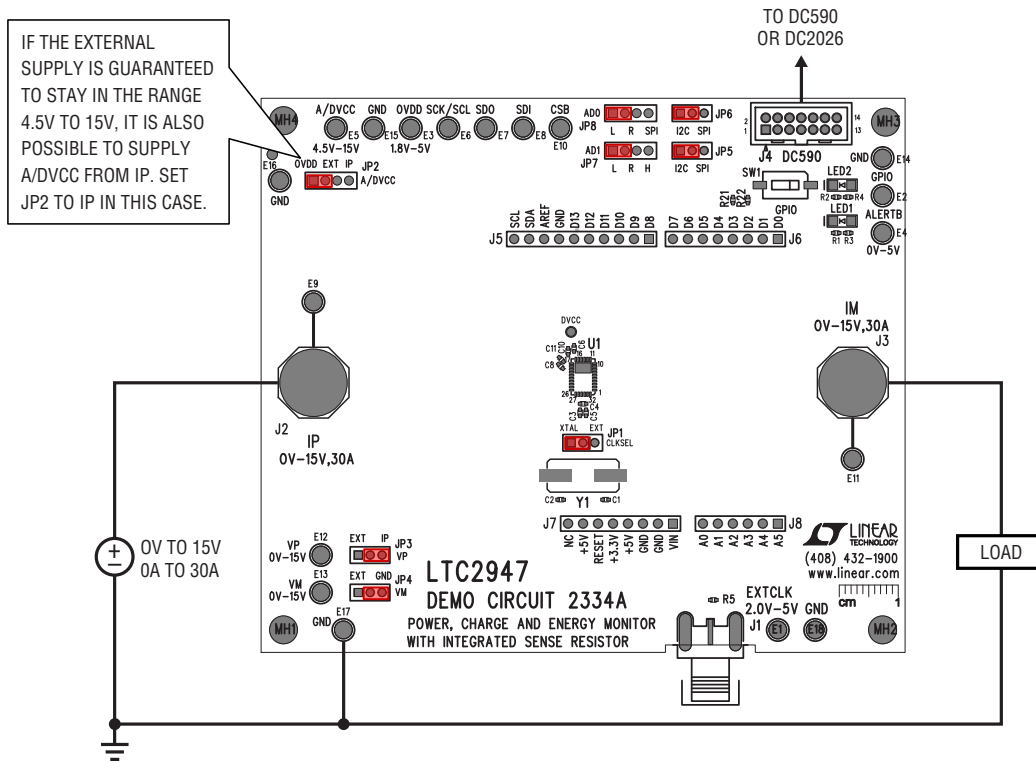

Figure 5. DC2334A Powered by DC590/DC2026 and Configured for High Side Sensing

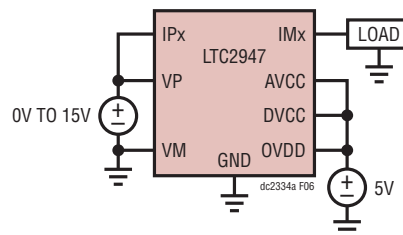

Figure 6. LTC2947 Powered by Single 5V Supply and Configured for High Side Sensing

## HARDWARE SETUP

### Low Side Current Sense

The following figure shows a typical application of the LTC2947, where the current from the external power supply is sensed on the low side. Voltage is measured between the positive supply terminal and ground (JP3 set to EXT, JP4 set to GND).

It is also possible to sense the voltage between the load terminals by setting JP3, JP4 to EXT and applying the proper connection to VP, VM turrets (E12, E13).

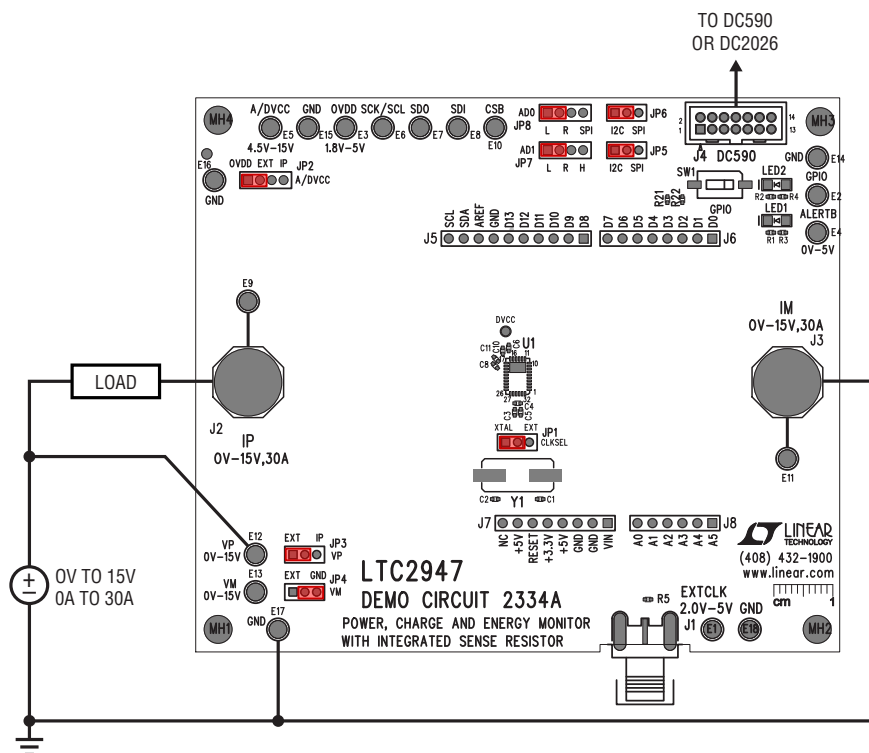

Figure 7. DC2334A in Low Side Sensing Configuration

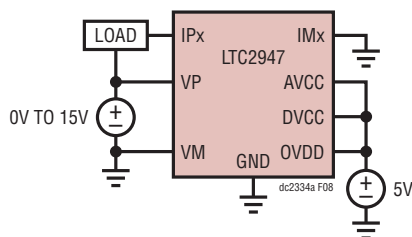

Figure 8. LTC2947 in Low Side Sensing Configuration

# DEMO MANUAL DC2334A

## HARDWARE SETUP

### External Oscillator

An external oscillator may be connected to J1 or turrets E1 (EXTCLK), E18 (GND). The maximum low level voltage

is 0.4V and the minimum high level voltage is 2V. The maximum recommended operating voltage is 5V and is independent from any of the supply pins.

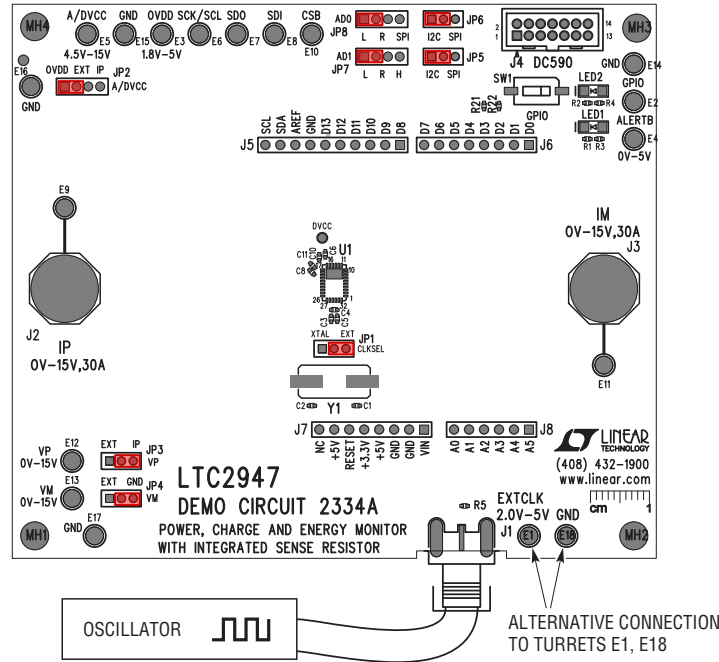

Figure 9. DC2334A in External Clock Operation

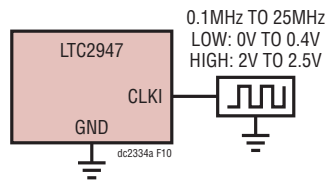

Figure 10. LTC2947 in External Clock Operation

## PCB LAYOUT

### PCB LAYOUT VS PERFORMANCE

To get the best performance out of LTC2947, it is important to follow some layout rules, which were mostly followed on this demo circuit. At some point, a trade-off between flexible evaluation of different application scenarios and the best possible layout and compact PCB at reasonable costs

had to be done. For this reason, the present demo circuit does not claim to have the perfect one-and-only layout but one that is reasonable for evaluation and showcasing the LTC2947's high performance.

For general layout considerations, please consult the data sheet of the LTC2947.



## DC2334A SOFTWARE USER INTERFACE

The DC2334A software user interface was designed to allow users to quickly evaluate the LTC2947. The user has the ability to plot/monitor voltage, current, power, charge and energy, as well as to set fault thresholds and enable, disable and clear alerts. Once the graphical user interface (GUI) is started, it will automatically connect to the DC590/DC2026 (Figure 11) and read out all the register values from the LTC2947.

After the connection is established, the mouse pointer will automatically jump to some controls that show message bubbles which provide information about basic operation steps (see Figure 12, Figure 13, Figure 14) which are:

- Starting continuous conversion
- Enabling Register Auto Read (data transfer from device to PC)
- Clearing device's accumulators and trackers and GUI's plots

The LTC2947 GUI is split into several sub-windows that can be rearranged and even detached from the main window by dragging the title, moving around and dropping to a new position. Some sub-windows are hidden and can be shown by enabling them in the View menu. All this allows the GUI to be adjusted to any screen size and to show only

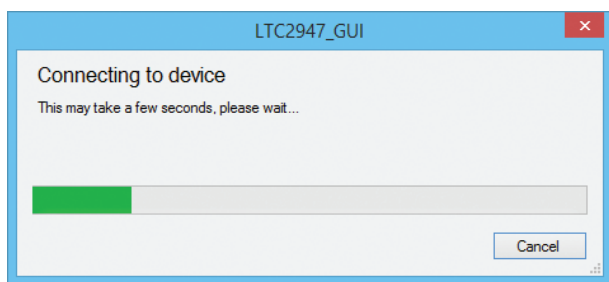

Figure 11. GUI Connection Progress Window

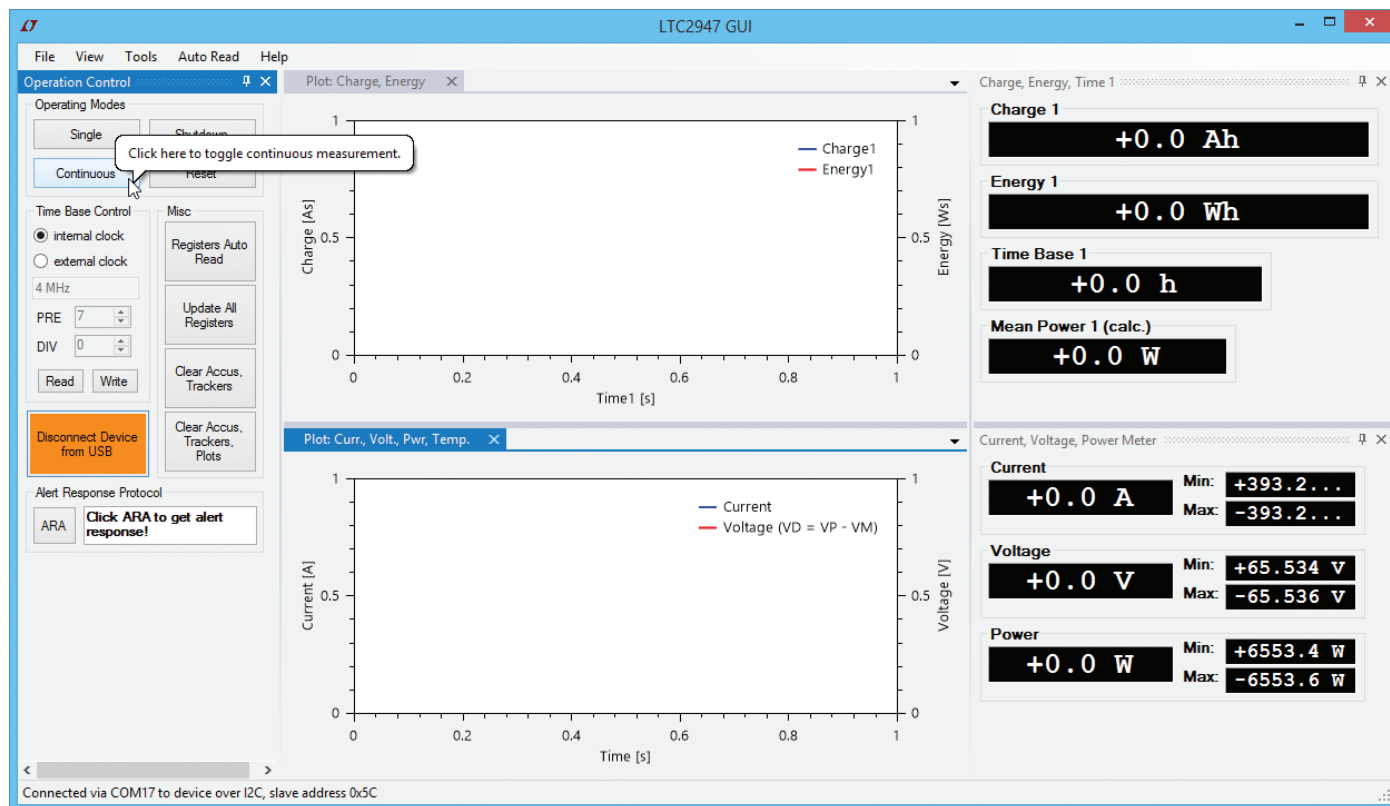

Figure 12. GUI Overview, Continuous Measurement Notice

## DC2334A SOFTWARE USER INTERFACE

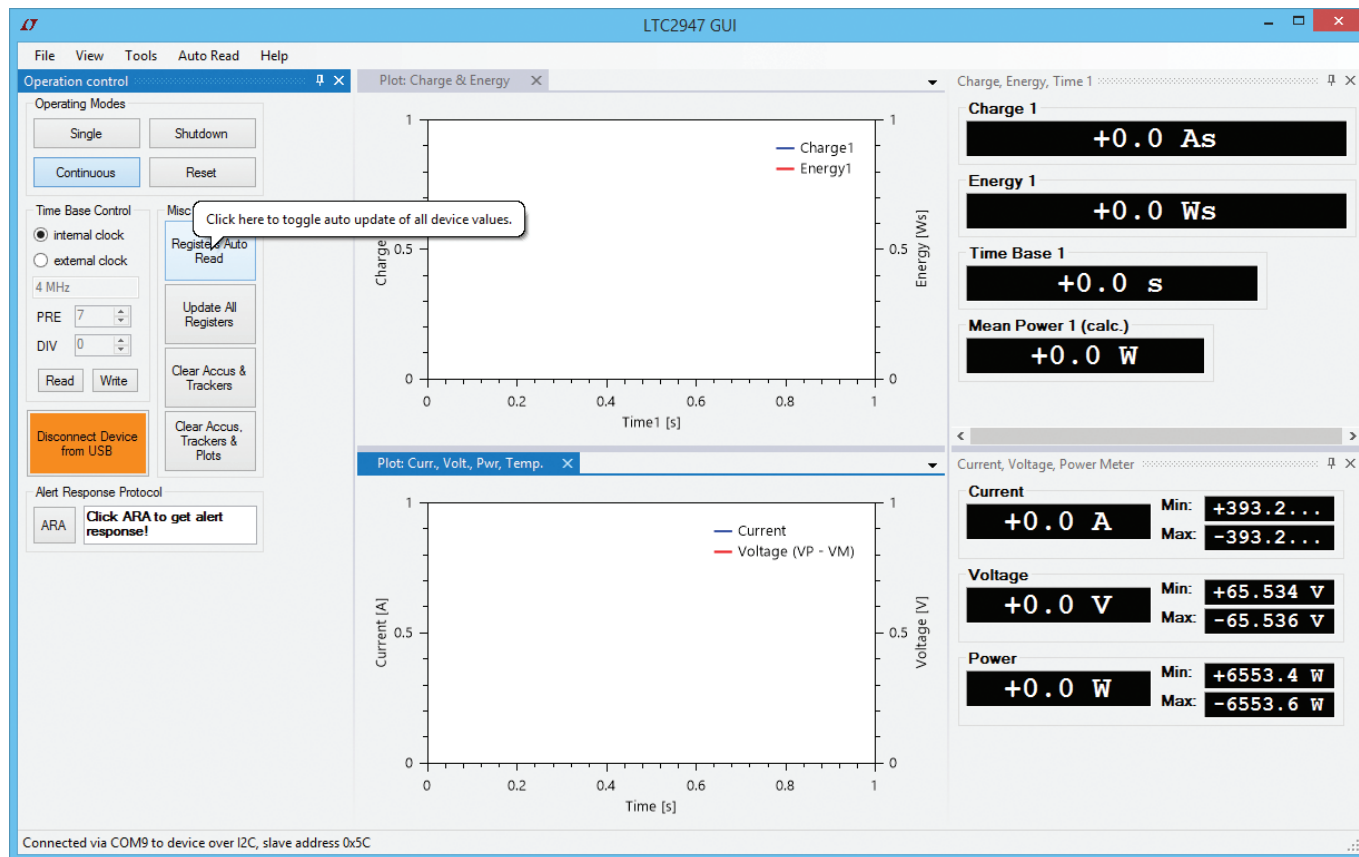

Figure 13. GUI Overview, Enable Data Collection Notice

the information that is of interest for a given application without overwhelming the user with the large feature-set of the LTC2947.

Any custom GUI layout may be set as the default (View → Set Default Layout), stored to a specific file (View →

Save Layout...) or reloaded (View → Get Default Layout or Load Layout...). The default layout will always be reloaded on start-up. The GUI may be reset to the factory default layout by View → Reset Default Layout.

# DC2334A SOFTWARE USER INTERFACE

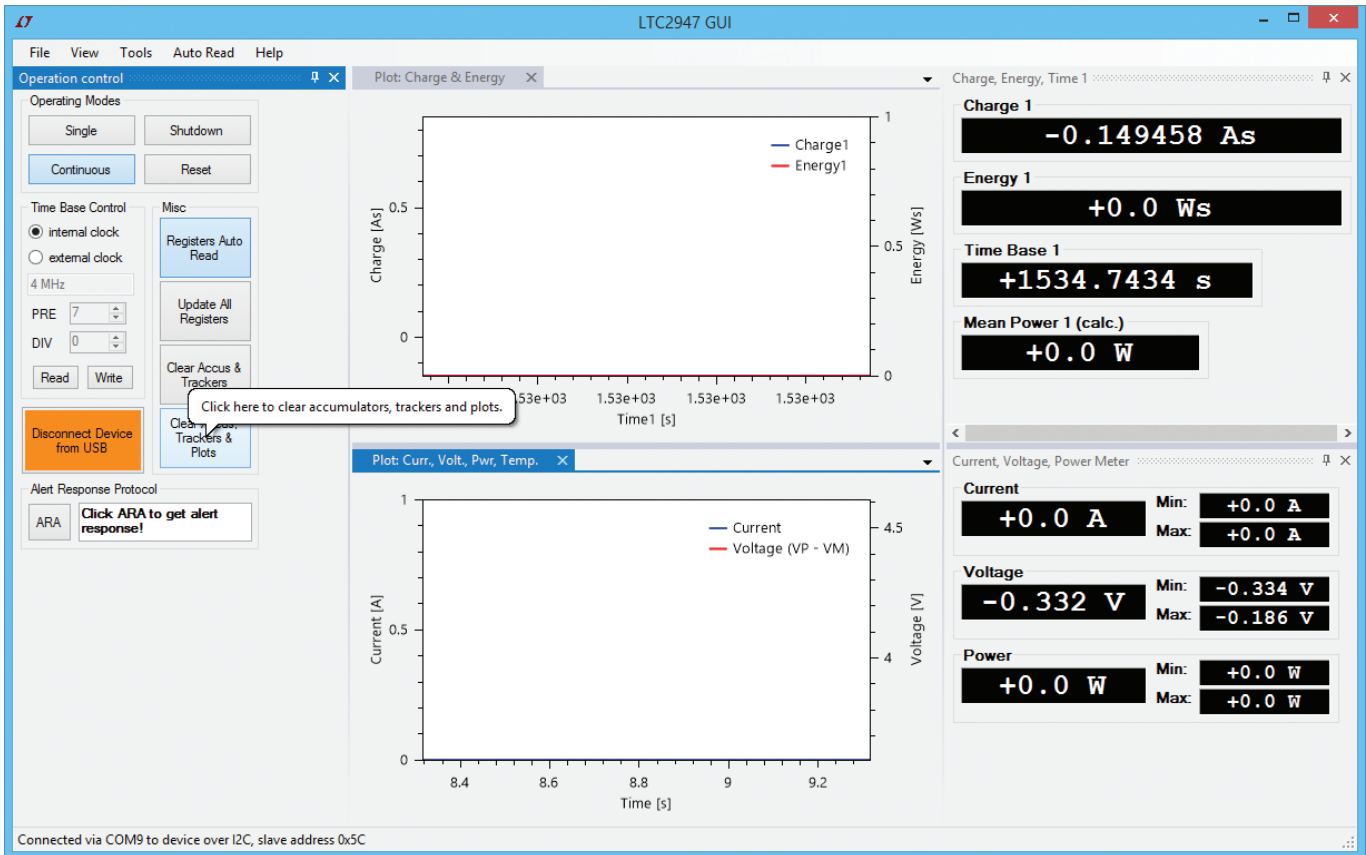

Figure 14. GUI Overview, Clear Accumulators, Trackers and Plots Notice

## DC2334A SOFTWARE USER INTERFACE

### OPERATION CONTROL

The Operation Control functions are:

1. Connect/Disconnect Device via USB (DC590/DC2026)
2. Enable/Disable Continuous measurement
3. Make Single conversion
4. Shutdown Device
5. Reset Device
6. Time Base Control to set internal or external clock frequency including calculation of PRE/DIV values for a given clock (see also Tools Menu section)
7. Enable/Disable Register Auto Read. If enabled data is automatically transferred from device to PC every 500ms (default), see section Auto Read Menu
8. Manually Update All Registers (manually transfer all data from device to PC)
9. Clear Accumulator and Tracking registers

10. Clear Accumulator and Tracking registers and reset all data in all plot windows
11. For I<sup>2</sup>C only: Send ARA (Alert Response Address) and get response

In case the GUI is not connected to the device (Figure 15, left) all controls but the green Connect Device via USB button are disabled. Hit the green button to establish the connection.

A window (Figure 16) is shown allowing to specify the COM port of the DC590/DC2026, serial slave interface

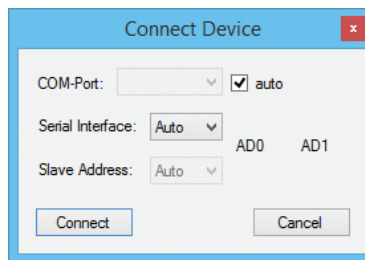

Figure 16. Connect Device Configuration Window

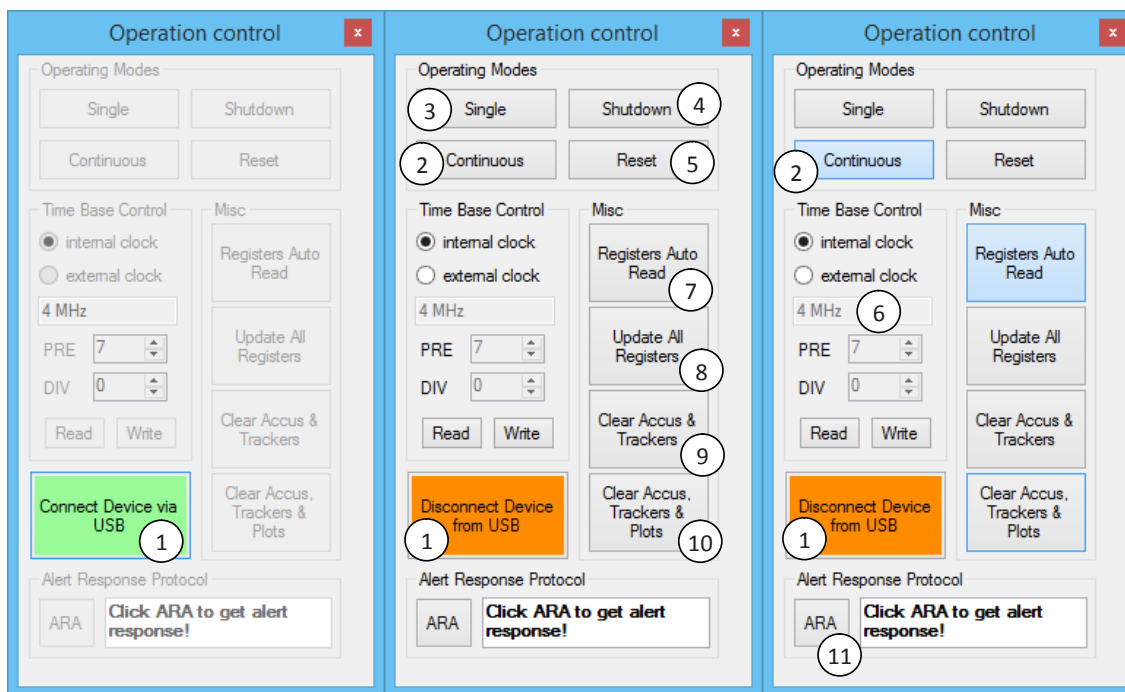

Figure 15. GUI Operation Control Functions

## DC2334A SOFTWARE USER INTERFACE

configuration and slave address (for I<sup>2</sup>C only). In the default setting the GUI will automatically try to determine all the settings.

Once the connection is established all sub-windows are enabled and the GUI will be ready to control the device. The serial interface configuration will be reported in the Status Bar of the GUI. As an example Figure 17 shows this for I<sup>2</sup>C (upper) and SPI (lower) interface configuration.

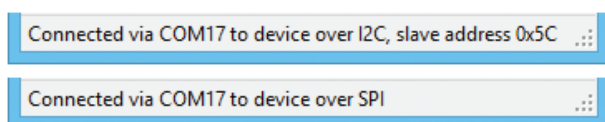

Figure 17. Serial Interface and COM Connection Info

Continuous, Shutdown and Register Auto Read are two-state buttons; meaning, they change color if they are enabled (highlighted, e.g. blue) or disabled (default e.g. grey). Figure 15, right, shows this in the case of a running continuous measurement and enabled Register Auto Read.

Shutdown will put the device into a low-power state. Any serial transaction to the device will wake it up immediately. For this reason, Register Auto Read will always be disabled before issuing the shutdown command to the device. The GUI will report this as shown in Figure 18.

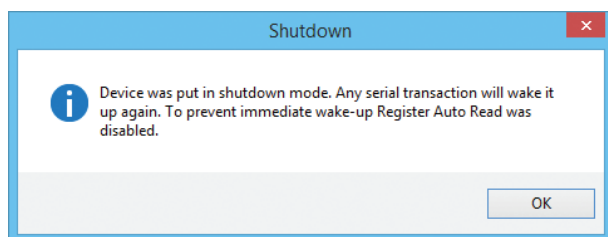

Figure 18. Shutdown Notice About Disabling the Register Auto Read

Most of the GUI controls will take effect immediately once they are clicked or a value is entered. The only exception is the Time Base Control. Any changed configuration and entered value will only take effect after the Write button is clicked. If Register Auto Read is enabled, the Time Base Control values won't be updated as long the user is making changes to it. Any changed values will be discarded and replaced by the current device values if the Write button is not clicked. If Register Auto Read is disabled, a click on the Read button will get the current values from the device.

By clicking on ARA within the Alert Response Protocol section, the GUI will send the alert response address to the I<sup>2</sup>C bus. All present slave devices that were issuing an alert will respond with their slave address. If more than one device is responding, the lowest slave address wins. Figure 19 shows all responses the GUI may show after clicking on the ARA button.

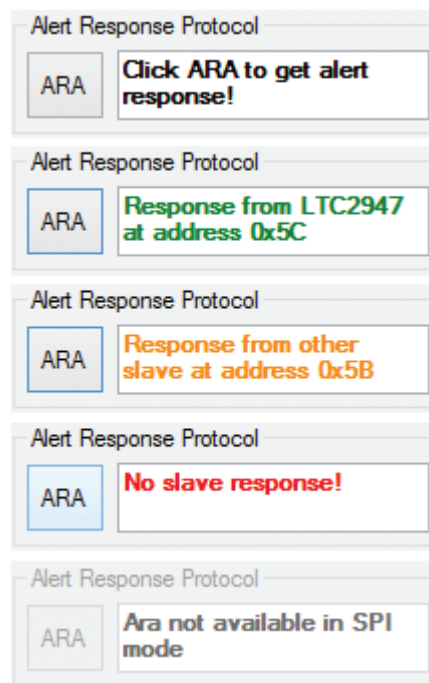

Figure 19. Possible ARA Responses

## DC2334A SOFTWARE USER INTERFACE

### MULTIMETERS

The GUI shows all measurement quantities in digital multimeter styles. By default, only Current, Voltage and Power, Charge 1, Energy 1 and Time Base 1 are shown. In the View menu, the second accumulators (Charge 2, Energy 2, Time Base 2), Chip temperature and DVCC supply voltage can be made visible. See Figure 20 for all available multimeters.

Accumulated quantities are shown in units of h, Wh, Ah by default. The units can be changed by right mouse clicking on a specific multimeter and selecting a different unit from the opened context menu. The Charge, Energy, Time 1 multimeter in Figure 20 shows the context menu for unit selection.

The Charge, Energy, Time multimeters include a calculated mean power display. This value is calculated by the GUI using Energy E and Time Base TB from the device and equals  $E/TB$ .

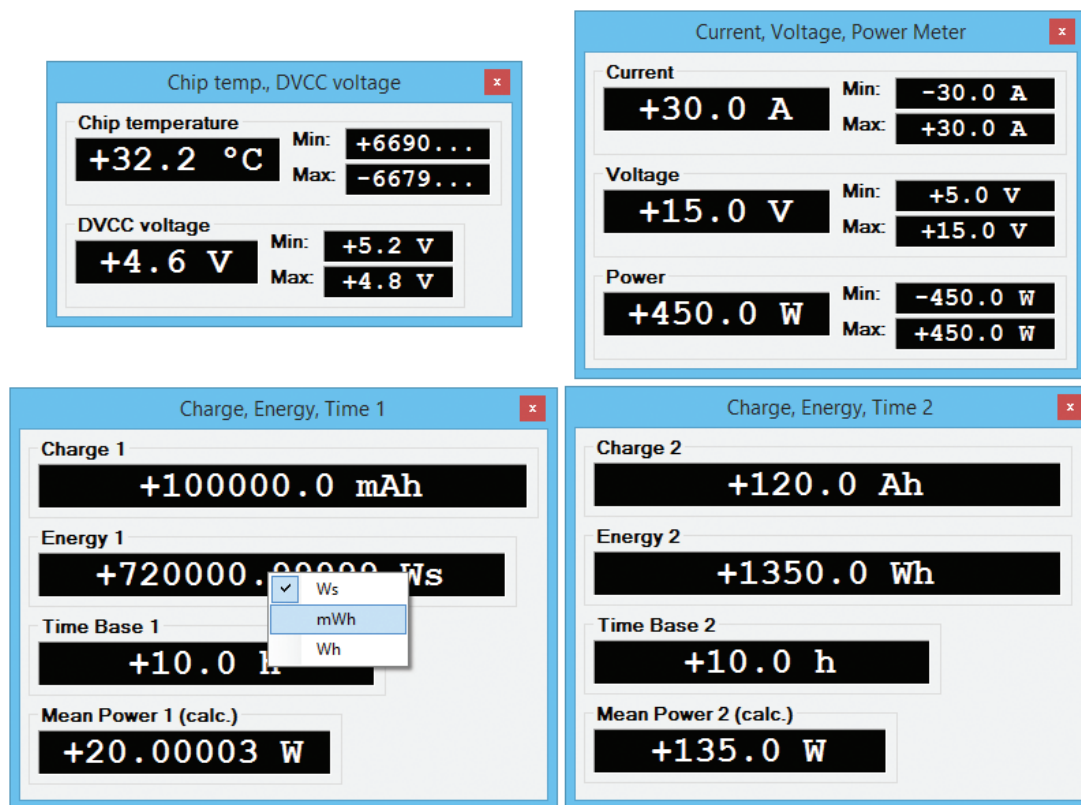

Figure 20. GUI Multimeters for All Measurement Quantities

## DC2334A SOFTWARE USER INTERFACE

### PLOTS/DATA COLLECTION

The GUI provides two separate plots of collected data. One for current, voltage, power and temperature, the other for charge and energy over time. The plots will collect data whenever the device is in continuous measurement mode and measurement results are read from the device either by a manual read (e.g. Update All Registers or read via the register map) or by the Registers Auto Read function.

The basic steps to start data collection in Register Auto Read mode are:

- Set continuous conversion
- Enable Register Auto Read
- Optional: clear device’s accumulators and trackers and GUI’s plots

The order of those steps does not matter. Any time Continuous and Auto Register Read are activated, data collection is performed automatically.

By default, the plots show Voltage (red) and Current (blue) as well as Energy 1 (red) and Charge 1 (blue). Other data is hidden but may be enabled via the plot’s context menu which can be shown by right mouse clicking in any area within the plot. The sub-menu Channels will list any available data, see Figure 22.

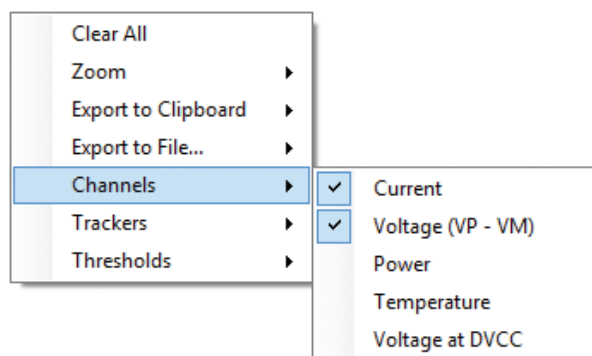

Figure 22. Plot’s Context Menu, Channel Selection

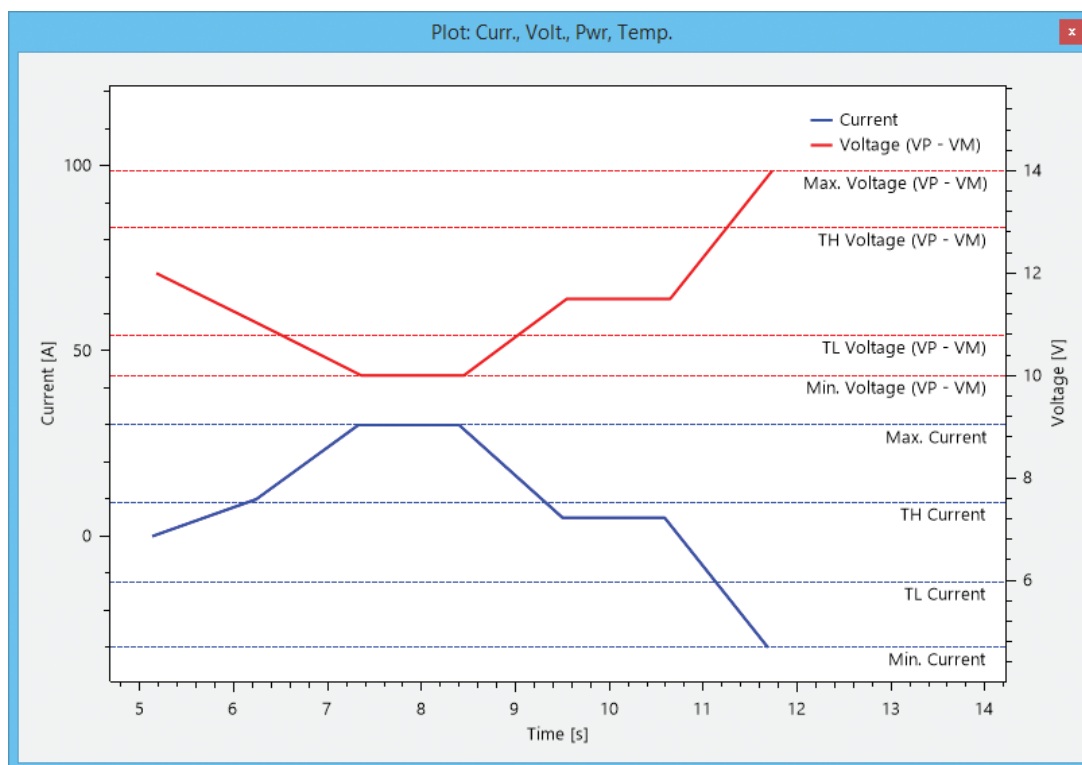

Figure 21. GUI Plot of Voltage and Current Including Trackers and Thresholds

## DC2334A SOFTWARE USER INTERFACE

The plot context menu's functions are:

1. Clear All plot data
2. Zoom
3. Export plot data to Clipboard as CSV (Comma-separated values)
4. Export plot data to File in CSV format
5. Display/Hide Channels
6. Display/Hide Trackers (minimum/maximum values, not available for accumulated quantities like charge, energy)
7. Display/Hide Thresholds (low/high alert values)

3. Pan vertically and horizontally by right mouse clicking the plot area. This will pan the first visible channel only
4. Show label with data point values by left mouse click on a data line
5. Zoom vertically by rotating mouse wheel over the Y-Axis
6. Zoom horizontally by rotating mouse wheel over the X-Axis
7. Zoom vertically and horizontally by rotating mouse wheel over the plot area. This will zoom the first visible channel only

### Plot Zoom Fit

The plots may be zoomed in different ways. Zoom Fit All will fit all data except trackers and thresholds into the plot area. Zoom Fit X-Axis/Y-Axis will do the same for X/Y axis only. Zoom Fit Limits will again fit all axes but will include trackers and thresholds. The latter is helpful to show the device's thresholds which may be far above/below typical measurement values. The low thresholds, for example, are set to the most negative register value. In case of power the threshold's low (PTL) default value is  $-6553.6$  Watts.

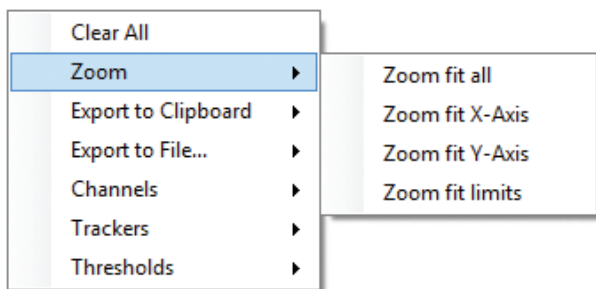

Figure 23. Plot's Context Menu, Zoom

### Plot Pan, Zoom, Labels

The following mouse gestures are supported by the plot.

1. Pan vertically by right mouse clicking the Y-Axis
2. Pan horizontally by right mouse clicking the X-Axis

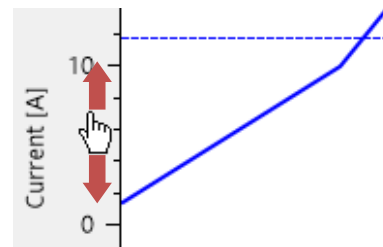

Figure 24. Plot Pan Vertically by Right Mouse Clicking on Y-Axis

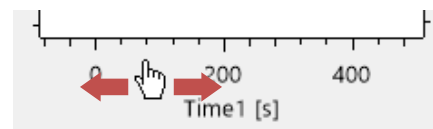

Figure 25. Plot Pan Horizontally by Right Mouse Clicking X-Axis

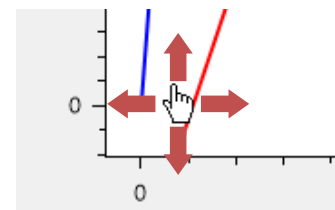

Figure 26. Plot Pan Vertically and Horizontally by Right Mouse Clicking in Plot Area

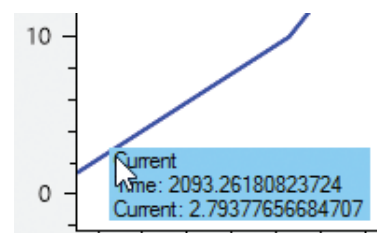

Figure 27. Plot Show Label by Left Mouse Clicking on Data Line

dc2334af



## DC2334A SOFTWARE USER INTERFACE

### Change Thresholds on the Fly

Once the thresholds are visible, they can be dragged by the mouse and set to a new desired value. Dragging is indicated by a bold threshold line in the plot, see Figure 28. The new value is written to the device and will take effect immediately.

The threshold's visibility may be changed in the context sub-menu Thresholds.

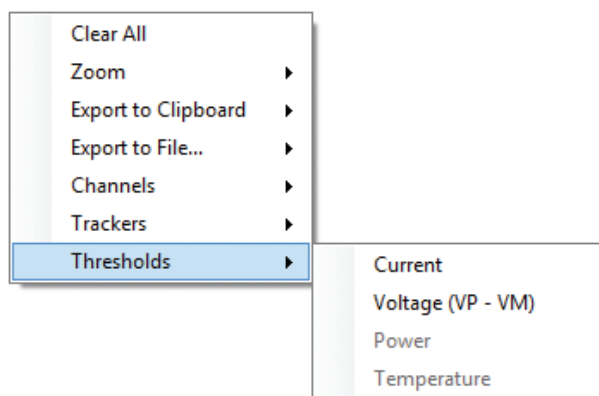

Figure 29. Plot's Context Menu, Thresholds

### Plot Trackers

The trackers show the minimum and maximum values of the non-accumulated quantities (Current, Voltage, etc.). Overwriting trackers is not possible from the plot window but can be done in the register map control, see the Register Map section.

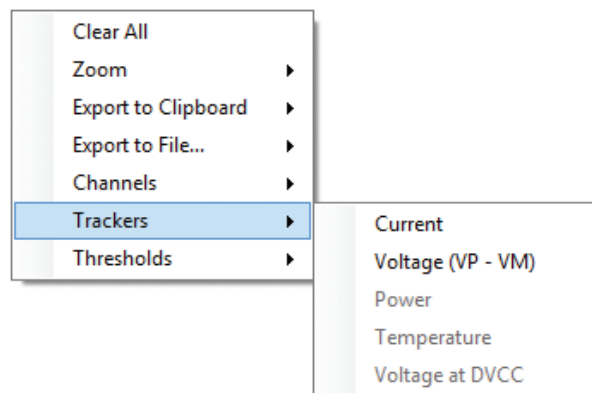

Figure 30. Plot's Context Menu, Trackers

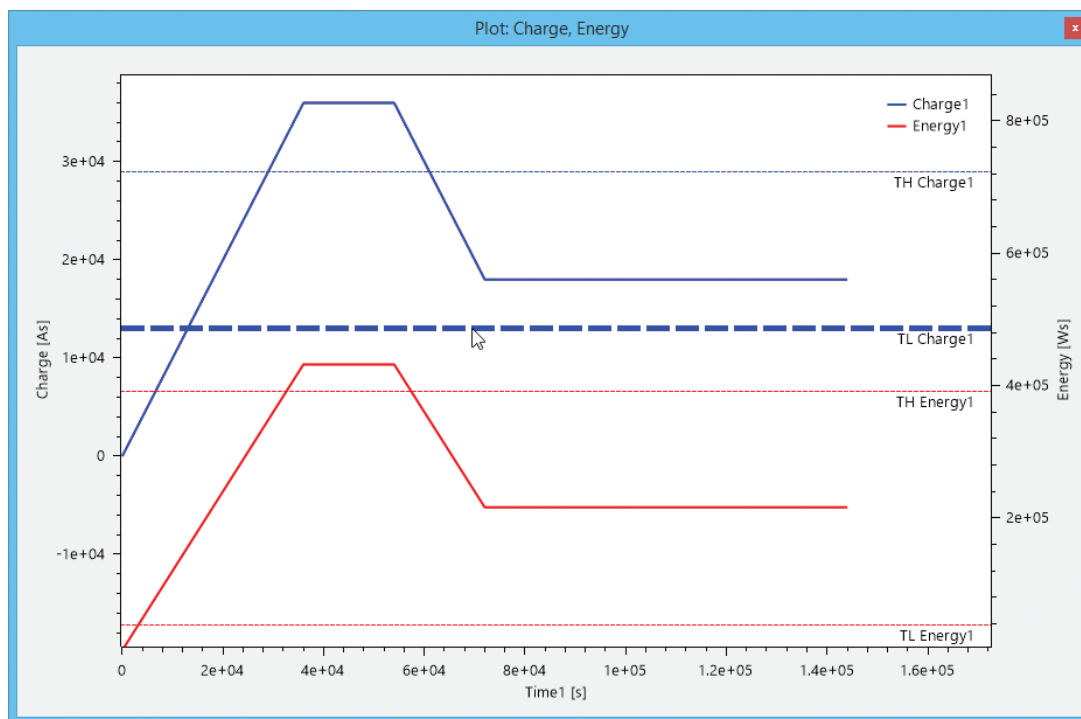

Figure 28. Plot: Charge, Energy. Dragging of C1TL Indicated by Bold Threshold Line

## DC2334A SOFTWARE USER INTERFACE

### Export Plot Data

There are two ways to export the collected data as CSV (comma-separated values) from the plot. Export to Clipboard will copy the selected channel data to the clipboard to be able to paste it to some other program like MS Excel. Export to File allows the user to choose a file to store the data. See following Figure 31, Figure 32.

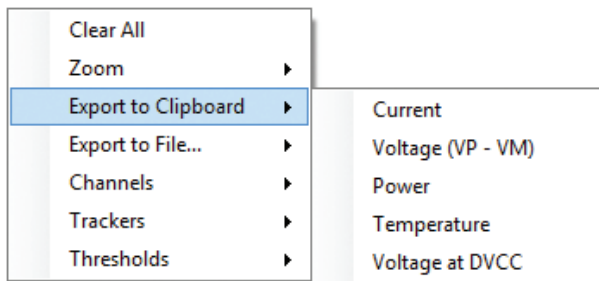

Figure 31. Plot's Context Menu, Export to Clipboard

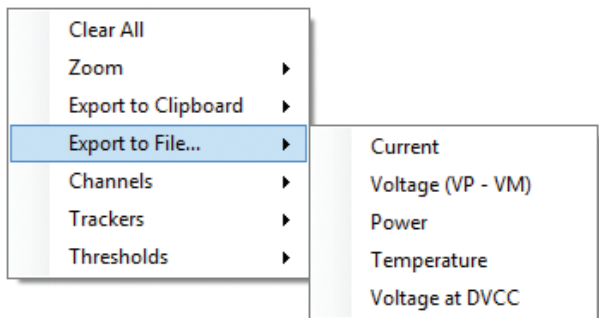

Figure 32. Plot's Context Menu, Export to File

The CSV data can be easily imported into MS Excel using the Text Import Wizard as shown in Figure 33 and Figure 34.

### Plot Time Axis

All data is plotted over time, but the meaning of time differs for the two plots.

Non-accumulated quantities (current, voltage, etc.) are plotted over real time of the PC. The time starts when the first values are read from the device while in continuous mode or when the plots are cleared.

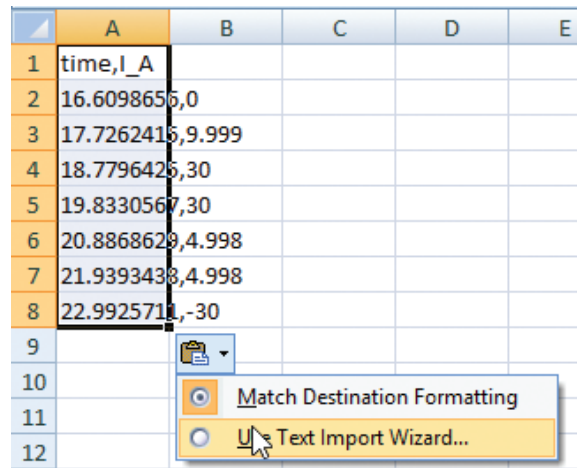

Figure 33. Import CSV into Excel by its Wizard

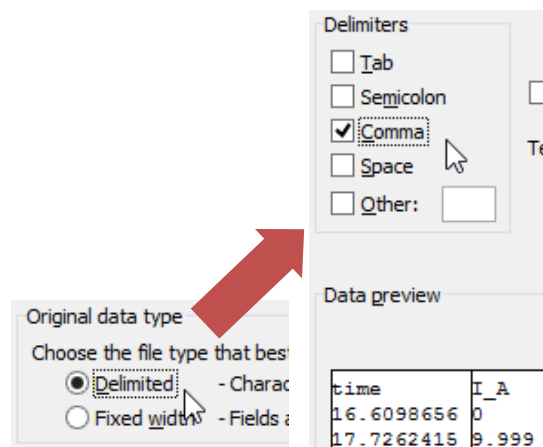

Figure 34. Excel Text Import Wizard Settings for CSV

The accumulated quantities charge and energy, are plotted over the corresponding time base. Whenever a triplet of charge, energy and time of any of the two accumulator sets is read, it is added to the plot. Charge, energy and time may be modified during measurement either by a direct write or by issuing the Clear (Clear Accus, Trackers) command. Doing so will result in a jump in the plot. If the time base after this modification is lower than the last time read, the plot will even go backwards. If this behavior is not desired, it is recommended to clear accumulators and trackers together with the plot data (Clear Accus, Trackers, Plots) or clear the plot data manually (Clear All from the plot's context menu).

## DC2334A SOFTWARE USER INTERFACE

### STATUS, ALERTS, MASKS

The LTC2947 uses several bits that display the status of the device and the measured quantities with respect to their thresholds. Whether or not an alert condition is communicated via the ALERTB pin can be selected by means of the MASK bits. These bits are shown in the Status, Alerts, Masks window:

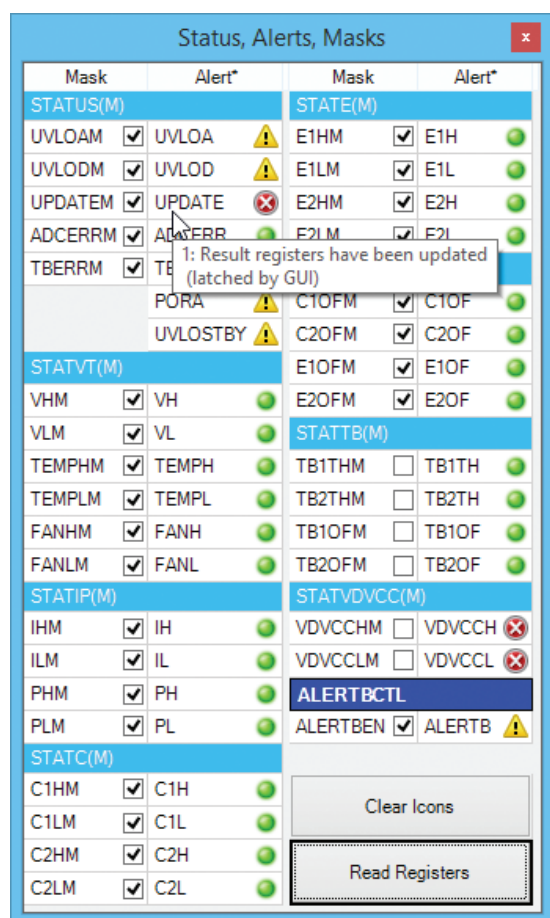

Figure 35. Status, Alerts, Masks: Current and Past Alerts Are Shown with Different Icons

Also shown here is the Alert Master Control Enable (ALERTBEN within register ALERTBCTL) bit and an emulated value of ALERTB pin state.

For instance, to unmask the Temperature High Alert and activate the alert of the temperature exceeding the threshold, deselect the TEMPHM bit.

All alert bits are cleared on read. The GUI therefore indicates their state by three different icons as shown in the following table:

Table 2. Alert State Symbols

ADCERR	No alert (even not during a past read)
UVLOD	Alert bit was set during a past read but not in the last read of the register (latched by the GUI)
UPDATE	Alert bit was set in the last read of the register

The warning symbol is a special feature of the GUI that also takes the history of the bit into account. It shows the bit was set at some previous read of the related register. This feature is especially helpful in case of a continuous measurement with Register Auto Read enabled. Any non-persistent alert condition would be reported very shortly and then disappear as it is cleared-on-read. The GUI will turn the cleared alert into a persistent (latched) warning symbol that is only cleared by clicking on Clear Icons.

The Mask registers control which Alerts trigger the ALERTB pin. If a Mask Register bit is reset to 0 (checkbox cleared), the dedicated alert causes the ALERTB pin to pull low if ALERTBEN is set to 1 (checkbox set).

The Alert Master Control register (ALERTBCTL) is highlighted with a different color to show that it controls the effect of all other bits. The DC2334A does not report the actual state of the ALERTB pin to the GUI. In typical applications the ALERTB pin will be connected to an interrupt line of a microcontroller. The GUI emulates the state of the pin by performing the same operation to all alerts as the LTC2947 would do: masking all alerts by the associated mask bits, making a wired-or of all the resulting bits and a wired-and together with the ALERTBEN bit. If the result is 1, the symbol next to ALERTB will be set to the X- or warning-symbol. This emulation works as long as Register Auto Read is enabled. In any case, the ALERT (LED1) LED on the DC2334A will always indicate the current state.



Figure 36. Alert Master Control Enable and Emulated ALERTB Pin State

## DC2334A SOFTWARE USER INTERFACE

If the Register Auto Read is not enabled, the current state may be read from the LTC2947 by clicking on Read Registers. This will only read registers STATUS to STATVDVCCM. To read all registers from the device, the function Update All Registers from Operation Control is used.

### REGISTER MAP

The Register Map allows direct access to all device Registers/Values. All data is shown in a table where each cell corresponds to a single-byte register or multiple-byte registers grouped to a single device value like charge, energy and current.

### EDIT REGISTER VALUES

Register values can be edited either by selecting a cell and typing a new value or by double clicking on the cell to modify the current value. New values are written to the LTC2947 after pressing enter or leaving the cell. An entered value may be discarded by pressing the Escape button.

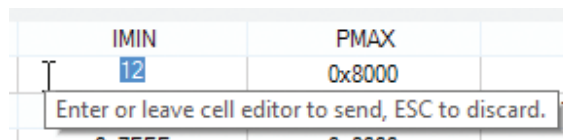

Figure 38. Cell/Register Editor

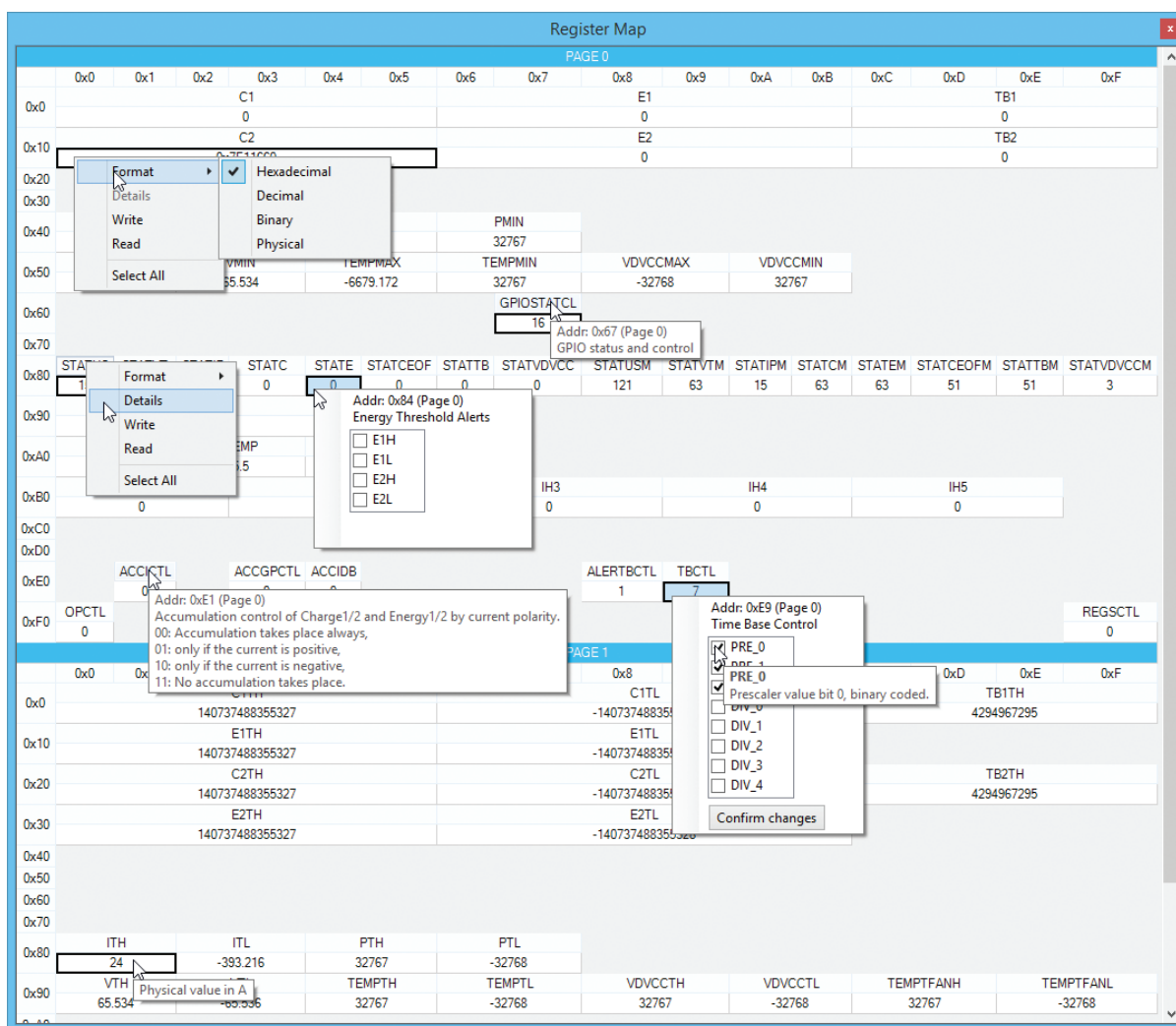

Figure 37. Register Map Function Overview

## DC2334A SOFTWARE USER INTERFACE

### REGISTER CONTEXT MENU

By clicking on any register header (e.g. STATUS) or right clicking on any register value (shown underneath the header), a context menu with the functions is shown:

1. Change cell's display format
2. Show cell/register details
3. Write cell/register value to device
4. Read cell/register value from device
5. Select all cells

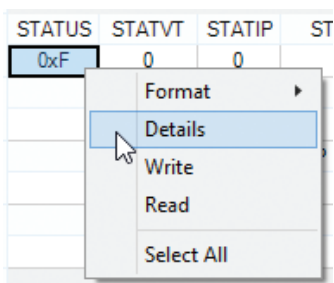

Figure 39. Cell/Register Context Menu

Format and Details will be explained in the following sections. The Write and Read command will immediately write or read the selected cell value to or from the device.

Select All will select all the cells. It is also possible to select a range of cells or some individual cells by using Ctrl or Shift key plus the mouse button. The procedure is the same as for other Windows programs like MS Excel, for example. The purpose of selecting more than one cell is to read and write or change the formats of several cells at once. See also the following section.

### DISPLAY FORMAT SELECTION

Each cell's display format may be set to either Hexadecimal, Decimal, Binary or Physical. The Physical format (in A, As, W, V, etc.) is only available for cells having a physical value representation as the measurement, tracking and threshold values.

The default cell format is Decimal. All cell values may be changed at once to the physical format, for example. This

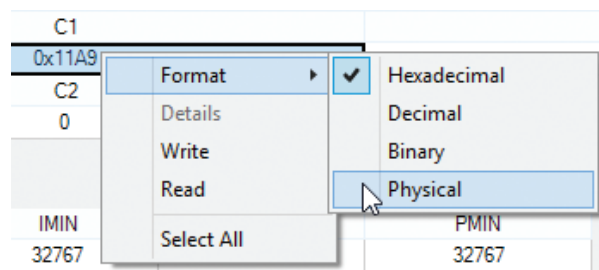

Figure 40. Display Format Selection

is done by first selecting all cells, either using the shift key plus mouse button or by using the Select All function from the context menu. Then right click on any of the selected cells to open the context menu and set the new format.

The binary and hexadecimal formats are indicated by a

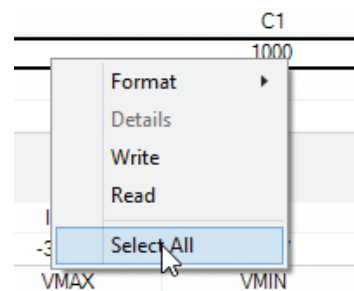

Figure 41. Select All Cells

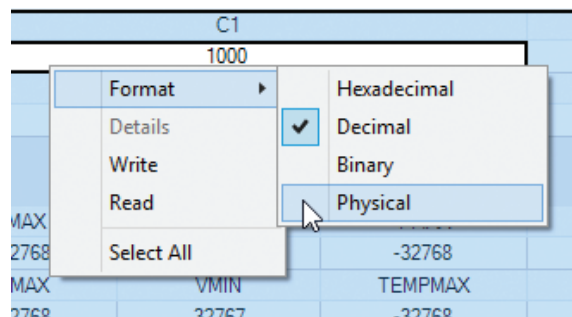

Figure 42. Change Format of All Selected Cells

Ob and 0x suffix. The physical and decimal format can be distinguished by the tooltip that is shown after the mouse has rested for a short while over the cell value. This tooltip will show the corresponding unit if it is a physical value or the corresponding LSB value for all the other formats.

# DC2334A SOFTWARE USER INTERFACE

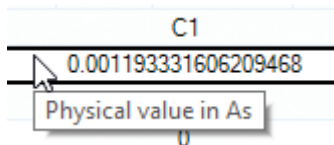

Figure 43. Physical Format Cell Value

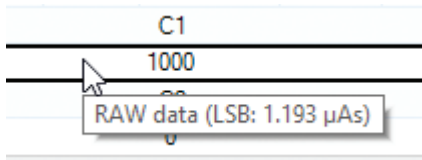

Figure 44. Decimal Format Cell Value

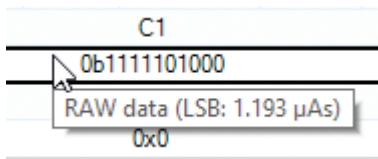

Figure 45. Binary Format Cell Value

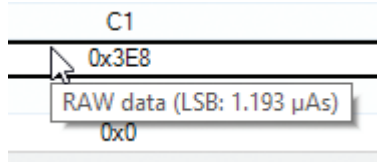

Figure 46. Hexadecimal Format Cell Value

## REGISTER MAP TOOLTIPS

The register map includes a lot of helpful information shown in tooltips. They appear after the mouse has rested for a short while over an element of the register map.

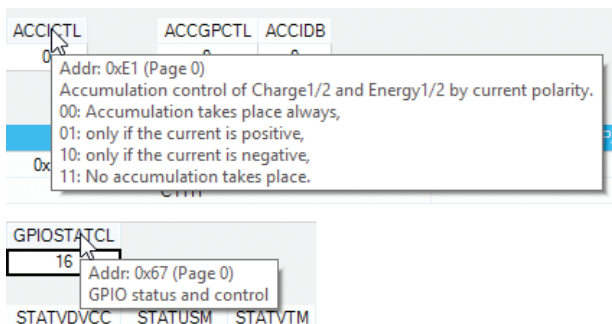

Figure 47. Tooltip of Register Name Showing Its Description

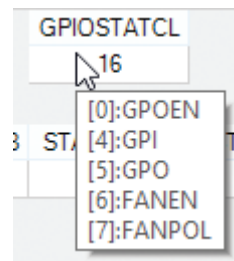

Figure 48. Tooltip of Cell Value Showing Bit Description

## REGISTER DETAILS

For registers that have bits assigned to functions, the register context menu provides access to a details view.

Figure 49 shows as an example the access to the details view of OPCTL. Click on the name OPCTL or right click on the cell value, select Details from context menu. All bits with defined functions are listed with check boxes next to them indicating if the corresponding bit is set or not. Tooltips show more detailed descriptions for each bit. Any changes may be performed by clicking on the check boxes. After clicking on Confirm changes the new value is assigned to the cell, still allowing to make changes to it. The new value will be written to the device after hitting the ENTER key or leaving the cell (e.g. clicking somewhere else in the register map).

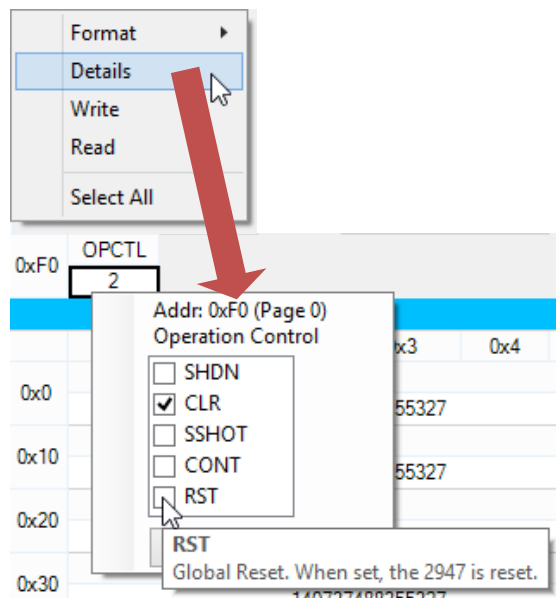

Figure 49. Register Details View

## DC2334A SOFTWARE USER INTERFACE

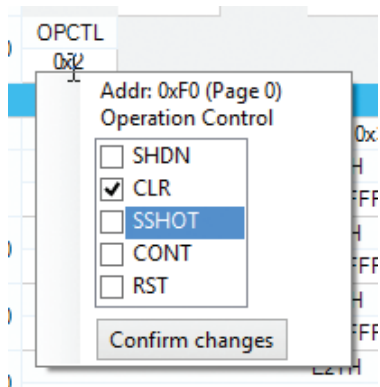

Figure 50. Register Details View

### AUTO READ MENU

The Auto Read menu allows users to specify which registers/values are read from the device if Register Auto Read is enabled. The update time may also be specified here.

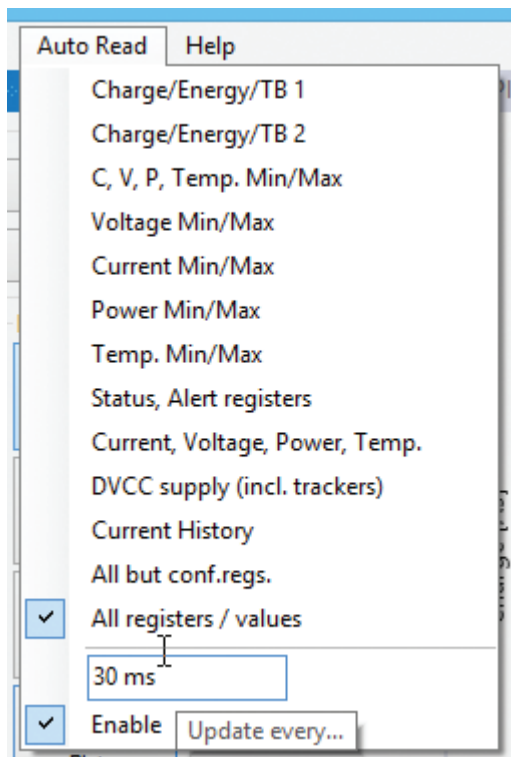

Figure 51. Auto Read Menu

Usually it is not necessary to make any configuration in this menu. Once Register Auto Read is clicked it will automatically make the configuration to read All Registers/Values and set the update time to 500ms.

The update time may be adjusted between 30ms and 10s. An error will be reported if the entered value is outside this range.

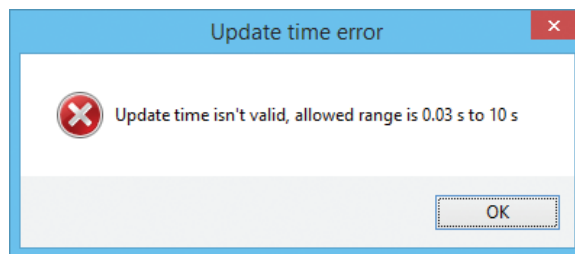

Figure 52. Update Time Error Report

In cases where only certain values are of interest, the checkbox next to All Registers/Values may be removed and other values, e.g. Current, Voltage, Power, Temp. may be set. It is then still possible to manually read other values from the Register Map.

### TOOLS MENU

The Tools menu provides access to a stand-alone TBC Calculator and to report functions that generate C-compliant source code for register, bit and LSB definitions.

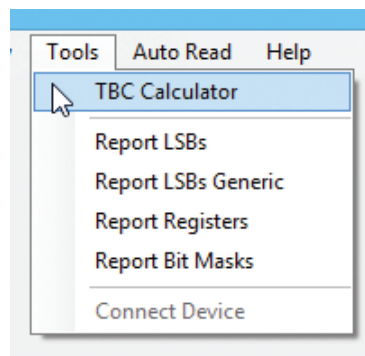

Figure 53. Tools Menu

## DC2334A SOFTWARE USER INTERFACE

The TBC calculator can be used to calculate different clock configurations without writing them to the device immediately. It is also possible to use this calculator without being connected to the device (the calculator in the Operation Control is not available in this case). The frequency may be entered in Hz, kHz, MHz. A new PRE/DIV pair will be calculated after hitting the ENTER or TAB key or by clicking on any other control within the window.

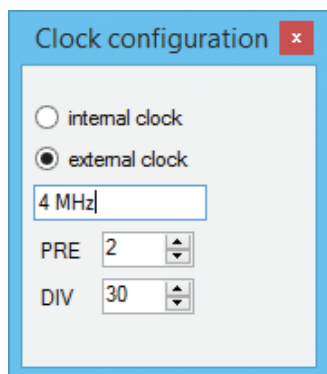

Figure 54. TBC Calculator

The Report functions allow users to generate C-compliant source code. The generated code can be copied to the Windows clipboard by clicking on To Clipboard and pasting into any source code text editor.

Report LSB will output fixed LSB definitions according to the current TBC configuration with the GUI.

Report LSBs Generic will output generic LSB definitions. The source code will have pre-set definitions of the current active TBC configuration that still may be adjusted afterwards to comply with other clock settings. See comments like, "...adjust here if necessary!" within the generated code.

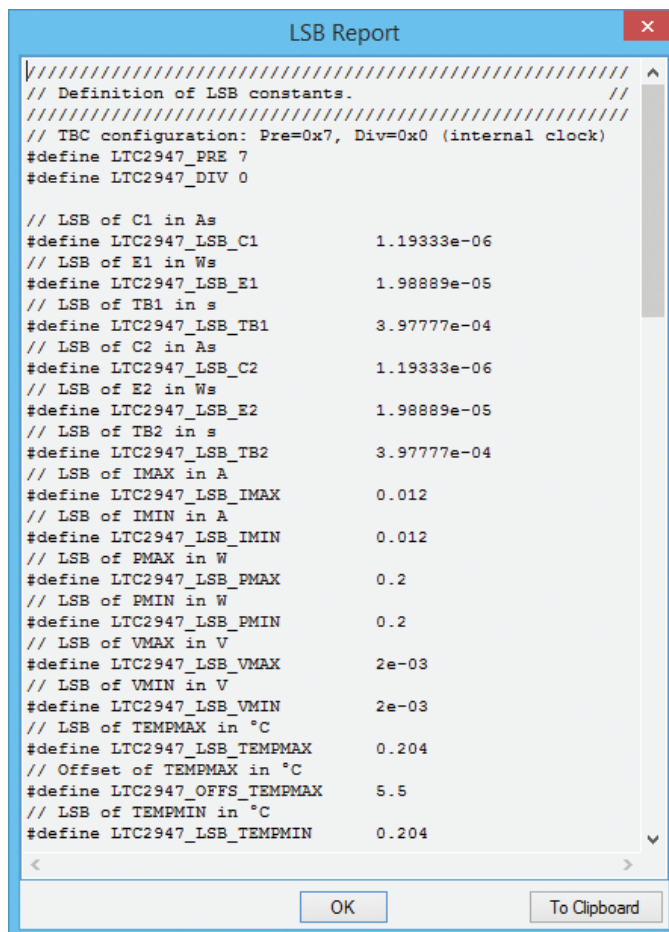

Figure 55. LSB Report

The Report Registers command will generate address definitions of all available single-byte registers and base addresses of multiple-byte device values. See comments within the source code for details.



## DC2334A SOFTWARE USER INTERFACE

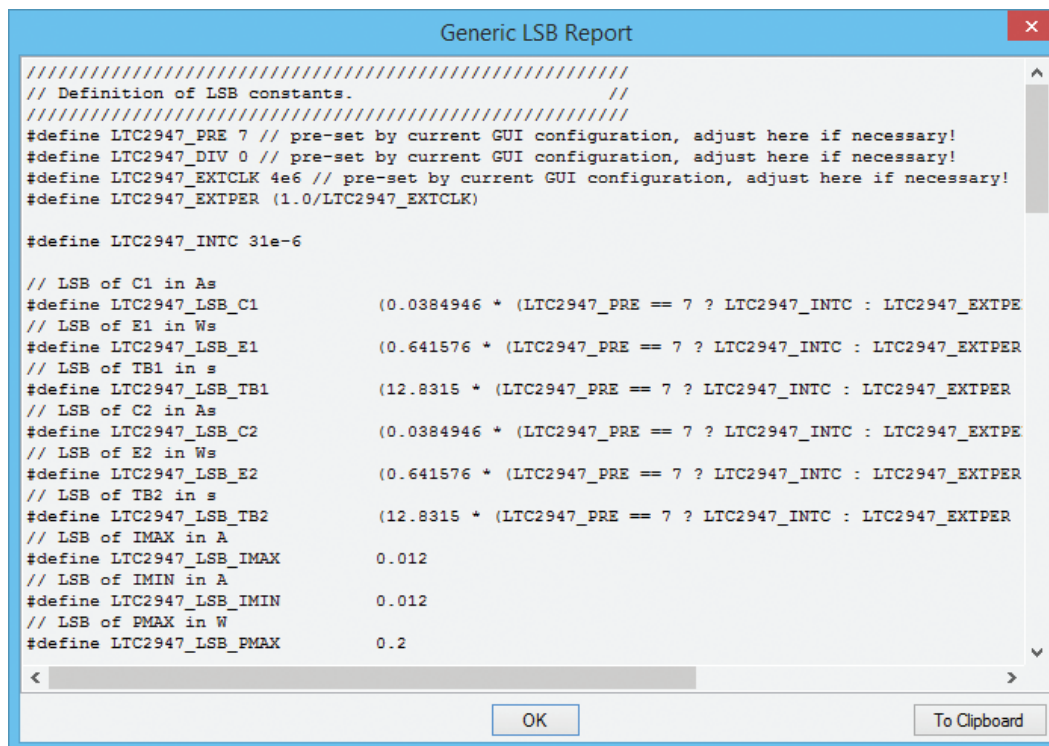

Figure 56. Generic LSB Report

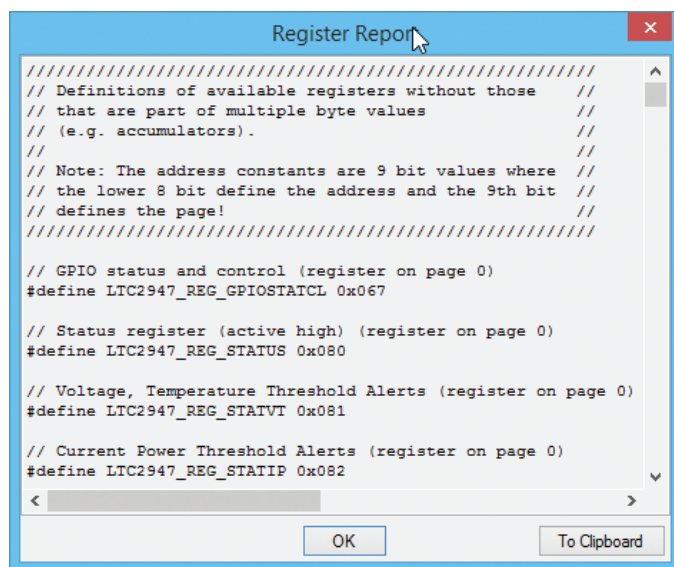

Figure 57. Register Report

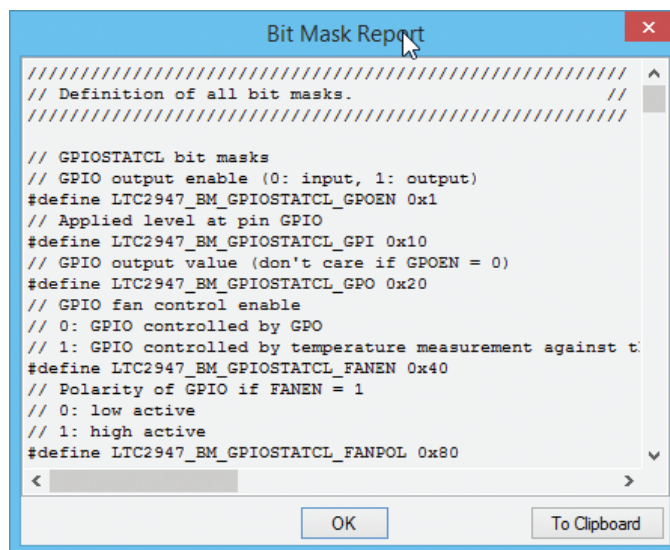

Figure 58. Bit Mask Report

The Report Bit Mask command will generate bit mask definitions of all functions assigned to bits. They can be used for test-bit, set-bit, clear-bit functions by performing bitwise operations.

See also the Linduino source code for the LTC2947 for details on how the generated code is used.

## APPENDIX

### LDO BETWEEN OVDD AND A/DVCC

The LDO LT1761 (U2) mainly serves as a current limiting/protected connection between OVDD and AVCC/DVCC. It is not necessary to operate the LTC2947 but eases the usage of the DC2334A.

The LDO's output voltage is set to guarantee the minimum supported operating voltage of AVCC/DVCC (>4.5V). Thanks to the LDO's reverse current protection, the user is always able to supply a higher voltage to AVCC/DVCC without worrying about conflicts to OVDD's operation range and setting of jumper JP2.

If the user accidentally sets a voltage < 4.5V to AVCC/DVCC and JP2 is set to OVDD, the LDO will limit the current to around 100mA. If this condition remains, the LDO will eventually go into thermal shutdown. This protection should at least prevent any irreparable damage to the DC2334A but it is not allowed to leave the board in such a condition for a long time.

The LT1761 has a maximum dropout voltage of 290mV at a load current of 10mA (worst case condition of LTC2947's AVCC/DVCC, typical value is much less). Thus, the minimum input voltage is 4.79V (for VOUT > 4.5V), which is normally ensured when operating the DC2334A with DC590/DC2026 and having their VCCIO configured to 5V.

The user is still able to set a lower voltage to OVDD either by using DC590 and setting jumper JP6, by using DC2026(B) and properly setting JP1 (and JP3) or by sourcing another voltage from his own application board. In this case, the user can supply A/DVCC from IP or an external connection to A/DVCC.

### TROUBLESHOOTING CONNECTION ERRORS

Several reasons might prevent the GUI (or QuikEval) from connecting to the DC2334A. The GUI tries to identify the demo circuit by going through all COM ports of the PC and sending commands that are recognized and answered

only by a DC590/DC2026. If, for some reason, any other program is accessing the COM ports, this could lead to a failure. In this case, try to close all other programs and restart the GUI directly from the Windows Start menu.

After the GUI finds the right COM port, it will try to identify the DC2334A by reading the onboard EEPROM. This will fail if the DC2334A is used as a shield on top of the Linduino. As described earlier, the GUI has to be started by the program menu entry in the Windows Start menu in such a configuration. When started manually (so not by QuikEval), the GUI will still perform the EEPROM check. The reason for doing this is to prevent the GUI from connecting to some other demo circuit from Linear Technology.

If the connection fails the first time, the GUI will show a window that asks if the DC2334A is connected as a shield. Answering yes will skip the EEPROM ID check. Make sure no other demo circuits are connected to the PC in this case, at least during start-up of the GUI. After the GUI has started it is still possible to use other demo circuits simultaneously. In case of a reconnection, the right LTC2947 demo circuit may then be defined in the Connect Device configuration window as described in the Operation Control section.

After the GUI establishes a connection to the DC2334A,

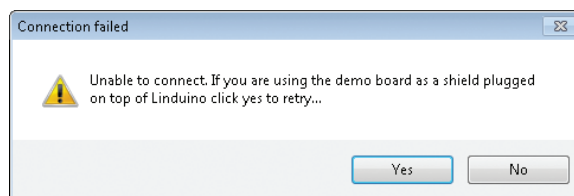

Figure 59. Linduino Shield Connection Failure Message

it will also try to communicate with the LTC2947 and perform some basic register access. As the GUI is not aware of the SPI/I<sup>2</sup>C jumper configuration, it will just try all possible combinations: first I<sup>2</sup>C with all possible slave addresses and finally SPI. If the SPI/I<sup>2</sup>C jumpers are set

## APPENDIX

to a non-allowed combination (e.g. configuring SPI by JP8 but setting JP5/JP6 to I<sup>2</sup>C or vice versa), the connection will fail. Remember, it is not possible to switch between I<sup>2</sup>C and SPI while the LTC2947 is powered up!

If the connection still fails, the Connection Error window might give some hints about the root cause.

Some hints within the error log could be:

```
11:47:41.982 | Info | Found 3 COM ports ([0]:COM14,[1]:COM12,[2]:COM13), will try to find device on these ports... | ComDC590
```

Is the COM port listed where DC590/DC2026 is expected?

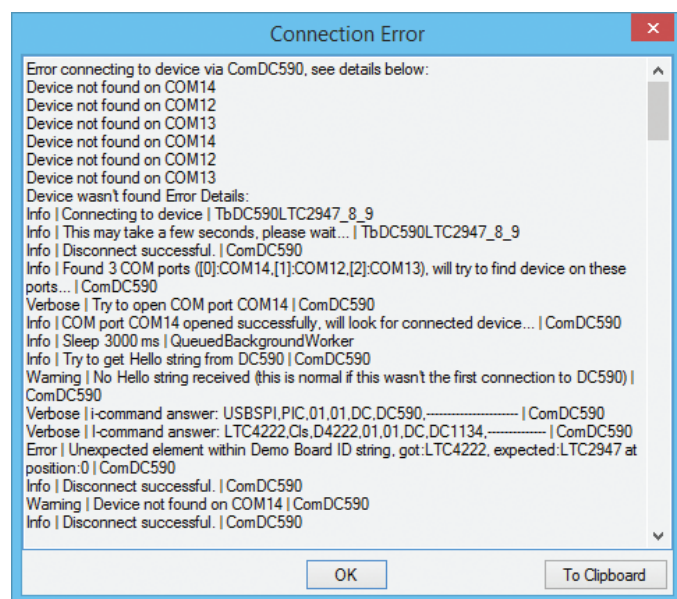

Figure 60. Connection Error Details View

```
Error | Unexpected element within Demo Board ID string, got:LTC4222, expected:LTC2947 at position:0 | ComDC590
```

Some other demo circuit is also connected to the PC. In most cases this is not a problem, as the GUI only checks the demo circuit's EEPROM ID and does not try to connect to any demo circuits other than DC2334A.

```
11:47:50.525 | Error | Couldn't talk to device via COM12 using I2C, slave address:0x5C | LTC2947_8_9
11:47:50.716 | Error | Couldn't talk to device via COM12 using I2C, slave address:0x5D | LTC2947_8_9
...
```

```
11:47:51.642 | Error | Couldn't talk to device via COM12 using SPI | LTC2947_8_9
```

Something is wrong with the serial interface configuration, see JP5/JP6. Also, remember that in the Linduino Shield operation mode only I<sup>2</sup>C is allowed.

```
11:47:56.857 | Error | Com ReadLine failed:The operation has timed out. | ComDC590
11:47:56.857 | Error | Failed to get Demo Board ID string | ComDC590
11:47:56.857 | Error | Unexpected length of Demo Board ID string, got:0, expected:8 | ComDC590
```

Those messages will appear if the DC2334A is used as a Linduino shield and the GUI is not aware of it. Make sure to reply with yes to the message window shown in Figure 59.

## SCHEMATIC DIAGRAM

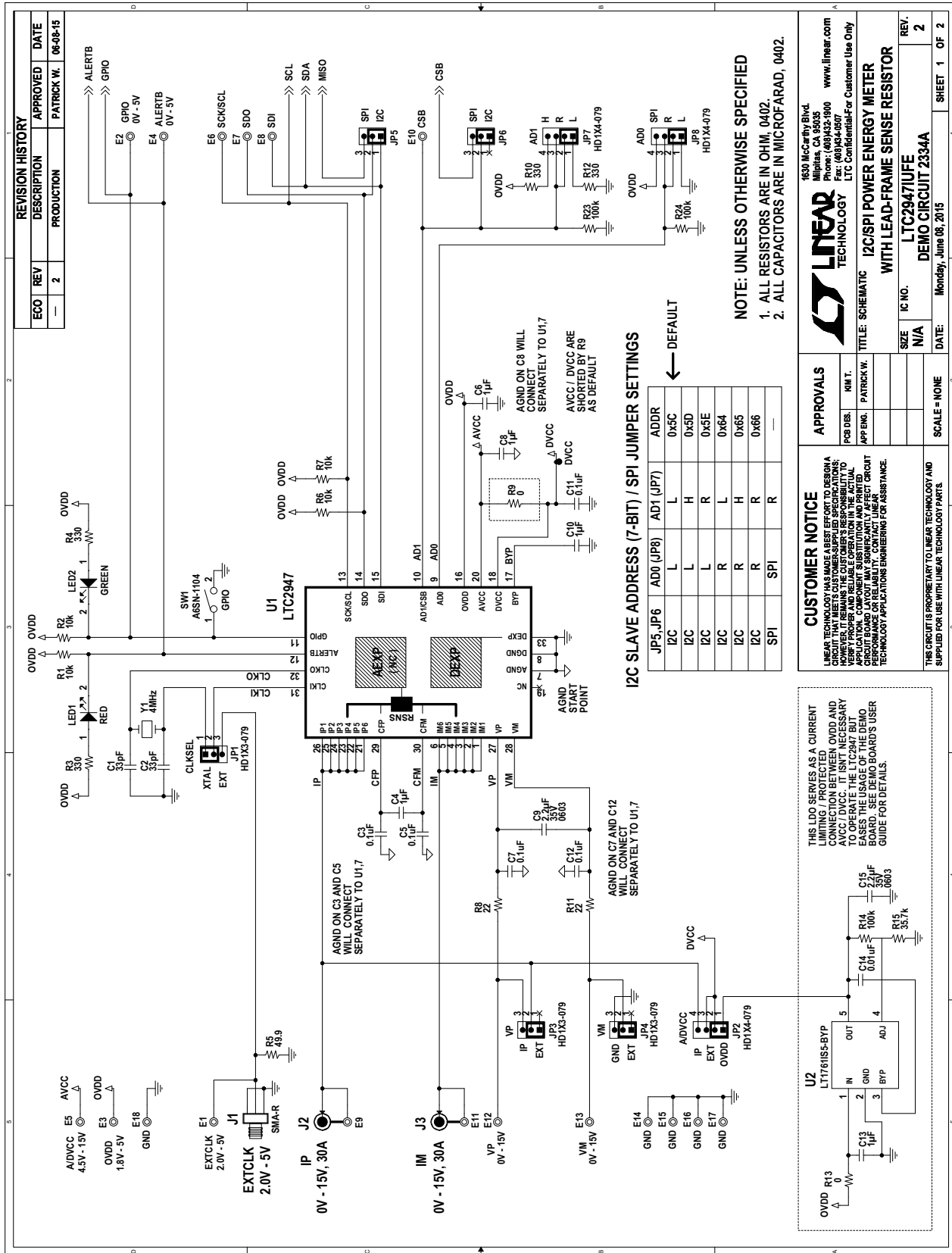

**SCHEMATIC DIAGRAM**

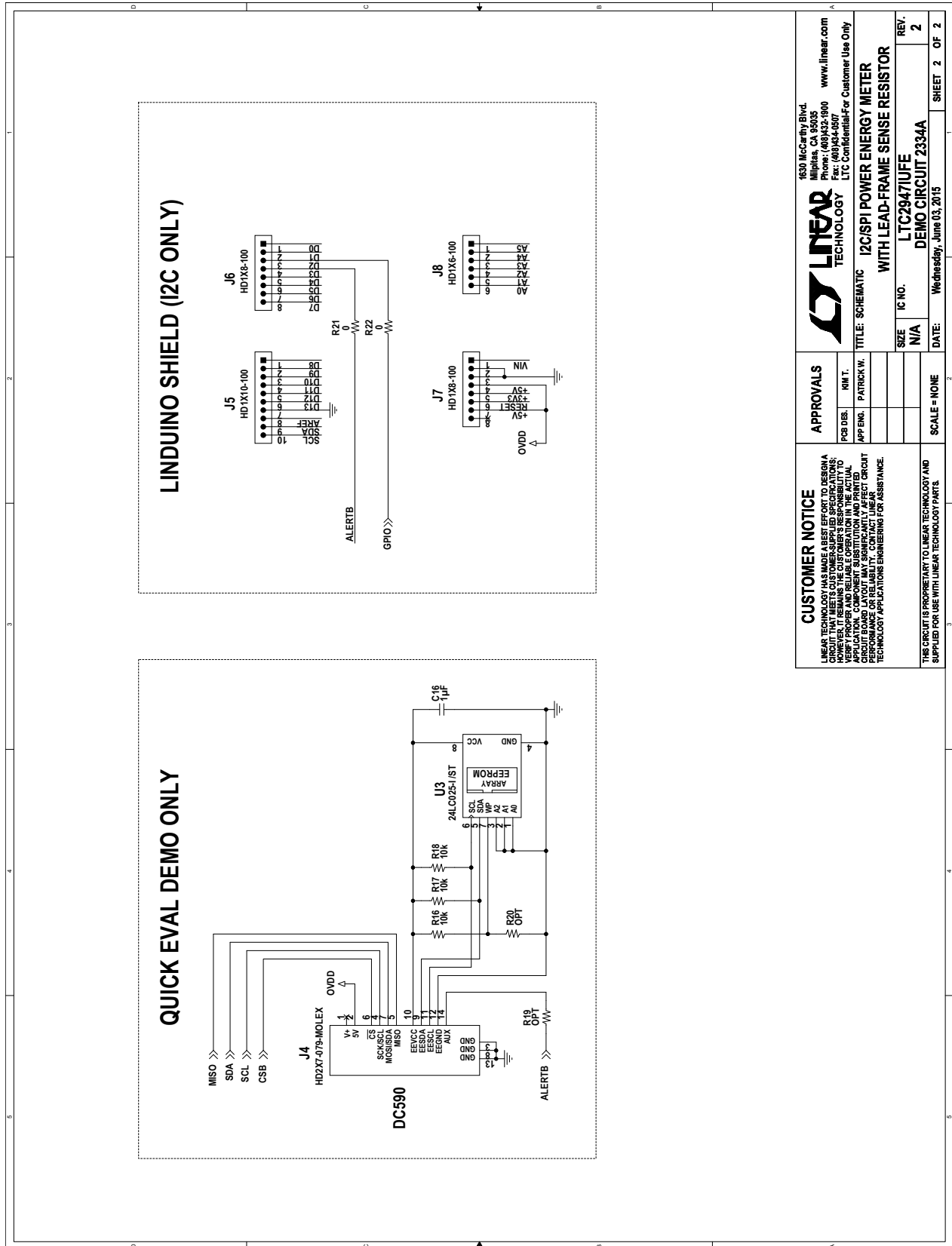

<b>APPROVALS</b> POB DES: KIM T. APP ENG: PATRICK W.		<b>CUSTOMER NOTICE</b> LINEAR TECHNOLOGY HAS MADE A BEST EFFORT TO DESIGN A CIRCUIT THAT MEETS OUR CUSTOMER-SUPPLIED SPECIFICATIONS. THE USER MUST VERIFY PROPER AND RELIABLE OPERATION IN THE ACTUAL APPLICATION. COMPONENT SUBSTITUTION AND PRINTED BOARD CHANGES MAY AFFECT PERFORMANCE OR RELIABILITY. CONTACT LINEAR TECHNOLOGY APPLICATIONS ENGINEERING FOR ASSISTANCE.	
TITLE: SCHEMATIC WITH LEAD-FRAME SENSE RESISTOR		IC NO. LTC2947IUFE DEMO CIRCUIT 2334A	
SIZE: N/A DATE: Wednesday, June 03, 2015		SCALE: NONE SHEET 2 OF 2	
1630 McCarthy Blvd. Milpitas, CA 95035 Phone: (408)432-1900 Fax: (408)434-0077 www.linear.com LIT Confidential-For Customer Use Only		REV. 2	

# DEMO MANUAL DC2334A

---

## DEMONSTRATION BOARD IMPORTANT NOTICE

Linear Technology Corporation (LTC) provides the enclosed product(s) under the following **AS IS** conditions:

This demonstration board (DEMO BOARD) kit being sold or provided by Linear Technology is intended for use for **ENGINEERING DEVELOPMENT OR EVALUATION PURPOSES ONLY** and is not provided by LTC for commercial use. As such, the DEMO BOARD herein may not be complete in terms of required design-, marketing-, and/or manufacturing-related protective considerations, including but not limited to product safety measures typically found in finished commercial goods. As a prototype, this product does not fall within the scope of the European Union directive on electromagnetic compatibility and therefore may or may not meet the technical requirements of the directive, or other regulations.

If this evaluation kit does not meet the specifications recited in the DEMO BOARD manual the kit may be returned within 30 days from the date of delivery for a full refund. **THE FOREGOING WARRANTY IS THE EXCLUSIVE WARRANTY MADE BY THE SELLER TO BUYER AND IS IN LIEU OF ALL OTHER WARRANTIES, EXPRESSED, IMPLIED, OR STATUTORY, INCLUDING ANY WARRANTY OF MERCHANTABILITY OR FITNESS FOR ANY PARTICULAR PURPOSE. EXCEPT TO THE EXTENT OF THIS INDEMNITY, NEITHER PARTY SHALL BE LIABLE TO THE OTHER FOR ANY INDIRECT, SPECIAL, INCIDENTAL, OR CONSEQUENTIAL DAMAGES.**

The user assumes all responsibility and liability for proper and safe handling of the goods. Further, the user releases LTC from all claims arising from the handling or use of the goods. Due to the open construction of the product, it is the user's responsibility to take any and all appropriate precautions with regard to electrostatic discharge. Also be aware that the products herein may not be regulatory compliant or agency certified (FCC, UL, CE, etc.).

No License is granted under any patent right or other intellectual property whatsoever. **LTC assumes no liability for applications assistance, customer product design, software performance, or infringement of patents or any other intellectual property rights of any kind.**

LTC currently services a variety of customers for products around the world, and therefore this transaction **is not exclusive**.

**Please read the DEMO BOARD manual prior to handling the product.** Persons handling this product must have electronics training and observe good laboratory practice standards. **Common sense is encouraged.**

This notice contains important safety information about temperatures and voltages. For further safety concerns, please contact a LTC application engineer.

Mailing Address:

Linear Technology  
1630 McCarthy Blvd.  
Milpitas, CA 95035

Copyright © 2004, Linear Technology Corporation

dc2334af