

MS8038-H series

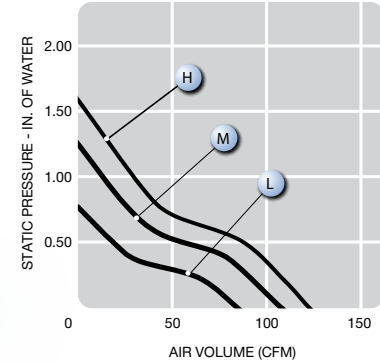
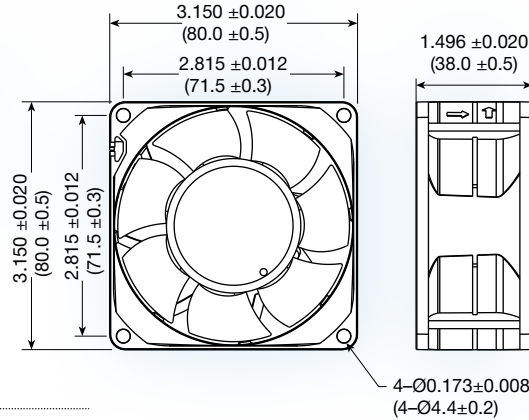

(80 x 80 x 38 mm)

3.15 x 3.15 x 1.50 inches

Features: soft start, polarity protection, auto-restart

Operating Voltage: 12, 24 and 48 VDC

Construction: UL94V-0 plastic impeller and plastic frame

Bearing option: ball bearing

Air Flow: air exhaust over struts

Options:

- tachometer;
- locked rotor alarm signal;
- PWM speed control;
- conformal coating;
- encapsulated motor (IP68)



Model No.	Rated Voltage VDC	Current A			Speed RPM	Air Volume		Max. Static Pressure (H ₂ O)		Sound Noise dbA	Weight g
		12	24	48		M ³ /Min.	CFM	MM	INCH		
MS8038L-H	12/24/48	0.60	0.30	0.17	6,000	2.28	80.6	18.70	0.74	50	177
MS8038M-H	12/24/48	1.47	0.78	0.34	8,000	3.10	109.6	31.10	1.22	59	177
MS8038H-H	12/24/48	3.29	1.15	0.51	9,000	3.41	120.6	39.38	1.55	62	177

*Additional performance levels available, contact Mechatronics for more options